

DATA SHEET

# SMV1405-SMV1413 Series: Plastic Packaged Abrupt Junction Tuning Varactors

## Applications

- High-Q resonators in wireless system VCOs
- High volume commercial systems

## Features

- High Q
- Low series resistance for low phase noise
- Packages rated MSL1, 260 °C per JEDEC J-STD-020







Skyworks offers lead (Pb)-free, RoHS (Restriction of Hazardous Substances) compliant packaging.

## Description

The SMV1405-SMV1413 group of silicon abrupt junction varactor diodes is designed for use in Voltage Controlled Oscillators (VCOs) requiring tight capacitance tolerances. The low resistance of these varactors makes them appropriate for high-Q resonators in wireless system VCOs to frequencies above 2.5 GHz. This family of varactors is characterized for capacitance over temperature.

Table 1 describes the various packages and markings of the SMV1405-SMV1413 group of varactors.

**Table 1. Packaging and Marking**

			
Single	Single	Common Cathode	Common Cathode
SC-79	SOT-23	SOT-23	SC-70
<b>SMV1405-079LF</b> Marking: Cathode			<b>SMV1405-074</b> Marking: BE3
	<b>SMV1408-001</b> Marking: VV1		<b>SMV1405-074LF</b> Marking: GE3
	<b>SMV1408-001LF</b> Marking: DV1		
	<b>SMV1413-001</b> Marking: AR1	<b>SMV1413-004</b> Marking: AR3	
<b>SMV1413-079LF</b> Marking: Cathode	<b>SMV1413-001LF</b> Marking: ER1	<b>SMV1413-004LF</b> Marking: ER3	<b>SMV1413-074LF</b> Marking: ER3
Ls = 0.7 nH	Ls = 1.5 nH	Ls = 1.5 nH	Ls = 1.4 nH



LF denotes lead (Pb)-free, RoHS-compliant packaging option as an alternative to the standard Skyworks tin/lead (Sn/Pb) packaging.

**Table 2. SMV1405-SMV1413 Series Absolute Maximum Ratings**

Parameter	Symbol	Minimum	Typical	Maximum	Units
Reverse voltage	$V_R$			30	V
Forward current	$I_F$			20	mA
Power dissipation	$P_{DIS}$			250	mW
Operating temperature	$T_{OP}$	-55		+125	°C
Storage temperature	$T_{STG}$	-55		+150	°C

**Note:** Exposure to maximum rating conditions for extended periods may reduce device reliability. There is no damage to device with only one parameter set at the limit and all other parameters set at or below their nominal value. Exceeding any of the limits listed here may result in permanent damage to the device.

**CAUTION:** Although this device is designed to be as robust as possible, Electrostatic Discharge (ESD) can damage this device. This device must be protected at all times from ESD. Static charges may easily produce potentials of several kilovolts on the human body or equipment, which can discharge without detection. Industry-standard ESD precautions should be used at all times. The SMV1405-SMV1413 group of varactors are Class 0 Human Body Model (HBM) ESD devices.

**Table 3. SMV1405-SMV1413 Series Electrical Specifications (Note 1)**  
( $T_{OP} = 25\text{ °C}$ , Unless Otherwise Noted)

Part Number	$C_T @ 0.5\text{ V}$ (pF)	$C_T @ 1\text{ V}$ (pF)	$C_T @ 4\text{ V}$ (pF)		$\frac{C_T @ 0\text{ V}}{C_T @ 30\text{ V}}$ (Ratio)	$R_S @ 4\text{ V},$ 500 MHz ( $\Omega$ )	$Q @ 4\text{ V},$ 50 MHz
	Typ.	Typ.	Min.	Max.	Min	Max.	Typ.
SMV1405	2.1	1.8	1.21	1.45	4.1	0.8	3200
SMV1408	3.4	2.9	1.75	2.11	4.1	0.6	2900
SMV1413	7.4	6.4	3.64	4.42	4.2	0.35	2400

**Note 1:** Performance is guaranteed only under the conditions listed in this Table and is not guaranteed over the full operating or storage temperature ranges. Operation at elevated temperatures may reduce reliability of the device.

Reverse voltage  $V_R$  ( $I_R = 10\ \mu\text{A}$ ) = 30 V minimum  
Reverse current  $I_R$  ( $V_R = 24\text{ V}$ ) = 20 nA maximum

### Electrical and Mechanical Specifications

The absolute maximum ratings of the SMV1405-SMV1413 varactors are provided in Table 2. Electrical specifications are provided in Table 3. Typical capacitance values are listed in Table 4. Typical performance characteristics of the SMV1405-SMV1413 varactors are illustrated in Figures 1 and 2.

The SPICE model for the SMV1405-SMV1413 varactors is shown in Figure 3 and the associated model parameters are provided in Table 5.

Package dimensions are shown in Figures 4 to 8 (even numbers), and tape and reel dimensions are provided in Figures 5 to 9 (odd numbers).

### Package and Handling Information

Instructions on the shipping container label regarding exposure to moisture after the container seal is broken must be followed.

Otherwise, problems related to moisture absorption may occur when the part is subjected to high temperature during solder assembly.

The SMV1405-SMV1413 series of varactors are rated to Moisture Sensitivity Level 1 (MSL1) at 260 °C. They can be used for lead or lead-free soldering. For additional information, refer to the Skyworks Application Note, *Solder Reflow Information*, document number 200164

Care must be taken when attaching this product, whether it is done manually or in a production solder reflow environment. Production quantities of this product are shipped in a standard tape and reel format. For packaging details, refer to the Skyworks Application Note *Discrete Devices and IC Switch/Attenuators Tape and Reel Package Orientation*, document number 200083.

**Table 4. Capacitance vs Reverse Voltage**

V <sub>R</sub> (V)	C <sub>T</sub> (pF)		
	SMV1405	SMV1408	SMV1413
0	2.67	4.08	9.24
0.5	2.12	3.36	7.39
1.0	1.84	2.94	6.37
1.5	1.70	2.60	5.71
2.0	1.55	2.38	5.22
2.5	1.44	2.24	4.85
3.0	1.34	2.08	4.55
4.0	1.25	1.88	4.10
5.0	1.17	1.72	3.77
10.0	0.95	1.28	2.85
20.0	0.77	1.01	2.12
30.0	0.63	0.95	1.77

**Typical Performance Characteristics**

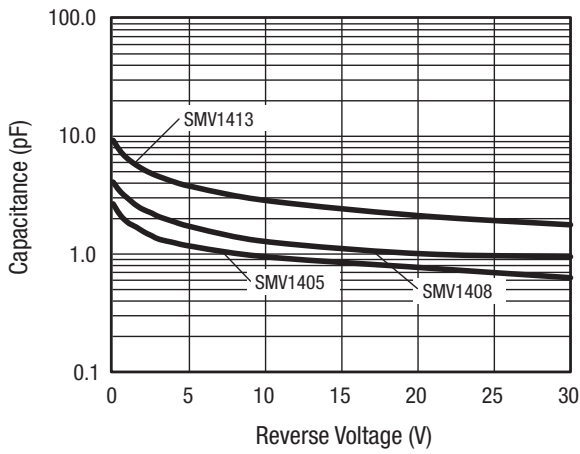

**Figure 1. Capacitance vs Reverse Voltage**

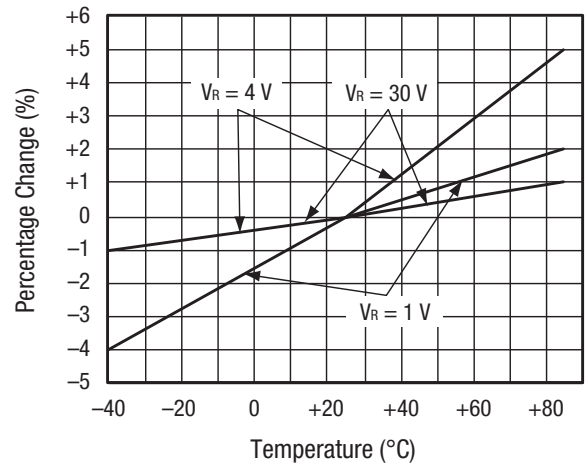

**Figure 2. Relative Capacitance Change vs Temperature**



Figure 3. SPICE Model

Table 5. SPICE Model Parameters

Part Number	C <sub>J0</sub> (pF)	V <sub>J</sub> (V)	M	C <sub>P</sub> (pF)	R <sub>S</sub> (Ω)
SMV1405	2.92	0.68	0.41	0.05	0.80
SMV1408	3.70	0.80	0.48	0.13	0.60
SMV1413	9.20	0.79	0.45	0.13	0.35

Values extracted from measured performance.

For package inductance (L<sub>s</sub>, refer to Table 1.

For more details, refer to the Skyworks Application Note, *Varactor SPICE Model for Approved RF VCO Applications*, document number 200315.

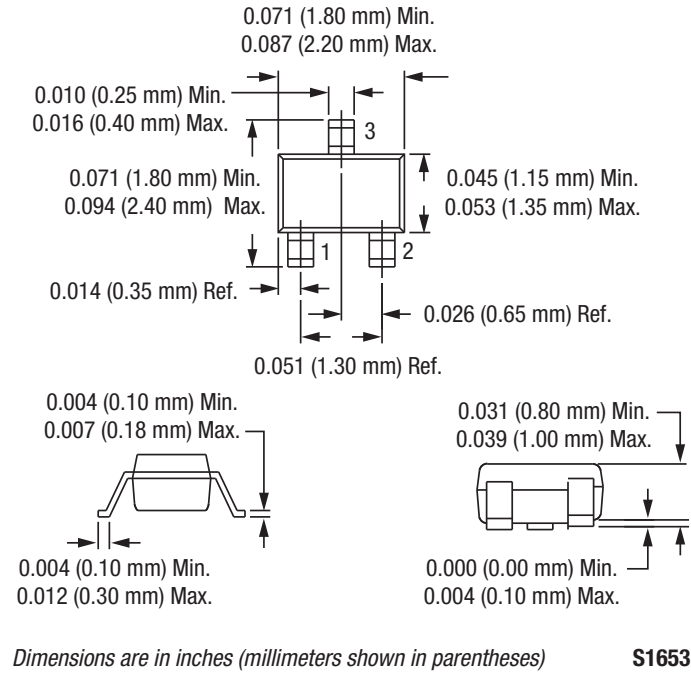

Figure 4. SC-70 Package Dimensions

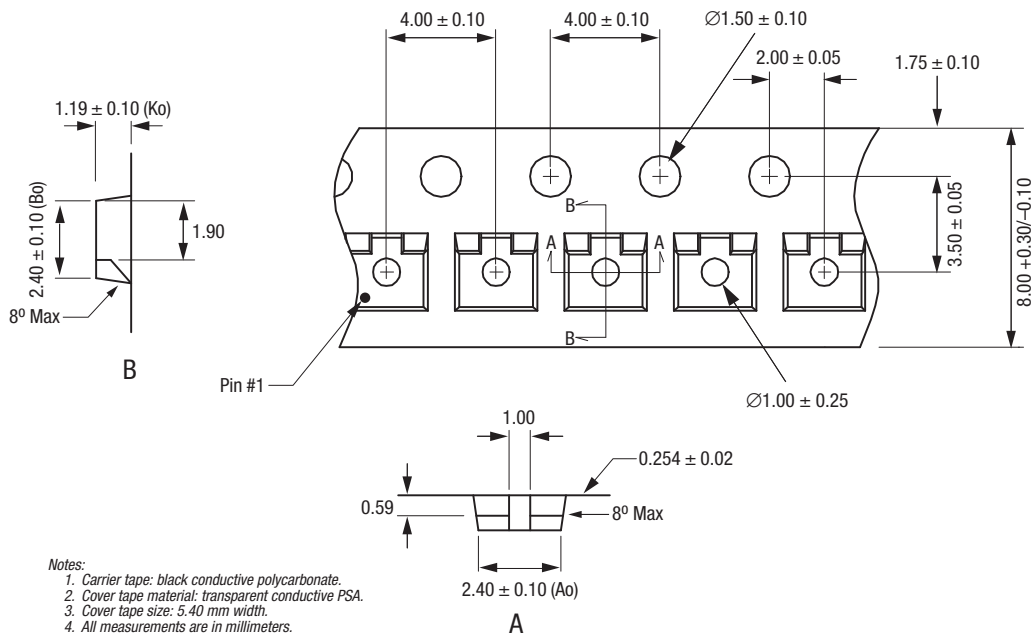
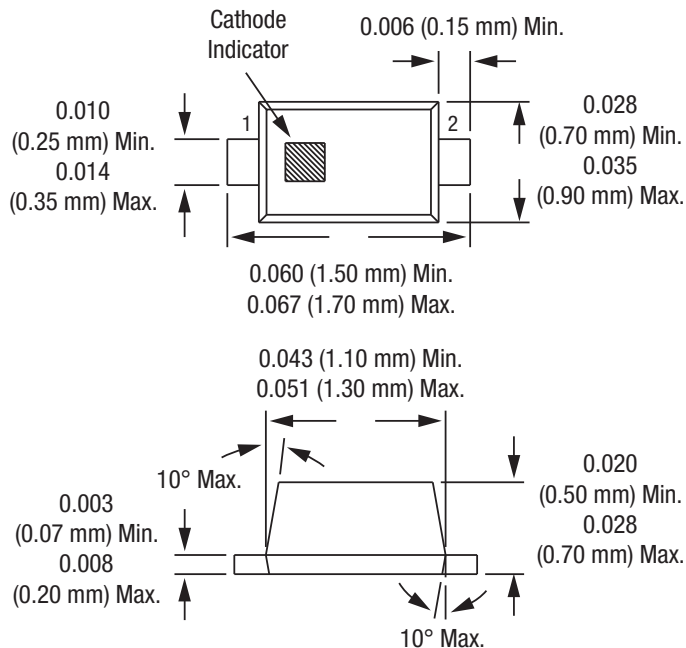
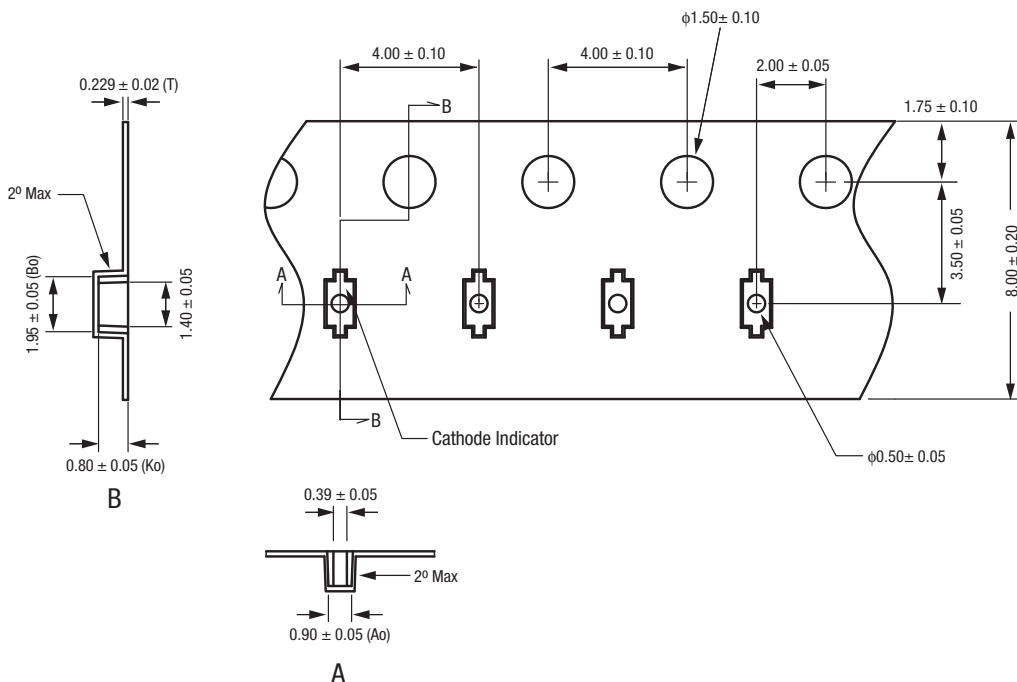

Figure 5. SC-70 Tape and Reel Dimensions



Dimensions are in inches (millimeters shown in parentheses) S1652

Figure 6. SC-79 Package Dimensions



- Notes:
1. Carrier tape: black conductive polycarbonate or polystyrene.
  2. Cover tape material: transparent conductive PSA.
  3. Cover tape size: 5.4 mm width.
  4. All measurements are in millimeters.

S1673

Figure 7. SC-79 Tape and Reel Dimensions



Copyright © 2002-2007, 2009 Skyworks Solutions, Inc. All Rights Reserved.

Information in this document is provided in connection with Skyworks Solutions, Inc. ("Skyworks") products or services. These materials, including the information contained herein, are provided by Skyworks as a service to its customers and may be used for informational purposes only by the customer. Skyworks assumes no responsibility for errors or omissions in these materials or the information contained herein. Skyworks may change its documentation, products, services, specifications or product descriptions at any time, without notice. Skyworks makes no commitment to update the materials or information and shall have no responsibility whatsoever for conflicts, incompatibilities, or other difficulties arising from any future changes.

No license, whether express, implied, by estoppel or otherwise, is granted to any intellectual property rights by this document. Skyworks assumes no liability for any materials, products or information provided hereunder, including the sale, distribution, reproduction or use of Skyworks products, information or materials, except as may be provided in Skyworks Terms and Conditions of Sale.

THE MATERIALS, PRODUCTS AND INFORMATION ARE PROVIDED "AS IS" WITHOUT WARRANTY OF ANY KIND, WHETHER EXPRESS, IMPLIED, STATUTORY, OR OTHERWISE, INCLUDING FITNESS FOR A PARTICULAR PURPOSE OR USE, MERCHANTABILITY, PERFORMANCE, QUALITY OR NON-INFRINGEMENT OF ANY INTELLECTUAL PROPERTY RIGHT; ALL SUCH WARRANTIES ARE HEREBY EXPRESSLY DISCLAIMED. SKYWORKS DOES NOT WARRANT THE ACCURACY OR COMPLETENESS OF THE INFORMATION, TEXT, GRAPHICS OR OTHER ITEMS CONTAINED WITHIN THESE MATERIALS. SKYWORKS SHALL NOT BE LIABLE FOR ANY DAMAGES, INCLUDING BUT NOT LIMITED TO ANY SPECIAL, INDIRECT, INCIDENTAL, STATUTORY, OR CONSEQUENTIAL DAMAGES, INCLUDING WITHOUT LIMITATION, LOST REVENUES OR LOST PROFITS THAT MAY RESULT FROM THE USE OF THE MATERIALS OR INFORMATION, WHETHER OR NOT THE RECIPIENT OF MATERIALS HAS BEEN ADVISED OF THE POSSIBILITY OF SUCH DAMAGE.

Skyworks products are not intended for use in medical, lifesaving or life-sustaining applications, or other equipment in which the failure of the Skyworks products could lead to personal injury, death, physical or environmental damage. Skyworks customers using or selling Skyworks products for use in such applications do so at their own risk and agree to fully indemnify Skyworks for any damages resulting from such improper use or sale.

Customers are responsible for their products and applications using Skyworks products, which may deviate from published specifications as a result of design defects, errors, or operation of products outside of published parameters or design specifications. Customers should include design and operating safeguards to minimize these and other risks. Skyworks assumes no liability for applications assistance, customer product design, or damage to any equipment resulting from the use of Skyworks products outside of stated published specifications or parameters.

Skyworks, the Skyworks symbol, and "Breakthrough Simplicity" are trademarks or registered trademarks of Skyworks Solutions, Inc., in the United States and other countries. Third-party brands and names are for identification purposes only, and are the property of their respective owners. Additional information, including relevant terms and conditions, posted at [www.skyworksinc.com](http://www.skyworksinc.com), are incorporated by reference.