

**OBSOLETE PRODUCT
FOR A POSSIBLE SUBSTITUTE PRODUCT**
 contact our Technical Support Center at
 1-888-INTERSIL or www.intersil.com/tsc

May 14, 2008

FN7504.7

**micropower Single Supply Rail-to-Rail
Input-Output (RRIO) Precision Op Amp**

The EL8178 is a precision low power, operational amplifier. The device is optimized for single supply operation between 2.4V to 5.5V. This enables operation from one lithium cell or two Ni-Cd batteries. The input range includes both positive and negative rail.

For power sensitive applications, the EL8178 has an $\overline{\text{EN}}$ pin that will shut the device down and reduce the supply current to 3 μA typ. In the active state, the EL8178 draws minimal supply current (55 μA) while meeting excellent DC-accuracy, noise, and output drive specifications.

Ordering Information

PART NUMBER (Note 1)	PART MARKING	PACKAGE (Pb-Free)	PKG. DWG. #
EL8178FWZ-T7*	BBWA	6 Ld SOT-23	MDP0038
EL8178FWZ-T7A*	BBWA	6 Ld SOT-23	MDP0038
EL8178FSZ	8178FSZ	8 Ld SO	MDP0027
EL8178FSZ-T7*	8178FSZ	8 Ld SO	MDP0027

*Please refer to TB347 for details on reel specifications.
NOTE:

- These Intersil Pb-free plastic packaged products employ special Pb-free material sets; molding compounds/die attach materials and 100% matte tin plate PLUS ANNEAL - e3 termination finish, which is RoHS compliant and compatible with both SnPb and Pb-free soldering operations. Intersil Pb-free products are MSL classified at Pb-free peak reflow temperatures that meet or exceed the Pb-free requirements of IPC/JEDEC J STD-020.

Features

- Typical 55 μA supply current
- 250 μV max offset voltage
- Typical 1pA input bias current
- 266kHz gain-bandwidth product
- Single supply operation between 2.4V to 5.5V
- Rail-to-rail input and output
- Ground sensing
- Output sources and sinks 26mA load current
- Pb-free (RoHS compliant)

Applications

- Battery- or solar-powered systems
- 4mA to 20mA current loops
- Handheld consumer products
- Medical devices
- Thermocouple amplifiers
- Photodiode pre-amps
- pH probe amplifiers

Pinouts

**EL8178
(6 LD SOT-23)
TOP VIEW**

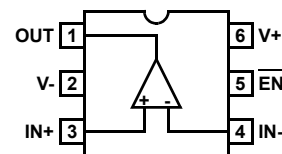

**EL8178
(8 LD SO)
TOP VIEW**

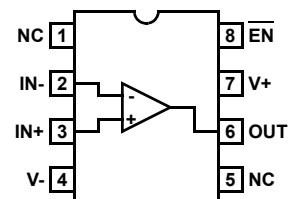

Absolute Maximum Ratings ($T_A = +25^\circ\text{C}$)

Supply Voltage (V_S) and Pwr-up Ramp Rate	5.75V, 1V/ μs
Differential Input Voltage	0.5V
Current into IN+, IN-, and $\overline{\text{EN}}$	5mA
Input Voltage	V- - 0.5V to V+ + 0.5V
ESD Tolerance	
Human Body Model	3kV
Machine Model	300V

Thermal Information

Thermal Resistance (Typical, Note 2)	θ_{JA} ($^\circ\text{C}/\text{W}$)
6 Ld SOT-23 Package	230
8 Ld SO Package	125
Ambient Operating Temperature Range	-40 $^\circ\text{C}$ to +125 $^\circ\text{C}$
Storage Temperature Range	-65 $^\circ\text{C}$ to +150 $^\circ\text{C}$
Operating Junction Temperature	+125 $^\circ\text{C}$
Pb-free reflow profile	see link below
	http://www.intersil.com/pbfree/Pb-FreeReflow.asp

CAUTION: Do not operate at or near the maximum ratings listed for extended periods of time. Exposure to such conditions may adversely impact product reliability and result in failures not covered by warranty.

NOTES:

- θ_{JA} is measured with the component mounted on a high effective thermal conductivity test board in free air. See Tech Brief TB379 for details.

IMPORTANT NOTE: All parameters having Min/Max specifications are guaranteed. Typical values are for information purposes only. Unless otherwise noted, all tests are at the specified temperature and are pulsed tests, therefore: $T_J = T_C = T_A$

Electrical Specifications $V_+ = 5\text{V}$, $V_- = 0\text{V}$, $V_{CM} = 2.5\text{V}$, $V_O = 2.5\text{V}$, $T_A = +25^\circ\text{C}$ unless otherwise specified. **Boldface limits** apply over the operating temperature range, **-40 $^\circ\text{C}$ to +125 $^\circ\text{C}$** .

PARAMETER	DESCRIPTION	TEST CONDITIONS	MIN (Note 3)	TYP	MAX (Note 3)	UNIT
V_{OS}	Input Offset Voltage		-250	50	250	μV
			-450		450	μV
$\frac{\Delta V_{OS}}{\Delta \text{Time}}$	Long Term Input Offset Voltage Stability			3		$\mu\text{V}/\text{Mo}$
$\frac{\Delta V_{OS}}{\Delta T}$	Input Offset Drift vs Temperature			1.1		$\mu\text{V}/^\circ\text{C}$
I_B	Input Bias Current		-25	1	25	pA
			-600		600	pA
I_{OS}	Input Offset Current		-30	10	30	pA
			-600		600	pA
e_N	Input Noise Voltage Peak-to-Peak	$f = 0.1\text{Hz}$ to 10Hz		2.8		μV_{P-P}
	Input Noise Voltage Density	$f_O = 1\text{kHz}$		48		$\text{nV}/\sqrt{\text{Hz}}$
i_N	Input Noise Current Density	$f_O = 1\text{kHz}$		0.15		$\text{pA}/\sqrt{\text{Hz}}$
CMIR	Input Voltage Range	Guaranteed by CMRR test	0		5	V
CMRR	Common-Mode Rejection Ratio	$V_{CM} = 0\text{V}$ to 5V	80	100		dB
			75			dB
PSRR	Power Supply Rejection Ratio	$V_S = 2.4\text{V}$ to 5.5V	80	100		dB
			80			dB
A_{VOL}	Large Signal Voltage Gain	$V_O = 0.5\text{V}$ to 4.5V , $R_L = 100\text{k}\Omega$ to $(V_+ + V_-)/2$	100	400		V/mV
			100			VmV

EL8178

Electrical Specifications $V_+ = 5V$, $V_- = 0V$, $V_{CM} = 2.5V$, $V_O = 2.5V$, $T_A = +25^\circ C$ unless otherwise specified. **Boldface limits** apply over the operating temperature range, **-40°C to +125°C. (Continued)**

PARAMETER	DESCRIPTION	TEST CONDITIONS	MIN (Note 3)	TYP	MAX (Note 3)	UNIT
V _{OUT}	Maximum Output Voltage Swing SOT-23/SO-8	V _{OL} ; Output low, R _L = 100kΩ to (V ₊ + V ₋)/2		3	10	mV
		V _{OL} ; Output low, R _L = 1kΩ to (V ₊ + V ₋)/2		130	250	mV
					350	mV
		V _{OH} ; Output high, R _L = 100kΩ to (V ₊ + V ₋)/2	4.994	4.9975		V
V _{OH} ; Output high, R _L = 1kΩ to (V ₊ + V ₋)/2		4.750	4.875		V	
		4.7			V	
SR	Slew Rate		0.10	0.15	0.19	V/μs
			0.07		0.25	V/μs
GBWP	Gain Bandwidth Product	f _O = 100kHz		266		kHz
I _{S(ON)}	Supply Current, Enabled	SOT-23/SO-8	35	55	75	μA
			30		85	μA
I _{S(OFF)}	Supply Current, Disabled			3	5	μA
I _{SC+}	Short Circuit Output Sourcing Current	R _L = 10Ω to opposite supply	23	31		mA
			18			mA
I _{SC-}	Short Circuit Output Sinking Current	R _L = 10Ω to opposite supply	20	26		mA
			15			mA
V _S	Supply Voltage	Guaranteed by PSRR	2.4		5.5	V
			2.4		5.5	V
V _{INH}	\overline{EN} Pin High Level		2			V
V _{INL}	\overline{EN} Pin Low Level				0.8	V
I _{ENH}	\overline{EN} Pin Input Current	V _{EN} = 5V	0.25	0.8	2.5	μA
I _{ENL}	\overline{EN} Pin Input Current	V _{EN} = 0V	-0.5		+0.5	μA

NOTE:

- Parameters with MIN and/or MAX limits are 100% tested at +25°C, unless otherwise specified. Temperature limits established by characterization and are not production tested.

Typical Performance Curves $V_S = \pm 2.5V$, $T_A = +25^\circ C$, Unless Otherwise Specified

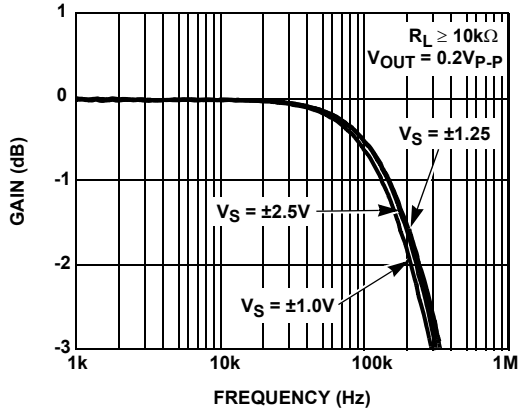

FIGURE 1. UNITY GAIN FREQUENCY RESPONSE at VARIOUS SUPPLY VOLTAGES

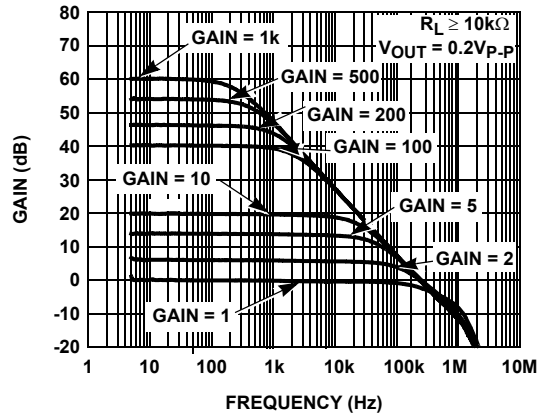

FIGURE 2. FREQUENCY RESPONSE at VARIOUS CLOSED LOOP GAINS

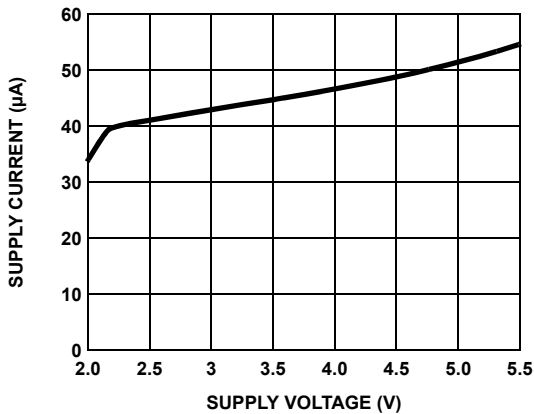

FIGURE 3. SUPPLY CURRENT vs SUPPLY VOLTAGE

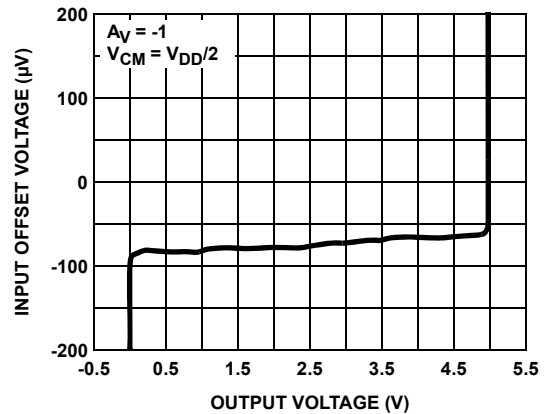

FIGURE 4. INPUT OFFSET VOLTAGE vs OUTPUT VOLTAGE

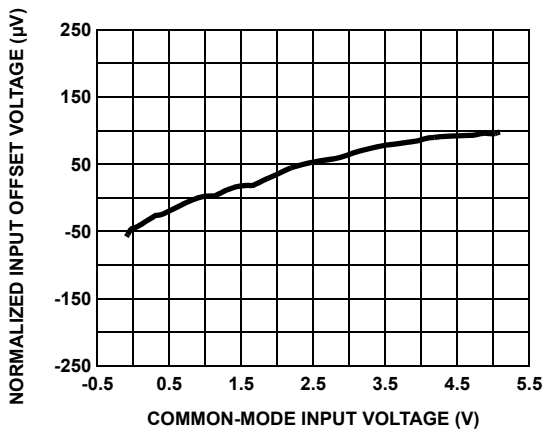

FIGURE 5. INPUT OFFSET VOLTAGE vs COMMON-MODE INPUT VOLTAGE

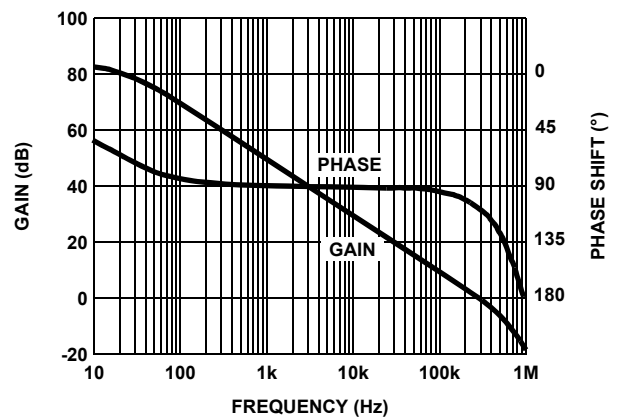

FIGURE 6. OPEN LOOP GAIN AND PHASE vs FREQUENCY ($R_L = 1k\Omega$)

Typical Performance Curves $V_S = \pm 2.5V$, $T_A = +25^\circ C$, Unless Otherwise Specified (Continued)

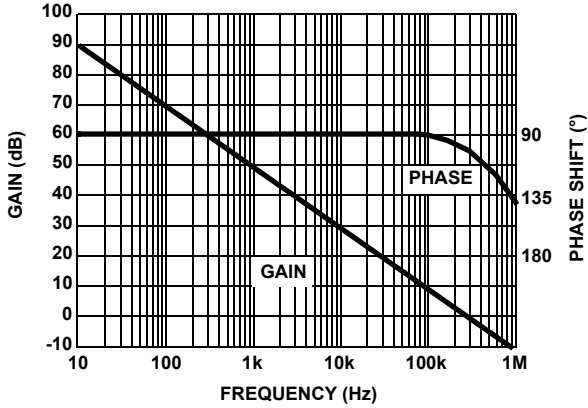

FIGURE 7. OPEN LOOP GAIN AND PHASE vs FREQUENCY ($R_L = 100k\Omega$)

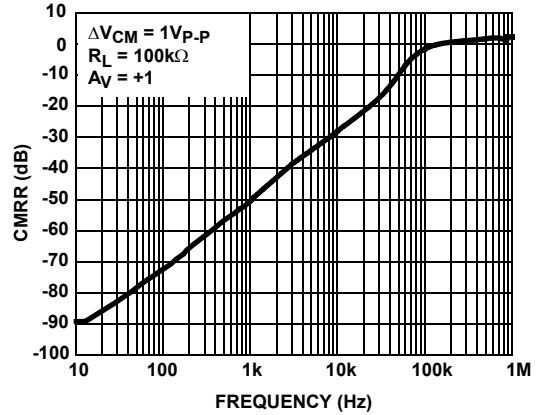

FIGURE 8. CMRR vs FREQUENCY

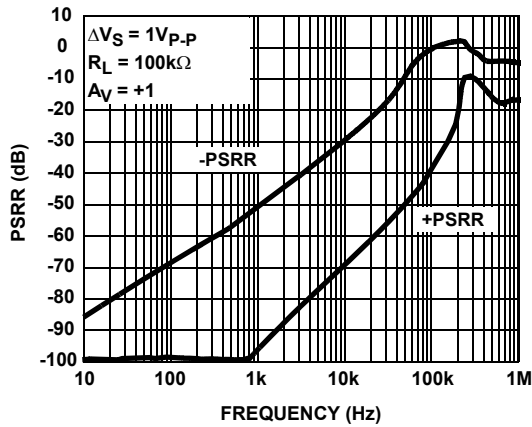

FIGURE 9. PSRR vs FREQUENCY

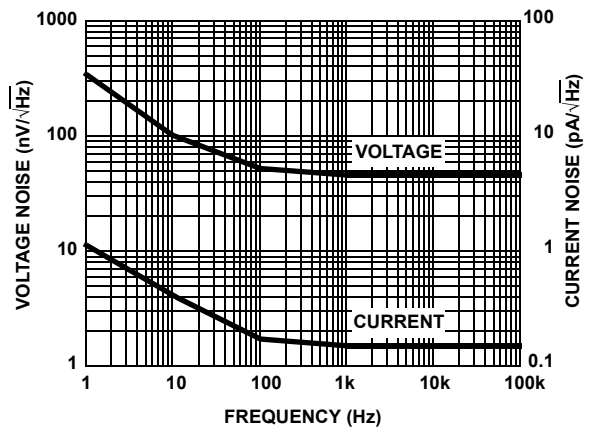

FIGURE 10. INPUT VOLTAGE AND CURRENT NOISE vs FREQUENCY

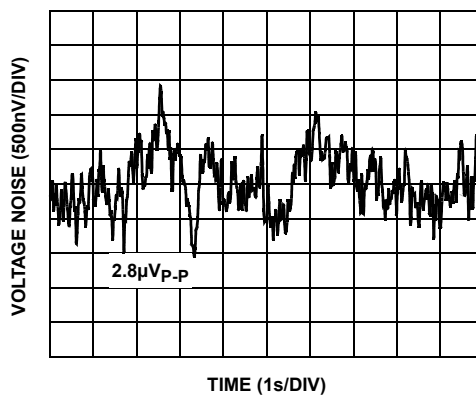

FIGURE 11. 0.1Hz TO 10Hz INPUT VOLTAGE NOISE

Typical Performance Curves $V_S = \pm 2.5V$, $T_A = +25^\circ C$, Unless Otherwise Specified (Continued)

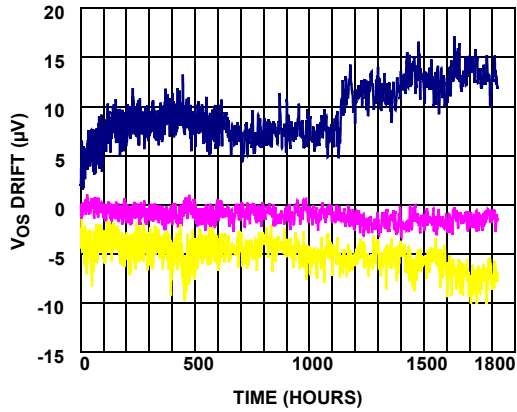

FIGURE 12. VOS DRIFT (SOT-23 PACKAGE) vs TIME

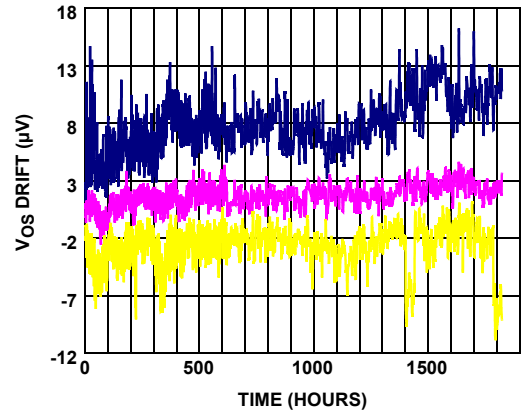

FIGURE 13. VOS DRIFT (SOIC PACKAGE) vs TIME

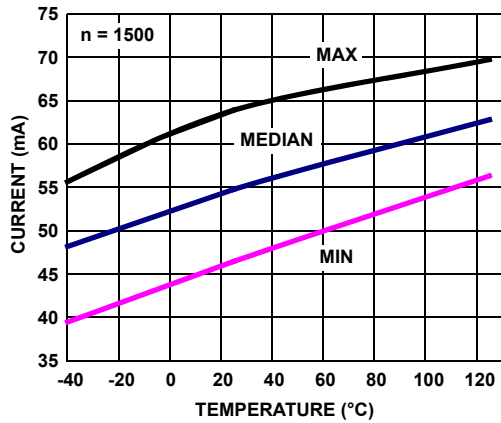

FIGURE 14. ENABLED SUPPLY CURRENT vs TEMPERATURE, $V_S = \pm 2.5V$

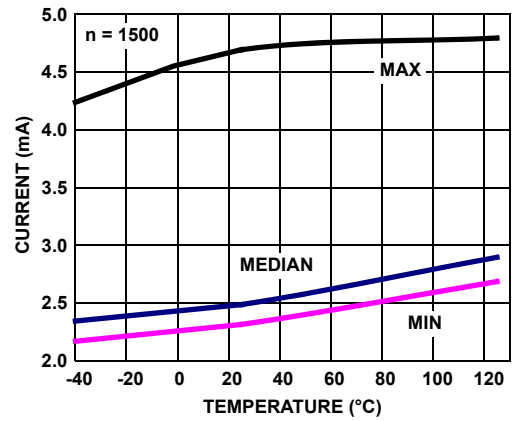

FIGURE 15. DISABLED SUPPLY CURRENT vs TEMPERATURE, $V_S = \pm 2.5V$

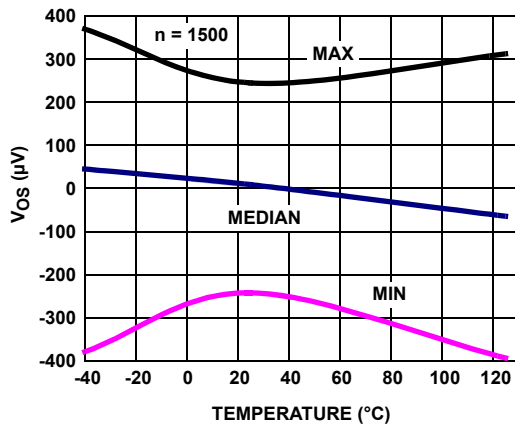

FIGURE 16. V_{OS} vs TEMPERATURE, $V_S = \pm 2.5V$

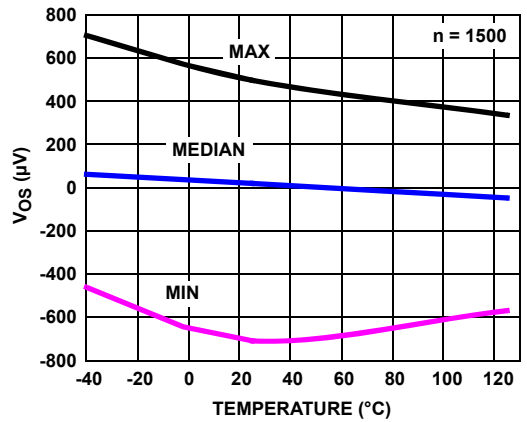

FIGURE 17. V_{OS} vs TEMPERATURE, $V_S = \pm 1.2V$

Typical Performance Curves $V_S = \pm 2.5V$, $T_A = +25^\circ C$, Unless Otherwise Specified (Continued)

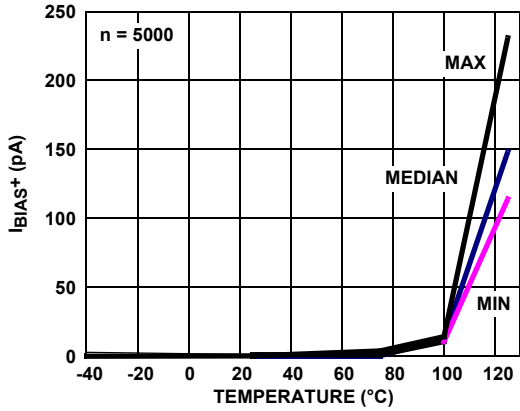

FIGURE 18. I_{BIAS+} vs TEMPERATURE, $V_S = \pm 2.5V$

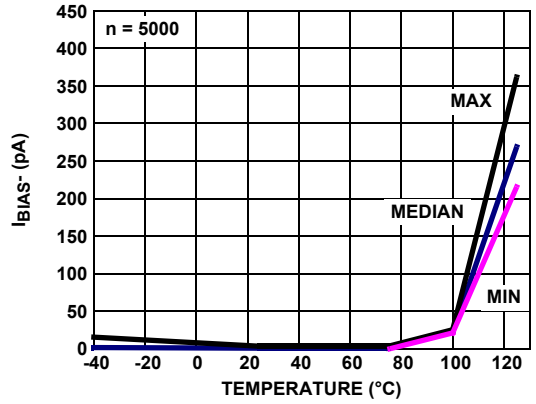

FIGURE 19. I_{BIAS-} vs TEMPERATURE, $V_S = \pm 2.5V$

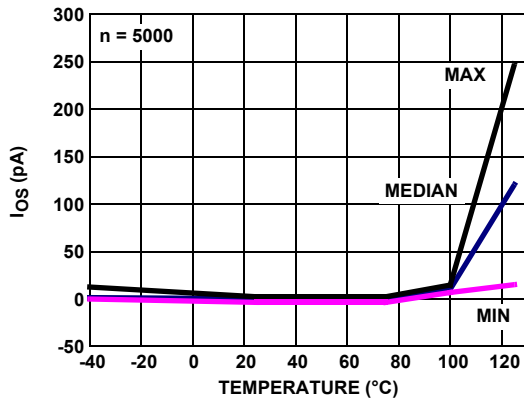

FIGURE 20. I_{OS} vs TEMPERATURE, $V_S = \pm 2.5V$

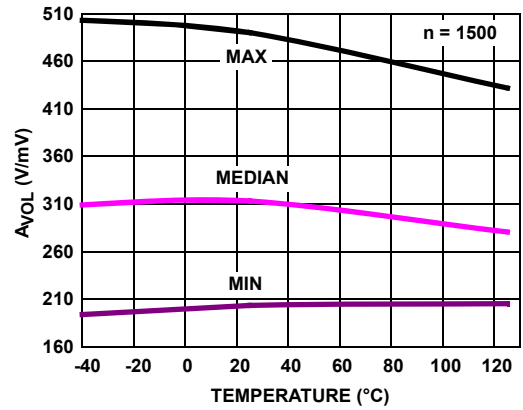

FIGURE 21. A_{VOL} vs TEMPERATURE, $R_L = 100k$, $V_O = \pm 2V$ @ $V_S = \pm 2.5V$

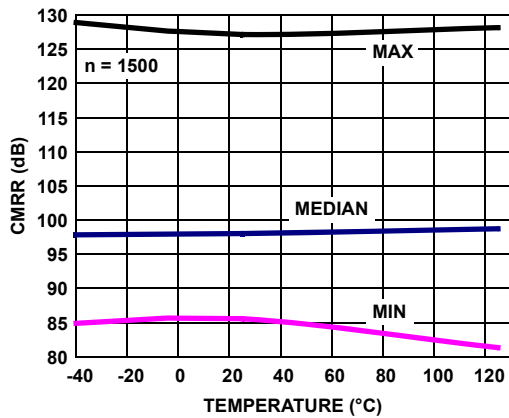

FIGURE 22. CMRR vs TEMPERATURE, $V+ = \pm 2.5V$, $\pm 1.5V$

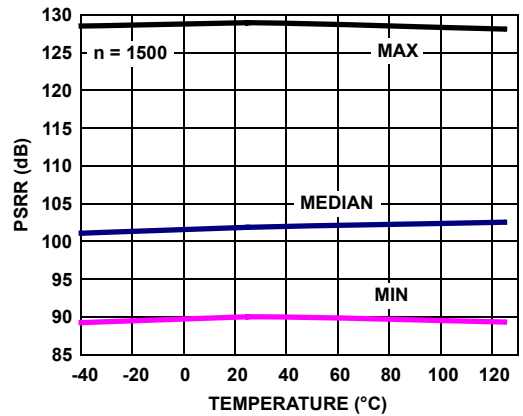

FIGURE 23. PSRR vs TEMPERATURE $\pm 1.5V$ TO $\pm 2.5V$

Typical Performance Curves $V_S = \pm 2.5V$, $T_A = +25^\circ C$, Unless Otherwise Specified (Continued)

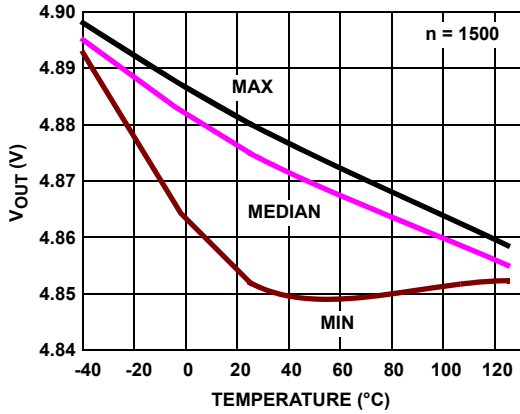

FIGURE 24. V_{OUT} HIGH vs TEMPERATURE, $V_S = \pm 2.5V$, $R_L = 1k$

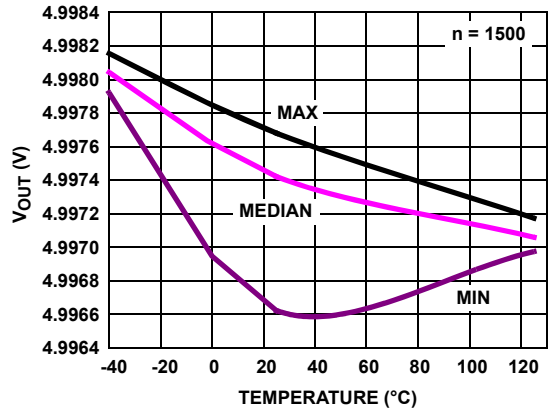

FIGURE 25. V_{OUT} HIGH vs TEMPERATURE, $V_S = \pm 2.5V$, $R_L = 100k$

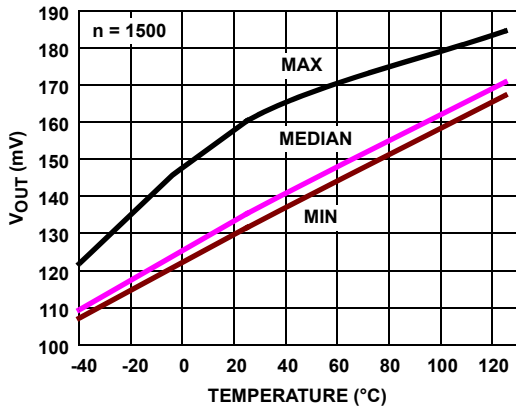

FIGURE 26. V_{OUT} LOW vs TEMPERATURE, $V_S = \pm 2.5V$, $R_L = 1k$

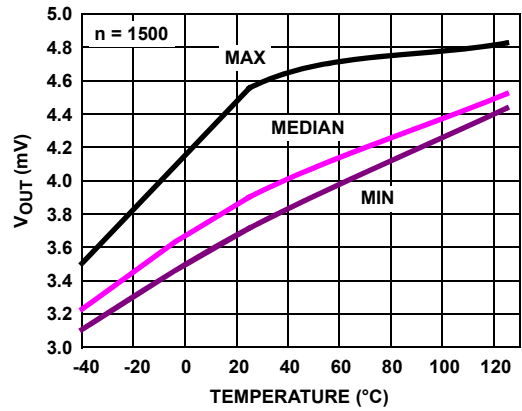
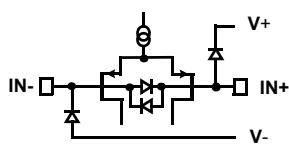

FIGURE 27. V_{OUT} LOW vs TEMPERATURE, $V_S = \pm 2.5V$, $R_L = 100k$

Pin Descriptions

SO PIN NUMBER	SOT-23 PIN NUMBER	PIN NAME	EQUIVALENT CIRCUIT	DESCRIPTION
1		NC		No internal connection
2	4	IN-	Circuit 1	Amplifier's inverting input
3	3	IN+	Circuit 1	Amplifier's non-inverting input
4	2	V-	Circuit 4	Negative power supply
5		NC		No internal connection
6	1	OUT	Circuit 3	Amplifier's output
7	6	V+	Circuit 4	Positive power supply
8	5	$\overline{\text{EN}}$	Circuit 2	Amplifier's enable pin with internal pull-down; Logic "1" selects the disabled state; Logic "0" selects the enabled state.



CIRCUIT 1

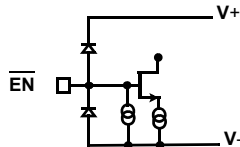

CIRCUIT 2

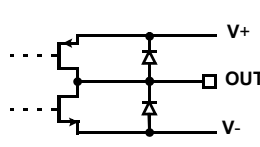

CIRCUIT 3

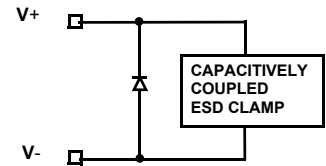

CIRCUIT 4

Application Information

Introduction

The EL8178 is a rail-to-rail input and output (RRIO), micropower, precision, single supply op amp with an enable feature. This amplifier is designed to operate from single supply (2.4V to 5.5V) or dual supply ($\pm 1.2V$ to $\pm 2.75V$) while drawing only 55 μA of supply current. The device achieves rail-to-rail input and output operation while eliminating the drawbacks of many conventional RRIO op amps.

Rail-to-Rail Input

The PFET input stage of the EL8178 has an input common-mode voltage range that includes the negative and positive supplies without introducing offset errors or degrading performance like some existing rail-to-rail input op amps. Many rail-to-rail input stages use two differential input pairs: a long-tail PNP (or PFET) and an NPN (or NFET). Severe penalties result from using this topology. As the input signal moves from one supply rail to the other, the op amp switches from one input pair to the other causing changes in input offset voltage and an undesired change in the input offset current's magnitude and polarity.

The EL8178 achieves rail-to-rail input performance without sacrificing important precision specifications and without degrading distortion performance. The EL8178's input offset voltage exhibits a smooth behavior throughout the entire common-mode input range.

Rail-to-Rail Output

A pair of complementary MOSFET devices achieve rail-to-rail output swing. The NMOS sinks current to swing the output in the negative direction, while the PMOS sources current to swing the output in the positive direction. The EL8178 with a 100k Ω load swings to within 3mV of the supply rails.

Results of Overdriving the Output

Caution should be used when overdriving the output for long periods of time. Overdriving the output can occur in three ways:

1. The input voltage times the gain of the amplifier exceeds the supply voltage by a large value.
2. The output current required is higher than the output stage can deliver.
3. Operating the device in slew rate limit. These conditions can result in a shift in the Input Offset Voltage (V_{OS}) as much as 1 $\mu V/hr$ of exposure under these conditions.

Enable/Disable Feature

The EL8178 features an active low $\overline{\text{EN}}$ pin that when pulled up to at least 2V, disables the output and drops the I_{CC} to a 3 μA . The $\overline{\text{EN}}$ pin has an internal pull-down, so an undriven pin pulls to the negative rail, thereby enabling the op amp by default. For applications where the $\overline{\text{EN}}$ pin is not being used, it is recommended that the $\overline{\text{EN}}$ pin be permanently tied to ground.

The high impedance output during disable allows for connecting multiple EL8178s together to implement a Mux Amp. The outputs are connected together and activating the appropriate $\overline{\text{EN}}$ pin selects the desired channel. If utilizing non-unity gain op amp configurations, then the loading

effects of the disabled amplifiers' feedback networks must be considered when evaluating the active amplifier's performance in Mux Amp configurations.

Note that feed through from the IN+ to IN- pins occurs on any Mux Amp disabled channel where the input differential voltage exceeds 0.5V (e.g., active channel $V_{OUT} = 1V$, while disabled channel $V_{IN} = GND$), so the mux implementation is best suited for small signal applications. In any application where two or more amplifier outputs are muxed, use series IN+ resistors, or large value R_F s in each amplifier to keep the feed through current low enough to minimize the impact on the active channel. See "Usage Implications" on page 10 for more details.

IN+ and IN- Input Protection

In addition to ESD protection diodes to each supply rail, the EL8178 has additional back-to-back protection diodes across the differential input terminals. If the magnitude of the differential input voltage exceeds the diode's V_F , then one of these diodes will conduct. For elevated temperatures, the leakage of the protection diodes (see Circuit 1 in "Pin Descriptions" on page 9) increases, resulting in the increase in I_{BIAS} , as seen in Figures 18 and 19.

USAGE IMPLICATIONS

If the input differential voltage is expected to exceed 0.5V, an external current limiting resistor must be used to ensure the input current never exceeds 5mA. For noninverting unity gain applications, the current limiting can be via a series IN+ resistor, or via a feedback resistor of appropriate value. For other gain configurations, the series IN+ resistor is the best choice, unless the feedback (R_F) and gain setting (R_G) resistors are both sufficiently large to limit the input current to 5mA.

Large differential input voltages can arise from several sources:

1. During open loop (comparator) operation. The IN+ and IN- input voltages don't track.
2. When the amplifier is disabled but an input signal is still present. An R_L or R_G to GND keeps the IN- at GND, while the varying IN+ signal creates a differential voltage. Mux Amp applications are similar, except that the active channel V_{OUT} determines the voltage on the IN- terminal.
3. When the slew rate of the input pulse is considerably faster than the op amp's slew rate. If the V_{OUT} can't keep up with the IN+ signal, a differential voltage results, and visible distortion occurs on the input and output signals. To avoid this issue, keep the input slew rate below 0.2V/ μ s, or use appropriate current limiting resistors.

Large (>2V) differential input voltages can also cause an increase in disabled I_{CC} .

EN Input Protection

The EN input has internal ESD protection diodes to both the positive and negative supply rails, limiting the input voltage range to within one diode beyond the supply rails (see "Circuit 2" diagram on page 9). If the input voltage is expected to exceed $V+$ or $V-$, then an external series resistor should be added to limit the current to 5mA.

Output Current Limiting

The EL8178 has no internal current-limiting circuitry. If the output is shorted, it is possible to exceed the "Absolute Maximum Rating" for "operating junction temperature", potentially resulting in the destruction of the device.

Power Dissipation

It is possible to exceed the +150°C maximum junction temperature (T_{JMAX}) under certain load and power-supply conditions. It is therefore important to calculate T_{JMAX} for all applications to determine if power supply voltages, load conditions, or package type need to be modified to remain in the safe operating area. These parameters are related in Equation 1:

$$T_{JMAX} = T_{MAX} + (\theta_{JA} \times PD_{MAX}) \tag{EQ. 1}$$

where PD_{MAX} is calculated using Equation 2:

$$PD_{MAX} = V_S \times I_{SMAX} + (V_S - V_{OUTMAX}) \times \frac{V_{OUTMAX}}{R_L} \tag{EQ. 2}$$

where:

- T_{MAX} = Maximum ambient temperature
- θ_{JA} = Thermal resistance of the package
- PD_{MAX} = Maximum power dissipation of the amplifier
- V_S = Supply voltage
- I_{MAX} = Maximum supply current of the amplifier
- V_{OUTMAX} = Maximum output voltage swing of the application
- R_L = Load resistance

Proper Layout Maximizes Precision

To achieve the optimum levels of high input impedance (i.e., low input currents) and low offset voltage, care should be taken in the circuit board layout. The PC board surface must remain clean and free of moisture to avoid leakage currents between adjacent traces. Surface coating of the circuit board will reduce surface moisture and provide a humidity barrier, reducing parasitic resistance on the board. When input leakage current is a paramount concern, the use of guard rings around the amplifier inputs will further reduce leakage currents. Figure 28 shows a guard ring example for a unity gain amplifier that uses the low impedance amplifier output at the same voltage as the high impedance input to eliminate surface leakage. The guard ring does not need to be a specific width, but it should form a continuous loop around both inputs. For further reduction of leakage currents, mount components to the PC board using Teflon standoffs..

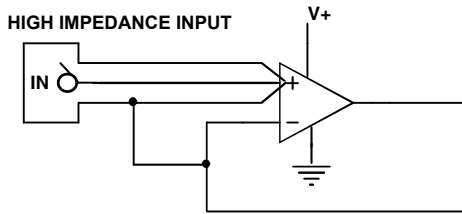

FIGURE 28. GUARD RING EXAMPLE FOR UNITY GAIN AMPLIFIER

Typical Applications

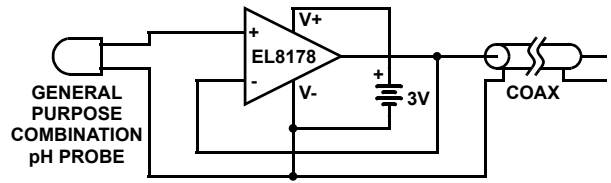

FIGURE 29. pH PROBE AMPLIFIER

A general-purpose combination pH probe has extremely high output impedance typically in the range of 10GΩ to 12GΩ. Low loss and expensive Teflon cables are often used to connect the pH probe to the meter electronics. Figure 29 details a low-cost alternative solution using the EL8178 and a low-cost coax cable. The EL8178 PMOS high impedance input senses the pH probe output signal and buffers it to drive the coax cable. Its rail-to-rail input nature also eliminates the need for a bias resistor network required by other amplifiers in the same application.

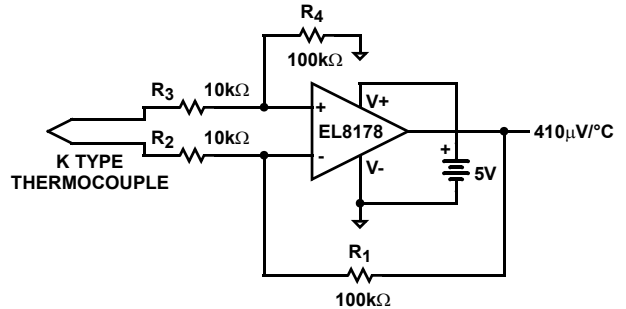
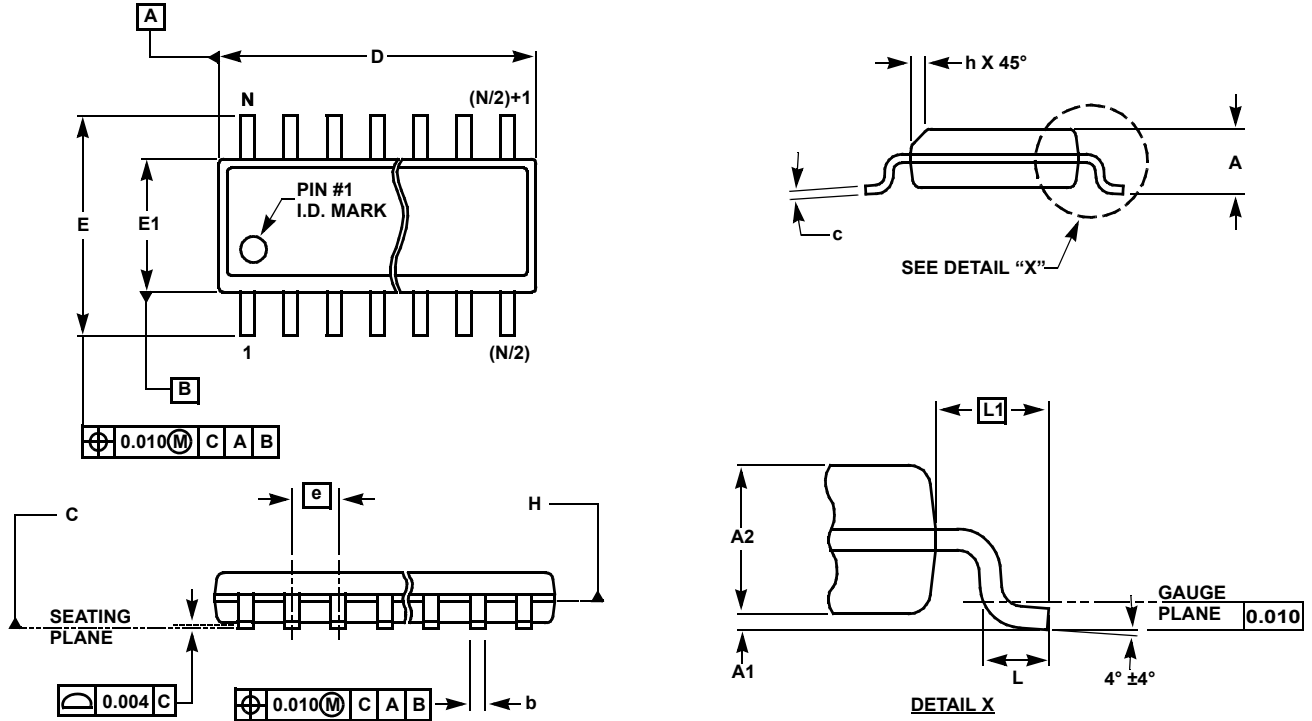

FIGURE 30. THERMOCOUPLE AMPLIFIER

Thermocouples are the most popular temperature sensing devices because of their low cost, interchangeability, and ability to measure a wide range of temperatures. In Figure 30, the EL8178 converts the differential thermocouple voltage into single-ended signal with 10x gain. The EL8178's rail-to-rail input characteristic allows the thermocouple to be biased at ground and permits the op amp to operate from a single 5V supply.

Small Outline Package Family (SO)



MDP0027

SMALL OUTLINE PACKAGE FAMILY (SO)

SYMBOL	INCHES							TOLERANCE	NOTES
	SO-8	SO-14	SO16 (0.150")	SO16 (0.300") (SOL-16)	SO20 (SOL-20)	SO24 (SOL-24)	SO28 (SOL-28)		
A	0.068	0.068	0.068	0.104	0.104	0.104	0.104	MAX	-
A1	0.006	0.006	0.006	0.007	0.007	0.007	0.007	± 0.003	-
A2	0.057	0.057	0.057	0.092	0.092	0.092	0.092	± 0.002	-
b	0.017	0.017	0.017	0.017	0.017	0.017	0.017	± 0.003	-
c	0.009	0.009	0.009	0.011	0.011	0.011	0.011	± 0.001	-
D	0.193	0.341	0.390	0.406	0.504	0.606	0.704	± 0.004	1, 3
E	0.236	0.236	0.236	0.406	0.406	0.406	0.406	± 0.008	-
E1	0.154	0.154	0.154	0.295	0.295	0.295	0.295	± 0.004	2, 3
e	0.050	0.050	0.050	0.050	0.050	0.050	0.050	Basic	-
L	0.025	0.025	0.025	0.030	0.030	0.030	0.030	± 0.009	-
L1	0.041	0.041	0.041	0.056	0.056	0.056	0.056	Basic	-
h	0.013	0.013	0.013	0.020	0.020	0.020	0.020	Reference	-
N	8	14	16	16	20	24	28	Reference	-

Rev. M 2/07

NOTES:

1. Plastic or metal protrusions of 0.006" maximum per side are not included.
2. Plastic interlead protrusions of 0.010" maximum per side are not included.
3. Dimensions "D" and "E1" are measured at Datum Plane "H".
4. Dimensioning and tolerancing per ASME Y14.5M-1994

SOT-23 Package Family

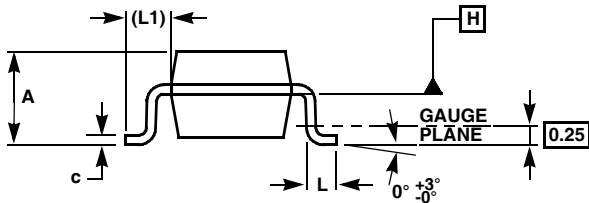
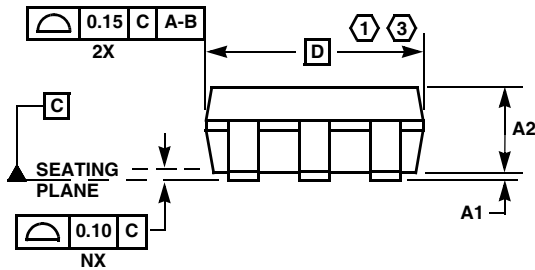
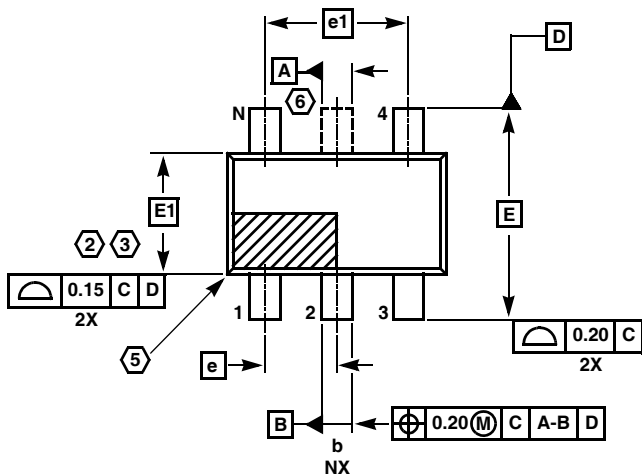

MDP0038

SOT-23 PACKAGE FAMILY

SYMBOL	MILLIMETERS		TOLERANCE
	SOT23-5	SOT23-6	
A	1.45	1.45	MAX
A1	0.10	0.10	±0.05
A2	1.14	1.14	±0.15
b	0.40	0.40	±0.05
c	0.14	0.14	±0.06
D	2.90	2.90	Basic
E	2.80	2.80	Basic
E1	1.60	1.60	Basic
e	0.95	0.95	Basic
e1	1.90	1.90	Basic
L	0.45	0.45	±0.10
L1	0.60	0.60	Reference
N	5	6	Reference

Rev. F 2/07

NOTES:

1. Plastic or metal protrusions of 0.25mm maximum per side are not included.
2. Plastic interlead protrusions of 0.25mm maximum per side are not included.
3. This dimension is measured at Datum Plane "H".
4. Dimensioning and tolerancing per ASME Y14.5M-1994.
5. Index area - Pin #1 I.D. will be located within the indicated zone (SOT23-6 only).
6. SOT23-5 version has no center lead (shown as a dashed line).

All Intersil U.S. products are manufactured, assembled and tested utilizing ISO9000 quality systems. Intersil Corporation's quality certifications can be viewed at www.intersil.com/design/quality

Intersil products are sold by description only. Intersil Corporation reserves the right to make changes in circuit design, software and/or specifications at any time without notice. Accordingly, the reader is cautioned to verify that data sheets are current before placing orders. Information furnished by Intersil is believed to be accurate and reliable. However, no responsibility is assumed by Intersil or its subsidiaries for its use; nor for any infringements of patents or other rights of third parties which may result from its use. No license is granted by implication or otherwise under any patent or patent rights of Intersil or its subsidiaries.

For information regarding Intersil Corporation and its products, see www.intersil.com