

LOW DROP FIXED AND ADJUSTABLE POSITIVE VOLTAGE REGULATOR

The KIA78Q × × ×PI is a Low Drop Voltage Regulator able to provide up to 0.8A of output current, available even in adjustable version (Vref=1.25V)

FEATURES

- Low Dropout Voltage : 1.1V/Typ. (Iout=0.8A)
- Very Low Quiescent Current : 4.2mA/Typ.
- Output Current up to 0.8A
- Fixed Output Voltage of 1.5V, 1.8V, 2.5V, 2.85V, 3.3V, 5.0V
- Adjustable Version Availability : Vref=1.25V
- Internal Current and Thermal Limit
- Only 10 μF for stability
- Available in ±2% (at 25 °C) and 4% in full Temperature range
- High Ripple Rejection : 80dB/Typ.
- Temperature Range : 0 °C ~ 125 °C

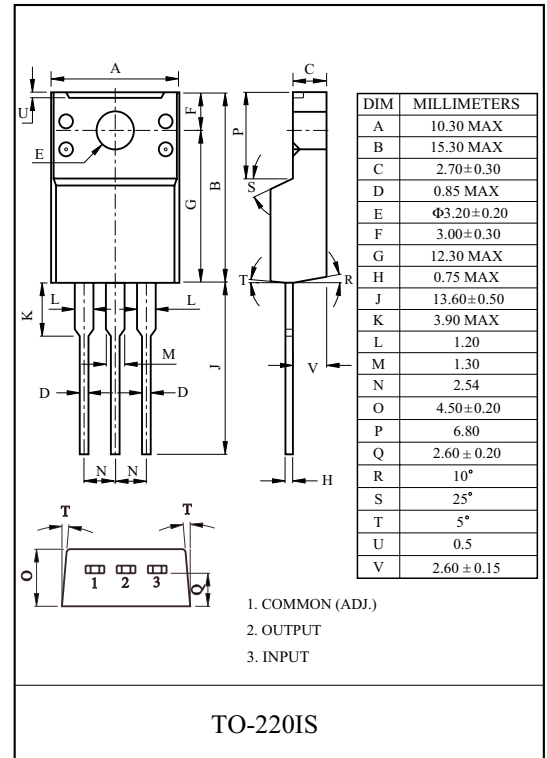

LINE UP

ITEM	OUTPUT VOLTAGE (V)	PACKAGE
KIA78Q000PI	Adjustable (1.25~10V)	TO-220IS
KIA78Q015PI	1.5	
KIA78Q018PI	1.8	
KIA78Q025PI	2.5	
KIA78Q028PI	2.85	
KIA78Q033PI	3.3	
KIA78Q050PI	5.0	

MAXIMUM RATINGS (Ta=25 °C)

CHARACTERISTIC	SYMBOL	RATING	UNIT
Input Voltage	V _{IN}	10	V
Output Current	I _{OUT}	0.8	A
Power Dissipation 1 (No heatsink)	P _{D1}	2.0	W
Power Dissipation 2 (Without heatsink)	P _{D2}	20.8	W
Operating Temperature	T _{opr}	0 ~ 125	°C
Storage Temperature	T _{stg}	-55 ~ 150	°C

KIA78Q000PI~KIA78Q050PI

Fig.1 Application Circuit-1 (Fixed-Type)

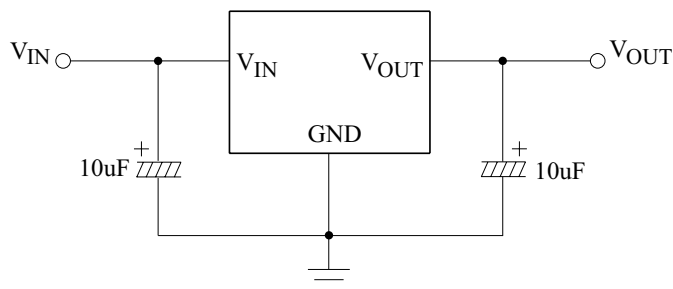
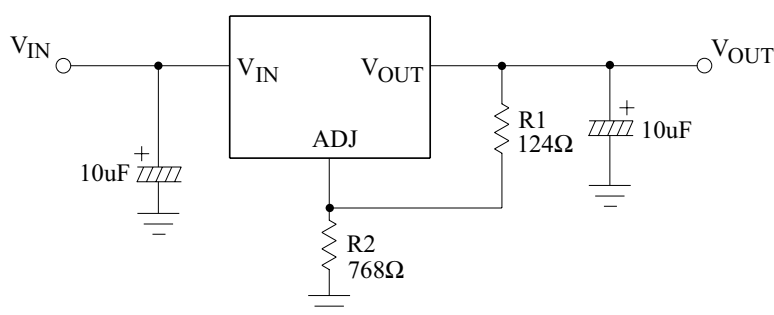

Fig.2 Application Circuit-2 (Adjustable-Type)



$$V_{OUT} = V_{REF} (1 + R2/R1) + I_{ADJ} \cdot R2$$

ELECTRICAL CHARACTERISTICS

KIA78Q000PI (Unless otherwise specified, $T_j = 0 \sim 125^\circ\text{C}$)

CHARACTERISTIC	SYMBOL	TEST CONDITIONS	MIN.	TYP.	MAX.	UNIT
Output Voltage	V_{OUT1}	$V_{IN} = V_{OUT} + 1.5\text{V}$, $I_{OUT} = 10\text{mA}$, $T_j = 25^\circ\text{C}$	1.225	1.25	1.275	V
	V_{OUT2}	$10\text{mA} \leq I_{OUT} \leq 0.8\text{A}$, $V_{OUT} + 1.5\text{V} \leq V_{IN} \leq 10\text{V}$	1.20	1.25	1.30	
Line Regulation	Reg Line	$V_{OUT} + 1.5\text{V} \leq V_{IN} \leq 10\text{V}$, $I_{OUT} = 10\text{mA}$	-	1	10	mV
Load Regulation	Reg Load	$10\text{mA} \leq I_{OUT} \leq 0.8\text{A}$, $V_{IN} = V_{OUT} + 2.0\text{V}$	-	15	30	mV
Quiescent Current	I_{B1}	$V_{IN} = V_{OUT} + 1.25\text{V}$, $I_{OUT} = 0\text{A}$	-	4.2	10	mA
	I_{B2}	$V_{IN} = 10\text{V}$, $I_{OUT} = 0\text{A}$	-	4.2	10	
Adjustable Pin Current	I_{ADJ}	$V_{IN} = V_{OUT} + 1.5\text{V}$	-	35	-	μA
Minimum Load Current	I_{MIN}	$V_{IN} = V_{OUT} + 1.5\text{V}$	10	-	-	mA
Output Noise Voltage	V_{NO}	$V_{IN} = V_{OUT} + 1.25\text{V}$, $I_{OUT} = 40\text{mA}$, $10\text{Hz} \leq f \leq 10\text{kHz}$	-	100	-	μV_{rms}
Sort Circuit Current Limit	I_{SC}	$V_{IN} = V_{OUT} + 2.0\text{V}$	1.1	-	-	A
Ripple Rejection	$R \cdot R$	$I_{OUT} = 40\text{mA}$, $f = 120\text{Hz}$, $V_{ripple} = 1\text{V}_{p-p}$ $V_{IN} = V_{OUT} + 3\text{V}$	60	80	-	dB
Dropout Voltage	V_D	$I_{OUT} = 0.8\text{A}$, $V_{IN} = 0.95V_{OUT}$	-	1.1	1.2	V
Temperature Stability	TCV_O	$V_{IN} = V_{OUT} + 1.5\text{V}$, $I_{OUT} = 10\text{mA}$	-	0.5	-	%

KIA78Q000PI~KIA78Q050PI

ELECTRICAL CHARACTERISTICS

KIA78Q015PI (Unless otherwise specified, Tj=0~125 °C)

CHARACTERISTIC	SYMBOL	TEST CONDITIONS	MIN.	TYP.	MAX.	UNIT
Output Voltage	V _{OUT1}	V _{IN} =V _{OUT} +1.5V, I _{OUT} =10mA, Tj=25 °C	1.47	1.5	1.53	V
	V _{OUT2}	10mA ≤ I _{OUT} ≤ 0.8A, V _{OUT} +1.5V ≤ V _{IN} ≤ 10V	1.44	1.5	1.56	
Line Regulation	Reg Line	V _{OUT} +1.5V ≤ V _{IN} ≤ 10V, I _{OUT} =10mA	-	1	10	mV
Load Regulation	Reg Load	10mA ≤ I _{OUT} ≤ 0.8A, V _{IN} =V _{OUT} +2.0V	-	15	30	mV
Quiescent Current	I _{B1}	V _{IN} =V _{OUT} +1.25V, I _{OUT} =0A	-	4.2	10	mA
	I _{B2}	V _{IN} =10V, I _{OUT} =0A	-	4.2	10	
Output Noise Voltage	V _{NO}	V _{IN} =V _{OUT} +1.25V, I _{OUT} =40mA, 10Hz ≤ f ≤ 10kHz	-	100	-	μVrms
Sort Circuit Current Limit	I _{SC}	V _{IN} =V _{OUT} +2.0V	1.1	-	-	A
Ripple Rejection	R · R	I _{OUT} =40mA, f=120Hz, V _{ripple} =1Vp-p V _{IN} =V _{OUT} +3V	60	80	-	dB
Dropout Voltage	V _D	I _{OUT} =0.8A, V _{IN} =0.95V _{OUT}	-	1.1	1.2	V
Temperature Stability	TCV _O	V _{IN} =V _{OUT} +1.5V, I _{OUT} =10mA	-	0.5	-	%

ELECTRICAL CHARACTERISTICS

KIA78Q018PI (Unless otherwise specified, Tj=0~125 °C)

CHARACTERISTIC	SYMBOL	TEST CONDITIONS	MIN.	TYP.	MAX.	UNIT
Output Voltage	V _{OUT1}	V _{IN} =V _{OUT} +1.5V, I _{OUT} =10mA, Tj=25 °C	1.764	1.8	1.836	V
	V _{OUT2}	10mA ≤ I _{OUT} ≤ 0.8A, V _{OUT} +1.5V ≤ V _{IN} ≤ 10V	1.728	1.8	1.872	
Line Regulation	Reg Line	V _{OUT} +1.5V ≤ V _{IN} ≤ 10V, I _{OUT} =10mA	-	1	10	mV
Load Regulation	Reg Load	10mA ≤ I _{OUT} ≤ 0.8A, V _{IN} =V _{OUT} +2.0V	-	15	30	mV
Quiescent Current	I _{B1}	V _{IN} =V _{OUT} +1.25V, I _{OUT} =0A	-	4.2	10	mA
	I _{B2}	V _{IN} =10V, I _{OUT} =0A	-	4.2	10	
Output Noise Voltage	V _{NO}	V _{IN} =V _{OUT} +1.25V, I _{OUT} =40mA, 10Hz ≤ f ≤ 10kHz	-	100	-	μVrms
Sort Circuit Current Limit	I _{SC}	V _{IN} =V _{OUT} +2.0V	1.1	-	-	A
Ripple Rejection	R · R	I _{OUT} =40mA, f=120Hz, V _{ripple} =1Vp-p V _{IN} =V _{OUT} +3V	60	80	-	dB
Dropout Voltage	V _D	I _{OUT} =0.8A, V _{IN} =0.95V _{OUT}	-	1.1	1.2	V
Temperature Stability	TCV _O	V _{IN} =V _{OUT} +1.5V, I _{OUT} =10mA	-	0.5	-	%

KIA78Q000PI~KIA78Q050PI

ELECTRICAL CHARACTERISTICS

KIA78Q025PI (Unless otherwise specified, Tj=0~125 °C)

CHARACTERISTIC	SYMBOL	TEST CONDITIONS	MIN.	TYP.	MAX.	UNIT
Output Voltage	V _{OUT1}	V _{IN} =V _{OUT} +1.5V, I _{OUT} =10mA, Tj=25 °C	2.45	2.5	2.55	V
	V _{OUT2}	10mA ≤ I _{OUT} ≤ 0.8A, V _{OUT} +1.5V ≤ V _{IN} ≤ 10V	2.4	2.5	2.6	
Line Regulation	Reg Line	V _{OUT} +1.5V ≤ V _{IN} ≤ 10V, I _{OUT} =10mA	-	1	10	mV
Load Regulation	Reg Load	10mA ≤ I _{OUT} ≤ 0.8A, V _{IN} =V _{OUT} +2.0V	-	15	30	mV
Quiescent Current	I _{B1}	V _{IN} =V _{OUT} +1.25V, I _{OUT} =0A	-	4.2	10	mA
	I _{B2}	V _{IN} =10V, I _{OUT} =0A	-	4.2	10	
Output Noise Voltage	V _{NO}	V _{IN} =V _{OUT} +1.25V, I _{OUT} =40mA, 10Hz ≤ f ≤ 10kHz	-	100	-	μVrms
Sort Circuit Current Limit	I _{SC}	V _{IN} =V _{OUT} +2.0V	1.1	-	-	A
Ripple Rejection	R · R	I _{OUT} =40mA, f=120Hz, V _{ripple} =1Vp-p V _{IN} =V _{OUT} +3V	60	80	-	dB
Dropout Voltage	V _D	I _{OUT} =0.8A, V _{IN} =0.95V _{OUT}	-	1.1	1.2	V
Temperature Stability	TCV _O	V _{IN} =V _{OUT} +1.5V, I _{OUT} =10mA	-	0.5	-	%

ELECTRICAL CHARACTERISTICS

KIA78Q028PI (Unless otherwise specified, Tj=0~125 °C)

CHARACTERISTIC	SYMBOL	TEST CONDITIONS	MIN.	TYP.	MAX.	UNIT
Output Voltage	V _{OUT1}	V _{IN} =V _{OUT} +1.5V, I _{OUT} =10mA, Tj=25 °C	2.793	2.85	2.907	V
	V _{OUT2}	10mA ≤ I _{OUT} ≤ 0.8A, V _{OUT} +1.5V ≤ V _{IN} ≤ 10V	2.736	2.85	2.964	
Line Regulation	Reg Line	V _{OUT} +1.5V ≤ V _{IN} ≤ 10V, I _{OUT} =10mA	-	1	10	mV
Load Regulation	Reg Load	10mA ≤ I _{OUT} ≤ 0.8A, V _{IN} =V _{OUT} +2.0V	-	15	30	mV
Quiescent Current	I _{B1}	V _{IN} =V _{OUT} +1.25V, I _{OUT} =0A	-	4.2	10	mA
	I _{B2}	V _{IN} =10V, I _{OUT} =0A	-	4.2	10	
Output Noise Voltage	V _{NO}	V _{IN} =V _{OUT} +1.25V, I _{OUT} =40mA, 10Hz ≤ f ≤ 10kHz	-	100	-	μVrms
Sort Circuit Current Limit	I _{SC}	V _{IN} =V _{OUT} +2.0V	1.1	-	-	A
Ripple Rejection	R · R	I _{OUT} =40mA, f=120Hz, V _{ripple} =1Vp-p V _{IN} =V _{OUT} +3V	60	80	-	dB
Dropout Voltage	V _D	I _{OUT} =0.8A, V _{IN} =0.95V _{OUT}	-	1.1	1.2	V
Temperature Stability	TCV _O	V _{IN} =V _{OUT} +1.5V, I _{OUT} =10mA	-	0.5	-	%

KIA78Q000PI~KIA78Q050PI

ELECTRICAL CHARACTERISTICS

KIA78Q033PI (Unless otherwise specified, Tj=0~125 °C)

CHARACTERISTIC	SYMBOL	TEST CONDITIONS	MIN.	TYP.	MAX.	UNIT
Output Voltage	V _{OUT1}	V _{IN} =V _{OUT} +1.5V, I _{OUT} =10mA, Tj=25 °C	3.234	3.3	3.366	V
	V _{OUT2}	10mA ≤ I _{OUT} ≤ 0.8A, V _{OUT} +1.5V ≤ V _{IN} ≤ 10V	3.168	3.3	3.432	
Line Regulation	Reg Line	V _{OUT} +1.5V ≤ V _{IN} ≤ 10V, I _{OUT} =10mA	-	1	10	mV
Load Regulation	Reg Load	10mA ≤ I _{OUT} ≤ 0.8A, V _{IN} =V _{OUT} +2.0V	-	15	30	mV
Quiescent Current	I _{B1}	V _{IN} =V _{OUT} +1.25V, I _{OUT} =0A	-	4.2	10	mA
	I _{B2}	V _{IN} =10V, I _{OUT} =0A	-	4.2	10	
Output Noise Voltage	V _{NO}	V _{IN} =V _{OUT} +1.25V, I _{OUT} =40mA, 10Hz ≤ f ≤ 10kHz	-	100	-	μVrms
Sort Circuit Current Limit	I _{SC}	V _{IN} =V _{OUT} +2.0V	1.1	-	-	A
Ripple Rejection	R · R	I _{OUT} =40mA, f=120Hz, V _{ripple} =1Vp-p V _{IN} =V _{OUT} +3V	60	80	-	dB
Dropout Voltage	V _D	I _{OUT} =0.8A, V _{IN} =0.95V _{OUT}	-	1.1	1.2	V
Temperature Stability	TCV _O	V _{IN} =V _{OUT} +1.5V, I _{OUT} =10mA	-	0.5	-	%

ELECTRICAL CHARACTERISTICS

KIA78Q050PI (Unless otherwise specified, Tj=0~125 °C)

CHARACTERISTIC	SYMBOL	TEST CONDITIONS	MIN.	TYP.	MAX.	UNIT
Output Voltage	V _{OUT1}	V _{IN} =V _{OUT} +1.5V, I _{OUT} =10mA, Tj=25 °C	4.9	5	5.1	V
	V _{OUT2}	10mA ≤ I _{OUT} ≤ 0.8A, V _{OUT} +1.5V ≤ V _{IN} ≤ 10V	4.8	5	5.2	
Line Regulation	Reg Line	V _{OUT} +1.5V ≤ V _{IN} ≤ 10V, I _{OUT} =10mA	-	1	10	mV
Load Regulation	Reg Load	10mA ≤ I _{OUT} ≤ 0.8A, V _{IN} =V _{OUT} +2.0V	-	15	30	mV
Quiescent Current	I _{B1}	V _{IN} =V _{OUT} +1.25V, I _{OUT} =0A	-	4.2	10	mA
	I _{B2}	V _{IN} =10V, I _{OUT} =0A	-	4.2	10	
Output Noise Voltage	V _{NO}	V _{IN} =V _{OUT} +1.25V, I _{OUT} =40mA, 10Hz ≤ f ≤ 10kHz	-	100	-	μVrms
Sort Circuit Current Limit	I _{SC}	V _{IN} =V _{OUT} +2.0V	1.1	-	-	A
Ripple Rejection	R · R	I _{OUT} =40mA, f=120Hz, V _{ripple} =1Vp-p V _{IN} =V _{OUT} +3V	60	80	-	dB
Dropout Voltage	V _D	I _{OUT} =0.8A, V _{IN} =0.95V _{OUT}	-	1.1	1.2	V
Temperature Stability	TCV _O	V _{IN} =V _{OUT} +1.5V, I _{OUT} =10mA	-	0.5	-	%

KIA78Q000PI~KIA78Q050PI

Fig. 3 $V_D - I_{OUT}$

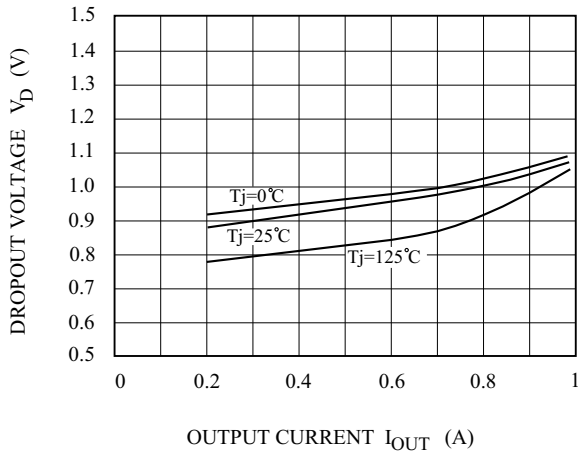

Fig. 4 $V_{REF} - T_j$

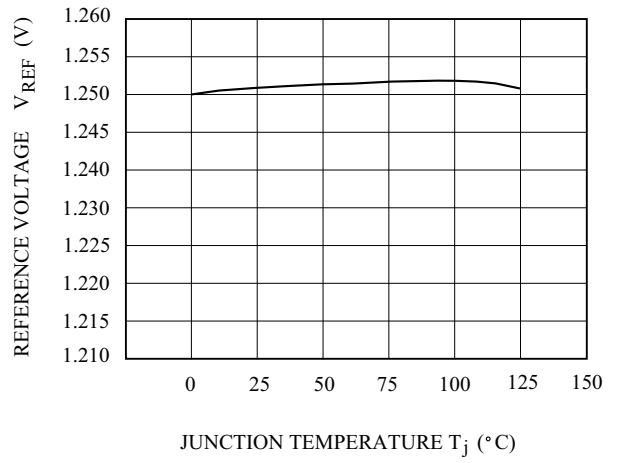

Fig.5 $I_{OUT(MIN)} - T_j$

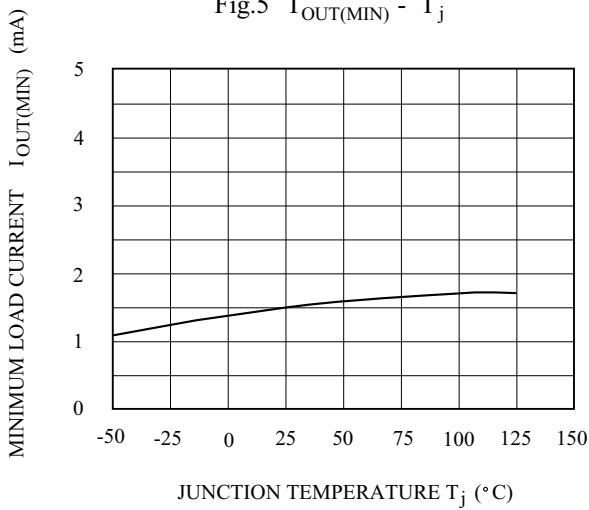

Fig.6 $I_{ADJ} - T_j$

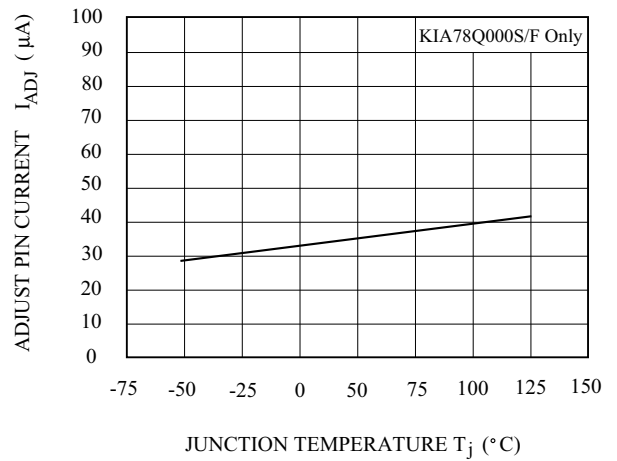

Fig.7 $I_{SC} - T_j$

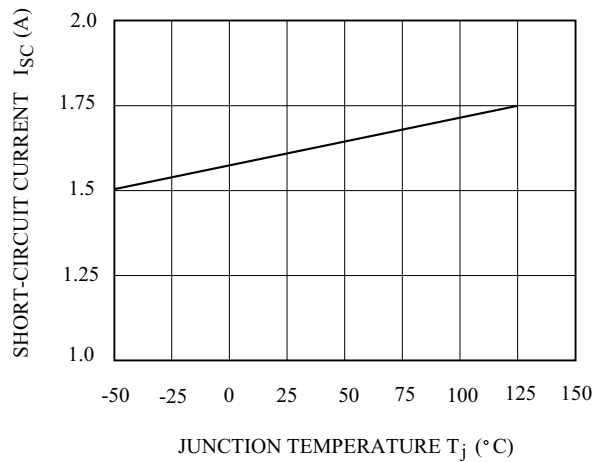
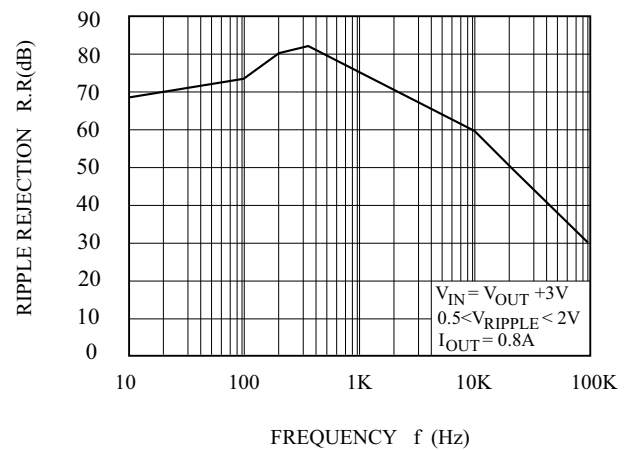

Fig.8 R.R-f



KIA78Q000PI~KIA78Q050PI

Fig.9 P_D - T_a

