

Medium Voltage Fuses

2,400 - 38,000 VAC • Current-Limiting



Current-limiting “E” and “R” rated fuses are equipped with a mechanical indicator or striker pin that protrudes through the fuse cap upon operation of the fuse. This provides visual identification of a blown fuse and can be used as a trigger for external devices.

Note: Extension distance 1/2" min; extension force 2lb. min

General Information

The terms “Medium Voltage” and “High Voltage” have been used interchangeably by many people to describe fuses operating above 600 volts. Technically speaking, “medium voltage” fuses are those intended for the voltage range from 2,400 to 38,000 VAC. “High voltage” fuses are for circuits carrying voltages greater than 38,000 VAC.

“E” rated fuses are considered to be general purpose fuses and can be used to protect against low and high values of fault current. “R” rated fuses are designed for back-up protection. They must be used in series with other devices such as motor overload relays in order to achieve both overload and short-circuit protection.

Medium voltage fuses are not intended to provide overload protection in the same sense as fuses rated 600 volts or less. Medium voltage fuse current ratings do not have the same meanings as the ampere ratings of low voltage fuses.

All medium voltage fuses are limited in their ability to interrupt low value overcurrents, especially those between 100% and 200% of the fuse’s continuous current rating. They are designed to carry their rated current without exceeding the temperature rise permitted by NEMA and ANSI standards.

Additional application data can be found in the Fuse Application section of this catalog.

Littelfuse now offers a complete selection of “E” and “R” rated medium voltage fuses for the protection of transformers, potential transformers, feeders, and motor circuits. Single, double, and triple barrel designs are available to cover a wide range of current, voltage, and interrupting ratings. Conventional ferrule type, clip lock, and bolt-in mounting configurations are now available for virtually any application. Hermetically sealed fuses for use in hazardous environments are also offered.

Contact the factory or your local Littelfuse representative for additional fuse ratings or custom mounting configurations.

24 Hour Emergency Service is available. Call 847 824 1188.

Applications

- Power Transformer Protection
- Potential Transformer Protection
- Motor Controller Back-up Protection
- Fused Switches
- Feeder Circuits



Bolt-in Mount Fuses

E Rated Medium Voltage Fuses

Current-Limiting

“E” Rated fuses have time current characteristics designed to provide current-limiting protection for power transformers, potential transformers, power centers, feeder centers, and unit sub stations. When properly applied, they can protect against high and low fault currents.

NEMA Standards for “E” rated medium voltage fuses require that fuses rated 100E or less open within 300 seconds (5 minutes) when subjected to an RMS value of 200-240% of the fuse continuous current rating; and fuses with an “E” rating larger than 100E must open within 600 seconds (10 minutes) when subjected to an RMS current of 220-240% of the fuse’s continuous current rating. These values establish one point on the time-current curve.

Application Note:

Since these fuses are used for the protection of general purpose circuits which may contain transformers, motors, and other equipment producing in-rush and/or overload currents, fuses should generally be rated at 140% of the normal full load current, and circuits should be analyzed to ensure that system load currents will not exceed the current rating of the fuse.

Characteristics

Voltage Rating: 2,400 volts – 38,000 volts
Current Range: 10E – 600E

Options

- Hermetically sealed for use in hazardous locations (add “S” suffix to part number)
- Clip-lock (CL) and bolt-in styles available.

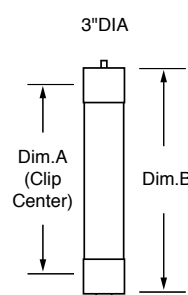

Figure 14

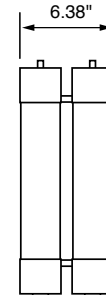

Figure 15

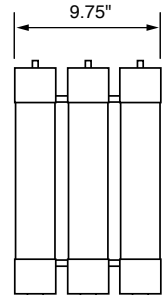

Figure 16

E Rated	Catalog Number	Old Catalog Number	Size	Dim. A (inches)	Dim. B (inches)	Max Interrupting Rating RMS (Asym)	Figure Number
2.75 Max. KV	10E-1C-2.75	LCX 10E	10E	7"	10.875"	80,000	14
	15E-1C-2.75	—	15E	7"	10.875"	80,000	14
	20E-1C-2.75	—	20E	7"	10.875"	80,000	14
	25E-1C-2.75	—	25E	7"	10.875"	80,000	14
	30E-1C-2.75	LCX 30E	30E	7"	10.875"	80,000	14
	40E-1C-2.75	LCX 40E	40E	7"	10.875"	80,000	14
	50E-1C-2.75	LCX 50E	50E	7"	10.875"	80,000	14
	65E-1C-2.75	LCX 65E	65E	7"	10.875"	80,000	14
	80E-1C-2.75	LCX 80E	80E	7"	10.875"	80,000	14
	100E-1C-2.75	LCX 100E	100E	7"	10.875"	80,000	14
	125E-1C-2.75	—	125E	7"	10.875"	80,000	14
	150E-1C-2.75	—	150E	7"	10.875"	80,000	14
	200E-1C-2.75	—	200E	7"	10.875"	80,000	14
	125E-2C-2.75	LCX 125E	125E	7"	10.875"	80,000	15
	150E-2C-2.75	LCX 150E	150E	7"	10.875"	80,000	15
	175E-2C-2.75	LCX 175E	175E	7"	10.875"	80,000	15
	200E-2C-2.75	LCX 200E	200E	7"	10.875"	80,000	15
	225E-2C-2.75	—	225E	7"	10.875"	80,000	15
	250E-2C-2.75	LCX 250E	250E	7"	10.875"	80,000	15
	300E-2C-2.75	LCX 300E	300E	7"	10.875"	80,000	15
	350E-2C-2.75	—	350E	7"	10.875"	80,000	15
400E-2C-2.75	LCX 400E	400E	7"	10.875"	80,000	15	
450E-2C-2.75	—	450E	7"	10.875"	80,000	15	

E Rated Medium Voltage Fuses

Current-Limiting

E Rated	Catalog Number	Old Catalog Number	Size	Dim. A (inches)	Dim. B (inches)	Max Interrupting Rating RMS (Asym)	Diagram
5.5 Max. KV	10E-1C-5.5	—	10E	12"	15.875"	80,000	14
	15E-1C-5.5	—	15E	12"	15.875"	80,000	14
	20E-1C-5.5	—	20E	12"	15.875"	80,000	14
	25E-1C-5.5	—	25E	12"	15.875"	80,000	14
	30E-1C-5.5	LCY 30E	30E	12"	15.875"	80,000	14
	40E-1C-5.5	LCY 40E	40E	12"	15.875"	80,000	14
	50E-1C-5.5	LCY 50E	50E	12"	15.875"	80,000	14
	65E-1C-5.5	LCY 60E	65E	12"	15.875"	80,000	14
	80E-1C-5.5	LCY 80E	80E	12"	15.875"	80,000	14
	100E-1C-5.5	LCY 100E	100E	12"	15.875"	80,000	14
	125E-1C-5.5	LCY 125E	125E	12"	15.875"	80,000	14
	150E-1C-5.5	LCY 150E	150E	12"	15.875"	80,000	14
	175E-1C-5.5	LCY 175E	175E	12"	15.875"	80,000	14
	200E-1C-5.5	LCY 200E	200E	12"	15.875"	80,000	14
	125E-2C-5.5	—	125E	12"	15.875"	80,000	15
	150E-2C-5.5	—	150E	12"	15.875"	80,000	15
	175E-2C-5.5	—	175E	12"	15.875"	80,000	15
	200E-2C-5.5	—	200E	12"	15.875"	80,000	15
	250E-2C-5.5	LCY 250E	250E	12"	15.875"	80,000	15
	300E-2C-5.5	LCY 300E	300E	12"	15.875"	80,000	15
	350E-2C-5.5	LCY 350E	350E	12"	15.875"	80,000	15
	400E-2C-5.5	LCY 400E	400E	12"	15.875"	80,000	15
	450E-2C-5.5	LCY 450E	450E	12"	15.875"	80,000	15
	500E-3C-5.5	—	500E	12"	15.875"	80,000	16
	550E-3C-5.5	—	550E	12"	15.875"	80,000	16
	600E-3C-5.5	—	600E	12"	15.875"	80,000	16

5.5 Max. KV	5NLE-10E	—	10E	14"	17 $\frac{1}{8}$ "	80,000	14
	5NLE-15E	—	15E	14"	17 $\frac{1}{8}$ "	80,000	14
	5NLE-20E	—	20E	14"	17 $\frac{1}{8}$ "	80,000	14
	5NLE-25E	—	25E	14"	17 $\frac{1}{8}$ "	80,000	14
	5NLE-30E	LCU 30E	30E	14"	17 $\frac{1}{8}$ "	80,000	14
	5NLE-40E	LCU 40E	40E	14"	17 $\frac{1}{8}$ "	80,000	14
	5NLE-50E	LCU 50E	50E	14"	17 $\frac{1}{8}$ "	80,000	14
	5NLE-65E	LCU 65E	65E	14"	17 $\frac{1}{8}$ "	80,000	14
	5NLE-80E	LCU 80E	80E	14"	17 $\frac{1}{8}$ "	80,000	14
	5NLE-100E	LCU 100E	100E	14"	17 $\frac{1}{8}$ "	80,000	14
	5NLE-125E	LCU 125E	125E	14"	17 $\frac{1}{8}$ "	80,000	14
	5NLE-150E	LCU 150E	150E	14"	17 $\frac{1}{8}$ "	80,000	14
	5NLE-175E	LCU 175E	175E	14"	17 $\frac{1}{8}$ "	80,000	14
	5NLE-200E	LCU 200E	200E	14"	17 $\frac{1}{8}$ "	80,000	14
	5NLE2-225E	—	225E	14"	17 $\frac{1}{8}$ "	80,000	15
	5NLE2-250E	LCU 250E	250E	14"	17 $\frac{1}{8}$ "	80,000	15
	5NLE2-300E	LCU 300E	300E	14"	17 $\frac{1}{8}$ "	80,000	15
	5NLE2-350E	LCU 350E	350E	14"	17 $\frac{1}{8}$ "	80,000	15
	5NLE2-400E	LCU 400E	400E	14"	17 $\frac{1}{8}$ "	80,000	15
	5NLE2-450E	LCU 450E	450E	14"	17 $\frac{1}{8}$ "	80,000	15

E Rated Medium Voltage Fuses

Current-Limiting

E Rated	Catalog Number	Old Catalog Number	Size	Dim. A (inches)	Dim. B (inches)	Max Interrupting Rating RMS (Asym)	Diagram
8.25 Max. KV	10E-1C-8.25	—	10E	12"	15 ⁷ / ₈ "	80,000	14
	15E-1C-8.25	—	15E	12"	15 ⁷ / ₈ "	80,000	14
	20E-1C-8.25	—	20E	12"	15 ⁷ / ₈ "	80,000	14
	25E-1C-8.25	—	25E	12"	15 ⁷ / ₈ "	80,000	14
	30E-1C-8.25	LDZ 30E	30E	12"	15 ⁷ / ₈ "	80,000	14
	40E-1C-8.25	LDZ 40E	40E	12"	15 ⁷ / ₈ "	80,000	14
	50E-1C-8.25	LDZ 50E	50E	12"	15 ⁷ / ₈ "	80,000	14
	65E-1C-8.25	LDZ 65E	65E	12"	15 ⁷ / ₈ "	80,000	14
	80E-1C-8.25	LDZ 80E	80E	12"	15 ⁷ / ₈ "	80,000	14
	100E-1C-8.25	LDZ 100E	100E	12"	15 ⁷ / ₈ "	80,000	14
	125E-1C-8.25	LDZ 125E	125E	12"	15 ⁷ / ₈ "	80,000	14
	150E-1C-8.25	LDZ 150E	150E	12"	15 ⁷ / ₈ "	80,000	14
	125E-2C-8.25	LDZ 125E	125E	12"	15 ⁷ / ₈ "	80,000	15
	150E-2C-8.25	LDZ 150E	150E	12"	15 ⁷ / ₈ "	80,000	15
	200E-2C-8.25	LDZ 200E	200E	12"	15 ⁷ / ₈ "	80,000	15
	250E-2C-8.25	LDZ 250E	250E	12"	15 ⁷ / ₈ "	80,000	15
	300E-2C-8.25	LDZ 300E	300E	12"	15 ⁷ / ₈ "	80,000	15
	350E-3C-8.25	LDZ 350Z	350E	12"	15 ⁷ / ₈ "	80,000	16
	400E-3C-8.25	—	400E	12"	15 ⁷ / ₈ "	80,000	16

8.25 Max. KV	8NLE-10E	—	10E	14"	17 ⁷ / ₈ "	80,000	14
	8NLE-15E	—	15E	14"	17 ⁷ / ₈ "	80,000	14
	8NLE-20E	—	20E	14"	17 ⁷ / ₈ "	80,000	14
	8NLE-25E	—	25E	14"	17 ⁷ / ₈ "	80,000	14
	8NLE-30E	LCZ 30E	30E	14"	17 ⁷ / ₈ "	80,000	14
	8NLE-40E	LCZ 40E	40E	14"	17 ⁷ / ₈ "	80,000	14
	8NLE-50E	LCZ 50E	50E	14"	17 ⁷ / ₈ "	80,000	14
	8NLE-65E	LCZ 65E	65E	14"	17 ⁷ / ₈ "	80,000	14
	8NLE-80E	LCZ 80E	80E	14"	17 ⁷ / ₈ "	80,000	14
	8NLE-100E	LCZ 100E	100E	14"	17 ⁷ / ₈ "	80,000	14
	8NLE2-100E	LCZ 100E	100E	14"	17 ⁷ / ₈ "	80,000	14
	8NLE2-125E	LCZ 125E	125E	14"	17 ⁷ / ₈ "	80,000	15
	8NLE2-150E	LCZ 150E	150E	14"	17 ⁷ / ₈ "	80,000	15
	8NLE2-200E	LCZ 200E	200E	14"	17 ⁷ / ₈ "	80,000	15
	8NLE2-250E	—	250E	14"	17 ⁷ / ₈ "	80,000	15

E Rated	Catalog Number	Old Catalog Number	Size	Dim. A (inches)	Dim. B (inches)	Max Interrupting Rating RMS (Asym)	Figure Number
15.5 Max. KV	10E-1C-15.5	LDN 10E	10E	15"	18.875"	80,000	14
	15E-1C-15.5	LDN 15E	15E	15"	18.875"	80,000	14
	20E-1C-15.5	LDN 20E	20E	15"	18.875"	80,000	14
	25E-1C-15.5	LDN 25E	25E	15"	18.875"	80,000	14
	30E-1C-15.5	LDN 30E	30E	15"	18.875"	80,000	14
	40E-1C-15.5	LDN 40E	40E	15"	18.875"	80,000	14
	50E-1C-15.5	LDN 50E	50E	15"	18.875"	80,000	14
	65E-1C-15.5	LDN 65E	65E	15"	18.875"	80,000	14
	80E-1C-15.5	LDN 80E	80E	15"	18.875"	80,000	14
	100E-1C-15.5	LDN 100E	100E	15"	18.875"	80,000	14
	65E-2C-15.5	—	65E	15"	18.875"	80,000	15
	80E-2C-15.5	—	80E	15"	18.875"	80,000	15
	100E-2C-15.5	—	100E	15"	18.875"	80,000	15
	125E-2C-15.5	—	125E	15"	18.875"	80,000	15
	150E-2C-15.5	LDN 150E	150E	15"	18.875"	80,000	15
	175E-2C-15.5	LDN 175E	175E	15"	18.875"	80,000	15
	200E-2C-15.5	—	200E	15"	18.875"	80,000	15
	200E-3C-15.5	—	200E	15"	18.875"	80,000	16
	250E-3C-15.5	—	250E	15"	18.875"	80,000	16
	300E-3C-15.5	—	300E	15"	18.875"	80,000	16

Medium Voltage Fuses

E Rated Medium Voltage Fuses

Current-Limiting

E Rated	Catalog Number	Old Catalog Number	Size	Dim. A (inches)	Dim. B (inches)	Max Interrupting Rating RMS (Asym)	Figure Number
	15.5 Max. KV	15GSE-65E	—	65E	18"	21 ⁷ / ₈ "	60,000
15GSE-80E		—	80E	18"	21 ⁷ / ₈ "	60,000	14
15GSE-100E		—	100E	18"	21 ⁷ / ₈ "	60,000	14
15GSE2-125E		—	125E	18"	21 ⁷ / ₈ "	60,000	15
15GSE2-150E		—	150E	18"	21 ⁷ / ₈ "	60,000	15
15GSE2-175E		—	175E	18"	21 ⁷ / ₈ "	60,000	15
15GSE2-200E		—	200E	18"	21 ⁷ / ₈ "	60,000	15

15.5 Max. KV	15NLE-10E	—	10E	20"	23 ³ / ₈ "	60,000	14
	15NLE-15E	—	15E	20"	23 ³ / ₈ "	60,000	14
	15NLE-20E	—	20E	20"	23 ³ / ₈ "	60,000	14
	15NLE-25E	—	25E	20"	23 ³ / ₈ "	60,000	14
	15NLE-30E	LCN 30E	30E	20"	23 ³ / ₈ "	60,000	14
	15NLE-40E	LCN 40E	40E	20"	23 ³ / ₈ "	60,000	14
	15NLE-50E	LCN 50E	50E	20"	23 ³ / ₈ "	60,000	14
	15NLE-65E	LCN 65E	65E	20"	23 ³ / ₈ "	60,000	14
	15NLE-80E	LCN 80ES	80E	20"	23 ³ / ₈ "	60,000	14
	15NLE-100E	LCN 100ES	100E	20"	23 ³ / ₈ "	60,000	14
	15NLE2-80E	LCN 80E	80E	20"	23 ³ / ₈ "	60,000	15
	15NLE2-100E	LCN 100E	100E	20"	23 ³ / ₈ "	60,000	15
	15NLE2-125E	LCN 125X	125E	20"	23 ³ / ₈ "	60,000	15
	15NLE2-150E	LCN 150E	150E	20"	23 ³ / ₈ "	60,000	15
	15NLE2-175E	—	175E	20"	23 ³ / ₈ "	60,000	15
	15NLE2-200E	LCN 200ED	200E	20"	23 ³ / ₈ "	60,000	15
	15NLE3-150E	—	150E	20"	23 ³ / ₈ "	60,000	16
	15NLE3-175E	—	175E	20"	23 ³ / ₈ "	60,000	16
	15NLE3-250E	—	250E	20"	23 ³ / ₈ "	60,000	16
15NLE3-300E	—	300E	20"	23 ³ / ₈ "	60,000	16	

E Rated	Catalog Number	Old Catalog Number	Size	Dim. A (inches)	Dim. B (inches)	Max Interrupting Rating RMS (Asym)	Figure Number
	25.8 Max. KV	15E-1C-25.8	—	15E	21"	24 ⁵ / ₈ "	40,000
20E-1C-25.8		—	20E	21"	24 ⁵ / ₈ "	40,000	14
25E-1C-25.8		—	25E	21"	24 ⁵ / ₈ "	40,000	14
30E-1C-25.8		—	30E	21"	24 ⁵ / ₈ "	40,000	14
40E-1C-25.8		—	40E	21"	24 ⁵ / ₈ "	40,000	14
50E-1C-25.8		—	50E	21"	24 ⁵ / ₈ "	40,000	14
65E-2C-25.8		—	65E	21"	24 ⁵ / ₈ "	40,000	14
80E-2C-25.8		—	80E	21"	24 ⁵ / ₈ "	40,000	15
100E-2C-25.8		—	100E	21"	24 ⁵ / ₈ "	40,000	15

E Rated	Catalog Number	Old Catalog Number	Size	Dim. A (inches)	Dim. B (inches)	Max Interrupting Rating RMS (Asym)	Figure Number
	38 Max. KV	3E-1C-38.0	—	3E	27"	30 ⁵ / ₈ "	20,000
7E-1C-38.0		—	7E	27"	30 ⁵ / ₈ "	20,000	14
10E-1C-38.0		—	10E	27"	30 ⁵ / ₈ "	20,000	14
15E-1C-38.0		—	15E	27"	30 ⁵ / ₈ "	20,000	14
20E-1C-38.0		—	20E	27"	30 ⁵ / ₈ "	20,000	14
25E-1C-38.0		—	25E	27"	30 ⁵ / ₈ "	20,000	14
30E-1C-38.0		—	30E	27"	30 ⁵ / ₈ "	20,000	14
40E-1C-38.0		—	40E	27"	30 ⁵ / ₈ "	20,000	14
50E-2C-38.0		—	50E	27"	30 ⁵ / ₈ "	20,000	15
65E-2C-38.0		—	65E	27"	30 ⁵ / ₈ "	20,000	15
80E-2C-38.0		—	80E	27"	30 ⁵ / ₈ "	20,000	15

Medium Voltage Fuses

E Rated Medium Voltage Fuses

Current-Limiting

Clip Lock Design

The clip lock type designs ensures a positive contact between the fuse and the connection cam. The fuse's clip lock tab slides in between the clip casting and the cam to prevent the fuse from slipping or blowing out of the holder. This positive contact improves heat dissipation and allows fuses to run cooler.

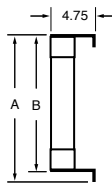

Figure 17

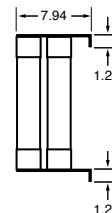

Figure 18

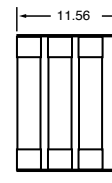

Figure 19



E Rated	Catalog Number	Old Catalog Number	Size	Dim. A (inches)	Dim. B (inches)	Max Interrupting Rating RMS (Asym)	Figure Number
5.5 Max. KV Clip Lock	10E-1CL-5.5	—	10E	16.38"	15.13"	80,000	17
	15E-1CL-5.5	—	15E	16.38"	15.13"	80,000	17
	20E-1C-5.5	—	20E	16.38"	15.13"	80,000	17
	25E-1CL-5.5	—	25E	16.38"	15.13"	80,000	17
	30E-1CL-5.5	—	30E	16.38"	15.13"	80,000	17
	40E-1CL-5.5	—	40E	16.38"	15.13"	80,000	17
	50E-1CL-5.5	—	50E	16.38"	15.13"	80,000	17
	65E-1CL-5.5	—	65E	16.38"	15.13"	80,000	17
	80E-1CL-5.5	—	80E	16.38"	15.13"	80,000	17
	100E-1CL-5.5	—	100E	16.38"	15.13"	80,000	17
	125E-1CL-5.5	—	125E	16.38"	15.13"	80,000	17
	150E-1CL-5.5	—	150E	16.38"	15.13"	80,000	17
	225E-2CL-5.5	—	225E	17.38"	16.13"	80,000	18
	250E-2CL-5.5	—	250E	17.38"	16.13"	80,000	18
	300E-2CL-5.5	—	300E	17.38"	16.13"	80,000	18
	350E-2CL-5.5	—	350E	17.38"	16.13"	80,000	18
	400E-2CL-5.5	—	400E	17.38"	16.13"	80,000	18
	450E-2CL-5.5	—	450E	17.38"	16.13"	80,000	18
	500E-3CL-5.5	—	500E	17.38"	16.13"	80,000	19
	550E-3CL-5.5	—	550E	17.38"	16.13"	80,000	19
600E-3CL-5.5	—	600E	17.38"	16.13"	80,000	19	

E Rated	Catalog Number	Old Catalog Number	Size	Dim. A (inches)	Dim. B (inches)	Max Interrupting Rating RMS (Asym)	Figure Number
8.25 Max. KV Clip Lock	10E-1CL-8.25	—	10E	17.38"	16.13"	80,000	17
	15E-1CL-8.25	—	15E	17.38"	16.13"	80,000	17
	20E-1C-8.25	—	20E	17.38"	16.13"	80,000	17
	25E-1CL-8.25	—	25E	17.38"	16.13"	80,000	17
	30E-1CL-8.25	—	30E	17.38"	16.13"	80,000	17
	40E-1CL-8.25	—	40E	17.38"	16.13"	80,000	17
	50E-1CL-8.25	—	50E	17.38"	16.13"	80,000	17
	65E-1CL-8.25	—	65E	17.38"	16.13"	80,000	17
	80E-1CL-8.25	—	80E	17.38"	16.13"	80,000	17
	100E-1CL-8.25	—	100E	17.38"	16.13"	80,000	17
	125E-2CL-8.25	—	125E	17.38"	16.13"	80,000	18
	150E-2CL-8.25	—	150E	17.38"	16.13"	80,000	18
	175E-2CL-8.25	—	175E	17.38"	16.13"	80,000	18
	200E-2CL-8.25	—	200E	17.38"	16.13"	80,000	18
	225E-2CL-8.25	—	225E	17.38"	16.13"	80,000	18
	250E-2CL-8.25	—	250E	17.38"	16.13"	80,000	18
	300E-2CL-8.25	—	300E	17.38"	16.13"	80,000	18
	350E-3CL-8.25	—	350E	17.38"	16.13"	80,000	19

E Rated	Catalog Number	Old Catalog Number	Size	Dim. A (inches)	Dim. B (inches)	Max Interrupting Rating RMS (Asym)	Figure Number
15.5 Max. KV Clip Lock	10E-1CL-15.5	—	10E	19.8"	18.1"	60,000	17
	15E-1CL-15.5	—	15E	19.8"	18.1"	60,000	17
	20E-1CL-15.5	—	20E	19.8"	18.1"	60,000	17
	25E-1CL-15.5	—	25E	19.8"	18.1"	60,000	17
	30E-1CL-15.5	—	30E	19.8"	18.1"	60,000	17
	40E-1CL-15.5	—	40E	19.8"	18.1"	60,000	17
	50E-1CL-15.5	—	50E	19.8"	18.1"	60,000	17
	65E-1CL-15.5	—	65E	22.81"	21.13"	60,000	17
	80E-1CL-15.5	—	80E	22.81"	21.13"	60,000	17
	100E-1CL-15.5	—	100E	22.81"	21.13"	60,000	17
	125E-2CL-15.5	—	125E	22.81"	19.1"	60,000	18
	150E-3CL-15.5	—	150E	22.81"	19.1"	60,000	19
	175E-3CL-15.5	—	175E	22.81"	19.1"	60,000	19
	200E-3CL-15.5	—	200E	22.81"	19.1"	60,000	19
	225E-3CL-15.5	—	225E	22.81"	19.1"	60,000	19
	250E-3CL-15.5	—	250E	22.81"	19.1"	60,000	19
	300E-3CL-15.5	—	300E	22.81"	19.1"	60,000	19

Medium Voltage Fuses

E Rated Potential Transformer Fuses

Current-Limiting

Potential Transformer (PT) fuses are current-limiting fuses with high interrupting ratings designed for the protection of potential transformers.

Application Note:

When applying fuses for the protection of transformers, the magnetizing current in-rush must be considered. The characteristics of the in-rush, which can be matched with a fuse time-current curve, should be available from the transformer manufacturer.

Characteristics

Voltage Rating: 600VAC – 25,500 VAC

Current Range: 1/2E – 10E

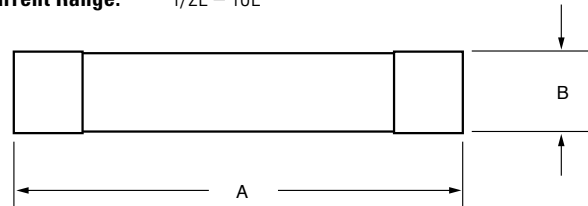

Rated	Catalog Number	Old Catalog Number	Size	Length Dim. A (inches)	Diameter Dim. B (inches)	Max Interrupting Rating RMS (Sym)
600 Volt	3E-4PT-6	—	3E	4.6"	0.8125"	37,500
	5E-4PT-6	—	5E	4.6"	0.8125"	37,500
	7E-4PT-6	—	7E	4.6"	0.8125"	37,500
	10E-4PT-6	—	10E	4.6"	0.8125"	37,500
2.75 Max. kV	500E-4PT-2.4	—	1/2E	4.6"	0.8125"	37,000
	1E-4PT-2.4	LCD 1E-4	1E	4.6"	0.8125"	37,000
	2E-4PT-2.4	LCD 2E-4	2E	4.6"	0.8125"	37,000
2.75 Max. KV	1E-6PT-2.75	—	1E	7.4"	1.5625"	37,500
	2E-6PT-2.75	—	2E	7.4"	1.5625"	37,500
	3E-6PT-2.75	—	3E	7.4"	1.5625"	37,500
	1E-8PT-2.75	—	1E	9.5"	1.5625"	37,000
	2E-8PT-2.75	—	2E	9.5"	1.5625"	37,000
	3E-8PT-2.75	—	3E	9.5"	1.5625"	37,000
4.8 Max. kV	1E-5PT-4.8	LCE 1E-4	1E	5.6"	0.8125"	50,000
	2E-5PT-4.8	LCE 2E-4	2E	5.6"	0.8125"	50,000
5.5 Max. kV	1/2E-6PT-5.5	—	1/2E	7.4"	1.5625"	50,000
	1E-6PT-5.5	—	1E	7.4"	1.5625"	50,000
	2E-6PT-5.5	—	2E	7.4"	1.5625"	50,000
	3E-6PT-5.5	—	3E	7.4"	1.5625"	50,000
	5E-6PT-5.5	—	5E	7.4"	1.5625"	50,000
	1/2E-8PT-5.5	LCQ .5E	1/2E	9.5"	1.5625"	50,000
	1E-8PT-5.5	LCQ 1E	1E	9.5"	1.5625"	50,000
	2E-8PT-5.5	LCQ 2E	2E	9.5"	1.5625"	50,000
	3E-8PT-5.5	LCQ 3E	3E	9.5"	1.5625"	50,000
	5E-8PT-5.5	LCQ 5E	5E	9.5"	1.5625"	50,000
8.25 Max. kV	1/2E-8PT-8.25	—	1/2E	9.5"	1.5625"	50,000
	1E-8PT-8.25	—	1E	9.5"	1.5625"	50,000
	2E-8PT-8.25	—	2E	9.5"	1.5625"	50,000
	3E-8PT-8.25	—	3	9.5"	1.5625"	50,000
15.5 Max. kV	1/2E-11PT-15.5	LCT .5E	1/2E	12.8"	1.5625"	35,000
	1E-11PT-15.5	LCT 1E	1E	12.8"	1.5625"	35,000
	2E-11PT-15.5	LCT 2E	2E	12.8"	1.5625"	35,000
	3E-11PT-15.5	LCT 3E	3E	12.8"	1.5625"	35,000
	3E-16PT-15.5	—	3E	17.5"	1.5625"	35,000
25.8 Max. kV	1/2E-16PT-25.5	LCJ 1E-4	1/2E	17.5"	1.5625"	43,500
	1E-16PT-25.5	LCJ 2E-4	1E	17.5"	1.5625"	43,500

Medium Voltage Fuses

Live Parts



Live parts are available for mounting "E", "R", and "PT" single, double, and triple barrel fuses. Mounting clips are available for ferrule type and clip lock style fuses. All clips are sold in pairs. Contact factory for additional live parts.

Part Number: 700-156*

System Number: 0700156.Z

For use with 1-9/16" to 1-5/8" (1.625") diameter PT fuses.

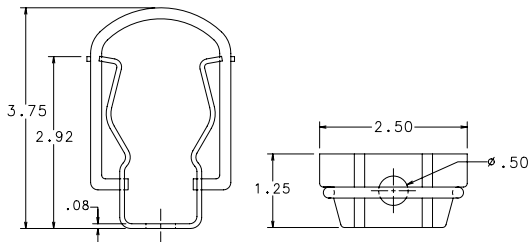

Part Number: 700-300*

System Number: 0700300.Z

For use with 3" diameter fuses.

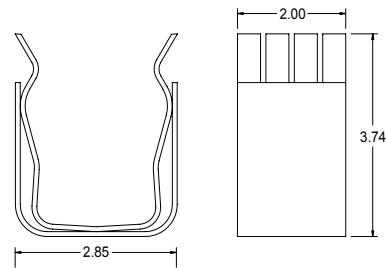

Part Number: 700-500*

System Number: 0700500.Z

For use with all 13/16" (.8125") diameter PT fuses.

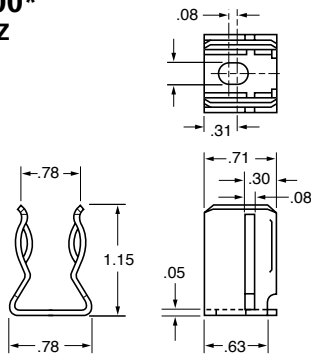

Part Number: 700-530*

System Number: 0700530.Z

For use with all 3" diameter fuses.

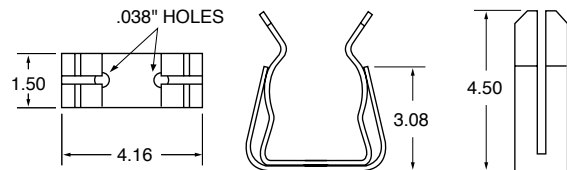

Part Number: 700-520-CL*

System Number: 0700520.ZXCL

Clip Lock Design (For CL-14)

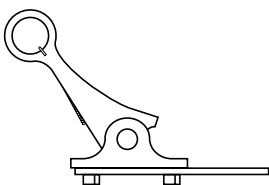

* One Pair. Dimensions for reference only.

Mounting Details for Clip Lock

