

---

# Two Channel High Resolution Optical Incremental Encoder Modules

## Technical Data

---

### HEDS-9000/9100/9200 Extended Resolution Series

---

#### Features

- **High Resolution: Up to 2048 Cycles per Revolution**
- **Up to 8192 Counts per Revolution with 4X Decoding**
- **Two Channel Quadrature Output**
- **Low Cost**
- **Easy to Mount**
- **No Signal Adjustment Required**
- **Small Size**
- **-40°C to 100 °C Operating Temperature**
- **TTL Compatible**
- **Single 5 V Supply**

#### Description

The HEDS-9000 Options T and U and the HEDS-9100 Options B and J are high resolution two channel rotary incremental encoder modules. These options are an extension of our popular HEDS-9000 and HEDS-9100 series. When used with a code-wheel, these modules detect relative rotary position. The HEDS-9200 Option 300 and 360 are high resolution linear encoder modules. When used with a

codestrip, these modules detect relative linear position.

These modules consist of a lensed Light Emitting Diode (LED) source and detector IC enclosed in a small C shaped plastic package. Due to a highly collimated light source and unique photodetector array, these modules provide a highly reliable quadrature output.

The HEDS-9000 and HEDS-9100 are designed for use with codewheels which have an optical radius of 23.36 mm and 11 mm respectively. The HEDS-9200 is designed for use with a linear codestrip.

These components produce a two channel quadrature output which can be accessed through five 0.025 inch square pins located on 0.1 inch centers.

The resolution of the HEDS-9000 Options T and U are 2000 and 2048 counts per revolution respectively. The HEDS-9100 Options B and J are 1000 and 1024 counts per revolution

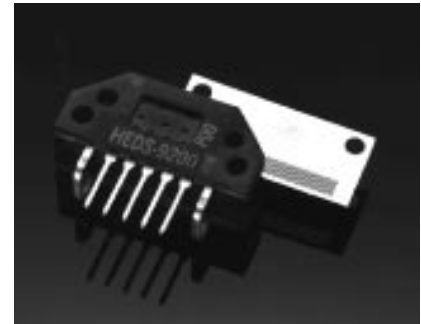

respectively. The HEDS-9200 Option 300 and 360 linear encoder modules have resolutions of 300 and 360 lines per inch.

Consult local Agilent sales representatives for other resolutions.

**Note:** Agilent Technologies encoders are not recommended for use in safety critical applications. Eg. ABS braking systems, power steering, life support systems and critical care medical equipment. Please contact sales representative if more clarification is needed.

**ESD WARNING: NORMAL HANDLING PRECAUTIONS SHOULD BE TAKEN TO AVOID STATIC DISCHARGE.**

## Block Diagram

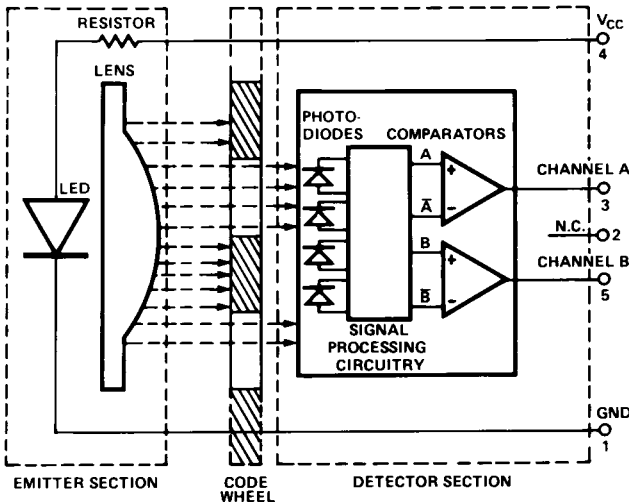

## Output Waveforms

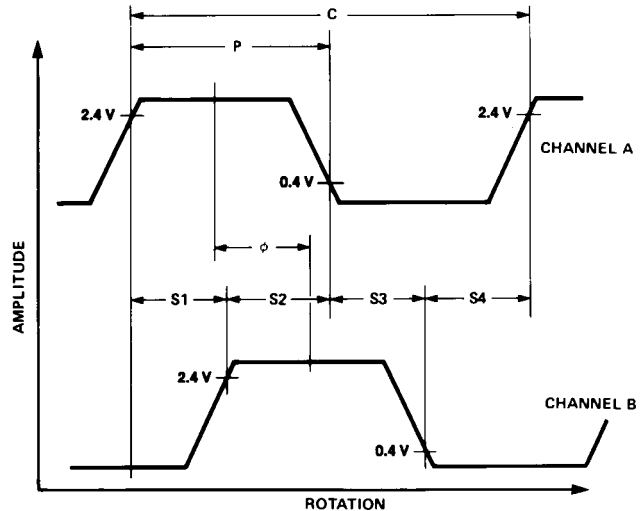

## Theory of Operation

The diagram shown on the following page is a block diagram of the encoder module. As seen in this block diagram, the module contains a single LED as its light source. The light is collimated into a parallel beam by means of a single polycarbonate lens located directly over the LED. Opposite the emitter is the integrated detector circuit. This IC consists of multiple sets of photodetectors and the signal processing circuitry necessary to produce the digital waveforms.

The codewheel/codestrip passes between the emitter and detector, causing the light beam to be interrupted by the pattern of spaces and bars on the codewheel. The photodiodes which detect these interruptions are arranged in a pattern that corresponds to the codewheel/codestrip. These detectors are also spaced such that a light period on one pair of detectors corresponds to a dark period on the adjacent pair of detectors. The photodiode outputs are then fed

through the signal processing circuitry resulting in A,  $\bar{A}$ , B, and  $\bar{B}$ . Comparators receive these signals and produce the final outputs for channels A and B. Due to this integrated phasing technique, the digital output of channel A is in quadrature with that of channel B (90 degrees out of phase).

## Definitions

**Count (N):** The number of bar and window pairs or counts per revolution (CPR) of the codewheel.

**1 cycle (C):** 360 electrical degrees ( $^{\circ}e$ ), 1 bar and window pair.

**1 Shaft Rotation:** 360 mechanical degrees, N cycles.

**Pulse Width (P):** The number of electrical degrees that an output is high during 1 cycle. This value is nominally  $180^{\circ}e$  or  $1/2$  cycle.

**Pulse Width Error ( $\Delta P$ ):** The deviation, in electrical degrees of the pulse width from its ideal value of  $180^{\circ}e$ .

**State Width (S):** The number of electrical degrees between a

transition in the output of channel A and the neighboring transition in the output of channel B. There are 4 states per cycle, each nominally  $90^{\circ}e$ .

**State Width Error ( $\Delta S$ ):** The deviation, in electrical degrees, of each state width from its ideal value of  $90^{\circ}e$ .

**Phase ( $\phi$ ):** The number of electrical degrees between the center of the high state of channel A and the center of the high state of channel B. This value is nominally  $90^{\circ}e$  for quadrature output.

**Phase Error ( $\Delta\phi$ ):** The deviation of the phase from its ideal value of  $90^{\circ}e$ .

**Direction of Rotation:** When the codewheel rotates in the direction of the arrow on top of the module, channel A will lead channel B. If the codewheel rotates in the opposite direction, channel B will lead channel A.

**Optical Radius ( $R_{op}$ ):** The distance from the codewheel's center of rotation to the optical center (O.C.) of the encoder module.

## Package Dimensions

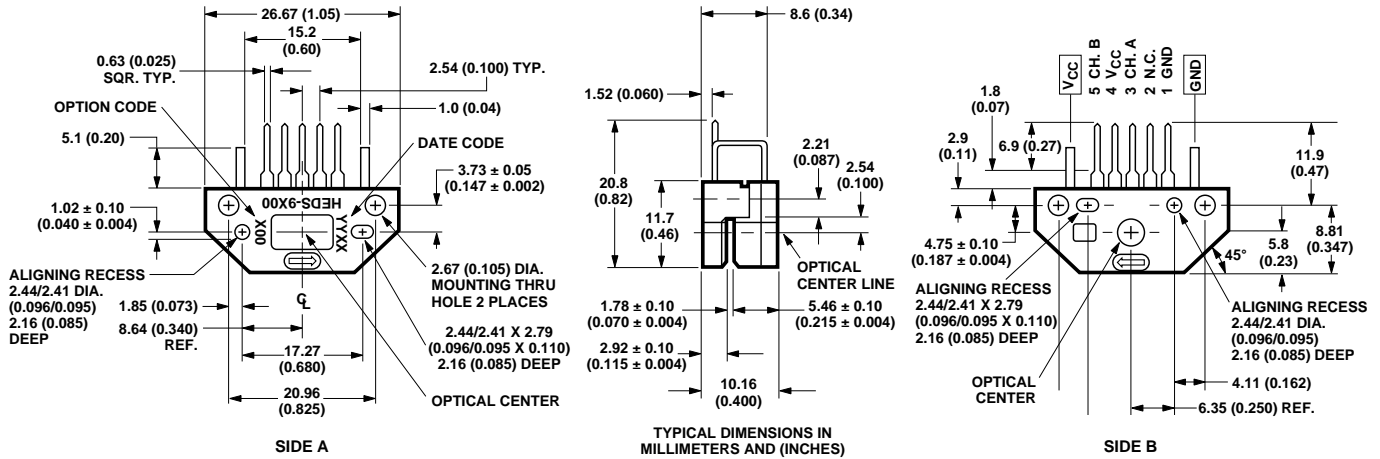

## Absolute Maximum Ratings

Storage Temperature, T <sub>S</sub>	-40°C to 100°C
Operating Temperature, T <sub>A</sub>	-40°C to 100°C
Supply Voltage, V <sub>CC</sub>	-0.5 V to 7 V
Output Voltage, V <sub>O</sub>	-0.5 V to V <sub>CC</sub>
Output Current per Channel, I <sub>out</sub>	-1.0 mA to 5 mA

## Recommended Operating Conditions

Parameter	Symbol	Min.	Typ.	Max.	Units	Notes
Temperature	T <sub>A</sub>	-40		100	°C	
Supply Voltage	V <sub>CC</sub>	4.5	5.0	5.5	Volts	Ripple < 100 mV <sub>p-p</sub>
Load Capacitance	C <sub>L</sub>			100	pF	3.3 kΩ pull-up resistor
Count Frequency	f			100	kHz	Velocity (rpm) x N/60
Shaft Axial Play				± 0.125 ± 0.005	mm in.	

**Note:** The module performance is guaranteed to 100 kHz but can operate at higher frequencies. For frequencies above 100 kHz it is recommended that the load capacitance not exceed 25 pF and the pull up resistance not exceed 3.3 kΩ. For typical module performance above 100 kHz please see derating curves.

## Electrical Characteristics

Electrical Characteristics over Recommended Operating Range, typical at 25°C.

Parameter	Symbol	Min.	Typical	Max.	Units	Notes
Supply Current	$I_{CC}$	30	57	85	mA	
High Level Output Voltage	$V_{OH}$	2.4			Volts	$I_{OH} = -200 \mu\text{A max.}$
Low Level Output Voltage	$V_{OL}$			0.4	Volts	$I_{OL} = 3.86 \text{ mA}$
Rise Time	$t_r$		180		ns	$C_L = 25 \text{ pF}$ $R_L = 3.3 \text{ k}\Omega \text{ pull-up}$
Fall Time	$t_f$		40		ns	

## Encoding Characteristics

Encoding Characteristics over Recommended Operating Range and Recommended Mounting Tolerances.

These Characteristics do not include codewheel/codestrip contribution. The Typical Values are averages over the full rotation of the codewheel. For operation above 100 kHz, see frequency derating curves.

Description	Symbol	Typical	Maximum	Units
Pulse Width Error	$\Delta P$	5	45	°e
Logic State Width Error	$\Delta S$	3	45	°e
Phase Error	$\Delta\phi$	2	15	°e

**Note:** Module mounted on tolerance circle of  $\pm 0.13 \text{ mm}$  ( $\pm 0.005 \text{ in.}$ ) radius referenced from module Side A aligning recess centers. 3.3 k $\Omega$  pull-up resistors used on all encoder module outputs.

## Derating Curves over Extended Operating Frequencies (HEDS-9000/9100/9200 Extended Series)

Below are the derating curves for state, duty, phase and  $V_{OH}$  over extended operating frequencies of up to 240 kHz (recommended maximum frequency is 100 kHz). The curves were derived using standard TTL load.  $-40^{\circ}\text{C}$  operation is not feasible above 160 kHz because  $V_{OH}$  will drop below 2.4 V (the minimum TTL for logic state high) beyond that frequency.

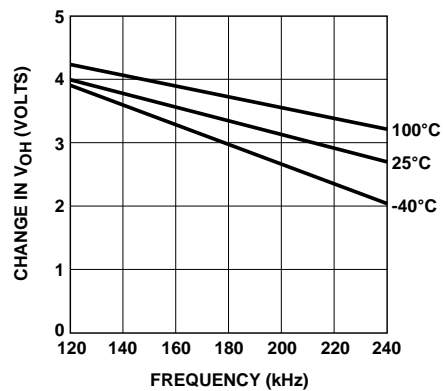
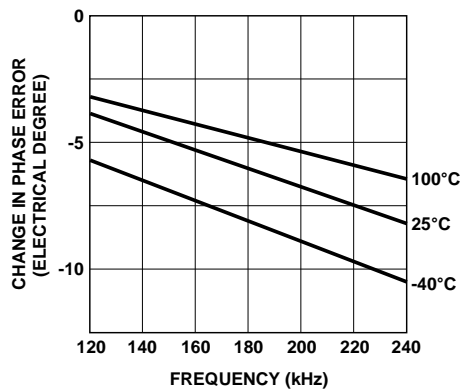
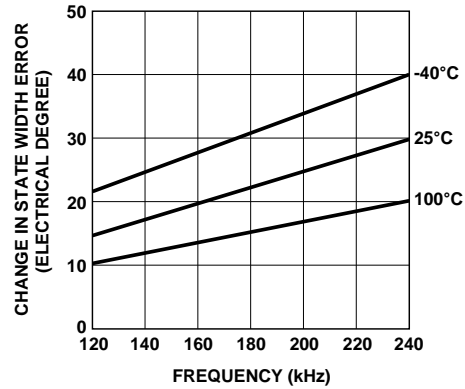
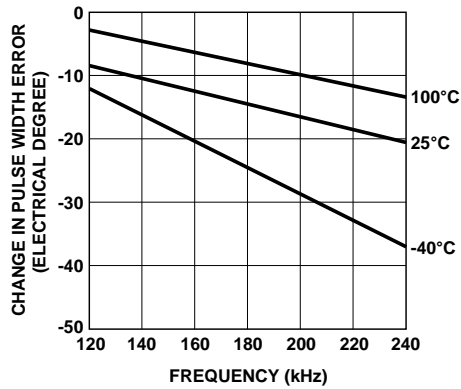

## Gap Setting for Rotary and Linear Modules

Gap is the distance between the image side of the codewheel and the detector surface of the module. This gap dimension must always be met and codewheel warp and shaft end play must stay within this range. This dimension is shown in Figure 1.

## Mounting Considerations for Rotary Modules

Figure 2 shows a mounting tolerance *requirement* for proper operation of the high resolution rotary encoder modules. The Aligning Recess Centers must be located within a tolerance circle of 0.13 mm (0.005 in.) radius from the nominal locations. This tolerance must be maintained whether the module is mounted with side A as the mounting plane using aligning pins (see Figure 3), or mounted with Side B as the mounting plane using an alignment tool.

## Mounting with Aligning Pins

The high resolution rotary encoder modules can be mounted using aligning pins on the motor base. (Agilent does not provide aligning pins.) For this configuration, Side A *must* be used as the mounting plane. The Aligning Recess Centers must be located within the 0.13 mm (0.005 in.) R Tolerance Circle as explained above. Figure 3 shows the necessary dimensions.

## Mounting with Alignment Tools

Agilent offers alignment tools for mounting Agilent encoder modules in conjunction with Agilent codewheels, using side B as the mounting plane. Please refer to the Agilent codewheel data sheet for more information.

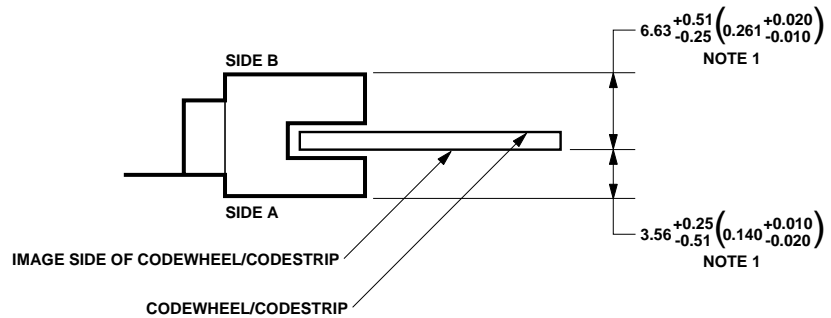

NOTES: 1. THESE DIMENSIONS INCLUDE CODEWHEEL/CODESTRIP WARP AND SHAFT END PLAY.  
2. DIMENSIONS IN MILLIMETERS AND (INCHES).

Figure 1. Module Gap Setting.

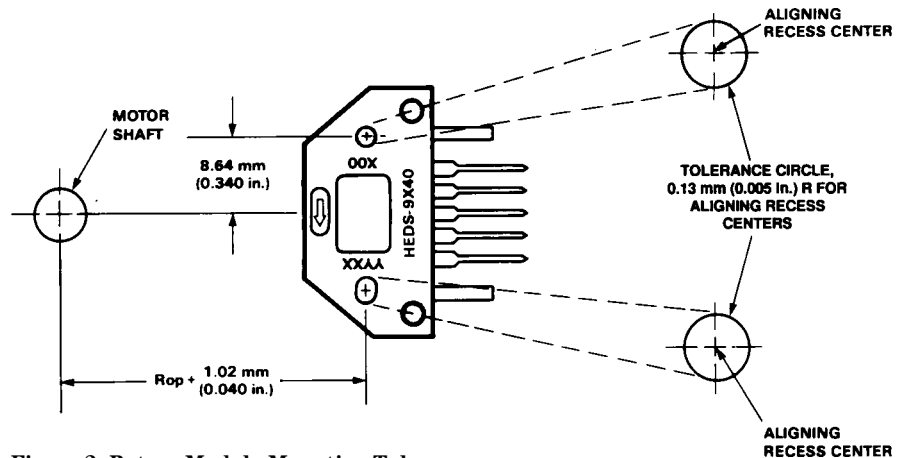
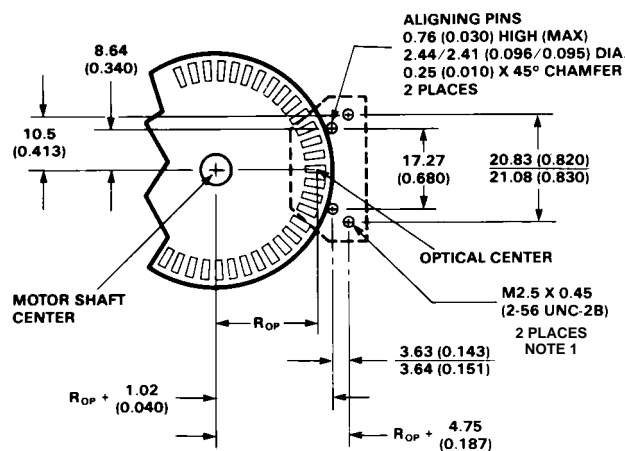

Figure 2. Rotary Module Mounting Tolerance.



NOTE 1: RECOMMENDED MOUNTING SCREW TORQUE IS 4 KG-CM (3.5 IN-LBS).

Figure 3. Mounting Plane Side A.

### Mounting Considerations for Linear Modules

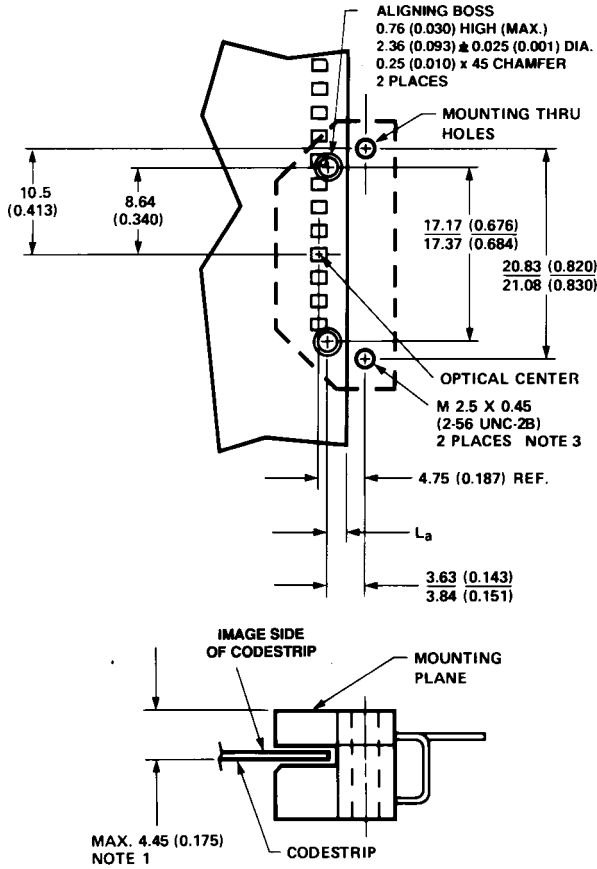

Mounting Plane Side A

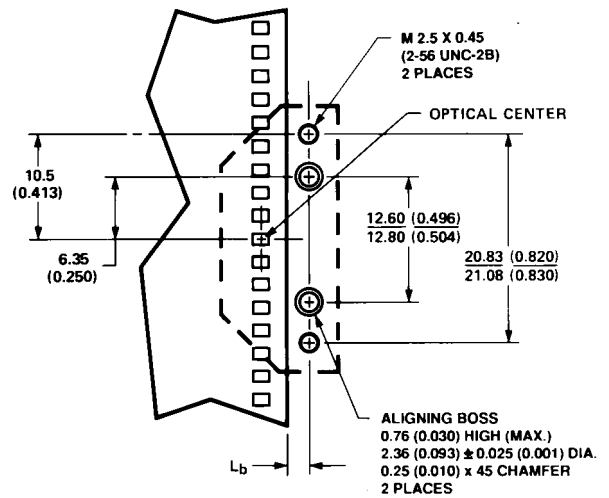
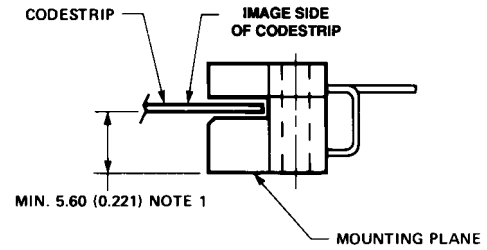

Mounting Plane Side B

- NOTES:
1. THESE DIMENSIONS INCLUDE CODESTRIP WARP.
  2. REFERENCE DEFINITIONS OF  $L_a$  AND  $L_b$  ON THE FOLLOWING PAGE.
  3. MAXIMUM RECOMMENDED MOUNTING SCREW TORQUE IS 4 kg-cm (3.5 in-lbs).

## Recommended Codewheel Characteristics

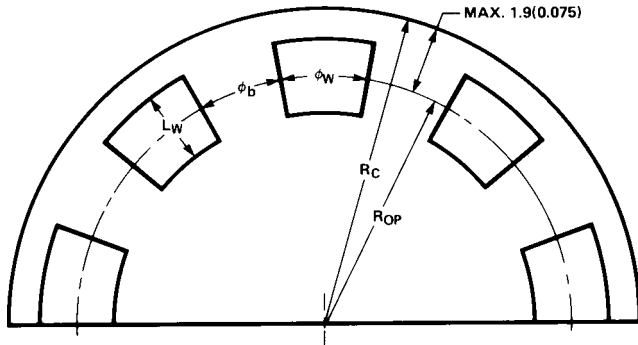

Parameter	Symbol	Minimum	Maximum	Units	Notes
Window/Bar Ratio	$\phi_w/\phi_b$	0.7	1.4		
Window Length	$L_w$	1.8 (0.07)		mm (inch)	
Absolute Maximum Codewheel Radius	$R_c$		$R_{op} + 1.9$ (0.075)	mm (inch)	Includes eccentricity errors

## Recommended Codestrip Characteristics and Alignment

Codestrip design must take into consideration mounting as referenced to either side A or side B (see Figure 4).

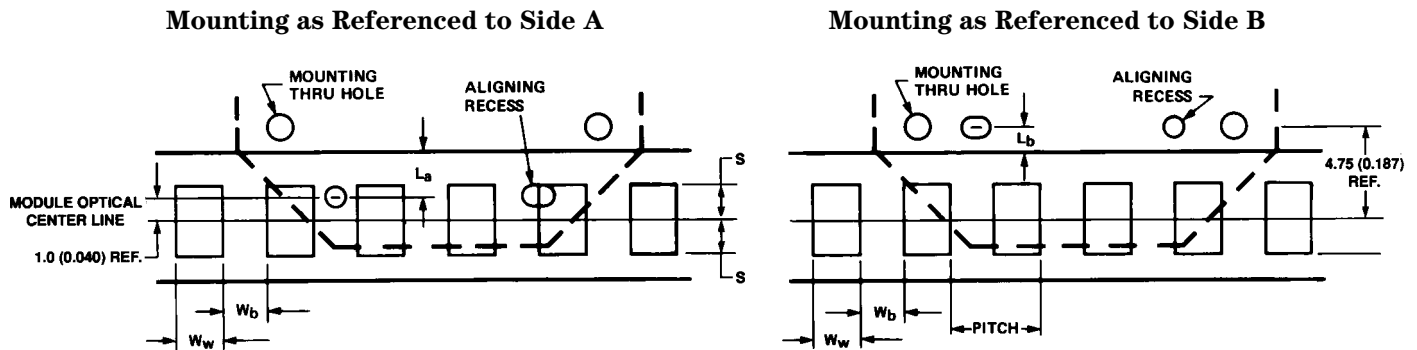

Figure 4. Codestrip Design

**STATIC CHARGE WARNING: LARGE STATIC CHARGE ON CODESTRIP MAY HARM MODULE. PREVENT ACCUMULATION OF CHARGE.**

Parameter	Symbol	Mounting Ref. Side A	Mounting Ref. Side B	Units
Window/Bar Ratio	$W_w/W_b$	0.7 min., 1.4 max.	0.7 min., 1.4 max.	
Window Distance	$L$	$L_a \leq 0.51$ (0.020)	$L_b \geq 3.23$ (0.127)	mm (inch)
Window Edge to Module Opt Center Line	$S$	0.90 (0.035) min.	0.90 (0.035) min.	mm (inch)
Parallelism Module to Codestrip	$\alpha$	1.3 max.	1.3 max.	deg.

**Note:** All parameters and equations must be satisfied over the full length of codestrip travel including maximum codestrip runout.



## Connectors

Manufacturer	Part Number	Mounting Surface
AMP	103686-4 640442-5	Both Side B
DuPont	65039-032 with 4825X-000 term.	Both
Agilent	HEDS-8902 with 4-wire leads	Side B (see Fig. 7)
Molex	2695 series with 2759 series term.	Side B

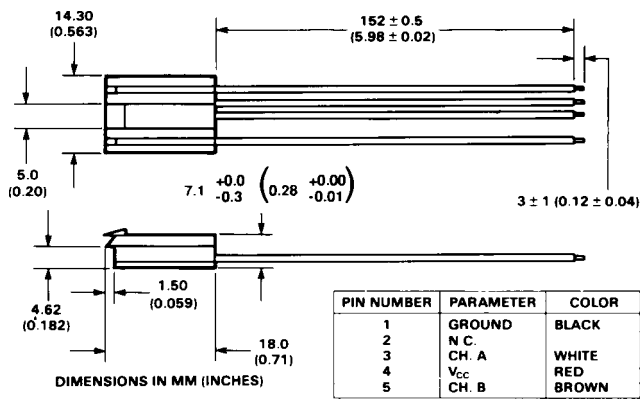
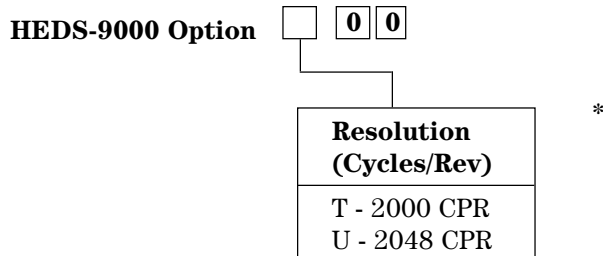

Figure 7. HEDS-8902 Connector.

## Ordering Information

### Two Channel Encoder Modules with a 23.36 mm Optical Radius



### Two Channel Encoder Modules with an 11.00 mm Optical Radius

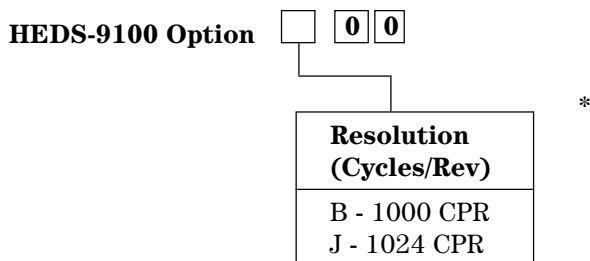

### Two Channel Linear Encoder Module

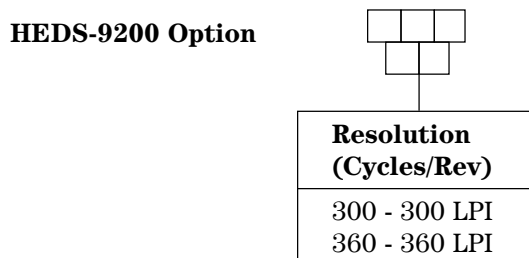

**Note:** For lower resolutions, please refer to HEDS-9000/9100 and HEDS-9200 data sheets for detailed information.

### \*Codewheel Information

For information on matching codewheels and accessories for use with Agilent rotary encoder modules, please refer to the Agilent Codewheel Data sheet HEDS-5120/6100, HEDG-5120/6120, HEDM-5120/6120.

**[www.agilent.com/semiconductors](http://www.agilent.com/semiconductors)**

For product information and a complete list of distributors, please go to our web site.

For technical assistance call:

Americas/Canada: +1 (800) 235-0312 or  
(408) 654-8675

Europe: +49 (0) 6441 92460

China: 10800 650 0017

Hong Kong: (+65) 6271 2451

India, Australia, New Zealand: (+65) 6271 2394

Japan: (+81 3) 3335-8152(Domestic/International), or 0120-61-1280(Domestic Only)

Korea: (+65) 6271 2194

Malaysia, Singapore: (+65) 6271 2054

Taiwan: (+65) 6271 2654

Data subject to change.

Copyright © 2002 Agilent Technologies, Inc.

Obsoletes 5988-5855EN

May 8, 2002

5988-6710EN