



SPX2930

150 mA Low Dropout Voltage Regulator

FEATURES

- Output Current in Excess of 150mA
- 3V, 3.3V, 3.5V, 4.0V, 4.5V & 5.0V Versions Available
- Very Low Quiescent Current
- Input-Output Differential Less than 0.6V
- 60V Load Dump Protection
- -50V Reverse Transient Protection
- Internal Thermal Overload Protection
- Reverse Battery Protection
- Short Circuit Protection
- Available in TO-220, TO-92, SO-8, SOT-89 Packages
- Similar to Industry Standard LM2930

APPLICATIONS

- Cordless Telephones
- Portable Consumer Equipment
- Portable Instrumentation
- Radio Control Systems

PRODUCT DESCRIPTION

The SPX2930 is a positive Low Power Voltage Regulator. This device is an excellent choice for use in battery-powered applications, such as cordless telephones, radio control systems, and automotive applications. The SPX2930 was originally designed for automotive applications, all circuitry is protected from reverse battery installations. During line transients, such as a load dump (+60V) when the input voltage to the regulator exceed its maximum operating voltage, this device will automatically shut down to protect both internal circuits as well as the load. The SPX2930 is offered as a 3.0V, 3.3V, 3.5V, 4.5V, 5.0V fixed output in 3-pin SOT-89, TO-92/TO-220 packages compatible with other 5V regulators. The SPX2930 is also offered in 5V SO-8 package.

PIN CONNECTIONS

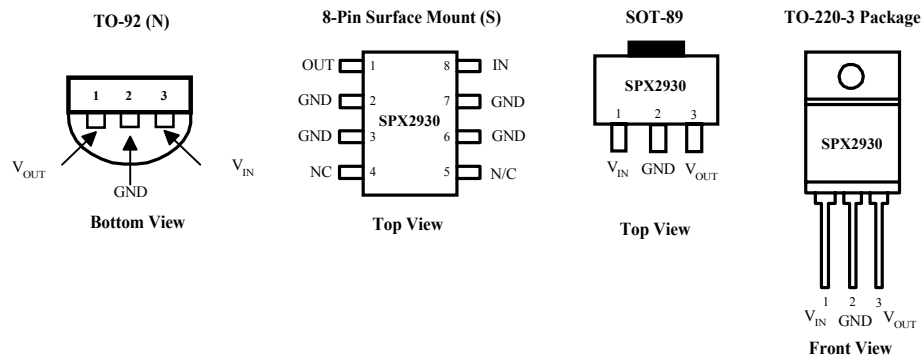

ABSOLUTE MAXIMUM RATINGS

Power Dissipation.....	Internally Limited
Lead Temp. (soldering, 10 Seconds).....	230°C
Storage Temperature Range	-65° to +150°C
Operating Junction Temperature Range	-40° to +85°C
Maximum Junction Temperature	+125°C
ESD Rating.....	2KV

Over Voltage Protection.....	60V
Reverse Voltage (100mS).....	-50V
Reverse Voltage(DC).....	-15V
Input Supply Voltage	-0.3 to +26V

ELECTRICAL CHARACTERISTICS at $V_s=14V$, $T_a=25^\circ C$, $I_o=150mA$, $C_2=100\mu F$, unless otherwise specified.

Parameter	Conditions	SPX2930		
		Typ	Max	Units
3.0 Volt Version				
SPX2930-3.0				
Output Voltage	$6V < V_{in} < 26V$, $I_o = 150mA$ Over Temp.	3.00	3.09	V
		3.00	3.15	V
3.3 Volt Version				
SPX2930-3.3				
Output Voltage	$6V < V_{in} < 26V$, $I_o = 150mA$ Over Temp.	3.30	3.39	V
		3.30	3.43	V
4.0 Volt Version				
SPX2930-4.0				
Output Voltage	$6V < V_{in} < 26V$, $I_o = 150mA$ Over Temp.	4.0	4.1	V
		4.0	4.14	V
5 Volt Version				
SPX2930-5.0				
Output Voltage	$6V < V_{in} < 26V$, $I_o = 150mA$ Over Temp.	5.00	5.25	V
			5.5	V
Long Term Stability		20		mV/1000
Line Regulation	$9V < V_{in} < 16V$ $6V < V_{in} < 26V$	4.0	30	mV
Load Regulation	$5mA < I_o < 150mA$	14	50	mV
Dropout Voltage	$I_o = 10mA$ $I_o = 50mA$ $I_o = 150mA$	0.05	0.2	V
		0.07	0.1	V
		0.3	0.6	V
Quiescent Current	$I_o < 10mA$, $6V < V_{in} < 26V$ $-40^\circ C < T_j < 125^\circ C$ $I_o = 150mA$, $V_{in} = 14V$, $T_j = 25^\circ C$	0.4	1.0	mA
		15		mA
Maximum Operational Input Voltage		33		V
Maximum Line Transient	$R_L = 500\Omega$, $V_o < 5.5V$, 100ms	50		V
Reverse Polarity Input Voltage, DC	$V_o > -0.3V$, $R_L = 500\Omega$	30		V
Reverse Polarity Input Voltage, Transient	1% Duty Cycle, $\tau < 100ms$, $R_L = 500\Omega$	-80		V
Current Limit		400	450	mA
Output Noise Voltage	10Hz-100kHz, $C_{out} = 100\mu F$	500		μV_{rms}
Ripple Rejection	$f_o = 120Hz$	80		dB

TYPICAL CHARACTERISTICS

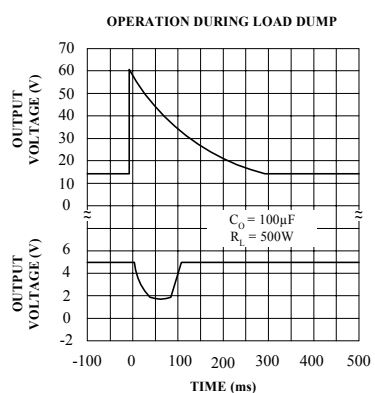
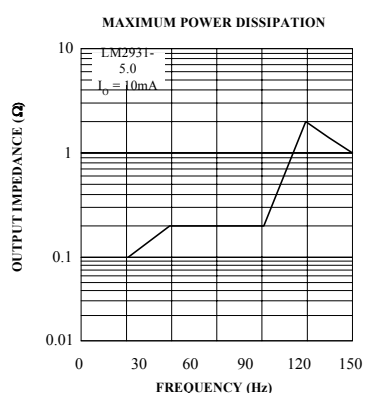
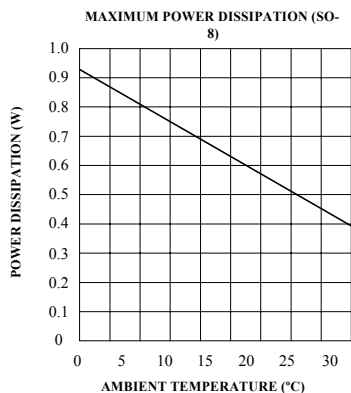
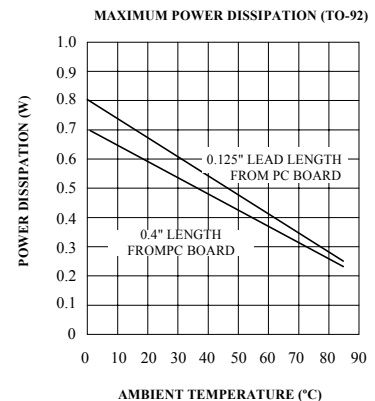
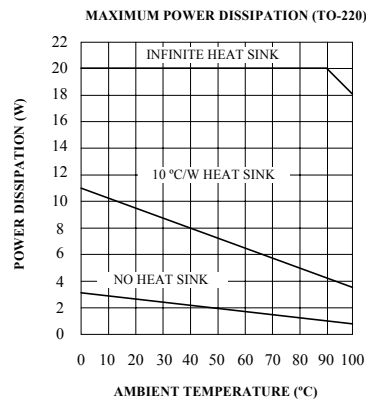
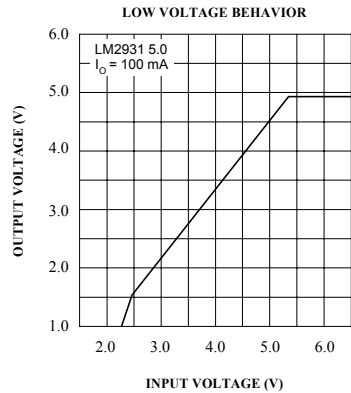
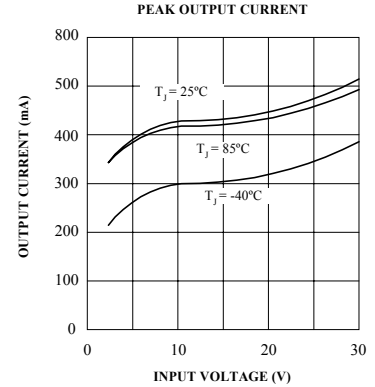
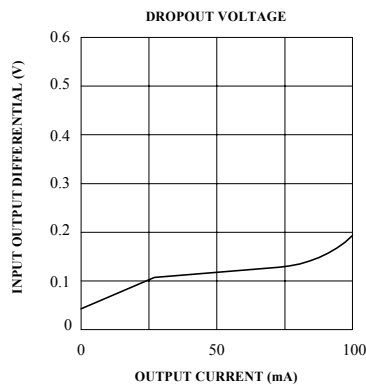
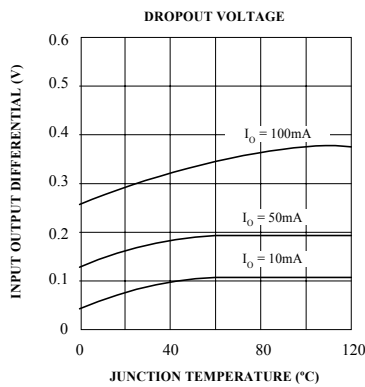
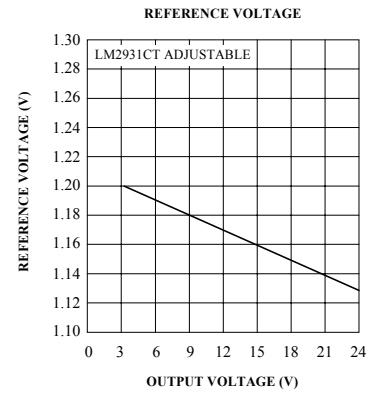
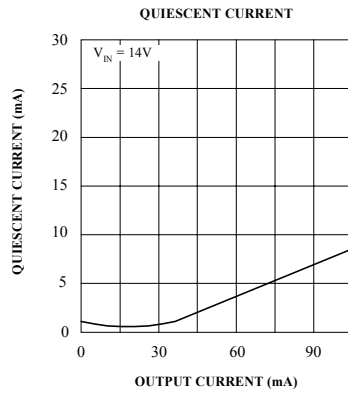
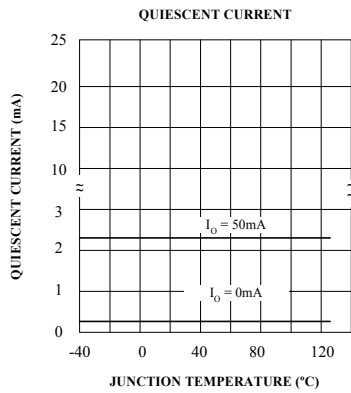

ORDERING INFORMATION

Ordering No.	Output Voltages	Packages
SPX2930N-3.0	3.0V	3 Lead TO-92
SPX2930N-3.3	3.3V	3 Lead TO-92
SPX2930N-3.5	3.5V	3 Lead TO-92
SPX2930N-4.0	4.0V	3 Lead TO-92
SPX2930N-4.5	4.5V	3 Lead TO-92
SPX2930N-5.0	5.0V	3 Lead TO-92
SPX2930S-3.0	3.0V	8 Lead SOIC
SPX2930S-3.3	3.3V	8 Lead SOIC
SPX2930S-3.5	3.5V	8 Lead SOIC
SPX2930S-4.0	4.0V	8 Lead SOIC
SPX2930S-4.5	4.5V	8 Lead SOIC
SPX2930S-5.0	5.0V	8 Lead SOIC
SPX2930M1-3.0	3.0V	3 Lead SOT-89
SPX2930M1-3.3	3.3V	3 Lead SOT-89
SPX2930M1-3.5	3.5V	3 Lead SOT-89
SPX2930M1-4.0	4.0V	3 Lead SOT-89
SPX2930M1-4.5	4.5V	3 Lead SOT-89
SPX2930M1-5.0	5.0V	3 Lead SOT-89
SPX2930U-3.0	3.0V	3 Lead TO-220
SPX2930U-3.3	3.3V	3 Lead TO-220
SPX2930U-3.5	3.5V	3 Lead TO-220
SPX2930U-4.0	4.0V	3 Lead TO-220
SPX2930U-4.5	4.5V	3 Lead TO-220
SPX2930U-5.0	5.0V	3 Lead TO-220



SIGNAL PROCESSING EXCELLENCE

Sipex Corporation

Headquarters and Main Offices:
22 Linnell Circle
Billerica, MA 01821
TEL: (978) 667-8700
FAX: (978) 670-9001
e-mail: sales@sipex.com

233 South Hillview Drive
Milpitas, CA 95035
TEL: (408) 935-7600
FAX: (408) 934-7500

Sipex Corporation reserves the right to make changes to any products described herein. Sipex does not assume any liability arising out of the application or use of any product or circuit described hereing; neither does it convey any license under its patent rights nor the rights of others.