

**“K” SERIES  
TWO PIECE  
CABLE TO “F” FEMALE  
ADAPTOR BULKHEAD**

Bulkhead connector capable of being secured in place for permanent mounting.

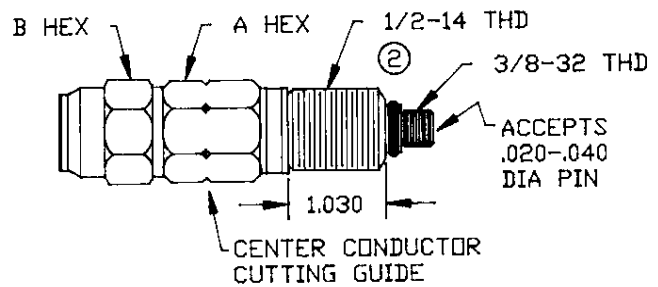
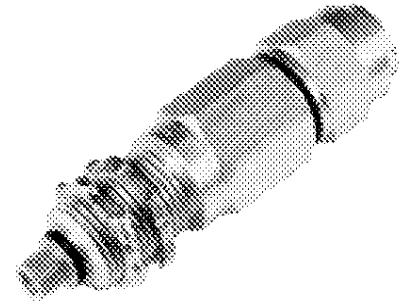

© Conduit Nuts Included

**Ordering Information — “F” Female Adaptor Bulkhead**

PART NUMBER	CABLE GROUP	CENTER COND.	CABLE O.D.	DIMENSION	
				A	B
BI412FFK	A	.080	.412	13/16	7/8
BI412FFK3	E,J	.092	.412	13/16	7/8
BI440FFMC2	I	.105	.450	1	1
BI500FFK	A	.100	.500	1	1
BI500FFK3	E,J	.109	.500	1	1
BI500FFMC2	I	.123	.510	1	1
BI500FFQR	H	.117	.580	1	1
BI540FFQR	H	.124	.610	1	1
BI565FFTX	G	.129	.565	1	1
BI625FFK3	E	.137	.625	1	1
BI650FFMC2	I	.156	.640	1-1/8	1-1/8
BI700FFTX	G	.163	.703	1-1/8	1-1/8
BI715FFQR	H	.166	.785	1-3/16	1-3/16
BI750FFK	A	.148	.750	1-1/8	1-1/8
BI750FFK3	E	.167	.750	1-1/8	1-1/8
BI750FFMC2	I	.185	.760	1-1/8	1-1/8
BI840FFTX	G	.194	.840	1-3/8	1-3/8
BI860FFQR	H	.203	.960	1-1/2	1-1/2
BI875FFK3	E	.194	.875	1-3/8	1-3/8
BI1000FFK3	E	.220	1.000	1-1/2	1-1/2
BI1000FFMC2	I	.248	1.015	1-1/2	1-1/2
BI1125FFQR	H	.263	1.225	1-3/4	1-3/4
BI1160FFTX	G	.269	1.160	1-3/4	1-3/4

\*See Cable Group Chart on Page 30 Patent #4,346,958

Dimensions shown are for reference only. Dimensions are in inches.

**“W” SERIES  
THREE PIECE  
CABLE TO “F” FEMALE  
ADAPTOR BULKHEAD**

Bulkhead connector capable of being secured in place for permanent mounting.

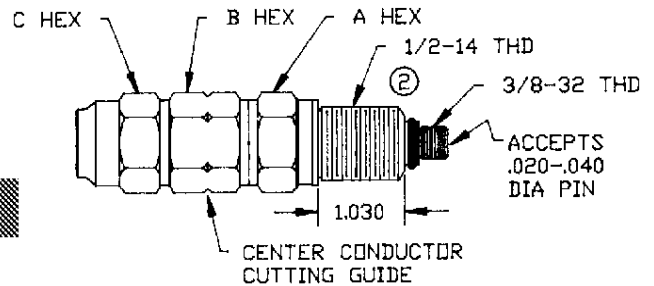
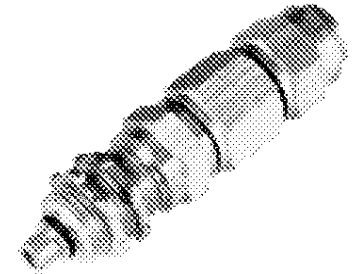

Ⓢ Conduit Nuts Included

**Ordering Information — “F” Female Adaptor Bulkhead**

PART NUMBER	CABLE GROUP	CENTER COND.	CABLE OD.	DIMENSION		
				A	B	C
BAI412FFW	A	.080	.412	15/16	15/16	15/16
BAI412FFW2	D	.092	.412	15/16	15/16	15/16
BAI412FFW3	E	.092	.412	15/16	15/16	15/16
BAI412FFSW	B	.092	.412	15/16	15/16	15/16
BAI440FFMC2	I	.105	.450	15/16	15/16	15/16
BAI500FFW	A	.100	.500	1	1	1
BAI500FFW2	D	.111	.500	1	1	1
BAI500FFW3	E	.109	.500	1	1	1
BAI500FFMC2	I	.123	.510	1	1	1
BAI500FFSW	B	.115	.500	1	1	1
BAI540FFQR	H	.124	.610	1-1/8	1-1/8	1-1/8
BAI565FFTX	G	.129	.565	1-1/8	1-1/8	1-1/8
BAI625FFW3	E	.137	.625	1-1/8	1-1/8	1-1/8
BAI650FFMC2	I	.156	.640	1-1/8	1-1/8	1-1/8
BAI700FFTX	G	.163	.703	1-3/16	1-3/16	1-3/16
BAI715FFQR	H	.166	.785	1-1/2	1-1/2	1-1/2
BAI750FFW	A	.148	.750	1-3/16	1-3/16	1-3/16
BAI750FFW2	D	.169	.750	1-3/16	1-3/16	1-3/16
BAI750FFW3	E	.167	.750	1-3/16	1-3/16	1-3/16
BAI750FFMC2	I	.185	.760	1-3/16	1-3/16	1-3/16
BAI750FFSW	B	.173	.750	1-3/16	1-3/16	1-3/16
BAI840FFTX	G	.194	.840	1-1/2	1-1/2	1-1/2
BAI860FFQR	H	.203	.960	1-1/2	1-1/2	1-1/2
BAI875FFW3	E	.194	.875	1-1/2	1-1/2	1-1/2
BAI1000FFW	A	.193	1.000	1-3/4	1-3/4	1-3/4
BAI1000FFW2	D	.225	1.000	1-3/4	1-3/4	1-3/4
BAI1000FFW3	E	.220	1.000	1-3/4	1-3/4	1-3/4
BAI1000FFMC2	I	.248	1.015	1-3/4	1-3/4	1-3/4
BAI1000FFSW	B	.227	1.000	1-3/4	1-3/4	1-3/4
BAI1125FFQR	H	.263	1.225	1-3/4	1-3/4	1-3/4

\*See Cable Group Chart on Page 30

Dimensions shown are for reference only. Dimensions are in inches.

**“K” SERIES  
TWO PIECE  
CABLE TO “F” FEMALE  
ADAPTORS**

Cable to “F” Female Adaptor with center conductor seizing mechanism and integral mandrel.

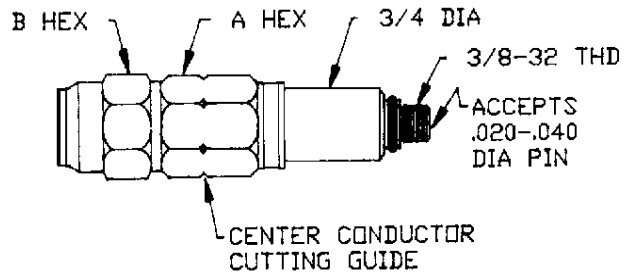
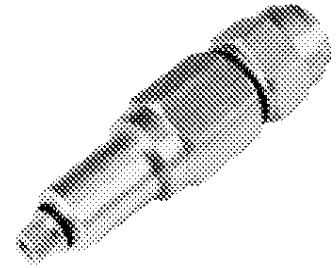

**Ordering Information — “F” Female Adaptor**

PART NUMBER	CABLE GROUP	CABLE CORD	CABLE O.D.	DIMENSION	
				A	B
AI412FFK	A	.080	.412	13/16	7/8
AI412FFK3	E,J	.092	.412	13/16	7/8
AI440FFMC2	I	.105	.450	1	1
AI500FFK	A	.100	.500	1	1
AI500FFK3	E,J	.109	.500	1	1
AI500FFMC2	I	.123	.510	1	1
AI500FFQR	H	.117	.580	1	1
AI540FFQR	H	.124	.610	1	1
AI565FFTX	G	.129	.565	1	1
AI625FFK3	E	.137	.625	1	1
AI650FFMC2	I	.156	.640	1-1/8	1-1/8
AI700FFTX	G	.163	.703	1-1/8	1-1/8
AI715FFQR	H	.166	.785	1-3/16	1-3/16
AI750FFK	A	.148	.750	1-1/8	1-1/8
AI750FFK3	E	.167	.750	1-1/8	1-1/8
AI750FFMC2	I	.185	.760	1-1/8	1-1/8
AI840FFTX	G	.194	.840	1-3/8	1-3/8
AI860FFQR	H	.203	.960	1-1/2	1-1/2
AI875FFK3	E	.194	.875	1-3/8	1-3/8
AI1000FFK3	E	.220	1.000	1-1/2	1-1/2
AI1000FFMC2	I	.248	1.015	1-1/2	1-1/2
AI1125FFQR	H	.263	1.225	1-3/4	1-3/4
AI1160FFTX	G	.269	1.160	1-3/4	1-3/4

\*See Cable Group Chart on page 30. Patent #4,346,958

Dimensions shown are for reference only. Dimensions are in inches.

**“W” SERIES  
THREE PIECE  
CABLE TO “F” FEMALE  
ADAPTORS**

Cable to “F” Female Adaptor with center conductor seizing mechanism and integral mandrel.

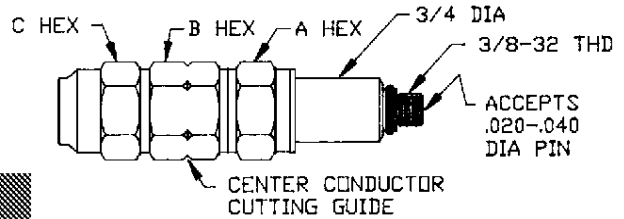
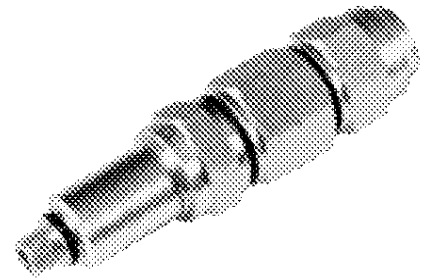

**Ordering Information — “F” Female Adaptor**

PART NUMBER	CABLE GROUP	CENTER COND. OD.	CABLE OD.	DIMENSION		
				A	B	C
AI412FFW	A	.080	.412	15/16	15/16	15/16
AI412FFW2	D	.092	.412	15/16	15/16	15/16
AI412FFW3	E	.092	.412	15/16	15/16	15/16
AI412FFSW	B	.092	.412	15/16	15/16	15/16
AI440FFWMC2	I	.105	.450	15/16	15/16	15/16
AI500FFW	A	.100	.500	1	1	1
AI500FFW2	D	.111	.500	1	1	1
AI500FFW3	E	.109	.500	1	1	1
AI500FFWMC2	I	.123	.510	1	1	1
AI500FFSW	B	.115	.500	1	1	1
AI540FFWQR	H	.124	.610	1-1/8	1-1/8	1-1/8
AI565FFWTX	G	.129	.565	1-1/8	1-1/8	1-1/8
AI625FFW3	E	.137	.625	1-1/8	1-1/8	1-1/8
AI650FFWMC2	I	.156	.640	1-1/8	1-1/8	1-1/8
AI700FFWTX	G	.163	.703	1-3/16	1-3/16	1-3/16
AI715FFWQR	H	.166	.785	1-1/2	1-1/2	1-1/2
AI750FFW	A	.148	.750	1-3/16	1-3/16	1-3/16
AI750FFW2	D	.169	.750	1-3/16	1-3/16	1-3/16
AI750FFW3	E	.167	.750	1-3/16	1-3/16	1-3/16
AI750FFWMC2	I	.185	.760	1-3/16	1-3/16	1-3/16
AI750FFSW	B	.173	.750	1-3/16	1-3/16	1-3/16
AI840FFWTX	G	.194	.840	1-1/2	1-1/2	1-1/2
AI860FFWQR	H	.203	.960	1-1/2	1-1/2	1-1/2
AI875FFW3	E	.194	.875	1-1/2	1-1/2	1-1/2
AI1000FFW	A	.193	1.000	1-3/4	1-3/4	1-3/4
AI1000FFW2	D	.225	1.000	1-3/4	1-3/4	1-3/4
AI1000FFW3	E	.220	1.000	1-3/4	1-3/4	1-3/4
AI1000FFWMC2	I	.248	1.015	1-3/4	1-3/4	1-3/4
AI1000FFSW	B	.227	1.000	1-3/4	1-3/4	1-3/4
AI1125FFWQR	H	.263	1.225	1-3/4	1-3/4	1-3/4

\*See Cable Group Chart on Page 30

Dimensions shown are for reference only. Dimensions are in inches.

**“K” SERIES  
TWO PIECE  
CABLE TO “F” MALE  
ADAPTORS**

Cable to “F” Male Adaptor with center conductor seizing mechanism and intgral mandrel.

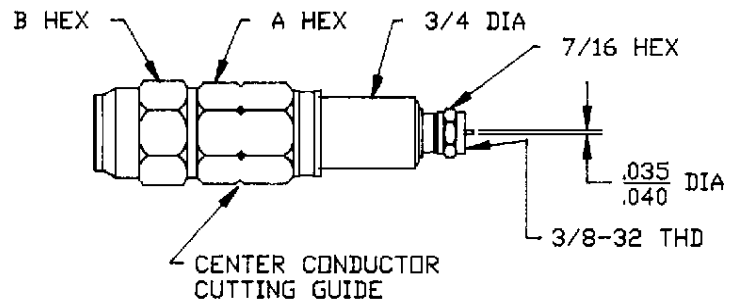
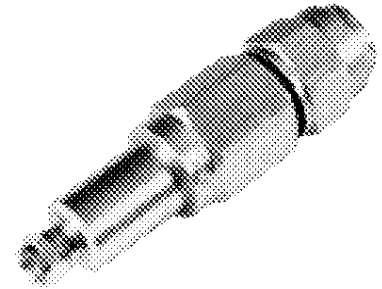

**Ordering Information — “F” Male Adaptor**

PART NUMBER	CABLE GROUP	CENTER COND.	CABLE O.D.	DIMENSION	
				A	B
AI412FMK	A	.080	.412	13/16	7/8
AI412FMK3	E,J	.092	.412	13/16	7/8
AI440FMMC2	I	.105	.450	1	1
AI500FMK	A	.100	.500	1	1
AI500FMK3	E,J	.109	.500	1	1
AI500FMMC2	I	.123	.510	1	1
AI500FMQR	H	.117	.580	1	1
AI540FMQR	H	.124	.610	1	1
AI565FMTX	G	.129	.565	1	1
AI625FMK3	E	.137	.625	1	1
AI650FMMC2	I	.156	.640	1-1/8	1-1/8
AI700FMTX	G	.163	.703	1-1/8	1-1/8
AI715FMQR	H	.166	.785	1-3/16	1-3/16
AI750FMK	A	.148	.750	1-1/8	1-1/8
AI750FMK3	E	.167	.750	1-1/8	1-1/8
AI750FMMC2	I	.185	.760	1-1/8	1-1/8
AI840FMTX	G	.194	.840	1-3/8	1-3/8
AI860FMQR	H	.203	.960	1-1/2	1-1/2
AI875FMK3	E	.194	.875	1-3/8	1-3/8
AI1000FMK3	E	.220	1.000	1-1/2	1-1/2
AI1000FMMC2	I	.248	1.015	1-1/2	1-1/2
AI1125FMQR	H	.263	1.225	1-3/4	1-3/4
AI1160FMTX	G	.269	1.160	1-3/4	1-3/4

\*See Cable Group Chart on Page 30. Patent #4,346,958

Dimensions shown are for reference only. Dimensions are in inches.

**"W" SERIES  
THREE PIECE CABLE TO  
"F" MALE ADAPTORS**

Cable to "F" Male Adaptor with center conductor seizing mechanism and integral mandrel.

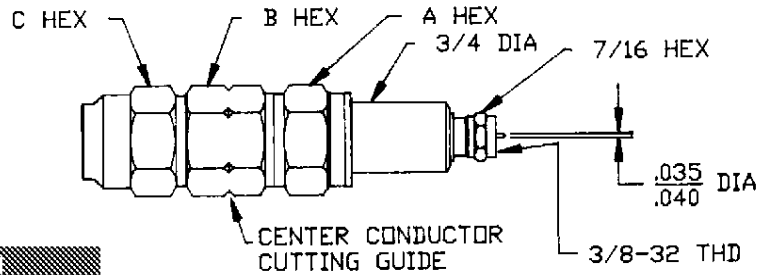
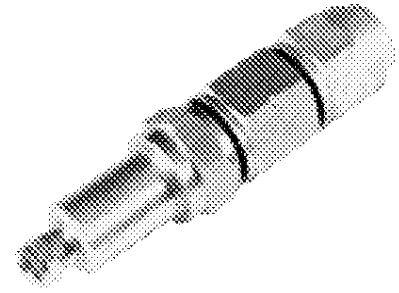

**Ordering Information — "F" Male Adaptor**

PART NUMBER	CABLE GROUP	CENTER COND.	CABLE O.D.	DIMENSION		
				A	B	C
AI412FMW	A	.080	.412	15/16	15/16	15/16
AI412FMW2	D	.092	.412	15/16	15/16	15/16
AI412FMW3	E	.092	.412	15/16	15/16	15/16
AI440FMWMC2	I	.105	.450	15/16	15/16	15/16
AI412FMSW	B	.092	.412	15/16	15/16	15/16
AI500FMW	A	.100	.500	1	1	1
AI500FMW2	D	.111	.500	1	1	1
AI500FMW3	E	.109	.500	1	1	1
AI500FMWMC2	I	.123	.510	1	1	1
AI500FMSW	B	.115	.500	1	1	1
AI540FMWQR	H	.124	.610	1-1/8	1-1/8	1-1/8
AI565FMWTX	G	.129	.565	1-1/8	1-1/8	1-1/8
AI625FMW3	E	.137	.625	1-1/8	1-1/8	1-1/8
AI650FMWMC2	I	.156	.640	1-1/8	1-1/8	1-1/8
AI700FMWTX	G	.163	.703	1-3/16	1-3/16	1-3/16
AI715FMWQR	H	.166	.785	1-1/2	1-1/2	1-1/2
AI750FMW	A	.148	.750	1-3/16	1-3/16	1-3/16
AI750FMW2	D	.169	.750	1-3/16	1-3/16	1-3/16
AI750FMW3	E	.167	.750	1-3/16	1-3/16	1-3/16
AI750FMWMC2	I	.185	.760	1-3/16	1-3/16	1-3/16
AI750FMSW	B	.173	.750	1-3/16	1-3/16	1-3/16
AI840FMWTX	G	.194	.840	1-1/2	1-1/2	1-1/2
AI860FMWQR	H	.203	.960	1-1/2	1-1/2	1-1/2
AI875FMW3	E	.194	.875	1-1/2	1-1/2	1-1/2
AI1000FMW	A	.193	1.000	1-3/4	1-3/4	1-3/4
AI1000FMW2	D	.225	1.000	1-3/4	1-3/4	1-3/4
AI1000FMW3	E	.220	1.000	1-3/4	1-3/4	1-3/4
AI1000FMWMC2	I	.248	1.015	1-3/4	1-3/4	1-3/4
AI1000FMSW	B	.227	1.000	1-3/4	1-3/4	1-3/4
AI1125FMWQR	H	.263	1.225	1-3/4	1-3/4	1-3/4

\* See Cable Group Chart on Page 30

Dimensions shown are for reference only. Dimensions are in inches.