



TO-5 CASE RELAY SENSITIVE SPDT

Series
1MS

• Basic • Suppression • Suppression/Steering • Transistor Driven

Product Description

A series of ultra miniature hermetically sealed relays constructed in a transistor style case, providing superior performance and established reliability characteristics. Available in a variety of sensitivities contact configurations and hybrid improvement, to provide a most versatile element to the circuit designer.

The following construction features ensure the highest reliability in extreme environments:

- All welded relay construction
- Cleaning and sealing techniques ensures maximum internal cleanliness
- Low level to 1 ampere switching
- 1 form C, SPDT contacts, special metal alloy with gold plating
- Frame design and force / mass ratio provides exceptional shock and vibration immunity

Low intercontact capacitance and contact circuit losses, provides also a reliable switching functions in demanding RF applications, combined with small size and low coil power dissipation (see figure 1).

Series Types (note 1)

- **1MS*** Basic Relay, 1 form C, SPDT
- **1MS*D** Basic Relay combined with an internal diode for coil transient suppression
- **1MS*DD** Basic Relay incorporates two internal diodes for coil transient suppression and polarity reversal protection
- **1MS*T** Basic Relay incorporating an internal transistor driver and diode for coil transient suppression

Environmental and Physical Specifications

Temperature (Ambient)	- 65°C to + 125°C
Shock	75 g, 6 ms.
Vibration (sinusoidal)	30 g, 10 to 3000 Hz
Vibration (random)	0,4 g ² / Hz, 50 to 2000 Hz
Acceleration	50 g
Sealing	All welded, Hermetic
Weight	0,10 oz. (2,84 grams) max.

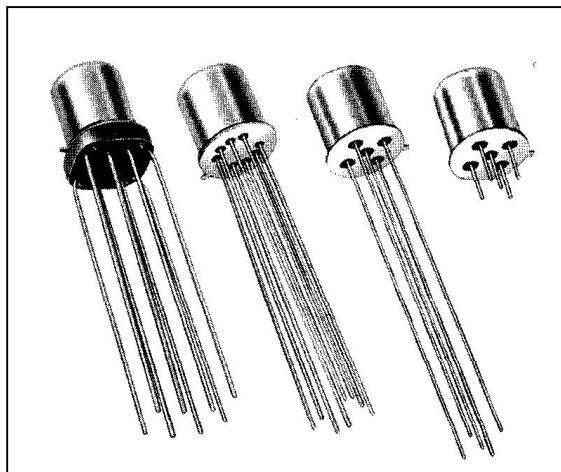

Electrical Characteristics (over the Temperature range. Unless otherwise noted)

Coil Data	See Typical Characteristics chart		
Contact Rating	Type Load	Contact Load	Cycles min.
(Note: All ratings with grounded case)	Low Level	10 to 50 μ A / 10 to 50 mV	1.000.000
	Resistive	1 A / 28 Vdc 250 mA / 115Vac, 60 and 400 Hz (Case not grounded)	100.000 100.000
	Resistive overload	100 mA / 115 Vac, 60 and 400 Hz	100.000
	Inductive	2 A / 28 Vdc 200 mA / 28 Vdc (320 mH)	100 100.000
	Lamp	100 mA / 28 Vdc	100.000
Contact Resistance	0,1 Ω max. initial, 0,2 Ω max. after life		
Operate Time	4,0 ms. max. Series: 1MS*, 1MS*D, 1MS*DD		3,5 ms. max. Series: 1MS*T
Release Time	2,5 ms. max. Series: 1MS*		7,5 ms. max. Series: 1MS*D, 1MS*DD, 1MS*T
Contact Bounce	1,5 ms. max.		
Dielectric Strength	500 Vrms min., 60 Hz, all points at sea level		300 Vrms min., 60 Hz, all points at 70.000 ft.
Insulation Resistance	10.000 M Ω min. all points at 500 Vdc		
Intercontact Capacitance	0,7 pF typical		
Sensitivity	40 mW at pick-up, 200 mW at nominal rated coil voltage, at 25 °C		
Diode P.I.V.	100 Vdc min. Series: 1MS*D, 1MS*DD, 1MS*T		
Negative Coil Transient	1,0 Vdc max. Series: 1MS*D, 1MS*DD, 1MS*T		
Transistor Characteristics at 25 °C (Series 1MS*T)	Emitter-Base Voltage (Vebo)		6,0 Vdc min.
	Collector-Base Breakdown Voltage (Vcbo) (Ic = 10 μ A)		70 Vdc min.
	Base Turn-Off Voltage		0,3 Vdc max.

Figure 1 - Radio Frequency Curves

Note:
Radio frequency curves are typical characteristics based on factory knowledge. Tests to ensure compliance on RF performance, are not performed.

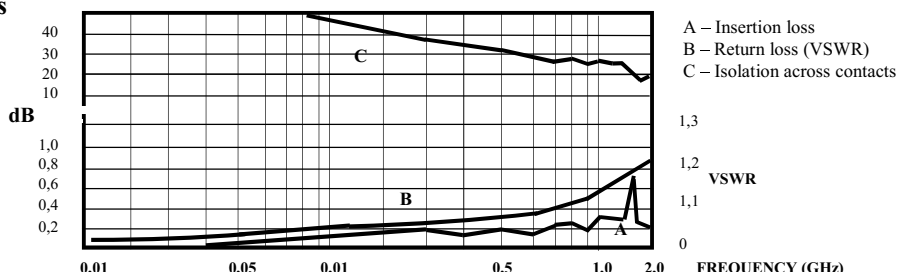



TO-5 CASE RELAY SENSITIVE SPDT

Series
1MS

• Basic • Suppression • Suppression/Steering • Transistor Driven

Typical Characteristics

Description	Meas.	Series Types		Coil Voltage Code								
				5	6	9	12	18	26	32	40	
Coil Voltage	Vdc	1MS*, 1MS*D, 1MS*DD, 1MS*T	Nom.	5,0	6,0	9,0	12,0	18,0	26,5	32,0	40,0	
		1MS*, 1MS*D, 1MS*DD, 1MS*T	Max.	8,0	11,0	12,0	22,0	24,0	45,0	57,0	75,0	
Coil Resistance at 25°C	Ω	1MS*, 1MS*D, 1MS*T	± 10%	125	255	630	1025	2300	4000	6500	11000	
		1MS*DD		100	200							
Coil Current at 25°C	mAdc	1MS*DD	Min.	36,3	22,7	11,5	9,7	6,7	5,7	4,3	3,2	
			Max.	50,0	30,6	15,0	12,5	8,5	7,2	5,4	4,0	
		1MS*T	Min.	34,7	21,2	11,8	10,1	6,7	5,7	4,2	3,1	
			Max.	47,8	27,7	16,8	13,6	9,1	7,7	5,8	4,3	
Pick-up Voltage at 25°C	Vdc	1MS*, 1MS*D	Typ.	2,8	3,5	5,3	7,0	10,5	14,2	18,7	23,3	
		1MS*DD	Typ.	3,5	4,1	6,3	8,0	11,6	15,4	17,0	22,0	
		1MS*T	Typ.	2,6	3,5	5,4	6,6	9,8	12,8	18,7	23,3	
Drop-Out Voltage at 25°C	Vdc	1MS*, 1MS*D, 1MS*T	Min.	0,22	0,28	0,54	0,63	0,91	1,37	1,60	2,10	
			Max.	1,7	2,0	3,0	4,0	6,0	8,0	10,6	13,3	
		1MS*DD	Min.	0,23	0,28	0,54	0,63	0,91	1,37	1,5	2,0	
			Max.	1,7	2,0	3,0	4,0	6,0	8,0	9,0	11,2	
Base Current to Turn-on	mAdc	1MS*T (limit for base / emitter current to 15 mA max.)	Min.	1,2	0,78	0,48	0,39	0,26	0,20	0,16	0,13	

Outline Dimensions

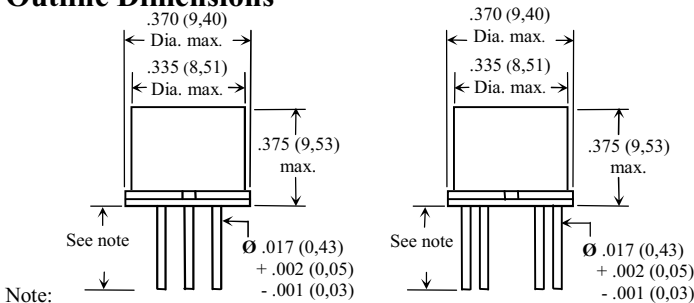

Note:
 - Dimensions are shown in inches (millimetres)
 - Terminal Variants: - (C) Standard Wire Terminal = .500 (12,7) min.,
 - (W) Long Wire Terminal = 1.500 (38,1) min.,
 - (P) Pin Terminal = .187 ± .010 (4,75 ± 0,25)

Terminal Locations

Basic and Suppressed Transistor Driven

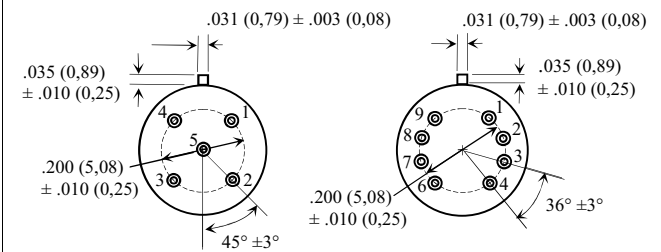

Note:
 - Dimensions are shown in inches (millimetres)
 - Viewed from terminals, numbers are for reference only

Schematic Diagrams

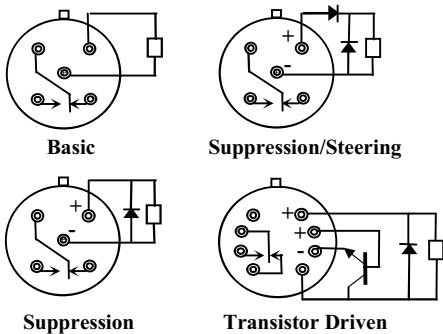

Note: Schematics are viewed from terminals

Spreader Pads

Relays can be supplied with a spreader pad epoxied to the relay header, to prevent the possible shorting of printed circuit board land lines and to facilitate circuit board cleaning. To order relay with pad add. "S" or "S2" to Part Number, Example: **1MSWD - 26S**

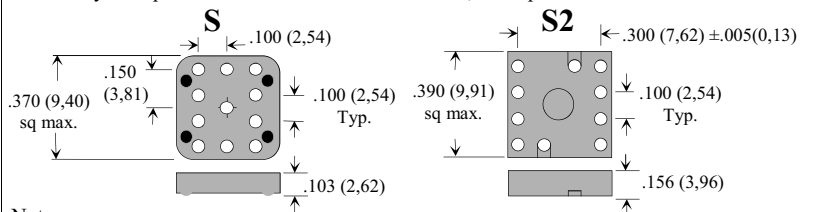

Note:
 - Dimensions are in inches (millimetres)
 - Pad Type S2 is used only on series 1MS*T
 - Pad Type S is used on series: 1MS*, 1MS*D, 1MS*DD, 1MS*T

Note:

1 "*" Indicates Terminal Variants: C, P or W

2 Tr ON: $I_b = 0,13$ to $1,2$ mA,
 Tr OFF: $V_B = 0,3$ Vdc max.

$$3 \quad R_B = \frac{V_B - 0,7}{I_{Bsat}} \quad I_{Bsat} = \frac{V_{coil} - 0,4}{5R_{coil}}$$

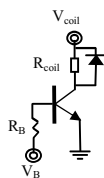

How to Order, (Part Numbering System)

