

Square body flush end contact — 1000V (IEC): 50–1400A

1000V (IEC) 50–1400A

Specifications

Description: Square body flush end contact high speed fuses.

Dimensions: See dimensions illustration.

Ratings:

Volts: — 1000Vac.

Amps: — 50-1400A

IR: — 150kA (Est.300kA) RMS Sym.

Agency Information: CE, Designed and tested to IEC 60269: Part 4, UL Recognized.

Electrical Characteristics

Total clearing I²t

The total clearing I²t at rated voltage and at power factor of 15% are given in the electrical characteristics. For other voltages, the clearing I²t is found by multiplying by correction factor, K, given as a function of applied working voltage, E_G, (rms).

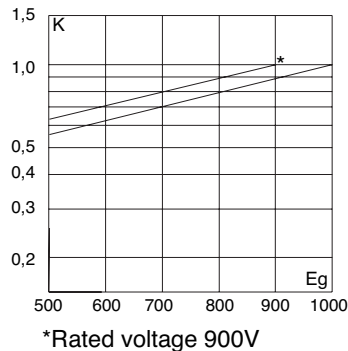

Arc Voltage

This curve gives the peak arc voltage, U_L, which may appear across the fuse during its operation as a function of the applied working voltage E_G, (rms) at a power factor of 15%.

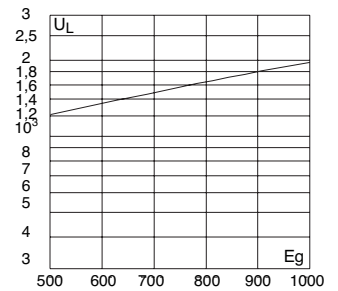

Power Losses

Watts loss at rated current is given in the electrical characteristics. The curve allows the calculation of the power losses at load currents lower than the rated current. The correction factor, K_p, is given as a function of the RMS load current, I_b, in % of the rated current.

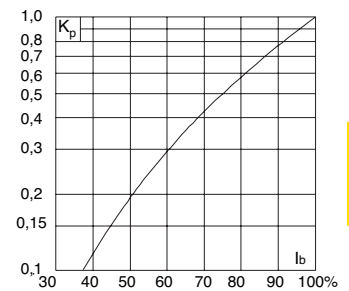

Features and Benefits

- Excellent dc performance
- Low arc voltage and low energy let-through (I²t)
- Low watts loss
- Superior cycling capability

Typical Applications

- DC common bus
- DC drives
- Power converters/rectifiers
- Reduced voltage starters

Dimensions (mm)

Type –BKN/- and –GKN/-

Size	Size	A	B	Max D	E	F	F** (in)	Min G	H
1*	BKN/75+GKN/75	72.5	74	61	43	M8	5/16" – 18 UNC-2B	5	ø17.5
1	BKN/75+GKN/75	73.2	74	69	52	M8	5/16" – 18 UNC-2B	8	ø20
2	BKN/75+GKN/75	73.2	74.4	77	59	M10	3/8" – 16 UNC-2B	10	ø24
3	BKN/75+GKN/75	73.3	75.4	92	74	M12	1/2" – 13 UNC-2B	10	ø30
3	BKN/90+GKN/90	80.3	91.4	92	74	M12	1/2" – 13 UNC-2B	10	ø30

** Valid for fuses type –GKN/-.

1mm = 0.0394" / 1" = 25.4mm

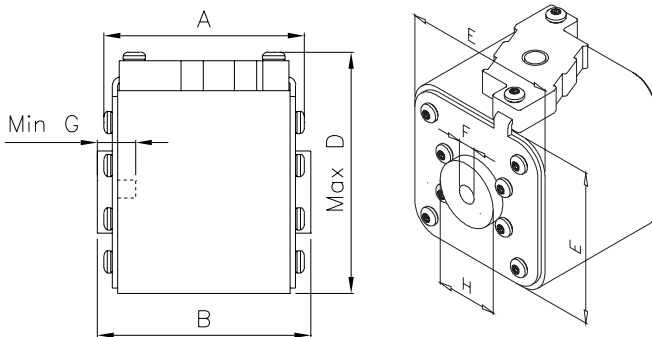

High Speed Fuses

High Speed Fuses

Square body flush end contact — 1000V (IEC): 50–1400A

Catalog Numbers

Catalog Numbers		Electrical Characteristics					
-BKN/ Type K Indicator for Micro	-GKN/ Type K Indicator for Micro	Size	Rated Voltage	Rated Current RMS-Amps	I ² t (A ² Sec)		Watts Loss
					Pre-arc	Clearing at Rated Voltage	
170M3951	170M3921	1*	1000	50	135	815	20
170M3952	170M3922		1000	63	215	1300	25
170M3953	170M3923		1000	80	460	2750	30
170M3954	170M3924		1000	100	860	5100	35
170M3955	170M3925		1000	125	1450	8600	40
170M3956	170M3926		1000	160	2850	17500	45
170M3957	170M3927		1000	200	4950	29500	48
170M3958	170M3928		1000	250	9550	57000	50
170M3959	170M3929		1000	315	21500	130000	60
170M3960	170M3930		1000	350	29000	175000	65
170M3961	170M3931	1000	400	42000	250000	70	
170M4951	170M4921	1	1000	160	2200	13500	40
170M4952	170M4922		1000	200	4150	24500	45
170M4953	170M4923		1000	250	7750	46000	52
170M4954	170M4924		1000	315	16500	98500	60
170M4955	170M4925		1000	350	21500	130000	65
170M4956	170M4926		1000	400	31000	185000	70
170M4957	170M4927		1000	450	44500	265000	80
170M4958	170M4928		1000	500	63000	375000	85
170M4959	170M4929		1000	550	84500	500000	90
170M4960	170M4930		1000	630	125000	755000	98
170M5952	170M5922	2	1000	250	6750	40000	65
170M5953	170M5923		1000	315	13500	81500	75
170M5954	170M5924		1000	350	16500	99000	80
170M5955	170M5925		1000	400	26000	155000	85
170M5956	170M5926		1000	450	35500	210000	90
170M5957	170M5927		1000	500	49500	295000	95
170M5958	170M5928		1000	550	66000	390000	100
170M5959	170M5929		1000	630	93500	555000	110
170M5960	170M5930		1000	700	130000	770000	115
170M5961	170M5931		1000	800	195000	1200000	125
170M8600	170M8500	3	1000	315	9200	54500	90
170M8601	170M8501		1000	350	13000	77500	95
170M8602	170M8502		1000	400	19000	115000	105
170M8603	170M8503		1000	450	27000	160000	107
170M8604	170M8504		1000	500	37500	225000	110
170M8605	170M8505		1000	550	52000	310000	115
170M8606	170M8506		1000	630	82500	490000	120
170M8607	170M8507		1000	700	115000	700000	125
170M8608	170M8508		1000	800	170000	1050000	135
170M8609	170M8509		1000	900	250000	1500000	145
170M8610	170M8510		1000	1000	340000	2050000	150
170M8611	170M8511		1000	1100	460000	2750000	155
170M8612**	170M8512**		1000	1250	575000	3400000	175
170M8613**	170M8513**		900	1400	795000	4200000	185

**Overall length is 90mm, for all other fuses the overall length is 75mm.

• Watts loss provided at rated current.

• Microswitch ordered separately. See accessories on page 179-180.

Square body flush end contact — 1000V (IEC): 50–1400A

Size 1* — 50-400A: 1000V
Time-Current Curve

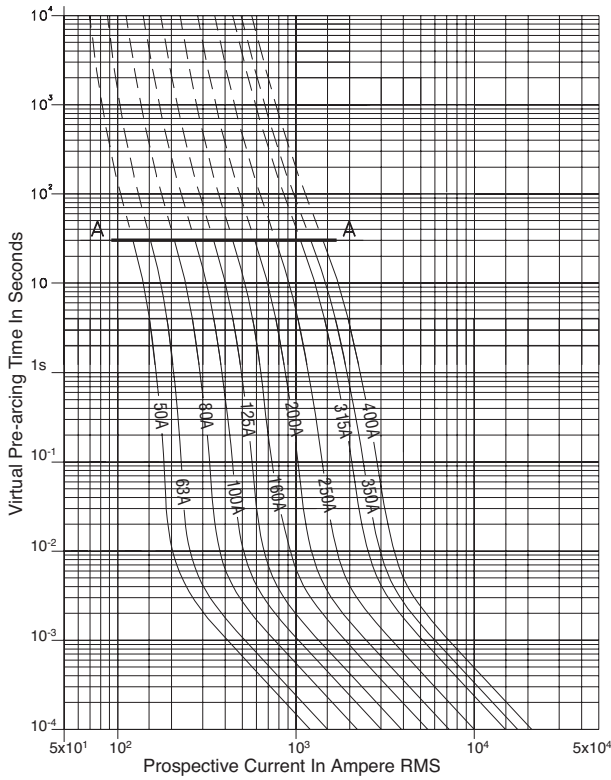

Size 1 — 160-630A: 1000V
Time-Current Curve

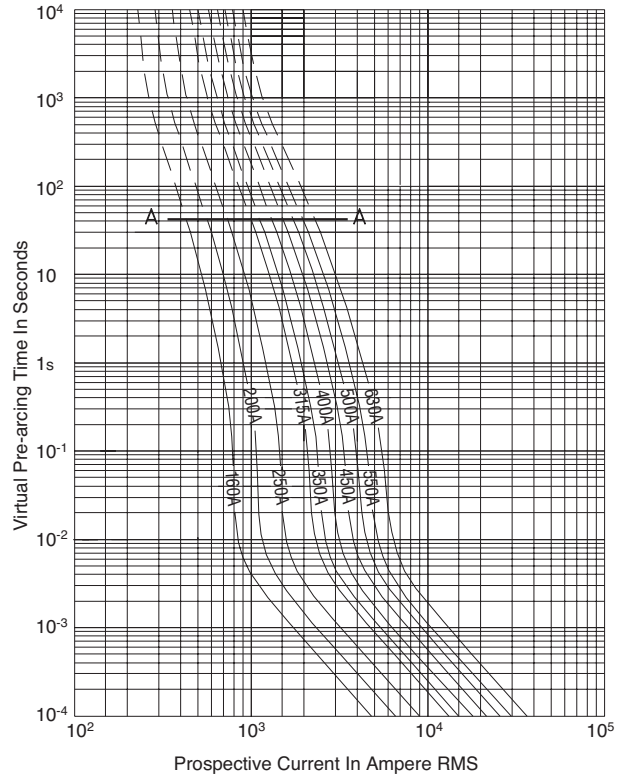

High Speed
Fuses

Peak Let-Through Curve

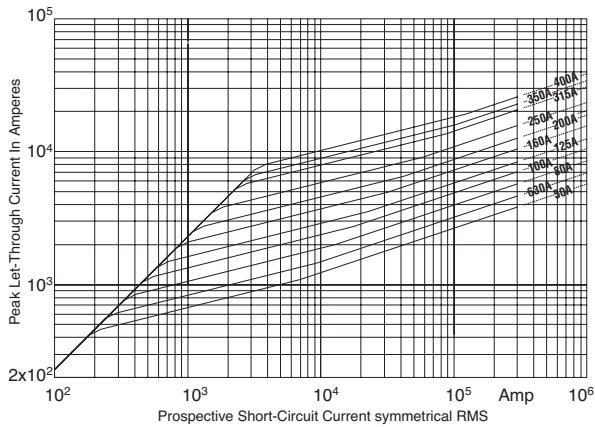

Peak Let-Through Curve

