

2.54mm Pitch

SERIES

9067

ミニビット
MINI-BIT

リセプタクル (RECEPTACLE)

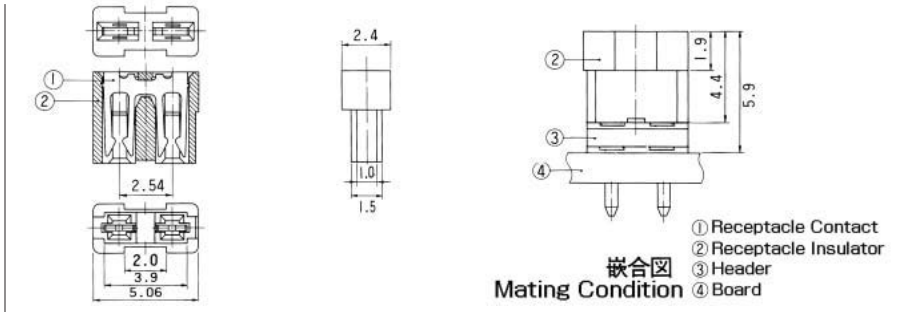

注文コード/Ordering Code

Part No. 00 9067 020 000 XXX

メッキコード (Finish Code)

805 : すずメッキ2.0μm以上
(Tin 2.0μm Min.)

807 : ニッケル下地
接点部金メッキ0.1μm以上
(Mating Area Gold Balance bare nickel)

ヘッダー (Header)

1列 (Single Row)

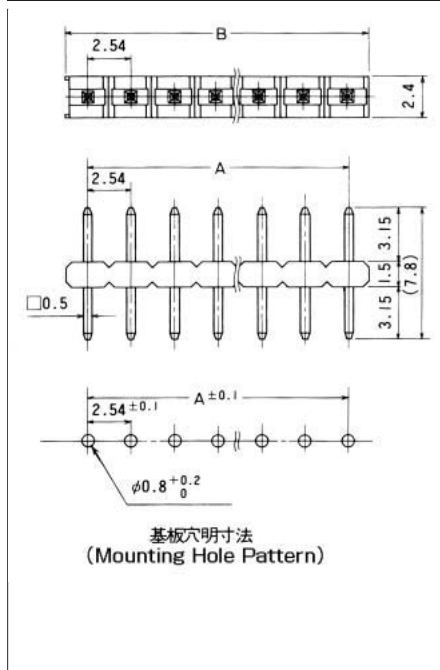

2列 (Dual Rows)

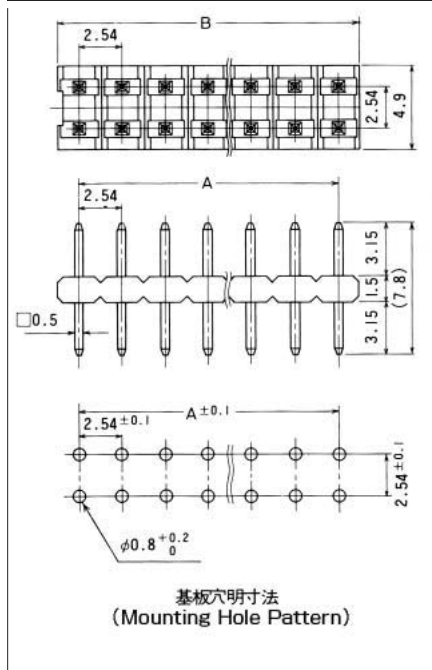

3列 (Triple Rows)

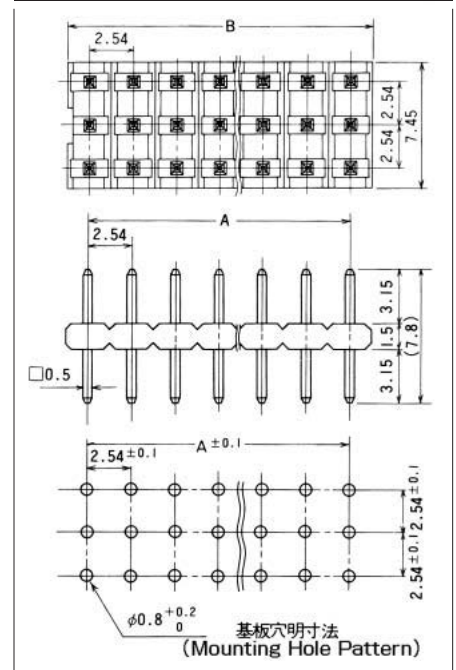

注文コード/Ordering Code

No. of Contacts	Part No.	A	B
1	00 9067 011 000 ***	—	2.54
4	00 9067 041 000 ***	7.62	10.16
5	00 9067 051 000 ***	10.16	12.70
6	00 9067 061 000 ***	12.70	15.24
7	00 9067 071 000 ***	15.24	17.78
8	00 9067 081 000 ***	17.78	20.32
9	00 9067 091 000 ***	20.32	22.86
10	00 9067 101 000 ***	22.86	25.40

注文コード/Ordering Code

No. of Contacts	Part No.	A	B
2	00 9067 022 000 ***	—	2.54
4	00 9067 042 000 ***	2.54	5.08
6	00 9067 062 000 ***	5.08	7.62
8	00 9067 082 000 ***	7.62	10.16
10	00 9067 102 000 ***	10.16	12.70
12	00 9067 122 000 ***	12.70	15.24
14	00 9067 142 000 ***	15.24	17.78
16	00 9067 162 000 ***	17.78	20.32
18	00 9067 182 000 ***	20.32	22.86
20	00 9067 202 000 ***	22.86	25.40

注文コード/Ordering Code

No. of Contacts	Part No.	A	B
3	00 9067 033 000 ***	—	2.54
6	00 9067 063 000 ***	2.54	5.08
9	00 9067 093 000 ***	5.08	7.62
12	00 9067 123 000 ***	7.62	10.16
15	00 9067 153 000 ***	10.16	12.70
18	00 9067 183 000 ***	12.70	15.24
21	00 9067 213 000 ***	15.24	17.78
24	00 9067 243 000 ***	17.78	20.32
27	00 9067 273 000 ***	20.32	22.86
30	00 9067 303 000 ***	22.86	25.40

●1列の2極は2列の2極を、1列の3極は3列の3極をご使用ください。
In the request of 1 row type header with 2 positions and 3 positions, please use 2 rows type header with 2 positions and 3 rows type header with 3 positions respectively.

●1000個単位でご注文ください。
Order unit is 1,000 pieces.

***メッキコード (Finish Code)

801 : すずメッキ2.0μm以上 (Tin 2.0μm Min.)
806 : ニッケル下地 (Ni Under Coated)
金メッキ0.1μm以上 (Gold 0.1μm Min.)

2.54mm Pitch

SERIES

9067

ミニビット
MINI-BIT

リセプタクル (RECEPTACLE)

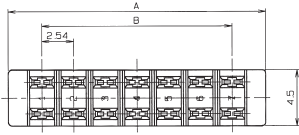

種数 NO. OF POS.	A	B	C
10	15.56	10.16	14.16
14	20.64	15.24	19.24

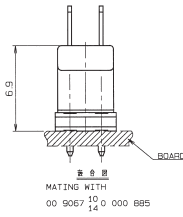
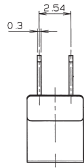
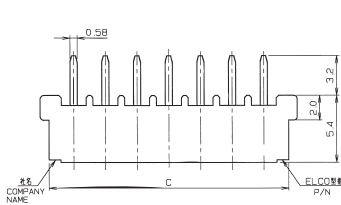
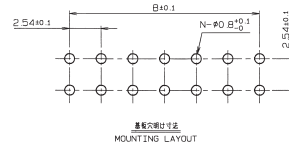

注文コード/Ordering Code

Part No. **00 9067 xx0 000 xxx**

メッキコード
(Finish Code)

885 : ニッケル下地

接続部Auメッキ

テール部 半円メッキ

(Ni Under Coated)
(Au Mating Area)

(Tail= Tin-lead)

極数 (No. of Contacts)

10:10P

14:14P