

SMDインダクタ

SURFACE MOUNT HIGH CURRENT INDUCTOR



OPERATING TEMP	04, 05, 06タイプ	-25~+105°C	(製品自己発熱を含む)
	08タイプ	-25~+85°C	(Including self-generated heat)

特長 FEATURES

- ・省スペース及び低背化
- ・大電流対応
- ・SMT対応

- ・ Small surface area and low profile.
- ・ Designed for high current applications where a surface mount component is required.
- ・ Available in embossed tape and reel.

用途 APPLICATIONS

- ・ カーナビゲーション、デジタルビデオカメラ、ノート型パソコンなど各種機器の電源回路、DC/DCコンバータ等

Power supply circuits/DC-DC converters in a variety of applications where compact size is vital, such as digital camcorders, car navigation systems, notebook PCs, etc.

形名表記法 ORDERING CODE

<p>1</p> <table border="1"> <tr><th colspan="2">形式</th></tr> <tr><td>N△</td><td>チョークコイル(非シールドタイプ)</td></tr> <tr><td>N P</td><td>チョークコイル(シールドタイプ)</td></tr> <tr><td>N H</td><td>チョークコイル(シールドタイプ)</td></tr> </table> <p>△=スペース</p>	形式		N△	チョークコイル(非シールドタイプ)	N P	チョークコイル(シールドタイプ)	N H	チョークコイル(シールドタイプ)	<p>3</p> <table border="1"> <tr><th colspan="2">形状</th></tr> <tr><td>D P</td><td>ドラム形(台座付き)</td></tr> <tr><td>D△</td><td>ドラム形(台座なし)</td></tr> <tr><td>S△, SZ</td><td>ドラム応用形</td></tr> </table> <p>△=スペース</p>	形状		D P	ドラム形(台座付き)	D△	ドラム形(台座なし)	S△, SZ	ドラム応用形	<p>5</p> <table border="1"> <tr><th colspan="2">公称インダクタンス[μH]</th></tr> <tr><td>例</td><td></td></tr> <tr><td>1R0</td><td>1.0</td></tr> <tr><td>100</td><td>10</td></tr> <tr><td>102</td><td>1000</td></tr> </table> <p>※R=小数点</p>	公称インダクタンス[μH]		例		1R0	1.0	100	10	102	1000	<p>7</p> <table border="1"> <tr><th colspan="2">当社管理記号</th></tr> <tr><td>△△</td><td>標準品</td></tr> </table> <p>△=スペース</p>	当社管理記号		△△	標準品										
形式																																											
N△	チョークコイル(非シールドタイプ)																																										
N P	チョークコイル(シールドタイプ)																																										
N H	チョークコイル(シールドタイプ)																																										
形状																																											
D P	ドラム形(台座付き)																																										
D△	ドラム形(台座なし)																																										
S△, SZ	ドラム応用形																																										
公称インダクタンス[μH]																																											
例																																											
1R0	1.0																																										
100	10																																										
102	1000																																										
当社管理記号																																											
△△	標準品																																										
<p>2</p> <table border="1"> <tr><th colspan="2">コア寸法(mm)</th></tr> <tr><td>04</td><td>4.7</td></tr> <tr><td>05</td><td>5.6</td></tr> <tr><td>06</td><td>6.8</td></tr> <tr><td>08</td><td>9.0</td></tr> </table>	コア寸法(mm)		04	4.7	05	5.6	06	6.8	08	9.0	<p>4</p> <table border="1"> <tr><th colspan="5">高さ寸法(mm)</th></tr> <tr><th></th><th>04タイプ</th><th>05タイプ</th><th>06タイプ</th><th>08タイプ</th></tr> <tr><td>A</td><td>3.0max.</td><td>—</td><td>—</td><td>6.0max.</td></tr> <tr><td>B</td><td>2.0max.</td><td>2.8max.</td><td>3.2max.</td><td>5.0max.</td></tr> </table>	高さ寸法(mm)						04タイプ	05タイプ	06タイプ	08タイプ	A	3.0max.	—	—	6.0max.	B	2.0max.	2.8max.	3.2max.	5.0max.	<p>6</p> <table border="1"> <tr><th colspan="2">インダクタンス許容差</th></tr> <tr><td>J</td><td>±5%</td></tr> <tr><td>K</td><td>±10%</td></tr> <tr><td>M</td><td>±20%</td></tr> <tr><td>N</td><td>±30%</td></tr> </table>	インダクタンス許容差		J	±5%	K	±10%	M	±20%	N	±30%	
コア寸法(mm)																																											
04	4.7																																										
05	5.6																																										
06	6.8																																										
08	9.0																																										
高さ寸法(mm)																																											
	04タイプ	05タイプ	06タイプ	08タイプ																																							
A	3.0max.	—	—	6.0max.																																							
B	2.0max.	2.8max.	3.2max.	5.0max.																																							
インダクタンス許容差																																											
J	±5%																																										
K	±10%																																										
M	±20%																																										
N	±30%																																										



<p>1</p> <table border="1"> <tr><th colspan="2">Type</th></tr> <tr><td>N△</td><td>Choke coil (non-shielded type)</td></tr> <tr><td>N P</td><td>Choke coil (shielded type)</td></tr> <tr><td>N H</td><td>Choke coil (shielded type)</td></tr> </table> <p>△=Blank space</p>	Type		N△	Choke coil (non-shielded type)	N P	Choke coil (shielded type)	N H	Choke coil (shielded type)	<p>3</p> <table border="1"> <tr><th colspan="2">Shape</th></tr> <tr><td>D P</td><td>Drum type (With base)</td></tr> <tr><td>D△</td><td>Drum type (Without base)</td></tr> <tr><td>S△, SZ</td><td>Applied drum type</td></tr> </table> <p>△=Blank space</p>	Shape		D P	Drum type (With base)	D△	Drum type (Without base)	S△, SZ	Applied drum type	<p>5</p> <table border="1"> <tr><th colspan="2">Nominal inductance[μH]</th></tr> <tr><td>example</td><td></td></tr> <tr><td>1R0</td><td>1.0</td></tr> <tr><td>100</td><td>10</td></tr> <tr><td>102</td><td>1000</td></tr> </table> <p>※R=Decimal point</p>	Nominal inductance[μH]		example		1R0	1.0	100	10	102	1000	<p>7</p> <table border="1"> <tr><th colspan="2">Internal code</th></tr> <tr><td>△△</td><td>Standard product</td></tr> </table> <p>△=Blank space</p>	Internal code		△△	Standard product										
Type																																											
N△	Choke coil (non-shielded type)																																										
N P	Choke coil (shielded type)																																										
N H	Choke coil (shielded type)																																										
Shape																																											
D P	Drum type (With base)																																										
D△	Drum type (Without base)																																										
S△, SZ	Applied drum type																																										
Nominal inductance[μH]																																											
example																																											
1R0	1.0																																										
100	10																																										
102	1000																																										
Internal code																																											
△△	Standard product																																										
<p>2</p> <table border="1"> <tr><th colspan="2">Core dimension(mm)</th></tr> <tr><td>04</td><td>4.7</td></tr> <tr><td>05</td><td>5.6</td></tr> <tr><td>06</td><td>6.8</td></tr> <tr><td>08</td><td>9.0</td></tr> </table>	Core dimension(mm)		04	4.7	05	5.6	06	6.8	08	9.0	<p>4</p> <table border="1"> <tr><th colspan="5">Height(mm)</th></tr> <tr><th></th><th>04 type</th><th>05 type</th><th>06 type</th><th>08 type</th></tr> <tr><td>A</td><td>3.0max.</td><td>—</td><td>—</td><td>6.0max.</td></tr> <tr><td>B</td><td>2.0max.</td><td>2.8max.</td><td>3.2max.</td><td>5.0max.</td></tr> </table>	Height(mm)						04 type	05 type	06 type	08 type	A	3.0max.	—	—	6.0max.	B	2.0max.	2.8max.	3.2max.	5.0max.	<p>6</p> <table border="1"> <tr><th colspan="2">Inductance tolerance</th></tr> <tr><td>J</td><td>±5%</td></tr> <tr><td>K</td><td>±10%</td></tr> <tr><td>M</td><td>±20%</td></tr> <tr><td>N</td><td>±30%</td></tr> </table>	Inductance tolerance		J	±5%	K	±10%	M	±20%	N	±30%	
Core dimension(mm)																																											
04	4.7																																										
05	5.6																																										
06	6.8																																										
08	9.0																																										
Height(mm)																																											
	04 type	05 type	06 type	08 type																																							
A	3.0max.	—	—	6.0max.																																							
B	2.0max.	2.8max.	3.2max.	5.0max.																																							
Inductance tolerance																																											
J	±5%																																										
K	±10%																																										
M	±20%																																										
N	±30%																																										

外形寸法 EXTERNAL DIMENSIONS

Type	非シールド Non-Shielded type		磁気シールド Shielded type				非シールド Non-Shielded type	
	N05D	N06D	NP04S		NP05D NH05D	NP06D NH06D	N08DP	
Fig.								
高さ記号 Height code	B	B	A	B, ZB	B	B	A	B
L	5.9±0.3 (0.232±0.012)	7.3±0.3 (0.287±0.012)	5.0±0.2 (0.197±0.008)	5.0±0.2 (0.197±0.008)	5.9±0.3 (0.232±0.012)	7.0±0.3 (0.276±0.012)	9.0±0.2 (0.354±0.008)	
W	6.1±0.3 (0.240±0.012)	7.5±0.3 (0.295±0.012)	5.0±0.2 (0.197±0.008)	5.0±0.2 (0.197±0.008)	6.1±0.3 (0.240±0.012)	7.5±0.3 (0.295±0.012)	10.6±0.2 (0.417±0.008)	
H(max.)	2.8 (0.110)	3.2 (0.126)	3.0 (0.118)	2.0 (0.079)	2.8 (0.110)	3.2 (0.126)	6.0 (0.236)	5.0 (0.197)
a	2.0±0.3 (0.079±0.012)	2.0±0.3 (0.079±0.012)	1.3±0.1 (0.051±0.004)	1.3±0.1 (0.051±0.004)	2.0±0.3 (0.079±0.012)	2.0±0.3 (0.079±0.012)	1.6±0.2 (0.063±0.008)	
b	4.2±0.3 (0.165±0.012)	5.7±0.3 (0.224±0.012)	5.8±0.3 (0.228±0.012)	5.8±0.3 (0.228±0.012)	4.2±0.3 (0.165±0.012)	5.7±0.3 (0.224±0.012)	5.1±0.2 (0.201±0.008)	

Unit : mm(inch)

概略バリエーション AVAILABLE INDUCTANCE RANGE

Type	N05D		N06D		NP04S		NP04SZ		NP05D		NH05D		NP06D		NH06D		N08DP					
高さ記号 (min.)	B (2.8max.)		B (3.2max.)		A (3.0max.)		B (2.0max.)		B (2.0max.)		B (2.8max.)		B (2.8max.)		B (3.2max.)		B (3.2max.)		A (6.0max.)		B (5.0max.)	
Inductance (H)	Rdc (Ω)	I _{max} (A)	Rdc (Ω)	I _{max} (A)	Rdc (Ω)	I _{max} (A)	Rdc (Ω)	I _{max} (A)	Rdc (Ω)	I _{max} (A)	Rdc (Ω)	I _{max} (A)	Rdc (Ω)	I _{max} (A)	Rdc (Ω)	I _{max} (A)	Rdc (Ω)	I _{max} (A)	Rdc (Ω)	I _{max} (A)	Rdc (Ω)	I _{max} (A)
1μ	0.021	3.7	0.021	3.9			0.036	1.3	0.060	2.0	0.016	3.0	0.016	4.2	0.018	4.0	0.019	4.6	0.028	3.9	0.023	4.0
10μ	0.1	1.6	0.079	1.7	0.052	0.9	0.066	0.9		1.2	0.062	1.0	0.062	1.3	0.074	1.2	0.075	2.0	0.066	2.2	0.069	2.2
100μ	0.83	0.55	0.68	0.6							0.84	0.32	0.84	0.45	0.70	0.42	0.70	0.55	0.35	1.05	0.49	0.82
1000μ			8.2	0.16											7.1	0.12	7.1	0.17	3.1	0.34	4.4	0.27

セレクションガイド
Selection Guide

アイテム一覧
Part Numbers

特性図
Electrical Characteristics

梱包
Packaging

信頼性
Reliability Data

使用上の注意
Precautions



etc

NP04SAシールドタイプ Shielded type

形名 Ordering code	公称 インダクタンス Inductance [μ H]	インダクタンス 許容差 Inductance Tolerance	自己共振 周波数 Self-resonant frequency [MHz] (min.)	直流抵抗 DC Resistance [Ω]		定格電流 Rated current [A] (max.)	測定 周波数 Measuring frequency
				(max.)	(typ.)		
NP04S A100M	10	±20%	20	0.052	0.045	0.9	1kHz
NP04S A220M	22		13	0.11	0.90	0.53	
NP04S A330M	33		12	0.16	0.13	0.44	

NP04SBシールドタイプ Shielded type

形名 Ordering code	公称 インダクタンス Inductance [μ H]	インダクタンス 許容差 Inductance Tolerance	自己共振 周波数 Self-resonant frequency [MHz] (min.)	直流抵抗 DC Resistance [Ω]		定格電流 Rated current [A] (max.)	測定 周波数 Measuring frequency
				(max.)	(typ.)		
NP04S B3R3N	3.3	±30%	40	0.036	0.030	1.3	1kHz
NP04S B4R7N	4.7		30	0.050	0.033	1.2	
NP04S B6R8N	6.8		27	0.053	0.043	1.05	
NP04S B100M	10	±20%	19	0.066	0.054	0.9	
NP04S B150M	15		15	0.12	0.10	0.62	
NP04S B220M	22		12	0.15	0.12	0.51	
NP04S B330M	33		10	0.26	0.21	0.42	
NP04S B470M	47		8	0.32	0.27	0.38	

NP04SZシールドタイプ Shielded type

形名 Ordering code	公称 インダクタンス Inductance [μ H]	インダクタンス 許容差 Inductance Tolerance	自己共振 周波数 Self-resonant frequency [MHz] (min.)	直流抵抗 DC Resistance [Ω]		定格電流 Rated current [A] (max.)	測定 周波数 Measuring frequency
				(max.)	(typ.)		
NP04S ZB 3R3N	3.3	±30%	30	0.060	0.040	2.0	1kHz
NP04S ZB 4R7N	4.7		27	0.10	0.075	1.6	
NP04S ZB 6R8N	6.8		19	0.12	0.090	1.4	
NP04S ZB 100M	10	±20%	15	0.13	0.10	1.2	
NP04S ZB 150M	15		12	0.25	0.18	0.95	
NP04S ZB 220M	22		10	0.30	0.21	0.77	

N05DB 非シールドタイプ Non-Shielded type

形名 Ordering code	公称 インダクタンス Inductance [μH]	インダクタンス 許容差 Inductance Tolerance	自己共振 周波数 Self-resonant frequency [MHz] (min.)	直流抵抗 DC Resistance [Ω] (max.)	定格電流 Rated current [A] (max.)	測定 周波数 Measuring frequency
N 05D B1R0M	1.0	±20%	85	0.021	3.7	1kHz
N 05D B1R5M	1.5		69	0.025	3.2	
N 05D B2R2M	2.2		51	0.032	2.9	
N 05D B3R3M	3.3		45	0.040	2.5	
N 05D B4R7M	4.7		35	0.049	2.2	
N 05D B6R8M	6.8		30	0.070	2.1	
N 05D B100K	10	±10%	25	0.10	1.6	
N 05D B150K	15		24	0.16	1.40	
N 05D B220K	22		18	0.22	1.20	
N 05D B330K	33		14	0.35	0.80	
N 05D B470K	47		12	0.43	0.75	
N 05D B680K	68		9.7	0.66	0.65	
N 05D B101K	100		8.3	0.83	0.55	

NP05DB シールドタイプ Shielded type

形名 Ordering code	公称 インダクタンス Inductance [μH]	インダクタンス 許容差 Inductance Tolerance	自己共振 周波数 Self-resonant frequency [MHz] (min.)	直流抵抗 DC Resistance [Ω] (max.)	定格電流 Rated current [A] (max.)	測定 周波数 Measuring frequency
NP05D B1R0M	1.0	±20%	86	0.019	3.0	1kHz
NP05D B1R5M	1.5		68	0.023	2.7	
NP05D B2R2M	2.2		54	0.026	2.1	
NP05D B3R3M	3.3		41	0.031	1.8	
NP05D B4R7M	4.7		34	0.038	1.4	
NP05D B6R8M	6.8		26	0.053	1.1	
NP05D B100M	10		25	0.062	1.0	
NP05D B150M	15		20	0.097	0.80	
NP05D B220M	22		16	0.15	0.69	
NP05D B330M	33		13	0.24	0.54	
NP05D B470M	47		11	0.40	0.46	
NP05D B680M	68		9.5	0.46	0.40	
NP05D B101M	100		7.7	0.84	0.32	

NH05DB シールドタイプ Shielded type

形名 Ordering code	公称 インダクタンス Inductance [μH]	インダクタンス 許容差 Inductance Tolerance	自己共振 周波数 Self-resonant frequency [MHz] (min.)	直流抵抗 DC Resistance [Ω] (max.)	定格電流 Rated current [A] (max.)	測定 周波数 Measuring frequency
NH05D B1R0M	1.0	±20%	86	0.016	4.2	1kHz
NH05D B1R5M	1.5		68	0.020	3.3	
NH05D B2R2M	2.2		54	0.023	2.7	
NH05D B3R3M	3.3		41	0.031	2.4	
NH05D B4R7M	4.7		34	0.038	2.0	
NH05D B6R8M	6.8		26	0.056	1.7	
NH05D B100M	10		25	0.062	1.3	
NH05D B150M	15		20	0.097	1.10	
NH05D B220M	22		16	0.15	0.90	
NH05D B330M	33		13	0.24	0.72	
NH05D B470M	47		11	0.40	0.66	
NH05D B680M	68		9.5	0.46	0.53	
NH05D B101M	100		7.7	0.84	0.45	

N06DB 非シールドタイプ Non-Shielded type

形名 Ordering code	公称 インダクタンス Inductance [μH]	インダクタンス 許容差 Inductance Tolerance	自己共振 周波数 Self-resonant frequency [MHz] (min.)	直流抵抗 DC Resistance [Ω] (max.)	定格電流 Rated current [A] (max.)	測定 周波数 Measuring frequency
N 06D B1R0M	1.0	±20%	87	0.021	3.9	1kHz
N 06D B2R2M	2.2		53	0.029	3.2	
N 06D B4R7M	4.7		33	0.046	2.5	
N 06D B100K	10	±10%	22	0.079	1.7	
N 06D B150K	15		18	0.12	1.3	
N 06D B220K	22		13	0.17	1.1	
N 06D B330K	33		9.8	0.25	0.95	
N 06D B470K	47		8.8	0.32	0.80	
N 06D B680K	68		8.1	0.45	0.70	
N 06D B101K	100		7.9	0.68	0.60	
N 06D B151K	150		6.0	1.0	0.48	
N 06D B221K	220		5.2	1.4	0.40	
N 06D B331K	330		4.4	2.3	0.32	
N 06D B471K	470	3.4	3.6	0.25		
N 06D B681K	680	2.6	4.6	0.21		
N 06D B102J	1000	±5%	2.1	8.2	0.16	

NP06DB シールドタイプ Shielded type

形名 Ordering code	公称 インダクタンス Inductance [μH]	インダクタンス 許容差 Inductance Tolerance	自己共振 周波数 Self-resonant frequency [MHz] (min.)	直流抵抗 DC Resistance [Ω] (max.)	定格電流 Rated current [A] (max.)	測定 周波数 Measuring frequency
NP06D B1R0M	1.0	±20%	90	0.018	4.0	1kHz
NP06D B1R5M	1.5		71	0.022	3.0	
NP06D B2R2M	2.2		53	0.025	2.8	
NP06D B3R3M	3.3		39	0.033	2.3	
NP06D B4R7M	4.7		36	0.037	2.0	
NP06D B6R8M	6.8		28	0.051	1.7	
NP06D B100M	10		20	0.074	1.2	
NP06D B150M	15		17	0.11	1.1	
NP06D B220M	22		14	0.16	0.90	
NP06D B330M	33		10	0.21	0.78	
NP06D B470M	47		9.3	0.30	0.64	
NP06D B680M	68		8.0	0.45	0.51	
NP06D B101M	100		6.7	0.70	0.42	
NP06D B151M	150		5.3	0.89	0.34	
NP06D B221M	220		4.8	1.5	0.28	
NP06D B331M	330		3.7	2.5	0.24	
NP06D B471M	470		3.0	3.0	0.18	
NP06D B681M	680		2.5	5.5	0.16	
NP06D B102M	1000		2.0	7.1	0.12	

NH06DB シールドタイプ Shielded type

形名 Ordering code	公称 インダクタンス Inductance [μH]	インダクタンス 許容差 Inductance Tolerance	自己共振 周波数 Self-resonant frequency [MHz] (min.)	直流抵抗 DC Resistance [Ω] (max.)	定格電流 Rated current [A] (max.)	測定 周波数 Measuring frequency
NH06D B1R0M	1.0	±20%	90	0.019	4.6	1kHz
NH06D B1R5M	1.5		71	0.023	4.0	
NH06D B2R2M	2.2		53	0.026	3.4	
NH06D B3R3M	3.3		39	0.034	3.3	
NH06D B4R7M	4.7		36	0.038	3.0	
NH06D B6R8M	6.8		28	0.052	2.5	
NH06D B100M	10		20	0.075	2.0	
NH06D B150M	15		17	0.11	1.7	
NH06D B220M	22		14	0.16	1.4	
NH06D B330M	33		10	0.21	1.1	
NH06D B470M	47		9.3	0.31	0.83	
NH06D B680M	68		8.0	0.45	0.69	
NH06D B101M	100		6.7	0.70	0.55	
NH06D B151M	150		5.3	0.89	0.45	
NH06D B221M	220		4.8	1.5	0.38	
NH06D B331M	330		3.7	2.5	0.31	
NH06D B471M	470		3.0	3.0	0.26	
NH06D B681M	680		2.5	5.5	0.21	
NH06D B102M	1000		2.0	7.1	0.17	

N08DPA 非シールドタイプ Non-Shielded type

形名 Ordering code	公称 インダクタンス Inductance [μH]	インダクタンス 許容差 Inductance Tolerance	自己共振 周波数 Self-resonant frequency [MHz] (min.)	直流抵抗 DC Resistance [Ω] (max.)	定格電流 Rated current [A] (max.)	測定 周波数 Measuring frequency
N 08DPA1R0M	1.0	±20%	86	0.028	3.9	1kHz
N 08DPA1R5M	1.5		69	0.030	3.4	
N 08DPA2R2M	2.2		58	0.036	3.2	
N 08DPA3R3M	3.3		50	0.039	3.0	
N 08DPA4R7M	4.7		30	0.047	2.6	
N 08DPA6R8M	6.8		21	0.057	2.4	
N 08DPA100K	10	±10%	18	0.066	2.2	
N 08DPA120K	12		16	0.077	2.1	
N 08DPA150K	15		14	0.087	2.0	
N 08DPA180K	18		13	0.092	1.9	
N 08DPA220K	22		11	0.11	1.8	
N 08DPA270K	27		10	0.12	1.6	
N 08DPA330K	33		9.5	0.14	1.55	
N 08DPA390K	39		8.9	0.15	1.5	
N 08DPA470K	47		8.6	0.17	1.4	
N 08DPA560K	56		8.3	0.19	1.35	
N 08DPA680K	68		7.9	0.23	1.3	
N 08DPA820K	82		7.3	0.30	1.1	
N 08DPA101K	100		6.7	0.35	1.05	
N 08DPA121K	120		6.5	0.40	0.95	
N 08DPA151K	150		6.0	0.55	0.80	
N 08DPA181K	180		4.9	0.62	0.76	
N 08DPA221K	220		4.1	0.80	0.66	
N 08DPA271K	270		3.4	0.90	0.63	
N 08DPA331K	330		3.2	1.1	0.59	
N 08DPA391K	390		2.9	1.2	0.54	
N 08DPA471K	470		2.6	1.5	0.50	
N 08DPA561K	560		2.4	1.7	0.45	
N 08DPA681K	680		2.2	2.4	0.38	
N 08DPA821K	820		1.9	2.6	0.36	
N 08DPA102J	1000	±5%	1.8	3.1	0.34	

N08DPB 非シールドタイプ Non-Shielded type

形名 Ordering code	公称 インダクタンス Inductance [μH]	インダクタンス 許容差 Inductance Tolerance	自己共振 周波数 Self-resonant frequency [MHz] (min.)	直流抵抗 DC Resistance [Ω] (max.)	定格電流 Rated current [A] (max.)	測定 周波数 Measuring frequency
N 08DPB1R0M	1.0	±20%	98	0.023	4.0	1kHz
N 08DPB1R5M	1.5		73	0.028	3.7	
N 08DPB2R2M	2.2		56	0.032	3.4	
N 08DPB3R3M	3.3		42	0.037	3.2	
N 08DPB4R7M	4.7		32	0.047	2.7	
N 08DPB6R8M	6.8		26	0.057	2.4	
N 08DPB100K	10	±10%	21	0.069	2.2	
N 08DPB120K	12		20	0.074	2.1	
N 08DPB150K	15		17	0.087	2.0	
N 08DPB180K	18		16	0.099	1.9	
N 08DPB220K	22		14	0.12	1.8	
N 08DPB270K	27		13	0.15	1.5	
N 08DPB330K	33		12	0.18	1.4	
N 08DPB390K	39		11	0.19	1.3	
N 08DPB470K	47		10	0.22	1.2	
N 08DPB560K	56		9.2	0.29	1.1	
N 08DPB680K	68		8.3	0.34	1.0	
N 08DPB820K	82		7.6	0.39	0.94	
N 08DPB101K	100		7.3	0.49	0.82	
N 08DPB121K	120		6.8	0.54	0.79	
N 08DPB151K	150		6.2	0.66	0.75	
N 08DPB181K	180		5.8	0.75	0.68	
N 08DPB221K	220		5.0	0.92	0.63	
N 08DPB271K	270		4.5	1.1	0.56	
N 08DPB331K	330		4.2	1.5	0.48	
N 08DPB391K	390		4.0	1.7	0.45	
N 08DPB471K	470		3.0	2.1	0.41	
N 08DPB561K	560		2.7	2.4	0.38	
N 08DPB681K	680		2.5	2.7	0.36	
N 08DPB821K	820		2.4	3.1	0.33	
N 08DPB102J	1000	±5%	2.1	4.4	0.27	

特性図 ELECTRICAL CHARACTERISTICS

直流重畳特性例 DC Bias characteristics(Measured by HP4262A)

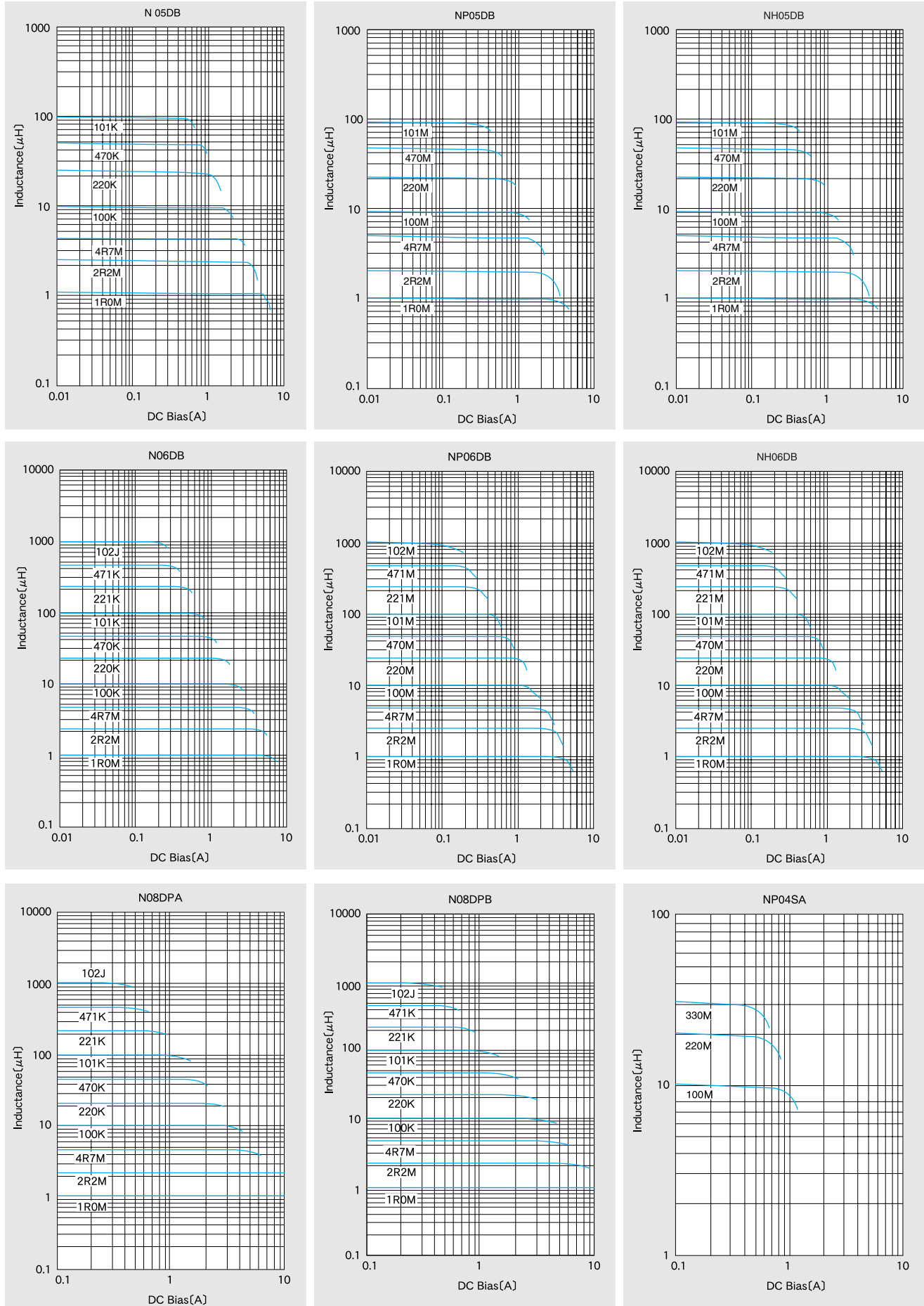

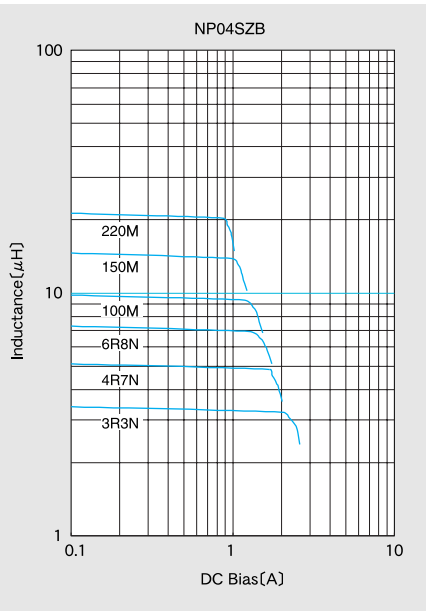
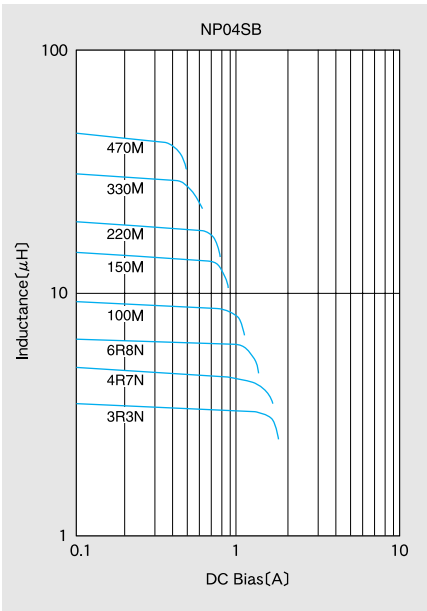

温度特性例 Temperature characteristics (Measured by HP4262A)

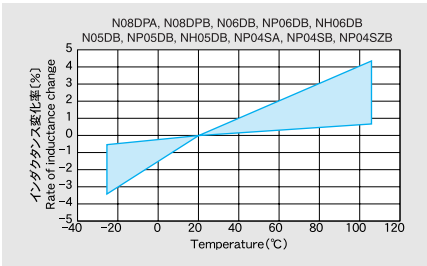

①最小受注単位数 Minimum Quantity

形式 Type	高さ記号 Height code	標準数量 Standard quantity (pcs.)
		テーピング Taped
NP04S	A	2000
NP04S, SZ	B	3000
N05D	B	1500
NP05D/NH05D	B	1500
N06D	B	1500
NP06D/NH06D	B	1500
N08DP	A	1000
N08DP	B	1500

②テーピング材質 Tape Material

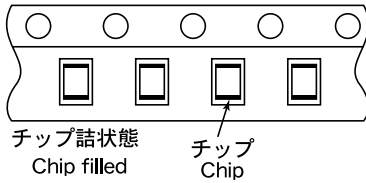
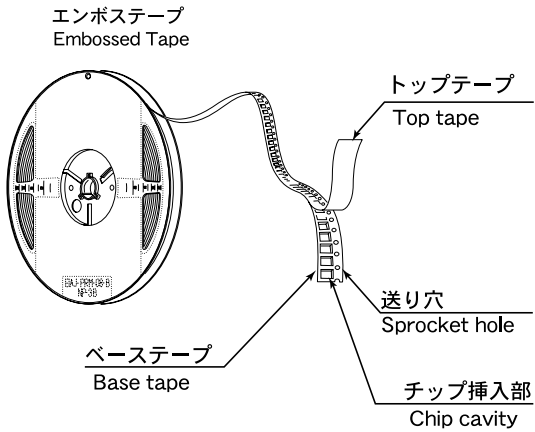

③テーピング寸法 Taping dimensions

(1)エンボステープ (16mm幅) Embossed tape (0.63 inches wide)

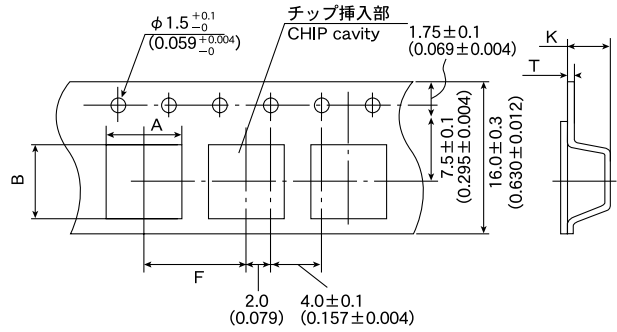

形式 Type	高さ記号 Height code	チップ挿入部 Chip cavity		挿入ピッチ Insertion pitch F	テープ厚み Tape thickness	
		A	B		K	T
N 05D	B	6.1 (0.240)	6.3 (0.248)	12 (0.472)	3.4 (0.134)	0.4 (0.016)
NP05D NH05D	B	6.1 (0.240)	6.3 (0.248)	12 (0.472)	3.4 (0.134)	0.4 (0.016)
N06D	B	7.5 (0.295)	7.7 (0.303)	12 (0.472)	3.5 (0.138)	0.4 (0.016)
NP06D NH06D	B	7.5 (0.295)	7.7 (0.303)	12 (0.472)	3.5 (0.138)	0.4 (0.016)

Unit : mm (inch)

公差のない数値は参考値です。

The values without tolerance are for reference only.

梱包 PACKAGING

Tape Material

(2)エンボステープ (24mm幅) Embossed Tape(0.94 inches wide)

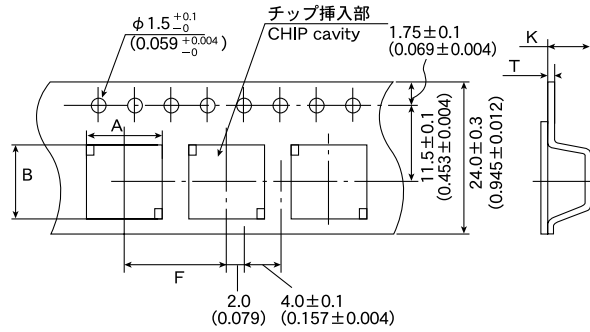

形式 Type	高さ記号 Height code	チップ挿入部 Chip cavity		挿入ピッチ Insertion pitch	テープ厚み Tape thickness	
		A	B		F	K
N08DP	A	9.4 (0.370)	11.0 (0.433)	12 (0.472)	6.0 (0.236)	0.4 (0.016)
	B	9.4 (0.370)	11.0 (0.433)	12 (0.472)	5.0 (0.197)	0.4 (0.016)

Unit : mm(inch)

公差のない数値は参考値です。

The values without tolerance are for reference only.

(3)エンボステープ (12mm幅) Embossed Tape(0.47 inches wide)

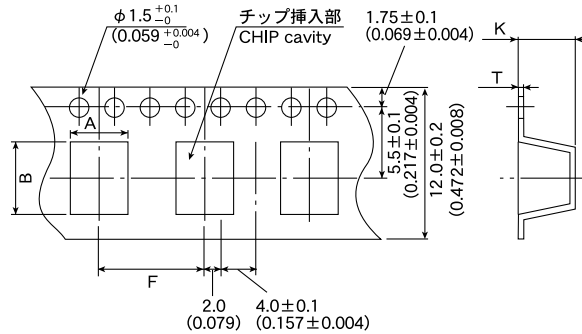

形式 Type	高さ記号 Height code	チップ挿入部 Chip cavity		挿入ピッチ Insertion pitch	テープ厚み Tape thickness	
		A	B		F	K
NP04S	A	5.25 (0.207)	5.25 (0.207)	8.0 (0.315)	3.7 (0.146)	0.4 (0.016)
NP04S NP04SZ	B	5.25 (0.207)	5.25 (0.207)	8.0 (0.315)	2.7 (0.106)	0.4 (0.016)

Unit : mm(inch)

④リーダー部・空部 Leader and Blank portion

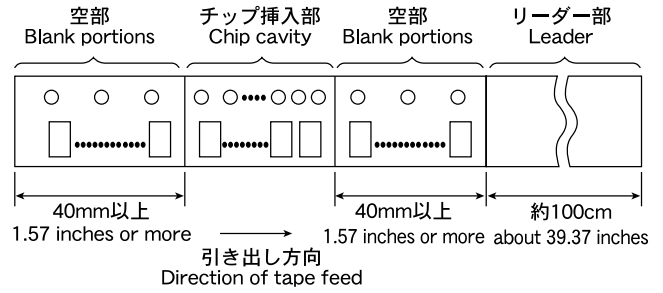

⑤リール寸法 Reel size

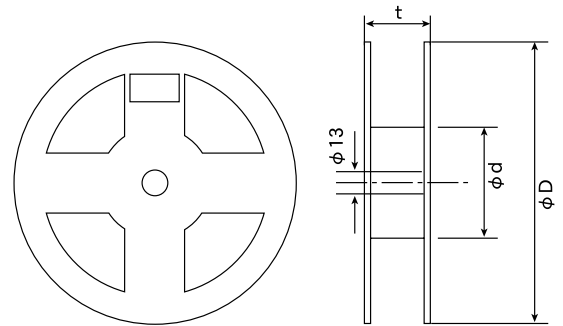

形式 Type	リール寸法 Reel size(mm) (参考値 Reference values)		
	φD	φd	t
NP04S	330(12.99)	80(3.15)	17.5(0.689)
N05D	330(12.99)	80(3.15)	21.5(0.846)
NP05D/NH05D	330(12.99)	80(3.15)	21.5(0.846)
N06D	330(12.99)	80(3.15)	21.5(0.846)
NP06D/NH06D	330(12.99)	80(3.15)	21.5(0.846)
N08DP	380(14.96)	80(3.15)	29.5(1.16)

⑥トップテープ強度 Top Tape Strength

トップテープのはがし力は、下図矢印方向にて0.1~0.7Nとなります。

The top tape requires a peel-off force of 0.1 to 0.7N in the direction of the arrow as illustrated below.

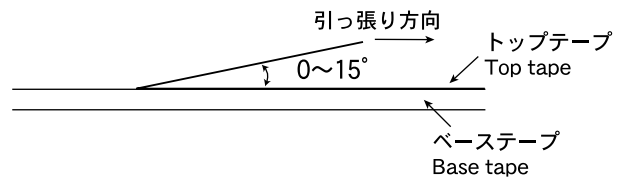

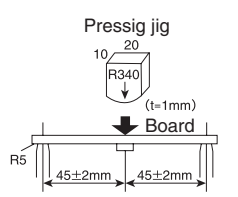
Item	Specified Value					Test Method and Remarks										
	Surface Mount High current inductors 08 Type	Surface Mount High current inductors 04/05/06 Type	CommonMode Choke Coils CM04RC	CommonMode Choke Coils BU05MC	Balun Transformers BU05MC											
1. Operating Temperature Range	-25°C~+85°C	-25~+105°C				Including self-generated heat										
2. Storage Temperature Range	-40°C~+85°C					Common mode choke coil Balun transformers : -5 to +40°C in taped packaging										
3. Rated current	Within the specification		Within the specified tolerance			MSD inductor : The maximum DC value having inductance decrease within specified value and temperature increase within 40°C by the application of DC bias. Inductance decrease <table border="1"> <tr> <td>04, NH05, NH06</td> <td>05</td> <td>06</td> </tr> <tr> <td>30%</td> <td>20%</td> <td>10%</td> </tr> </table> Common mode choke coil : The maximum DC value having temperature increase within specified temperature, as detailed in individual specification.	04, NH05, NH06	05	06	30%	20%	10%				
04, NH05, NH06	05	06														
30%	20%	10%														
4. Impedance			Within the specified tolerance			Common mode choke coil : Measuring equipment : HP 4291A or its equivalent Measuring frequency : Specified frequency										
5. Inductance	Within the specified tolerance				Refer to individual specification	SMD inductor : Measuring equipment : HP 4284A or its equivalent Measuring frequency : 1kHz Measuring voltage : 1V osc. Measurement in series connection										
6. DC Resitance	Within the specified tolerance					SMD transformer · SMD inductor · Common mode choke coil : Measuring equipment : DC ohmmeter										
7. Self resonance frequency	Within the specification					SMD inductor : Measuring equipment : Impedance analyzer (HP 4191A, 4192A) or its equivalent										
8. Temperature characteristic	04, 05, 06 Type : Within ±10% 08 Type : Within ±5%					SMD inductor : Change of maximum inductance deviation in step 1 to 5 <table border="1"> <tr> <td>Temperature at step 1</td> <td>20°C</td> </tr> <tr> <td>Temperature at step 2</td> <td>Minimum operating temperature</td> </tr> <tr> <td>Temperature at step 3</td> <td>20°C (Standard temperature)</td> </tr> <tr> <td>Temperature at step 4</td> <td>Maximum operating temperature</td> </tr> <tr> <td>Temperature at step 5</td> <td>20°C</td> </tr> </table>	Temperature at step 1	20°C	Temperature at step 2	Minimum operating temperature	Temperature at step 3	20°C (Standard temperature)	Temperature at step 4	Maximum operating temperature	Temperature at step 5	20°C
Temperature at step 1	20°C															
Temperature at step 2	Minimum operating temperature															
Temperature at step 3	20°C (Standard temperature)															
Temperature at step 4	Maximum operating temperature															
Temperature at step 5	20°C															
9. Resitance to flexure of substrare			Refer to individual specification.			Common mode choke coil : According to JIS C0051 <table border="1"> <tr> <td></td> <td>CM04RC · BU05MC</td> </tr> <tr> <td>Warp</td> <td>3mm</td> </tr> <tr> <td>Pressing speed</td> <td>0.5mm/sec.</td> </tr> <tr> <td>Duration</td> <td>5±1sec.</td> </tr> </table> 		CM04RC · BU05MC	Warp	3mm	Pressing speed	0.5mm/sec.	Duration	5±1sec.		
	CM04RC · BU05MC															
Warp	3mm															
Pressing speed	0.5mm/sec.															
Duration	5±1sec.															

Item	Specified Value					Test Method and Remarks													
	Surface Mount High current inductors 08 Type	Surface Mount High current inductors 04/05/06 Type	CommonMode Choke Coils CM04RC	CommonMode Choke Coils BU05MC	Balun Transformers BU05MC														
10.Standard donndityonn	Note on standard condition: "standard condition" referred to herein is defined as follows: 5 to 35°C of temperature, 45 to 85% relative humidity and 86 to 106kPa of air pressure. When there are questions concerning measurement results: In order to provide correlation data, the test shall be conducted under condition of 20±2°C of temperature, 45 to 85% relative humidity and 86 to 106kPa of air pressure. Unless otherwise specified, all the tests are conducted under the "standard condition."																		
11. Insulation resistance : between wires	100MΩ min.					SMD inductor : Applied voltage : 100VDC Duration : 60sec. Common mode choke coil : Applied voltage : Rated voltage Duration : 60 sec.													
12. Insulation resistance : between wire and core	100MΩ min.					SMD inductor : Applied voltage : 100VDC Duration : 60sec.													
13. Rated current	Within the specification																		
14. Withstanding voltage : between wires	No abnormality					Common mode choke coil : Applied voltage : Regulation voltage Duration : 60 sec.													
15. Withstanding voltage : between wire and core	No abnormality					SMD inductor : Applied voltage : 500VAC Duration : 60 sec.													
16. Adhesion of terminal electrode	No abnormality					SMD inductor : Set testing jigs perpendicularly to top surface of specimen mounted on printed board, and apply specified static load for 5 sec. Specified static load <table border="1" style="margin-left: 20px;"> <thead> <tr> <th>Type</th> <th>static load</th> </tr> </thead> <tbody> <tr> <td>N08DP</td> <td>10N</td> </tr> <tr> <td>NP04S</td> <td rowspan="6">5N</td> </tr> <tr> <td>N05D</td> </tr> <tr> <td>NP05D</td> </tr> <tr> <td>NH05D</td> </tr> <tr> <td>N06D</td> </tr> <tr> <td>NP06D</td> </tr> <tr> <td>NH06D</td> <td></td> </tr> </tbody> </table>	Type	static load	N08DP	10N	NP04S	5N	N05D	NP05D	NH05D	N06D	NP06D	NH06D	
Type	static load																		
N08DP	10N																		
NP04S	5N																		
N05D																			
NP05D																			
NH05D																			
N06D																			
NP06D																			
NH06D																			
17. Resitance to vibration	Impedance change : Within : ±5%	Refer to individual specification.				SMD inductor, Common mode choke coil : Accoding to JIS C0040 Directions : 2 hrs each in X, Y, and Z directions. Total : 6 hrs Frequency range : 10 to 55 to 10 Hz (1 min.) Amplitude : 1.5mm (Shall not exceed acceleration 196m/s ²) Mounting method : soldering onto printed board Recovery : At least 2 hrs of recovery under the standard condition after the test, followed by the measurement within 24 hrs. A kind of vibration : A													
18. Solderability	95% or more of mounting terminal side shall be covered with tresh solder.	At least 75% of terminal electrode is covered by new solder.				SMD inductor Solder temperature : 230±5°C Duration : 2±0.5 sec. Immersion depth : All sides of mounting terminal shall be immersed. Common mode choke coil : <table border="1" style="margin-left: 20px;"> <thead> <tr> <th></th> <th>CM04RC · BU05MC</th> </tr> </thead> <tbody> <tr> <td>Solder temperature</td> <td>235±5°C</td> </tr> <tr> <td>Duration</td> <td>2±0.5 sec.</td> </tr> <tr> <td>Immersion depth</td> <td>Up to 0.5mm from terminal root</td> </tr> </tbody> </table>		CM04RC · BU05MC	Solder temperature	235±5°C	Duration	2±0.5 sec.	Immersion depth	Up to 0.5mm from terminal root					
	CM04RC · BU05MC																		
Solder temperature	235±5°C																		
Duration	2±0.5 sec.																		
Immersion depth	Up to 0.5mm from terminal root																		

Item	Specified Value					Test Method and Remarks																																																				
	Surface Mount High current inductors 08 Type	Surface Mount High current inductors 04/05/06 Type	CommonMode Choke Coils CM04RC	CommonMode Choke Coils BU05MC	Balun Transformers BU05MC																																																					
19. Resistance to soldering heat	No abnormality		Refer to individual specification.			<p>SMD inductor (Reflow soldering)</p> <table border="1"> <tr> <td>Temperature range</td> <td>150~180°C</td> <td>200°Cmin</td> <td>Peak temperature 240~250°C</td> </tr> <tr> <td>Duration</td> <td>100~120sec</td> <td>40~60sec</td> <td>Within 5sec</td> </tr> </table> <p>Recommended reflow conditions</p> <p>Recovery : At least 2 hrs of recovery under the standard condition after the removal from test chamber, followed by the measurement within 24 hrs.</p> <p>Common mode choke coil :</p> <p>① Reflow soldering</p> <p>Preheating : 100 to 150°C 1 to 2min. Peak : 230 to 240°C Within 5sec. More than 200°C Within 40 sec. Number of reflow : Within 2 times.</p> <p>② Manual soldering</p> <p>Solder temperature : 350±5°C Duration : 3±1sec. Recovery : 1 to 2 hrs of recovery under the standard condition after the test.</p>	Temperature range	150~180°C	200°Cmin	Peak temperature 240~250°C	Duration	100~120sec	40~60sec	Within 5sec																																												
Temperature range	150~180°C	200°Cmin	Peak temperature 240~250°C																																																							
Duration	100~120sec	40~60sec	Within 5sec																																																							
20. Thermal shock	Inductance change : Within : ±10%		Refer to individual specification.			<p>SMD inductor</p> <p>According to JIS C0025</p> <p>SMD inductor(08 type)</p> <table border="1"> <thead> <tr> <th colspan="3">Conditions of 1 cycle</th> </tr> <tr> <th>Step</th> <th>Temperature(°C)</th> <th>Duration(min)</th> </tr> </thead> <tbody> <tr> <td>1</td> <td>-25⁺⁰₋₃</td> <td>30±3</td> </tr> <tr> <td>2</td> <td>Room temperature</td> <td>Within 3</td> </tr> <tr> <td>3</td> <td>+85⁺²₋₀</td> <td>30±3</td> </tr> <tr> <td>4</td> <td>Room temperature</td> <td>Within 3</td> </tr> </tbody> </table> <p>SMD inductor(04, 05, 06 type)</p> <table border="1"> <thead> <tr> <th colspan="3">Conditions of 1 cycle</th> </tr> <tr> <th>Step</th> <th>Temperature(°C)</th> <th>Duration(min)</th> </tr> </thead> <tbody> <tr> <td>1</td> <td>-25⁺⁰₋₃</td> <td>30±3</td> </tr> <tr> <td>2</td> <td>Room temperature</td> <td>Within 3</td> </tr> <tr> <td>3</td> <td>+105⁺²₋₀</td> <td>30±3</td> </tr> <tr> <td>4</td> <td>Room temperature</td> <td>Within 3</td> </tr> </tbody> </table> <p>Number of cycle : 10 cycles</p> <p>Recovery : At least 2 hrs of recovery under the standard condition after the removal from test chamber, followed by the measurement within 24 hrs.</p> <p>Common mode choke coil :</p> <p>According to JIS C0025</p> <p>Conditions of 1 cycle</p> <table border="1"> <thead> <tr> <th rowspan="2"></th> <th>Temperature(°C)</th> <th rowspan="2">Duration(min)</th> </tr> <tr> <th>CM04RC · BU05MC</th> </tr> </thead> <tbody> <tr> <td>1</td> <td>-25±3°C</td> <td>30±3</td> </tr> <tr> <td>2</td> <td>Room temperature</td> <td>3</td> </tr> <tr> <td>3</td> <td>85±2°C</td> <td>30±3</td> </tr> <tr> <td>4</td> <td>Room temperature</td> <td>3</td> </tr> </tbody> </table> <p>Number of cycle : 10 cycles</p> <p>Recovery : 1~2 hrs of recovery under the standard condition after removal from test chamber.</p>	Conditions of 1 cycle			Step	Temperature(°C)	Duration(min)	1	-25 ⁺⁰ ₋₃	30±3	2	Room temperature	Within 3	3	+85 ⁺² ₋₀	30±3	4	Room temperature	Within 3	Conditions of 1 cycle			Step	Temperature(°C)	Duration(min)	1	-25 ⁺⁰ ₋₃	30±3	2	Room temperature	Within 3	3	+105 ⁺² ₋₀	30±3	4	Room temperature	Within 3		Temperature(°C)	Duration(min)	CM04RC · BU05MC	1	-25±3°C	30±3	2	Room temperature	3	3	85±2°C	30±3	4	Room temperature	3
Conditions of 1 cycle																																																										
Step	Temperature(°C)	Duration(min)																																																								
1	-25 ⁺⁰ ₋₃	30±3																																																								
2	Room temperature	Within 3																																																								
3	+85 ⁺² ₋₀	30±3																																																								
4	Room temperature	Within 3																																																								
Conditions of 1 cycle																																																										
Step	Temperature(°C)	Duration(min)																																																								
1	-25 ⁺⁰ ₋₃	30±3																																																								
2	Room temperature	Within 3																																																								
3	+105 ⁺² ₋₀	30±3																																																								
4	Room temperature	Within 3																																																								
	Temperature(°C)	Duration(min)																																																								
	CM04RC · BU05MC																																																									
1	-25±3°C	30±3																																																								
2	Room temperature	3																																																								
3	85±2°C	30±3																																																								
4	Room temperature	3																																																								

Item	Specified Value					Test Method and Remarks										
	Surface Mount High current inductors 08 Type	Surface Mount High current inductors 04/05/06 Type	CommonMode Choke Coils CM04RC	CommonMode Choke Coils BU05MC	Balun Transformers BU05MC											
21.Damp heat (steady state)			Refer to individual specification.			Commom mode choke coil : <table border="1"> <tr> <td></td> <td>CM04RC · BU05MC</td> </tr> <tr> <td>Temperature</td> <td>40±2℃</td> </tr> <tr> <td>Humidity</td> <td>90~95%</td> </tr> <tr> <td>Duration</td> <td>1000±24</td> </tr> </table>		CM04RC · BU05MC	Temperature	40±2℃	Humidity	90~95%	Duration	1000±24		
	CM04RC · BU05MC															
Temperature	40±2℃															
Humidity	90~95%															
Duration	1000±24															
22.Loading under damp heat	Inductance change : Within : ±10%		Refer to individual specification.			SMD inductor : Temperature : 40±2℃ Humidity : 90~95% Applied current : Rated current Duration : 240±2hrs Recovery : At least 2 hrs of recvery under the standard condition after rhe removal from test chamber, followed by the measurement within 24 hrs. Commom mode choke coil : <table border="1"> <tr> <td></td> <td>CM04RC · BU05MC</td> </tr> <tr> <td>Temperature</td> <td>40±2℃</td> </tr> <tr> <td>Humidity</td> <td>90~95%</td> </tr> <tr> <td>Applied current</td> <td>Rated current</td> </tr> <tr> <td>Duration</td> <td>1000±24</td> </tr> </table> Recovery : 1~2 hrs of recovery under the standard condition after the removed from test chamber		CM04RC · BU05MC	Temperature	40±2℃	Humidity	90~95%	Applied current	Rated current	Duration	1000±24
	CM04RC · BU05MC															
Temperature	40±2℃															
Humidity	90~95%															
Applied current	Rated current															
Duration	1000±24															
23.High temperature life test	Inductance change : Within : ±10%		Refer to individual specification.			SMD inductor : Temperature : SMD inductor : 105±3℃ Duration : SMD inductor : 240±2hrs Recovery : At least 2 hrs of recvery under the standard condition after rhe removal from test chamber, followed by the measurement within 24 hrs. Commom mode choke coil : <table border="1"> <tr> <td></td> <td>CM04RC · BU05MC</td> </tr> <tr> <td>Temperature</td> <td>85±2℃</td> </tr> <tr> <td>Duration</td> <td>1000±24</td> </tr> </table> Recovery : 1~2 hrs of recovery under the standard condition after the removed from test chamber		CM04RC · BU05MC	Temperature	85±2℃	Duration	1000±24				
	CM04RC · BU05MC															
Temperature	85±2℃															
Duration	1000±24															
24.Low Temperature life Test	Inductance change : Within : ±10%		Refer to individual specification.			SMD inductor : Temperature : -40±3℃ Duration : SMD inductor : 240±2hrs Recovery : At least 2 hrs of recvery under the standard condition after rhe removal from test chamber, followed by the measurement within 24 hrs. Commom mode choke coil : <table border="1"> <tr> <td></td> <td>CM04RC · BU05MC</td> </tr> <tr> <td>Temperature</td> <td>-40±3℃</td> </tr> <tr> <td>Duration</td> <td>1000±24</td> </tr> </table> Recovery : 1~2 hrs of recovery under the standard condition after the removed from test chamber		CM04RC · BU05MC	Temperature	-40±3℃	Duration	1000±24				
	CM04RC · BU05MC															
Temperature	-40±3℃															
Duration	1000±24															