



The VVC1 Voltage Controlled Crystal Oscillator

Features

- VCXO with a CMOS output
- Small 5.0 X 7.0 X 1.9 mm package
- Output frequencies to 66 MHz
- 5.0 or 3.3 V operation
- Low Jitter < 6 pS rms, $f_o > 12\text{MHz}$
- Tri-State Output for test and board debug
- 0/70 or -40/85 °C operating temperature
- Hermetically sealed ceramic SMD package
- Lead free construction

- Product is compliant to RoHS directive  and fully compatible with lead free assembly

Applications

- SONET/SDH/DWDM
- Ethernet, Gigabit Ethernet
- xDSL/PCMCIA cards
- Digital Video
- Broadband Access

Description

Vectron's VVC1/VVC2 Voltage Controlled Crystal Oscillator (VCXO) is a quartz stabilized square wave generator with a CMOS output and is tested at CMOS and TTL (5.0 volt operation) logic levels.

The VVC1/VVC2 uses fundamental crystals resulting in low jitter performance and a monolithic IC which improves reliability and reduces cost.

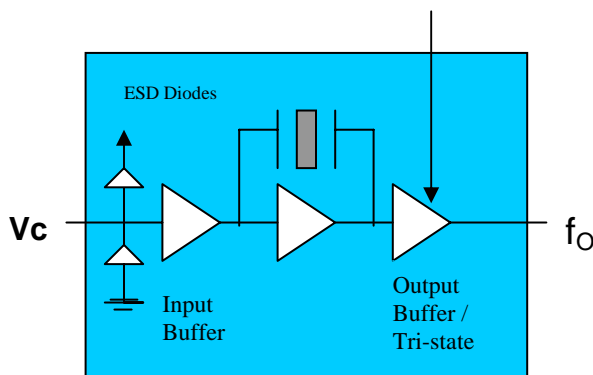

VVC1, VVC2 Voltage Controlled Crystal Oscillator

Performance Characteristics

Table 1. Electrical Performance					
Parameter	Symbol	Min	Typical	Maximum	Units
Frequency	f_O	1.544		65.536	MHz
Supply Voltage ¹ (+5.0 V \pm 5%) (+3.3 V \pm 5%)	V_{DD}	4.750 3.135	5.0 3.3	5.250 3.465	V
Supply Current (+5.0 V) (+3.3 V)	I_{DD}			55 40	mA
Output Logic Levels Output Logic High ² Output Logic Low ²	V_{OH} V_{OL}	0.9* V_{DD}		0.1 V_{DD}	V V
Transition Times Rise Time ² Fall Time ²	t_R t_F			5 5	ns ns
Symmetry or Duty Cycle ³	SYM	45	50	55	%
Operating temperature (<i>ordering option</i>)		0/70 or -40/85			°C
Total Pull Range (<i>ordering option</i>) Or Absolute Pull Range		± 50 , ± 100 or ± 150 ± 50 , ± 80 or ± 100			ppm
Test Conditions for APR (+5V option)	V_C	0.5		4.5	V
Test Conditions for APR (+3.3V option)	V_C	0.3		3.0	V
Gain Transfer (See Figure 3)		Positive			ppm/V
Control Voltage Impedance			90		Kohm
Control Voltage Bandwidth (-3dB)	BW	10			kHz
Package Size		5.0 x 7.0 x 1.9			mm

1. A 0.01 μ F and a 0.1 μ F capacitor should be located as close to the supply as possible (to ground) is recommended.
2. Figure 1 defines these parameters. Figure 2 illustrates the equivalent five gate TTL load and operating conditions under which these parameters are tested and specified.
3. Symmetry is defined as (ON TIME/PERIOD with $V_S = 1.4$ V for TTL and $V_S = 2.5$ V for CMOS, 5 volt operation, and $V_S = 1.65$ V for 3.3 Volt operation.

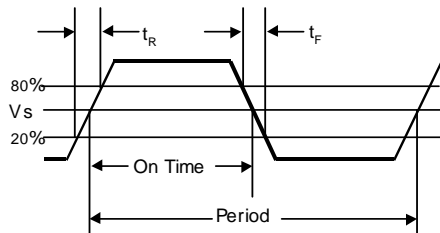

Figure 1. Output Waveform

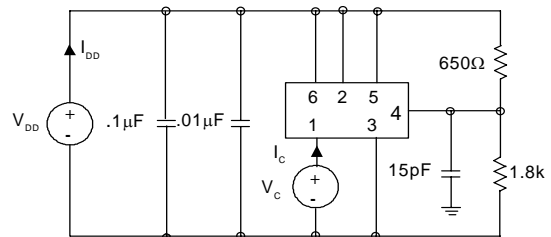
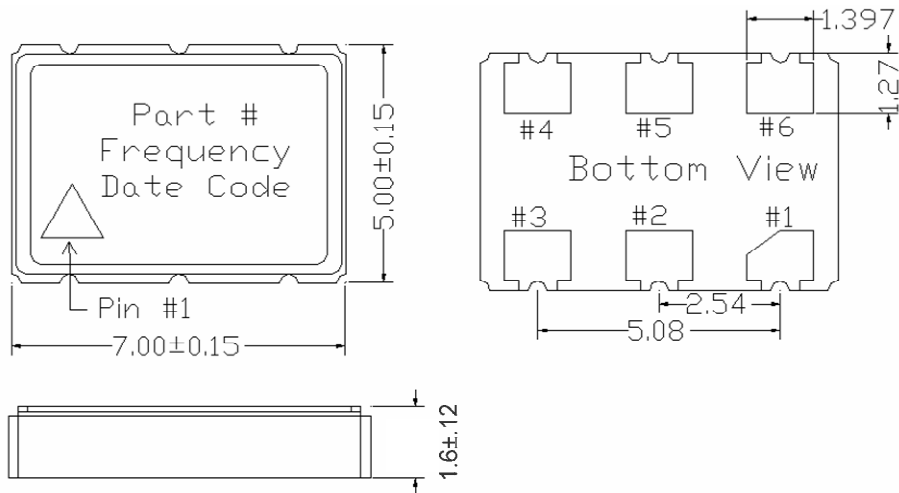

Figure 2. Typical Output Test Conditions (25 \pm 5°C)

VVC1, VVC2 Voltage Controlled Crystal Oscillator

Outline Diagram, Pad Layout and Pin Out

Primary Package



Alternate Package

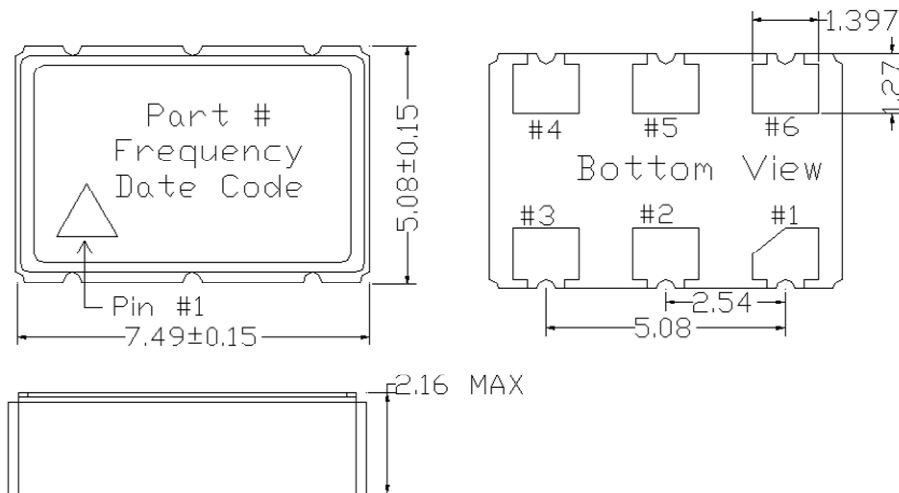

Pin #	Symbol	Function
1	V_C	Control Voltage
2	NC or Tri-state	No Connect or Tri-state
3	GND	Ground
4	f_o	Output Frequency
5	Tri-state or NC	Logic low disables output Logic high or no connection enables output waveform
6	V_{DD}	Supply Voltage

VVC1, VVC2 Voltage Controlled Crystal Oscillator

Tape and Reel

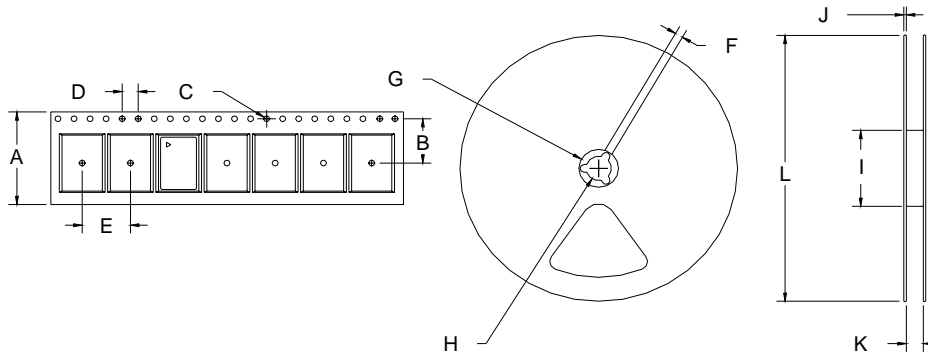

Table 2. Tape and Reel Dimensions (mm)

Tape Dimensions					Reel Dimensions							# Per Reel	
Product	A	B	C	D	E	F	G	H	I	J	K	L	Reel
VVC1/2	16	7.5	1.5	4	8	2	21	13	60	2	17	180	1000

Absolute Maximum Ratings

Stresses in excess of the absolute maximum ratings can permanently damage the device. Functional operation is not implied at these or any other conditions in excess of conditions represented in the operational sections of this data sheet. Exposure to absolute maximum ratings for extended periods may adversely affect device reliability.

Table 3. Absolute Maximum Ratings

Parameter	Symbol	Ratings	Unit
Power Supply	V_{DD}	6	Vdc
Storage Temperature	$T_{storage}$	-55/125	°C
Voltage Control Range	V_C	Gnd to V_{DD}	V

VVC1, VVC2 Voltage Controlled Crystal Oscillator

Reliability

The VVC1/VVC2 is capable of meeting the following qualification tests.

Table 4. Environmental Compliance	
Parameter	Conditions
Mechanical Shock	MIL-STD-883 Method 2002
Mechanical Vibration	MIL-STD-883 Method 2007
Solderability	MIL-STD-883 Method 2003
Gross and Fine Leak	MIL-STD-883 Method 1014
Resistance to Solvents	MIL-STD-883 Method 2016
Moisture Sensitivity Level	1

Handling Precautions

Although ESD protection circuitry has been designed into the the VVC1/VVC2, proper precautions should be taken when handling and mounting. VI employs a Human Body Model and a Charged-Device Model (CDM) for ESD susceptibility testing and design protection evaluation. ESD thresholds are dependent on the circuit parameters used to define the model. Although no industry wide standard has been adopted for the CDM, a standard HBM of resistance = 1.5kohms and capacitance = 100pF is widely used and therefore can be used for comparison purposes.

Table 5. ESD Ratings		
Model	Minimum	Conditions
Human Body Model	1500	MIL-STD-883 Method 3115
Charged Device Model	1000	JESD 22-C101

Suggested IR profile

Devices are built using lead free epoxy and can also be subjected to standard lead free IR reflow conditions.

Table 6. Reflow Profile (IPC/JEDEC J-STD-020)		
Parameter	Symbol	Value
PreHeat Time	t_s	60 sec Min, 200 sec Max
Ramp Up	R_{UP}	3 °C/sec Max
Time Above 217 °C	t_L	60 sec Min, 150 sec Max
Time To Peak Temperature	t_{AMB-P}	480 sec Max
Time At 260 °C (max)	t_P	20 sec Min, 40 sec Max
Time At 240°C (max)	$tp2$	60 sec MAX
Ramp Down	R_{DN}	6 °C/sec Max

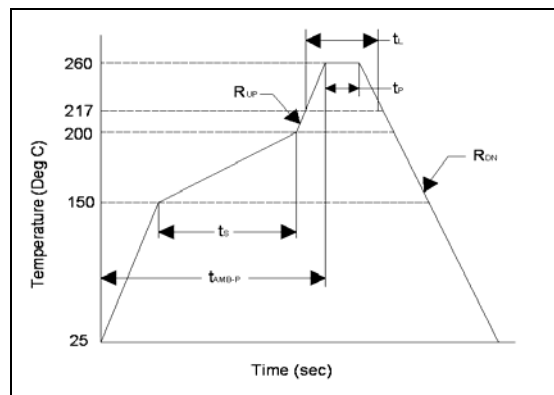

VVC1, VVC2 Voltage Controlled Crystal Oscillator

Table 7. Standard Frequencies (MHz)

1.544	2.048	4.096	8.192	10.000
12.000	12.288	12.352	13.000	14.318
15.440	16.000	16.384	18.432	19.440
20.000	20.480	24.576	24.704	27.000
30.000	32.000	32.768	34.368	35.328
38.880	40.000	40.960	44.736	51.840
52.000	62.208	65.536		

Other frequencies may be available upon request. Standard frequencies are frequencies which the crystal has been designed and does not imply a stock position.

Ordering Information

VVC1-BGE - xxMxxx

Product Family
VV = VCXO

Package
5x7x1.9

Tristate
1= Pin 5
2= Pin 2

Power Supply, Linearity
A= 5.0V, 20% Linearity
B= 3.3V, 20% Linearity
C= 5.0V, 10% Linearity
D= 3.3V, 10% Linearity

Frequency
ex.: 44M736 = 44.736MHz

Temperature Range, Stability (for TPR)
B= 0/70°C, ±50 ppm
D= -40/85°C, ±50 ppm
E= 0/70°C, ±25 ppm
F= -40/85°C, ±25 ppm

Absolute Pull Range
G= ±50 ppm APR
N= ±80 ppm APR
H= ±100 ppm APR

or Total Pull Range
1= ±50 ppm
2= ±100 ppm
3= ±150 ppm

NOTE: Not all combinations of options are available. Higher frequencies have less pull capability, especially at +3.3 volts supply, and higher pull can result in 20% linearity instead of 10%. Consult factory or your local sales representative with application requirements.

For Additional Information, Please Contact:



USA: Vectron International • 267 Lowell Road, Hudson, NH 03051
• Tel: 1-88-VECTRON-1 • Fax: 1-888-FAX-VECTRON
EUROPE: Landstrasse, D-74924, Neckarbischofsheim, Germany •
Tel: 49 (0) 7268 8010 • Fax: 49 (0) 7268 801281
ASIA: Vectron Asia Pacific Sales 1F~2F, No.8 Workshop No.308 Fenju Rd.,
WaiGaoQiao Free Trade Zone, Pudong New Area Shanghai, China 200131
•Tel: 8621 50480777 • Fax: 8621 50481881

www.vectron.com

Vectron International reserves the right to make changes to the product(s) and/or information contained herein without notice. No liability is assumed as a result of their use or application. No rights under any patent accompany the sale of any such product(s) or information. VVC1 (October 4, 2006)