

Peaking Coils

Series: **Axial**
 Type: **A, M, P, X**

Japan

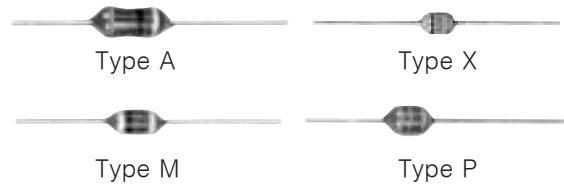

■ Features

- Compact size, with high Q and self resonant-frequency
- Wide inductance range (0.22 μH to 1000 μH)

■ Recommended Applications

- CTV, VCR, Audio, PC, Facsimiles

■ Performance Characteristics



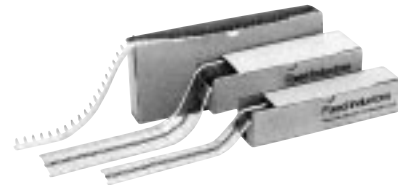

- Operating Temperature $-20\text{ }^{\circ}\text{C}$ to $+80\text{ }^{\circ}\text{C}$
- Temperature Rise20 K ($20\text{ }^{\circ}\text{C}$) max.
- Terminal Strength24.5 N min.

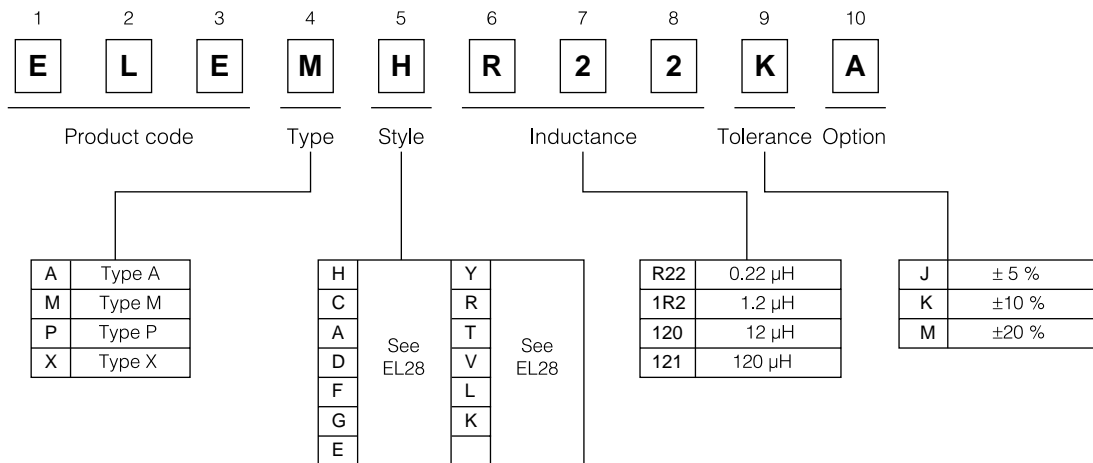

■ Explanation of Part Numbers



■ Performance Specifications, Summary

Type	Size (mm)	Features	Inductance Range (μH)
A	φ5.0×10.5 (D×L)	<ul style="list-style-type: none"> ● Wide inductance range ● Large allowable DC current ● Axial taping mount pitch : 12.5 mm min. 	 <p>0.22 ————— 1000 (μH)</p>
M	φ3.0×7.5	<ul style="list-style-type: none"> ● Compact size ● Axial taping mount pitch : 10.0 mm min. 	 <p>0.22 ————— 820 (μH)</p>
P	φ4.2×6.5	<ul style="list-style-type: none"> ● Compact size and wide inductance range ● Capable of automatic inserting at 5 mm pitch (forming into radial structure) ● Axial taping mount pitch : 7.5 mm min. 	 <p>0.22 ————— 1000 (μH)</p>
X	φ2.3×3.4	<ul style="list-style-type: none"> ● Small size ● Suitable for small signal processing circuits ● Axial taping mount pitch : 5.0 mm min. 	 <p>0.22 ————— 220 (μH)</p>

Examples : Types A, M

Part No.	Inductance (μH)	Tolerance		Test Frequency (MHz)	Type A				Type M						
		Standard	Special		Q min.	SRF (MHz) min.	DCR** (Ω) max.	DC Current (mA)	Q min.	SRF (MHz) min.	DCR** (Ω) max.	DC Current (mA)			
ELE□□R22MA	0.22	±20 %	Special	25.2	45	300	0.09	1400	35	150	0.20	400			
ELE□□R27MA	0.27				45	270	0.10	1320	35	150	0.22	380			
ELE□□R33MA	0.33				45	250	0.11	1280	35	150	0.24	370			
ELE□□R39MA	0.39				45	230	0.12	1200	35	150	0.26	350			
ELE□□R47MA	0.47				45	220	0.13	1150	35	150	0.28	330			
ELE□□R56MA	0.56				45	200	0.14	1100	35	150	0.31	320			
ELE□□R68MA	0.68				45	190	0.15	1030	35	150	0.34	310			
ELE□□R82□A	0.82				±10 %	Special	25.2	45	172	0.17	980	35	150	0.37	290
ELE□□R10□A	1.0							45	157	0.19	920	35	150	0.40	270
ELE□□R2□A	1.2							50	144	0.21	880	40	144	0.45	260
ELE□□R5□A	1.5	50	131	0.23				830	40	131	0.50	250			
ELE□□R8□A	1.8	55	121	0.25				790	40	120	0.55	240			
ELE□□2R2□A	2.2	55	90	0.28				750	40	100	0.60	230			
ELE□□2R7□A	2.7	60	80	0.30				720	40	90	0.65	220			
ELE□□3R3□A	3.3	±10 %	Special	7.96				65	70	0.34	670	40	80	0.75	210
ELE□□3R9□A	3.9							65	50	0.37	640	40	65	0.80	200
ELE□□4R7□A	4.7							70	40	0.39	620	40	50	0.90	190
ELE□□5R6□A	5.6				70	33	0.43	590	40	30	0.95	180			
ELE□□6R8□A	6.8				70	27	0.48	550	40	27	1.1	175			
ELE□□8R2□A	8.2				65	25	0.52	530	40	25	1.2	165			
ELE□□100□A	10				60	22	0.58	500	40	20	1.3	160			
ELE□□120□A	12				±10 %	Special	2.52	60	17	0.63	480	40	18	1.5	150
ELE□□150□A	15							60	11	0.72	460	40	16	1.7	145
ELE□□180□A	18							65	10	0.77	430	40	12	1.8	140
ELE□□220□A	22	65	9.0	0.84				410	40	10	2.0	130			
ELE□□270□A	27	65	7.6	0.94				390	40	9.0	2.3	125			
ELE□□330□A	33	55	6.3	1.03				370	40	8.0	2.4	120			
ELE□□390□A	39	50	6.3	1.12				350	40	7.5	2.7	115			
ELE□□470□A	47	45	6.3	1.22				340	40	7.0	3.0	110			
ELE□□560□A	56	40	6.2	1.34				320	40	6.5	3.3	105			
ELE□□680□A	68	40	5.7	1.47				305	40	6.0	3.8	100			
ELE□□820□A	82	35	5.3	1.62	290	40	5.3	4.5	95						
ELE□□101□A	100	30	4.8	1.80	275	40	4.8	5.0	90						
ELE□□121□A	120	±5 %	Special	0.796	70	3.8	3.70	185	40	3.8	6.0	90			
ELE□□151□A	150				70	3.5	4.20	175	40	3.5	7.0	85			
ELE□□181□A	180				65	3.3	4.60	165	40	3.3	8.0	80			
ELE□□221□A	220				70	3.0	5.10	155	40	3.0	9.0	75			
ELE□□271□A	270				65	2.80	5.80	145	50	2.8	11	64			
ELE□□331□A	330				70	2.60	6.40	137	50	2.6	13	60			
ELE□□391□A	390				70	2.40	7.00	133	50	2.4	15	56			
ELE□□471□A	470				60	2.25	7.70	126	50	2.1	21	50			
ELE□□561□A	560				60	2.10	8.50	120	50	2.0	24	47			
ELE□□681□A	680				55	1.95	9.40	113	50	1.8	27	43			
ELE□□821□A	820	55	1.85	10.5	105	50	1.7	30	41						
ELE□□102□A	1000	50	1.40	14.0	100										

Design, Specifications are subject to change without notice. Ask factory for technical specifications before purchase and/or use. Whenever a doubt about safety arises from this product, please inform us immediately for technical consultation without fail.

Examples : Types P, X







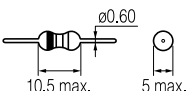
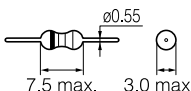
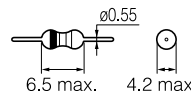
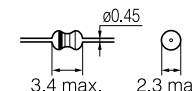

Inductance (μ H)	Type P				Type X				* Color Code		
	Q min.	SRF (MHz) min.	DCR** (Ω) max.	DC Current (mA)	Q min.	SRF (MHz) min.	DCR** (Ω) max.	DC Current (mA)	1st	2nd	3rd
0.22	25	150	0.20	400	35	150	0.40	400	R	R	S
0.27	25	150	0.22	380	35	150	0.43	380	R	V	S
0.33	25	150	0.24	370	35	150	0.48	370	O	O	S
0.39	25	150	0.26	350	35	150	0.51	350	O	W	S
0.47	25	150	0.28	330	35	150	0.56	330	Y	V	S
0.56	25	150	0.31	320	35	150	0.61	320	Gn	Be	S
0.68	25	120	0.34	310	35	150	0.67	310	Be	Gy	S
0.82	35	120	0.37	290	35	150	0.74	290	Gy	R	S
1.0	35	100	0.40	270	35	150	0.80	270	Bn	Bk	Gd
1.2	40	85	0.45	260	40	110	0.90	260	Bn	R	Gd
1.5	40	70	0.50	250	40	80	1.0	250	Bn	Gn	Gd
1.8	40	60	0.55	240	40	60	1.1	240	Bn	Gy	Gd
2.2	40	55	0.60	230	40	45	1.2	230	R	R	Gd
2.7	40	50	0.65	220	40	40	1.3	220	R	V	Gd
3.3	40	45	0.75	210	40	38	1.4	210	O	O	Gd
3.9	40	40	0.80	200	40	35	1.6	200	O	W	Gd
4.7	40	35	0.90	190	40	32	1.7	190	Y	V	Gd
5.6	40	33	0.95	180	40	30	1.9	180	Gn	Be	Gd
6.8	40	27	1.1	175	40	28	2.0	175	Be	Gy	Gd
8.2	40	25	1.2	165	40	26	2.2	165	Gy	R	Gd
10	40	23	1.3	160	40	24	2.5	160	Bn	Bk	Bk
12	40	20	1.5	150	40	22	2.5	150	Bn	R	Bk
15	40	16	1.7	145	40	20	2.8	145	Bn	Gn	Bk
18	40	12	1.8	140	40	18	3.1	140	Bn	Gy	Bk
22	40	10	2.0	130	40	17	3.4	130	R	R	Bk
27	40	9.0	2.3	125	40	16	4.3	80	R	V	Bk
33	40	8.0	2.4	120	40	14	4.7	76	O	O	Bk
39	40	7.5	2.7	115	40	13	5.2	74	O	W	Bk
47	40	7.0	3.0	110	40	12	5.8	70	Y	V	Bk
56	40	6.5	3.3	105	40	11	8.0	52	Gn	Be	Bk
68	40	6.0	3.8	100	40	10	10	49	Be	Gy	Bk
82	40	5.3	4.5	95	40	9.5	11	46	Gy	R	Bk
100	40	4.8	5.0	90	40	9.0	12	44	Bn	Bk	Bn
120	50	3.8	6.0	90	40	7.0	14	41	Bn	R	Bn
150	50	3.5	7.0	85	40	6.0	16	39	Bn	Gn	Bn
180	50	3.3	8.0	80	40	5.5	18	37	Bn	Gy	Bn
220	50	3.0	9.0	75	40	5.0	20	35	R	R	Bn
270	50	2.7	10	70					R	V	Bn
330	50	2.5	12	64					O	O	Bn
390	50	2.4	14	59					O	W	Bn
470	50	2.2	16	55					Y	V	Bn
560	50	2.1	20	50					Gn	Be	Bn
680	50	2.0	22	47					Be	Gy	Bn
820	50	1.9	25	44					Gy	R	Bn
1000	40	1.8	30	40					Bn	Bk	R

* Color Code

Bk =Black
 Bn =Brown
 R =Red
 O =Orange
 Y =Yellow
 Gn =Green
 Be =Blue
 V =Violet
 Gy =Gray
 W =White
 Gd =Gold
 S =Silver

** DC Resistance

■ Dimensions in mm (not to scale)

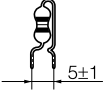
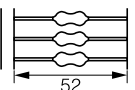
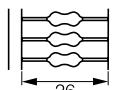
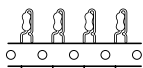
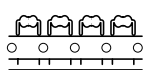
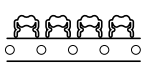
Type		Type A	Type M	Type P	Type X	
						
Style						
Lead Forming	H		Yes	Yes	Yes	Yes
	C		Yes			
	A		Yes			
	D			Yes		
	F			Yes	Yes	
	G					Yes
	E				Yes	
	Y		Yes			
Taping	R		Yes	Yes	Yes	Yes
	T		Yes	Yes	Yes	Yes
	V		Yes			
	L				Yes	Yes
	K				Yes	

Design, Specifications are subject to change without notice. Ask factory for technical specifications before purchase and/or use. Whenever a doubt about safety arises from this product, please inform us immediately for technical consultation without fail.

Color Code

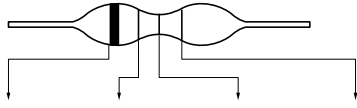

Color	Color Bands			
	1st figure	2nd figure	Multiplier	Tolerance
Black	0		10^0	$\pm 20\%$
Brown	1		10^1	—
Red	2		10^2	—
Orange	3		10^3	—
Yellow	4		—	—
Green	5		—	—
Blue	6		—	—
Violet	7		—	—
Gray	8		—	—
White	9		—	—
Gold	—		10^{-1}	$\pm 5\%$
Silver	—		10^{-2}	$\pm 10\%$

Tape Dimensions in mm (not to scale)

● Style R & T

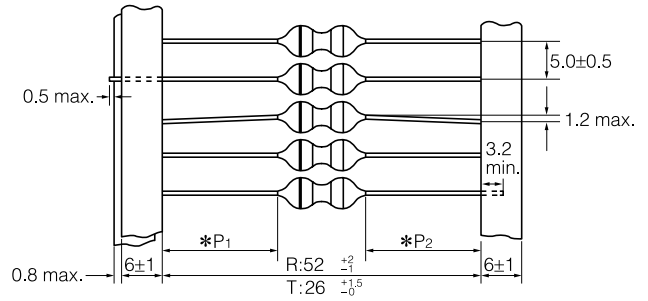

* $|P_1 - P_2| \leq 1.0$

Note : Axial Taping Mount Pitch

A..... 12.5 min.

M..... 10.0 min.

P..... 7.5 min.

X..... 5.0 min.

Tape Dimensions in mm (not to scale)

● Style V

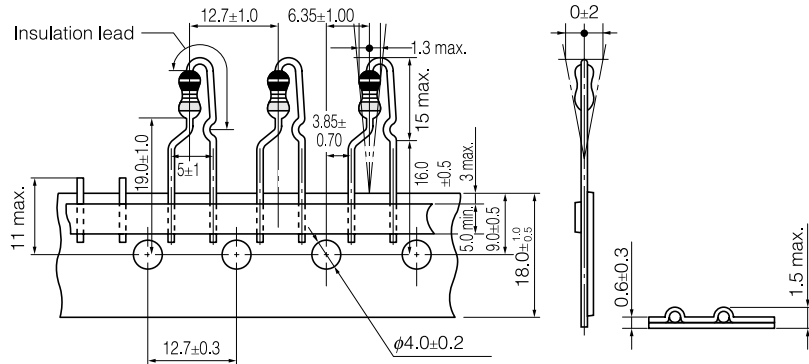

● Style K

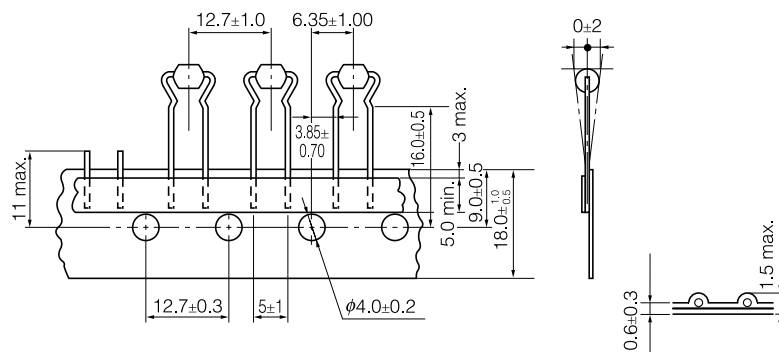

● Style L

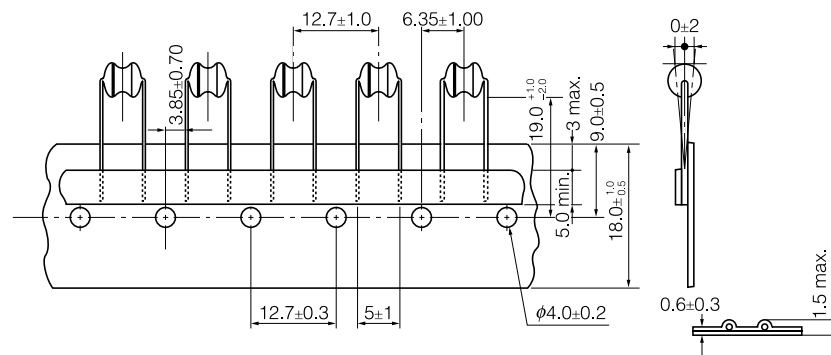

Peaking Coils

Series: **Radial**
 Type: **S, L, K**

Japan

Type S

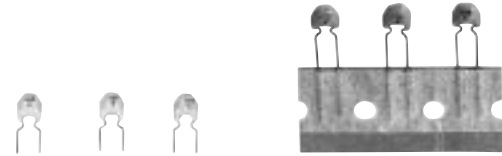

Taped

Type L

Type K



■ Features

- Compact size, with high Q and self-resonant frequency
- Wide inductance range: 0.22 μH to 22 mH

■ Recommended Applications

- CTV, VTR, Audio, PC, Facsimiles

■ Performance Characteristics

- Operating Temperature $-20\text{ }^{\circ}\text{C}$ to $+80\text{ }^{\circ}\text{C}$
- Temperature Rise 20 K ($20\text{ }^{\circ}\text{C}$) max.
- Terminal Strength 4.9 N min.

■ Explanation of Part Numbers

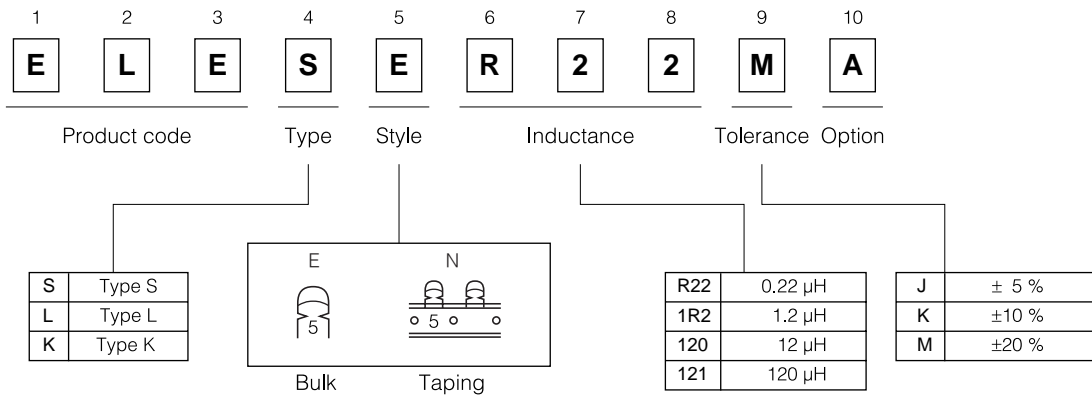

■ Marking

	Value	Marking
Inductance	0.22 μH	R22
	1.2 μH	1R2
	12 μH	120
	120 μH	121
Inductance Tolerance	$\pm 5\%$	J
	$\pm 10\%$	K
	$\pm 20\%$	M

Examples : Type S

Part No.	Inductance (μH)	Inductance Tolerance		Q min.	Test Frequency	SRF (MHz) min.	DCR* (Ω) max.	DC Current (mA)
		Standard	Special					
		Type S						
ELES□R22MA	0.22	±20 %		35	25.2 MHz	150	0.15	800
ELES□R27MA	0.27			35		150	0.16	800
ELES□R33MA	0.33			35		150	0.17	800
ELES□R39MA	0.39			35		130	0.19	800
ELES□R47MA	0.47			35		130	0.20	800
ELES□R56MA	0.56			35		130	0.22	700
ELES□R68MA	0.68			35		120	0.24	700
ELES□R82MA	0.82			35		120	0.26	700
ELES□1R0□A	1.0			±10 %			35	7.96 MHz
ELES□1R2□A	1.2	50	75		0.32		645	
ELES□1R5□A	1.5	50	65		0.34		608	
ELES□1R8□A	1.8	50	55		0.37		577	
ELES□2R2□A	2.2	50	50		0.40		550	
ELES□2R7□A	2.7	50	45		0.44		520	
ELES□3R3□A	3.3	50	40		0.49		488	
ELES□3R9□A	3.9	50	35		0.53		466	
ELES□4R7□A	4.7	50	30		0.58		434	
ELES□5R6□A	5.6	±10 %	±5 %	50	2.52 MHz	27	0.64	422
ELES□6R8□A	6.8			50		25	0.70	398
ELES□8R2□A	8.2			50		22	0.77	378
ELES□100□A	10			50		20	0.84	353
ELES□120□A	12			50		18	1.03	339
ELES□150□A	15			50		15	1.15	316
ELES□180□A	18			50		12	1.26	301
ELES□220□A	22			50		11	1.40	272
ELES□270□A	27			50		10	1.58	254
ELES□330□A	33	±10 %	±5 %	40	796 kHz	9.5	1.79	239
ELES□390□A	39			40		9.0	1.99	223
ELES□470□A	47			40		8.5	2.25	213
ELES□560□A	56			40		8.0	2.52	204
ELES□680□A	68			40		7.5	2.87	174
ELES□820□A	82			40		7.0	3.23	164
ELES□101□A	100			40		6.5	3.64	150
ELES□121□A	120			50		6.2	4.3	140
ELES□151□A	150			50		5.7	5.0	130
ELES□181□A	180	50	5.3	5.7	120			
ELES□221□A	220	±10 %	±5 %	50		4.0	6.5	112
ELES□271□A	270			50		3.6	8.0	90
ELES□331□A	330			50		3.3	11.0	87
ELES□391□A	390			50		3.0	12.0	80
ELES□471□A	470			50		2.8	14.0	76
ELES□561□A	560			50		2.4	20.0	69
ELES□681□A	680			50		2.2	22.5	65
ELES□821□A	820			50		2.0	25.5	61
ELES□102□A	1000			50		1.8	29.5	56

Dimensions in mm (not to scale)

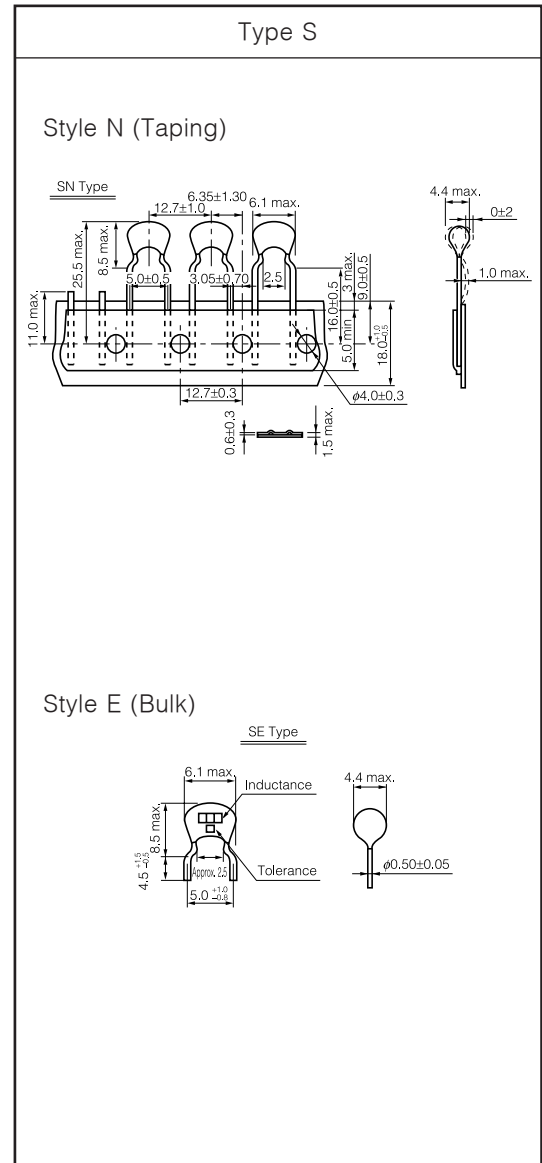

*DC Resistance

Examples : Type L, K

Part No.	Inductance (μH)	Type L							Type K									
		Inductance Tolerance		Q min.	Test Frequency	SRF (MHz) min.	DCR* (Ω) max.	DC Current (mA)	Inductance Tolerance		Q min.	Test Frequency	SRF (MHz) min.	DCR* (Ω) max.	DC Current (mA)			
		Standard	Special						Standard	Special								
ELE□□1R0□□A	1.0	±20 %	±10 %	—	7.96 MHz	68	0.05	1600	±20 %	±10 %	—	—	37	0.048	2400			
ELE□□1R5□□A	1.5					60	0.06	1500								27	0.048	2200
ELE□□2R2□□A	2.2					52	0.07	1400								22	0.048	2000
ELE□□3R3□□A	3.3					45	0.08	1300								15.6	0.048	1740
ELE□□4R7□□A	4.7					32	0.10	1200								14.2	0.052	1670
ELE□□6R8□□A	6.8					25	0.12	1100								12.7	0.059	1590
ELE□□100□□A	10	±10 %	±5 %	20	2.52 MHz	19	0.14	1000	±10 %	±5 %	13	10 kHz	15.6	0.048	1740			
ELE□□120□□A	12			20		17	0.15	920			14		14.2	0.052	1670			
ELE□□150□□A	15			20		16	0.17	850			15		12.7	0.059	1590			
ELE□□180□□A	18			15		14	0.20	770			16		11.6	0.066	1520			
ELE□□220□□A	22			15		13	0.22	730			17		10.4	0.074	1440			
ELE□□270□□A	27			15		12	0.25	650			18		9.40	0.083	1360			
ELE□□330□□A	33			15		10	0.30	600			19		8.20	0.094	1290			
ELE□□390□□A	39			15		9.2	0.35	550			19		7.40	0.105	1220			
ELE□□470□□A	47			15		8.5	0.40	500			20		6.60	0.118	1120			
ELE□□560□□A	56			15		7.7	0.57	460			20		5.90	0.133	1020			
ELE□□680□□A	68			15		7.0	0.65	420			21		5.30	0.177	920			
ELE□□820□□A	82			15		6.4	0.74	380			20		4.30	0.204	850			
ELE□□101□□A	100			25		5.5	0.90	350			20		4.00	0.236	790			
ELE□□121□□A	120			25		5.3	1.0	320			21		3.80	0.267	730			
ELE□□151□□A	150			25		4.7	1.5	300			19		2.95	0.370	630			
ELE□□181□□A	180			30		4.3	1.8	270			20		2.72	0.430	580			
ELE□□221□□A	220			30		4.0	2.0	250			21		2.49	0.500	530			
ELE□□271□□A	270			30		3.3	2.6	220			21		2.27	0.580	490			
ELE□□331□□A	330			35	3.0	3.3	195	18			1.92	0.830	420					
ELE□□391□□A	390			35	2.8	3.8	180	19			1.77	0.960	398					
ELE□□471□□A	470			35	2.3	5.0	160	19			1.60	1.10	368					
ELE□□561□□A	560			40	2.2	6.0	150	20			1.46	1.26	339					
ELE□□681□□A	680			40	2.0	7.0	140	16			1.26	2.03	288					
ELE□□821□□A	820			40	1.9	8.0	125	17			1.17	2.28	268					
ELE□□102□□A	1000			45	1.7	10	115	17			1.08	2.61	248					
ELE□□122□□A	1200			45	1.6	12	100	18			1.01	2.98	229					
ELE□□152□□A	1500			45	1.4	15	90	19			0.930	3.50	208					
ELE□□182□□A	1800			45	1.3	20	80	19			0.860	4.10	192					
ELE□□222□□A	2200			45	1.2	23	74	17			0.700	5.80	164					
ELE□□272□□A	2700			40	1.1	30	65	18			0.620	6.80	147					
ELE□□332□□A	3300			40	1.0	37	60	19			0.550	7.80	130					
ELE□□392□□A	3900			40	0.90	42	55	20			0.500	8.70	119					
ELE□□472□□A	4700			40	0.85	50	50	18			0.430	12.4	109					
ELE□□562□□A	5600			40	0.78	60	45	18			0.390	14.1	103					
ELE□□682□□A	6800	40	0.70	80	40	19	0.350	16.3	96									
ELE□□822□□A	8200	40	0.60	95	37	20	0.310	18.7	90									
ELE□□103□□A	10000	25	0.57	110	34	17	0.291	28.8	73									
ELE□□123□□A	12000	25	0.55	130	30	18	0.260	32.0	68									
ELE□□153□□A	15000	25	0.51	170	27	19	0.227	38.0	62									
ELE□□183□□A	18000								20		0.203	44.0	57					
ELE□□223□□A	22000								21		0.179	51.0	51					

■ Dimensions in mm (not to scale)

- Style E (Bulk)

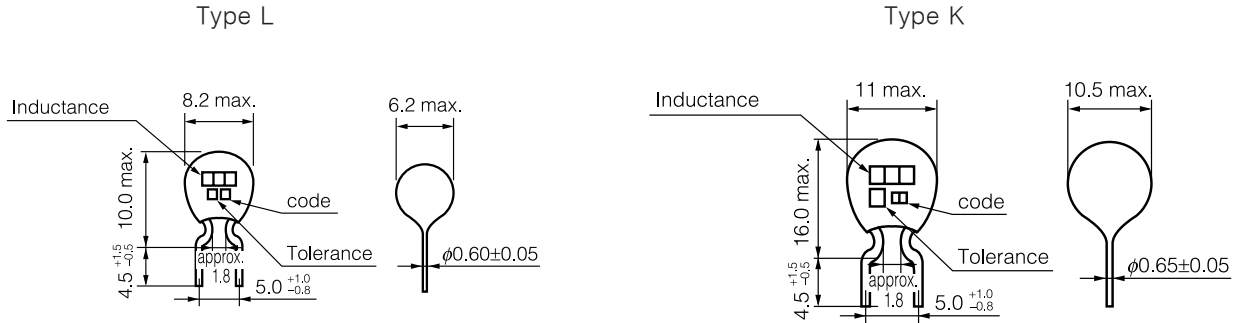

- Style N (Taping)

