

Subminiature, Leaded Solid Tantalum Capacitors Polar or Non-Polar



ELECTRICAL CHARACTERISTICS

Operating Temperature Range: - 55 °C to + 125 °C

Capacitance: Measured at 120 Hz and 25 °C with a maximum of 2.2 V_{DC} bias and 1.0 V_{RMS} signal.

Capacitance Tolerance: Standard tolerance is ± 20 % for ratings 0.1 µF and above, and + 40 % - 20 % for ratings below 0.1 µF. Special tolerances are also available.

Dissipation Factor: When measured simultaneously with capacitance, DF shall not exceed the value shown in the Standard Ratings tables.

DC Leakage Current (DCL Max):

When measured with DC voltage applied through a 1000 Ω resistor for 5 min, DC leakage (µA) shall not exceed:

At 25 °C: Leakage current shall not exceed the values listed in the Standard Ratings tables.

At 85 °C: Leakage current shall not exceed 10 times the values listed in the Standard Ratings tables.

At 125 °C and 66 % of Rated Voltage: Leakage current shall not exceed 15 times the values listed in the Standard Ratings tables.

Operating Voltage: Full working voltage up to 85 °C. From 85 °C to 125 °C working voltage derates linearly to 66 % of the 85 °C working voltage.

FEATURES

- Subminiature package size and light weight
- Rectangular case with axial or radial leads
- 2 V_{DC} to 50 V_{DC}
- 0.1 µF to 470 µF
- Operating temperature range: - 55 °C to + 125 °C
- High stability and reliability
- Tested in accordance with MIL-PRF-49137
- Unique and comprehensive custom design capability

APPLICATIONS

- Hearing aids
- Portable communications
- Space/avionics
- Laptop computers

MECHANICAL SPECIFICATIONS

Solder coated nickel leads (type N32 per MIL-STD-1276) are standard on all case sizes.

Leads are weldable and/or solderable.

Special leads are available on request (e.g. bare nickel, gold plated nickel or ribbon leads).

Lead length is 1 1/2" [38.1 mm] minimum on non-polar parts.

On polar parts the negative lead is 1 1/4" [31.8 mm] minimum and the positive lead is 1 1/2" [38.1 mm] minimum.

ORDERING INFORMATION					
TC	1.0	35	C3	A⁽¹⁾	M
MODEL	CAPACITANCE (µF)	DC VOLTAGE RATING AT + 85 °C	CASE CODE	LEAD CONFIGURATION	CAPACITANCE TOLERANCE
			C = Polar N = Non-polar	A = Axial R = Radial	E = + 40 %, - 20 % M = ± 20 % K = ± 10 % J = ± 5 %
EXAMPLE OF PART NUMBER CODE: TC1.0-35C3AM					

Note

⁽¹⁾ To complete part number in rating tables, add A or R.
Change suffix if special capacitance tolerance is required.

DIMENSIONS in inches [millimeters]

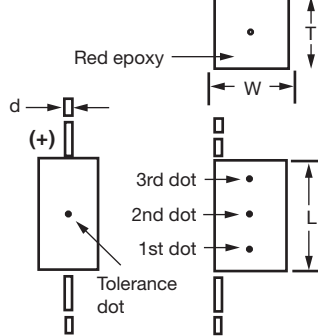
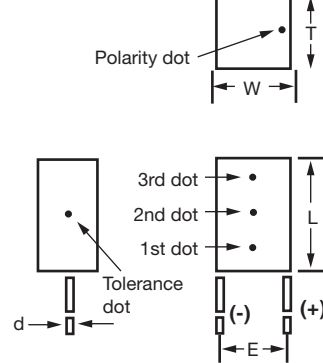
POLAR STYLE
Polar Style
Axial

Radial

The 3rd dot is on the end of the CX size

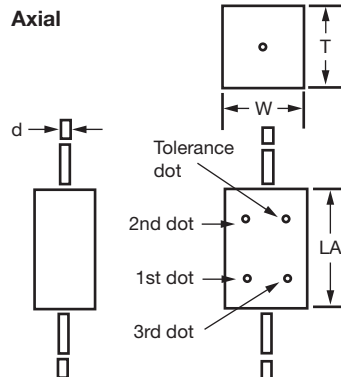
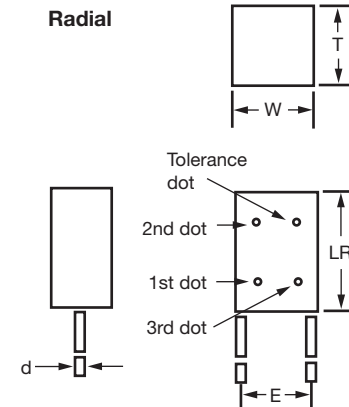
CASE CODE	L MAX.	W MAX.	T MAX.	E	E TOL. ±	d
CX	0.075 [1.91]	0.050 [1.27]	0.040 [1.02]	0.030 [0.76]	0.015 [0.38]	0.007 [0.18]
C0	0.100 [2.54]	0.050 [1.27]	0.040 [1.02]	0.030 [0.76]	0.015 [0.38]	0.007 [0.18]
C1	0.125 [3.18]	0.070 [1.78]	0.040 [1.02]	0.050 [1.27]	0.015 [0.38]	0.010 [0.25]
C2	0.165 [4.19]	0.120 [3.05]	0.070 [1.78]	0.100 [2.54]	0.020 [0.51]	0.010 [0.25]
C3	0.225 [5.72]	0.185 [4.70]	0.075 [1.91]	0.150 [3.81]	0.020 [0.51]	0.010 [0.25]
C4	0.290 [7.37]	0.220 [5.59]	0.110 [2.79]	0.180 [4.57]	0.025 [0.64]	0.016 [0.41]
C5	0.310 [7.87]	0.230 [5.84]	0.130 [3.30]	0.200 [5.08]	0.025 [0.64]	0.016 [0.41]
C6	0.475 [12.07]	0.375 [9.53]	0.150 [3.81]	0.300 [7.62]	0.025 [0.64]	0.016 [0.41]

NON POLAR STYLE
Non Polar Style
Axial

Radial

CASE CODE	LA MAX.	LR MAX.	W MAX.	T MAX.	E MAX.	E TOL. ±	d
N1	0.220 [5.59]	0.180 [4.57]	0.125 [3.18]	0.125 [3.18]	0.100 [2.54]	0.020 [0.51]	0.010 [0.25]
N2	0.280 [7.11]	0.240 [6.10]	0.140 [3.56]	0.180 [4.57]	0.100 [2.54]	0.025 [0.64]	0.010 [0.25]
N3	0.370 [9.40]	0.315 [8.00]	0.180 [4.57]	0.220 [5.59]	0.150 [3.81]	0.025 [0.64]	0.016 [0.41]
N4	0.390 [9.91]	0.335 [8.51]	0.230 [5.84]	0.230 [5.84]	0.180 [4.57]	0.025 [0.64]	0.016 [0.41]



STANDARD RATINGS - POLAR CAPACITORS				
CAPACITANCE (μ F)	MAX. DF (%)	MAX. DCL AT + 25 °C (μ A)	CASE CODE	PART NUMBER
2 V_{DC} AT + 85 °C				
0.47	10	0.5	C0	TC.47-2C0(1)M
0.68	10	0.5	C0	TC.68-2C0(1)M
1.0	10	0.5	C0	TC1.0-2C0(1)M
2.2	10	0.5	C1	TC2.2-2C1(1)M
10	10	0.5	C2	TC10-2C2(1)M
33	10	1.0	C3	TC33-2C3(1)M
100	15	2.0	C4	TC100-2C4(1)M
150	15	3.0	C5	TC150-2C5(1)M
470	20	9.0	C6	TC470-2C6(1)M
3 V_{DC} AT + 85 °C				
1.5	10	0.5	C1	TC1.5-3C1(1)M
6.8	10	0.5	C2	TC6.8-3C2(1)M
22	10	1.0	C3	TC22-3C3(1)M
68	10	2.0	C4	TC68-3C4(1)M
100	10	3.0	C5	TC100-3C5(1)M
330	20	9.0	C6	TC330-3C6(1)M
4 V_{DC} AT + 85 °C				
0.33	10	0.5	C0	TC.33-4C0(1)M
1.0	8	0.5	C1	TC1.0-4C1(1)M
4.7	8	0.5	C2	TC4.7-4C2(1)M
15	8	1.0	C3	TC15-4C3(1)M
47	8	2.0	C4	TC47-4C4(1)M
68	8	3.0	C5	TC68-4C5(1)M
220	15	9.0	C6	TC220-4C6(1)M
6 V_{DC} AT + 85 °C				
0.22	10	0.5	C0	TC.22-6C0(1)M
0.68	6	0.5	C1	TC.68-6C1(1)M
3.3	6	0.5	C2	TC3.3-6C2(1)M
10	6	1.0	C3	TC10-6C3(1)M
33	6	2.0	C4	TC33-6C4(1)M
47	6	3.0	C5	TC47-6C5(1)M
150	10	9.0	C6	TC150-6C6(1)M
10 V_{DC} AT + 85 °C				
0.0010	10	0.5	C0	TC.0010-10C0(1)E
0.0010	10	0.5	C1	TC.0010-10C1(1)E
0.0015	10	0.5	C0	TC.0015-10C0(1)E
0.0015	10	0.5	C1	TC.0015-10C1(1)E
0.0022	10	0.5	C0	TC.0022-10C0(1)E
0.0022	10	0.5	C1	TC.0022-10C1(1)E
0.0033	10	0.5	C0	TC.0033-10C0(1)E
0.0033	10	0.5	C1	TC.0033-10C1(1)E
0.0047	10	0.5	C0	TC.0047-10C0(1)E
0.0047	10	0.5	C1	TC.0047-10C1(1)E
0.15	10	0.5	C0	TC.15-10C0(1)M
0.47	6	0.5	C1	TC.47-10C1(1)M
2.2	6	0.5	C2	TC2.2-10C2(1)M
6.8	6	1.0	C3	TC6.8-10C3(1)M
22	6	2.0	C4	TC22-10C4(1)M
33	6	3.0	C5	TC33-10C5(1)M
100	8	9.0	C6	TC100-10C6(1)M

Note

- Part number definition:
(1) Add A for axial, R for radial



STANDARD RATINGS - POLAR CAPACITORS				
CAPACITANCE (μF)	MAX. DF (%)	MAX. DCL AT + 25 °C (μA)	CASE CODE	PART NUMBER
15 V_{DC} AT + 85 °C				
0.10	10	0.5	C0	TC.10-15C0(1)M
0.33	6	0.5	C1	TC.33-15C1(1)M
1.5	6	0.5	C2	TC1.5-15C2(1)M
15	6	2.0	C4	TC15-15C4(1)M
22	6	3.0	C5	TC22-15C5(1)M
68	8	9.0	C6	TC68-15C6(1)M
20 V_{DC} AT + 85 °C				
0.033	10	0.5	C0	TC.033-20C0(1)E
0.033	6	0.5	C1	TC.033-20C1(1)E
0.047	10	0.5	C0	TC.047-20C0(1)E
0.047	6	0.5	C1	TC.047-20C1(1)E
0.068	10	0.5	C0	TC.068-20C0(1)E
0.068	6	0.5	C1	TC.068-20C1(1)E
0.10	6	0.5	C1	TC.10-20C1(1)M
0.15	6	0.5	C1	TC.15-20C1(1)M
0.22	6	0.5	C1	TC.22-20C1(1)M
1.0	6	0.5	C2	TC1.0-20C2(1)M
3.3	6	1.0	C3	TC3.3-20C3(1)M
4.7	6	1.0	C3	TC4.7-20C3(1)M
10	6	2.0	C4	TC10-20C4(1)M
15	6	3.0	C5	TC15-20C5(1)M
47	8	9.0	C6	TC47-20C6(1)M
25 V_{DC} AT + 85 °C				
0.68	6	0.5	C2	TC.68-25C2(1)M
2.2	6	1.0	C3	TC2.2-25C3(1)M
6.8	6	2.0	C4	TC6.8-25C4(1)M
10	6	3.0	C5	TC10-25C5(1)M
33	6	9.0	C6	TC33-25C6(1)M
35 V_{DC} AT + 85 °C				
0.22	6	0.5	C2	TC.22-35C2(1)M
0.33	6	0.5	C2	TC.33-35C2(1)M
0.47	6	0.5	C2	TC.47-35C2(1)M
0.68	6	1.0	C3	TC.68-35C3(1)M
1.0	6	1.0	C3	TC1.0-35C3(1)M
1.5	6	1.0	C3	TC1.5-35C3(1)M
2.2	6	2.0	C4	TC2.2-35C4(1)M
3.3	6	2.0	C4	TC3.3-35C4(1)M
4.7	6	2.0	C4	TC4.7-35C4(1)M
6.8	6	3.0	C5	TC6.8-35C5(1)M
10	6	9.0	C6	TC10-35C6(1)M
15	6	9.0	C6	TC15-35C6(1)M
22	6	9.0	C6	TC22.35C6(1)M
50 V_{DC} AT + 85 °C				
0.15	6	0.5	C2	TC.15-50C2(1)M
4.7	6	3.0	C5	TC4.7-50C5(1)M
6.8	6	9.0	C6	TC6.8-50C6(1)M

Note

- Part number definition:
 - (1) Add A for axial, R for radial



STANDARD RATINGS - NON-POLAR CAPACITORS				
CAPACITANCE (μF)	MAX. DF (%)	MAX. DCL AT + 25 °C (μA)	CASE CODE	PART NUMBER
2 V_{DC} AT + 85 °C				
4.7	10	0.5	N1	TC4.7-2N1(1)M
15	10	1.0	N2	TC15-2N2(1)M
47	15	2.0	N3	TC47-2N3(1)M
68	15	3.0	N4	TC68-2N4(1)M
3 V_{DC} AT + 85 °C				
3.3	10	0.5	N1	TC3.3-3N1(1)M
10	10	1.0	N2	TC10-3N2(1)M
33	10	2.0	N3	TC33-3N3(1)M
47	10	3.0	N4	TC47-3N4(1)M
4 V_{DC} AT + 85 °C				
2.2	8	0.5	N1	TC2.2-4N1(1)M
6.8	8	1.0	N2	TC6.8-4N2(1)M
22	8	2.0	N3	TC22-4N3(1)M
33	8	3.0	N4	TC33-4N4(1)M
6 V_{DC} AT + 85 °C				
1.5	6	0.5	N1	TC1.5-6N1(1)M
4.7	6	1.0	N2	TC4.7-6N2(1)M
15	6	2.0	N3	TC15-6N3(1)M
22	6	3.0	N4	TC22-6N4(1)M
10 V_{DC} AT + 85 °C				
1.0	6	0.5	N1	TC1.0-10N1(1)M
3.3	6	1.0	N2	TC3.3-10N2(1)M
10	6	2.0	N3	TC10-10N3(1)M
15	6	3.0	N4	TC15-10N4(1)M
15 V_{DC} AT + 85 °C				
0.68	6	0.5	N1	TC.68-15N1(1)M
6.8	6	2.0	N3	TC6.8-15N3(1)M
10	6	3.0	N4	TC10-15N4(1)M
20 V_{DC} AT + 85 °C				
0.47	6	0.5	N1	TC.47-20N1(1)M
1.5	6	1.0	N2	TC1.5-20N2(1)M
2.2	6	1.0	N2	TC2.2-20N2(1)M
4.7	6	2.0	N3	TC4.7-20N3(1)M
6.8	6	3.0	N4	TC6.8-20N4(1)M
25 V_{DC} AT + 85 °C				
0.33	6	0.5	N1	TC.33-25N1(1)M
1.0	6	1.0	N2	TC1.0-25N2(1)M
3.3	6	2.0	N3	TC3.3-25N3(1)M
4.7	6	3.0	N4	TC4.7-25N4(1)M
35 V_{DC} AT + 85 °C				
0.10	6	0.5	N1	TC.10-35N1(1)M
0.15	6	0.5	N1	TC.15-35N1(1)M
0.22	6	0.5	N1	TC.22-35N1(1)M
0.33	6	1.0	N2	TC.33-35N2(1)M
0.47	6	1.0	N2	TC.47-35N2(1)M
0.68	6	1.0	N2	TC.68-35N2(1)M
1.0	6	2.0	N3	TC1.0-35N3(1)M
50 V_{DC} AT + 85 °C				
2.2	6	3.0	N4	TC2.2-50N4(1)M

Note

- Part number definition:
 - Add A for axial, R for radial



MARKING

TC Capacitors case sizes C3 - C6 and N2 - N4 are print marked:

- Capacitance is in picofarads
- 1st and 2nd digits are significant figures
- 3rd digit indicates the number of zeros.

All other case sizes have color dot marking:

Capacitance	Color	Digit
-------------	-------	-------

In picofarads, indicated by 3 dots. 1st and 2nd dot give the significant digits. 3rd dot indicates the number of zeros. Color dot location is shown on the dimensional sketches. Black dot is omitted on black sleeve.	Black	0
	Brown	1
	Red	2
	Orange	3
	Yellow	4
	Green	5
	Blue	6
	Violet	7
	Grey	8
	White	9

Capacitance Tolerance	Color	Tolerance
Is indicated by a dot on the side of the case. Black dot is omitted.	Gold	± 5 %
	Silver	± 10 %
	None	± 20 %
	None	+ 40 %/- 20 %

The positive lead is indicated by a color dot of red epoxy on the unit.

e.g. **Yellow-Violet-Green** = 4 700 000 pF
= 4.7 μF

PERFORMANCE AND RELIABILITY

The capacitors are tested in accordance with MIL-PRF-49137, with specific requirements as follows:

Temperature Stability: When tested per MIL-PRF-49137/6, capacitance shall be within $\pm 15\%$ at $-55\text{ }^\circ\text{C}$ and $85\text{ }^\circ\text{C}$, and $\pm 10\%$ at $25\text{ }^\circ\text{C}$ after exposure to temperature extremes. DF shall be within 200 % of initial limit at $-55\text{ }^\circ\text{C}$, 150 % of initial limit at $85\text{ }^\circ\text{C}$, and meet the initial at $25\text{ }^\circ\text{C}$. DCL shall be within 10 x initial limit at $85\text{ }^\circ\text{C}$, and meet the initial limit at $25\text{ }^\circ\text{C}$.

Moisture Resistance: (per method 106 of MIL-STD-202) After 10 cycles of 24 h at $25\text{ }^\circ\text{C}$ to $65\text{ }^\circ\text{C}$ and 80 % to 98 % RH; capacitance shall be within $\pm 15\%$ of initial value, DF within 1.5 x initial limit and leakage within 3 x initial limit.

Life: (per method 108 of MIL-STD-202) after 1000 h at $85\text{ }^\circ\text{C}$ and rated voltage; capacitance shall be within $\pm 10\%$ of initial limit, DF within initial limits, and leakage within 200 % of initial limit.

Surge Voltage: (per MIL-PRF-49317) After 1000 cycles at $85\text{ }^\circ\text{C}$ and $1.3 \times V_{DC}$; capacitance shall be within $\pm 10\%$ of initial limit, DF and leakage within initial limits.

Resistance to Soldering Heat: (per method 210 of MIL-STD-202, condition B) After immersion in $260\text{ }^\circ\text{C}$ molten solder to within a 1/4" of the body of the unit, there shall be no evidence of mechanical or electrical degradation.

Solderability: (per method 208 of MIL-STD-202) After dipping leads in $235\text{ }^\circ\text{C}$ molten solder to within 0.125" of the body of the unit, the solder shall cover 95 % of the lead surface.

Terminal Strength: (per method 211 of MIL-STD-202) After the following test there shall be no loosening of the terminals or permanent damage to the terminals. Test condition A: (pull test) 0.010" leads withstand 1 pound, 0.016" leads 2 pounds and 0.007" leads 1/2 pound. Test condition C: (bend test) All leads shall withstand 3° to 90° bends with a 1/2 pound applied force.

IMPEDANCE VS. FREQUENCY

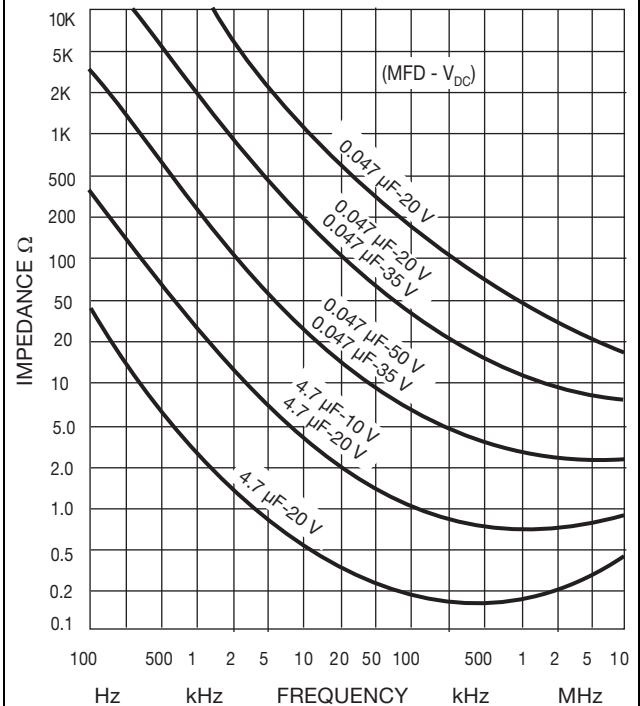

CAPACITANCE VS. TEMPERATURE

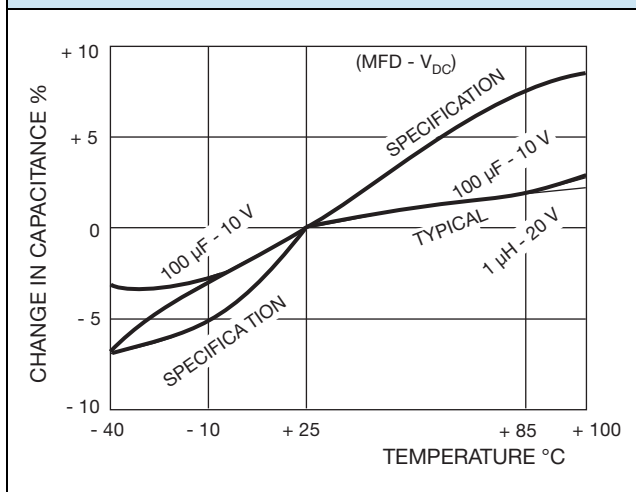

LEAKAGE CURRENT VS. TEMPERATURE

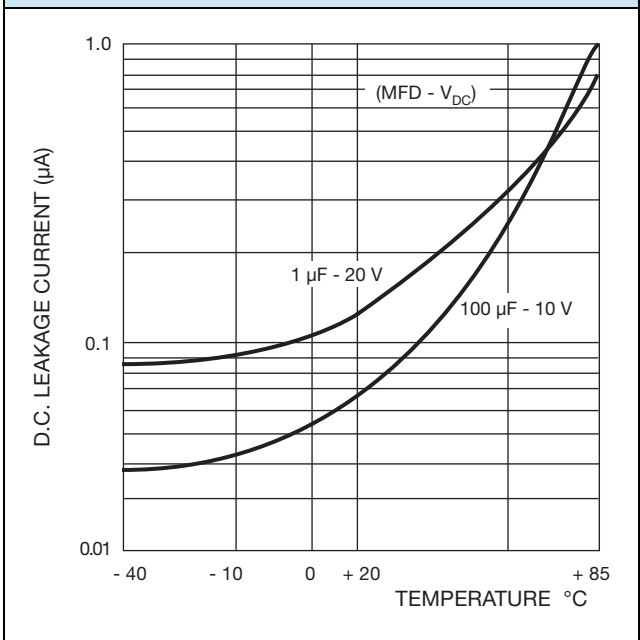



Disclaimer

ALL PRODUCT, PRODUCT SPECIFICATIONS AND DATA ARE SUBJECT TO CHANGE WITHOUT NOTICE TO IMPROVE RELIABILITY, FUNCTION OR DESIGN OR OTHERWISE.

Vishay Intertechnology, Inc., its affiliates, agents, and employees, and all persons acting on its or their behalf (collectively, "Vishay"), disclaim any and all liability for any errors, inaccuracies or incompleteness contained in any datasheet or in any other disclosure relating to any product.

Vishay makes no warranty, representation or guarantee regarding the suitability of the products for any particular purpose or the continuing production of any product. To the maximum extent permitted by applicable law, Vishay disclaims (i) any and all liability arising out of the application or use of any product, (ii) any and all liability, including without limitation special, consequential or incidental damages, and (iii) any and all implied warranties, including warranties of fitness for particular purpose, non-infringement and merchantability.

Statements regarding the suitability of products for certain types of applications are based on Vishay's knowledge of typical requirements that are often placed on Vishay products in generic applications. Such statements are not binding statements about the suitability of products for a particular application. It is the customer's responsibility to validate that a particular product with the properties described in the product specification is suitable for use in a particular application. Parameters provided in datasheets and/or specifications may vary in different applications and performance may vary over time. All operating parameters, including typical parameters, must be validated for each customer application by the customer's technical experts. Product specifications do not expand or otherwise modify Vishay's terms and conditions of purchase, including but not limited to the warranty expressed therein.

Except as expressly indicated in writing, Vishay products are not designed for use in medical, life-saving, or life-sustaining applications or for any other application in which the failure of the Vishay product could result in personal injury or death. Customers using or selling Vishay products not expressly indicated for use in such applications do so at their own risk. Please contact authorized Vishay personnel to obtain written terms and conditions regarding products designed for such applications.

No license, express or implied, by estoppel or otherwise, to any intellectual property rights is granted by this document or by any conduct of Vishay. Product names and markings noted herein may be trademarks of their respective owners.

Material Category Policy

Vishay Intertechnology, Inc. hereby certifies that all its products that are identified as RoHS-Compliant fulfill the definitions and restrictions defined under Directive 2011/65/EU of The European Parliament and of the Council of June 8, 2011 on the restriction of the use of certain hazardous substances in electrical and electronic equipment (EEE) - recast, unless otherwise specified as non-compliant.

Please note that some Vishay documentation may still make reference to RoHS Directive 2002/95/EC. We confirm that all the products identified as being compliant to Directive 2002/95/EC conform to Directive 2011/65/EU.

Vishay Intertechnology, Inc. hereby certifies that all its products that are identified as Halogen-Free follow Halogen-Free requirements as per JEDEC JS709A standards. Please note that some Vishay documentation may still make reference to the IEC 61249-2-21 definition. We confirm that all the products identified as being compliant to IEC 61249-2-21 conform to JEDEC JS709A standards.