

# VHF/UHF Transistors

## Features

- We declare that the material of product compliance with RoHS requirements.

## ORDERING INFORMATION

Device	Marking	Shipping
LMBTH10WT1G	3E	3000/Tape&Reel
LMBTH10WT3G	3E	10000/Tape&Reel

## MAXIMUM RATINGS

Rating	Symbol	Value	Unit
Collector–Emitter Voltage	$V_{CEO}$	25	Vdc
Collector–Base Voltage	$V_{CBO}$	30	Vdc
Emitter–Base Voltage	$V_{EBO}$	3.0	Vdc
Collector Current	$I_C$	50	mA

## THERMAL CHARACTERISTICS

Characteristic	Symbol	Max	Unit
Total Device Dissipation FR-5 Board (1) $T_A = 25^\circ\text{C}$ Derate above $25^\circ\text{C}$	$P_D$	150	mW
Thermal Resistance, Junction to Ambient	$R_{\theta JA}$	833	$^\circ\text{C/W}$
Total Device Dissipation Alumina Substrate, (2) $T_A = 25^\circ\text{C}$ Derate above $25^\circ\text{C}$	$P_D$	200	mW
Thermal Resistance, Junction to Ambient	$R_{\theta JA}$	625	$^\circ\text{C/W}$
Junction and Storage Temperature	$T_J, T_{stg}$	-55to+150	$^\circ\text{C}$

1. FR-5 = 1.0 x 0.75 x 0.062 in.

2. Alumina = 0.4 x 0.3 x 0.024 in. 99.5% alumina.

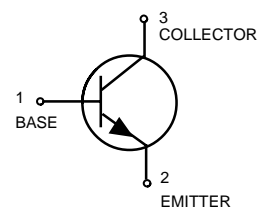
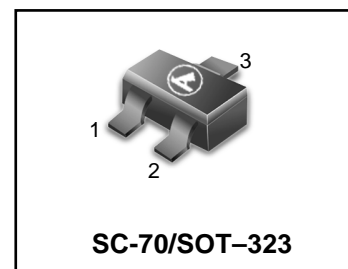
## ELECTRICAL CHARACTERISTICS ( $T_A = 25^\circ\text{C}$ unless otherwise noted.)

Characteristic	Symbol	Min	Typ	Max	Unit
----------------	--------	-----	-----	-----	------

## OFF CHARACTERISTICS

Collector–Emitter Breakdown Voltage ( $I_C = 1.0\text{ mAdc}, I_E = 0$ )	$V_{(BR)CEO}$	25	—	—	Vdc
Collector–Base Breakdown Voltage ( $I_C = 100\ \mu\text{Adc}, I_E = 0$ )	$V_{(BR)CBO}$	30	—	—	Vdc
Emitter–Base Breakdown Voltage ( $I_E = 10\ \mu\text{Adc}, I_C = 0$ )	$V_{(BR)EBO}$	3.0	—	—	Vdc
Collector Cutoff Current ( $V_{CB} = 25\text{Vdc}, I_E = 0$ )	$I_{CBO}$	—	—	100	nAdc
Emitter Cutoff Current ( $V_{EB} = 2.0\text{Vdc}, I_C = 0$ )	$I_{EBO}$	—	—	100	nAdc

## LMBTH10WT1G



**LMBTH10WT1G**
**ELECTRICAL CHARACTERISTICS** ( $T_A = 25^\circ\text{C}$  unless otherwise noted) (Continued)

Characteristic	Symbol	Min	Typ	Max	Unit
----------------	--------	-----	-----	-----	------

**ON CHARACTERISTICS**

DC Current Gain ( $I_C = 4.0\text{ mA}$ , $V_{CE} = 10\text{ Vdc}$ )	$h_{FE}$	60	—	270	—
Collector–Emitter Saturation Voltage ( $I_C = 4.0\text{ mA}$ , $I_B = 0.4\text{ mA}$ )	$V_{CE(sat)}$	—	—	0.5	Vdc
Base–Emitter On Voltage ( $I_C = 4.0\text{ mA}$ , $V_{CE} = 10\text{ Vdc}$ )	$V_{BE}$	—	—	0.95	Vdc

**SMALL–SIGNAL CHARACTERISTICS**

Current Gain–Bandwidth Product ( $V_{CE} = 10\text{ Vdc}$ , $I_C = 4.0\text{ mA}$ , $f = 100\text{ MHz}$ )	$f_T$	650	—	—	MHz
Collector –Base Capacitance ( $V_{CB} = 10\text{ Vdc}$ , $I_E = 0$ , $f = 1.0\text{ MHz}$ )	$C_{cb}$	—	0.7	—	pF
Collector –Base Feedback Capacitance ( $V_{CB} = 10\text{ Vdc}$ , $I_E = 0$ , $f = 1.0\text{ MHz}$ )	$C_{fb}$	—	0.65	—	pF
Collector Base Time Constant ( $I_C = 4.0\text{ mA}$ , $V_{CB} = 10\text{ Vdc}$ , $f = 31.8\text{ MHz}$ )	$r_b' C_C$	—	—	9.0	ps

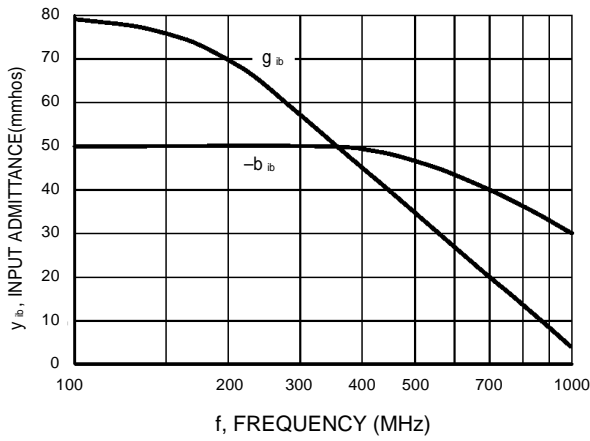
**LMBTH10WT1G**

**TYPICAL CHARACTERISTICS**

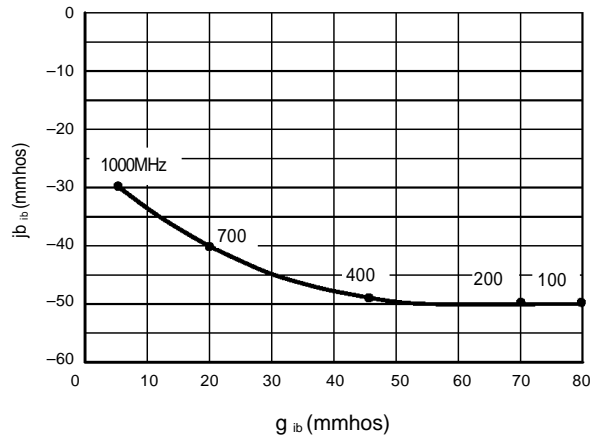
**COMMON-BASE y PARAMETERS versus FREQUENCY**

( $V_{CB} = 10 \text{ Vdc}$ ,  $I_C = 4.0 \text{ mAdc}$ ,  $T_A = 25^\circ\text{C}$ )

**$y_{ib}$ , INPUT ADMITTANCE**

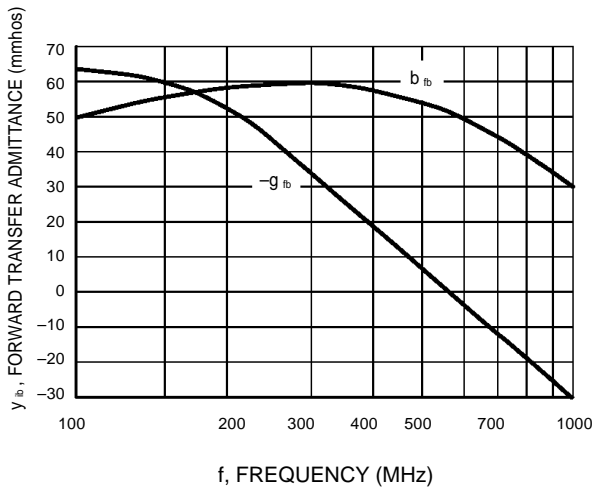


**Figure 1. Rectangular Form**

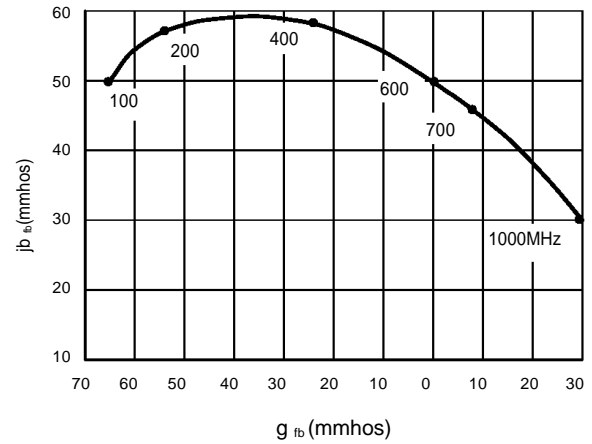


**Figure 2. Polar Form**

**$y_{fb}$ , FORWARD TRANSFER ADMITTANCE**



**Figure 3. Rectangular Form**



**Figure 4. Polar Form**

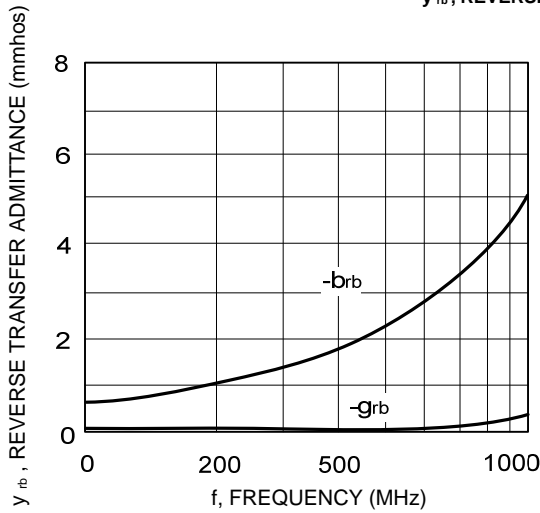
**LMBTH10WT1G**

**TYPICAL CHARACTERISTICS**

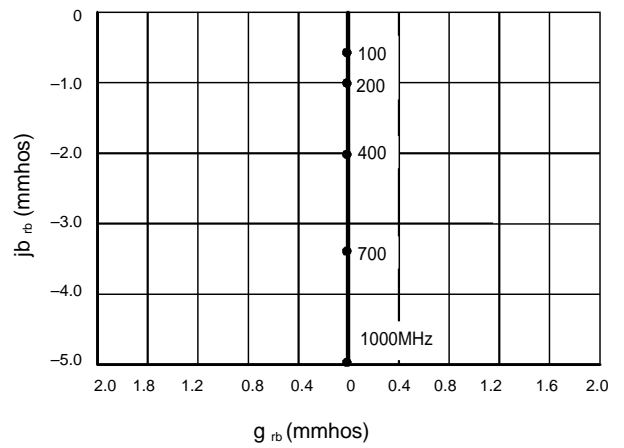
**COMMON-BASE  $y$  PARAMETERS versus FREQUENCY**

( $V_{CB} = 10$  Vdc,  $I_C = 4.0$  mAdc,  $T_A = 25^\circ\text{C}$ )

**$y_{rb}$ , REVERSE TRANSFER ADMITTANCE**

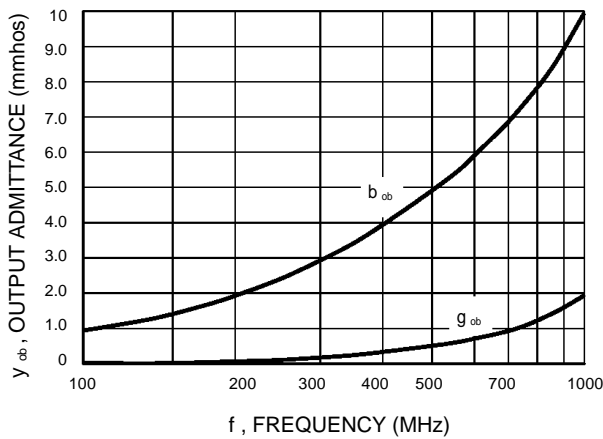


**Figure 5. Rectangular Form**

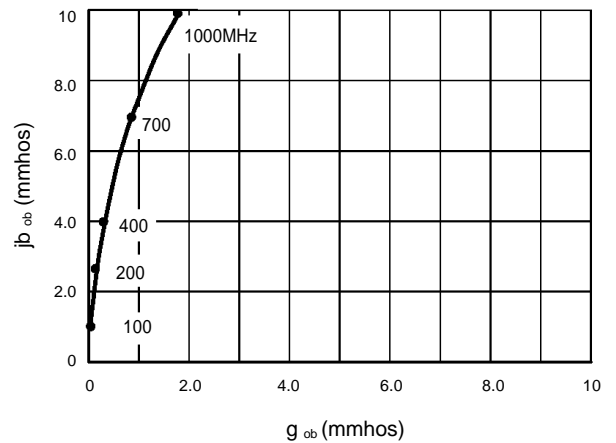


**Figure 6. Polar Form**

**$y_{ob}$ , OUTPUT ADMITTANCE**



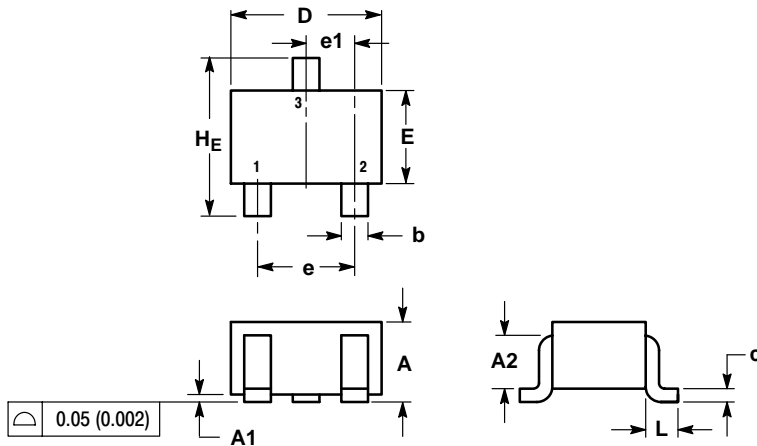
**Figure 7. Rectangular Form**



**Figure 8. Polar Form**

LMBTH10WT1G

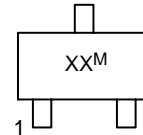
SC-70 / SOT-323



NOTES:  
 1. DIMENSIONING AND TOLERANCING PER ANSI Y14.5M, 1982.  
 2. CONTROLLING DIMENSION: INCH.

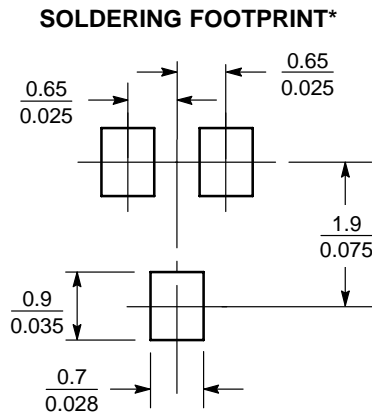
DIM	MILLIMETERS			INCHES		
	MIN	NOM	MAX	MIN	NOM	MAX
A	0.80	0.90	1.00	0.032	0.035	0.040
A1	0.00	0.05	0.10	0.000	0.002	0.004
A2	0.7 REF			0.028 REF		
b	0.30	0.35	0.40	0.012	0.014	0.016
c	0.10	0.18	0.25	0.004	0.007	0.010
D	1.80	2.10	2.20	0.071	0.083	0.087
E	1.15	1.24	1.35	0.045	0.049	0.053
e	1.20	1.30	1.40	0.047	0.051	0.055
e1	0.65 BSC			0.026 BSC		
L	0.425 REF			0.017 REF		
H	2.00	2.10	2.40	0.079	0.083	0.095

GENERIC MARKING DIAGRAM



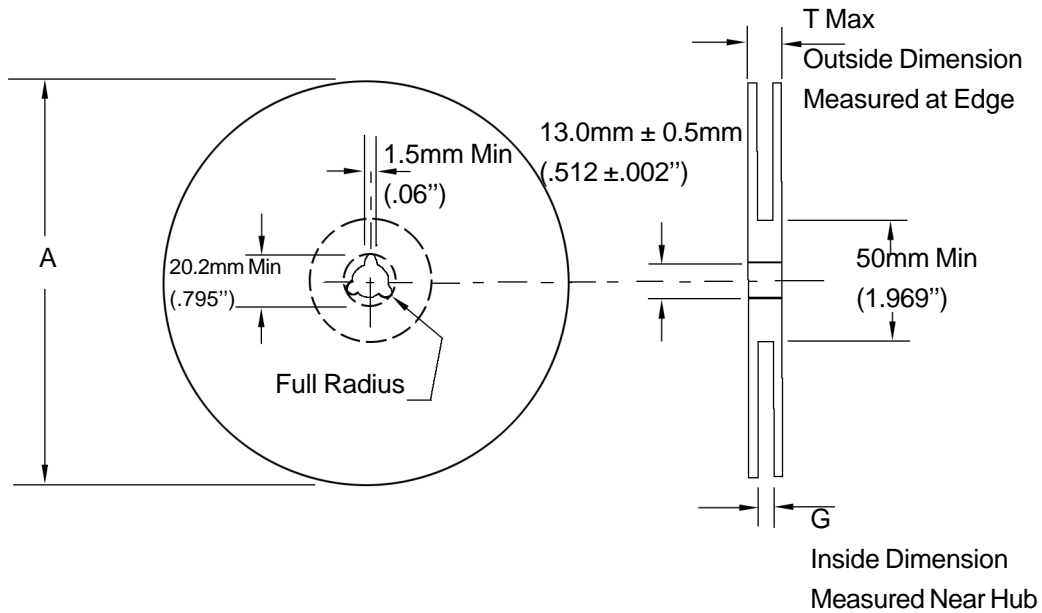
- XX = Specific Device Code
- M = Date Code
- = Pb-Free Package

\*This information is generic. Please refer to device data sheet for actual part marking. Pb-Free indicator, "G" or microdot "▪", may or may not be present.



SCALE 10:1 (mm/inches)

## EMBOSSED TAPE AND REEL DATA FOR DISCRETES



Size	A Max	G	T Max
8 mm	330mm (12.992")	8.4mm+1.5mm, -0.0 (.33"+.059", -0.00)	14.4mm (.56")

### Reel Dimensions

Metric Dimensions Govern — English are in parentheses for reference only

#### Storage Conditions

Temperature: 5 to 40 Deg.C (20 to 30 Deg. C is preferred)

Humidity: 30 to 80 RH (40 to 60 is preferred )

Recommended Period: One year after manufacturing

(This recommended period is for the soldering condition only. The characteristics and reliabilities of the products are not restricted to this limitation)

## Shipment Specification

