

\*RoHS COMPLIANT



**BOURNS®**

**Features**

- Surface Mount / Single Turn / Cermet Industrial / Sealed
- Compatible with surface mount manufacturing processes
- Compatible with popular vacuum pick-and-place equipment
- J-hook, gull-wing and pinned configurations

- Side adjust available
- Meets EIA/EIAJ/IPC/VECI SMD standard trimmer designs
- RoHS compliant\* - see [processing information](#) on lead free surface mount trimmers
- For trimmer applications/processing guidelines, [click here](#)

**3314 - 4 mm Square Trimpot® Trimming Potentiometer**

**Electrical Characteristics**

Standard Resistance Range ..... 10 ohms to 2 megohms (see standard resistance table)  
 Resistance Tolerance ..... ±20 % std. (tighter tolerance available)  
 End Resistance ..... 1 % or 2 ohms max. (whichever is greater)  
 Contact Resistance Variation ..... 3 % or 3 ohms  
 Resolution ..... Infinite  
 Insulation Resistance ..... 500 vdc. 100 megohms min.  
 Dielectric Strength  
 Sea Level..... 500 vac (1 minute)  
 Adjustment Angle ..... 210 ° nom.

**Environmental Characteristics**

Power Rating (300 volts max. for Style G, J & H; 50 volts max. for Style R)  
 70 °C ..... 0.25 watt  
 125 °C ..... 0 watt  
 Temperature Range ... -55 °C to +125 °C  
 Temperature Coefficient ... ±100 ppm/°C  
 Humidity ..... 90-98 % RH, 10 cycles, 240 hours  
 TRS ±2 %; IR 10 megohms  
 Vibration ..... 20 G TRS ±1 %; VRS ±1 %  
 Shock ..... 100 G TRS ±1 %; VRS ±1 %  
 Load Life  
 ...(@ 70 °C Rated Power 1000 Hours)  
 TRS ±3 %  
 Rotational Life ..... 100 cycles  
 TRS ±3 %  
 Thermal Shock ..... 5 cycles  
 TRS ±2 %; VRS ±1 %

**Physical Characteristics**

Mechanical Angle ..... 240 ° nom.  
 Torque ..... 180 g-cm max.  
 Stop Strength ..... 300 g-cm min.  
 Pushover Strength (S & Z Style) ..... 1.6 kilograms (3.5 lbs.) min.  
 Weight ..... Approximately 0.01 oz.  
 Marking ..... Manufacturer's code, resistance code and date code  
 Wiper ..... 50 % (Actual TR) ±10 %  
 Flammability ..... U.L. 94V-0  
 Standard Packaging  
 J, G and R ..... 500 pcs./7 " reel  
 S and Z ..... 200 pcs./7 " reel  
 H ..... 100 pcs./tube  
 Adjustment Tool ..... H-90

**Product Dimensions**

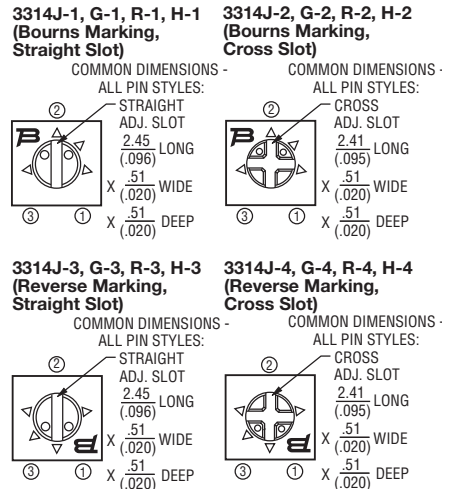
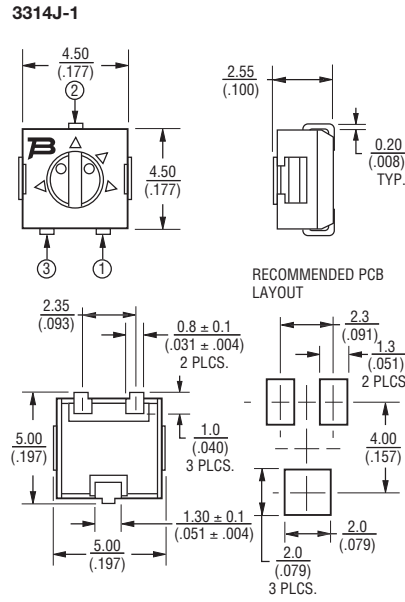

**How To Order**

**3314 J - 1 - 502 E**

Model \_\_\_\_\_  
 Style \_\_\_\_\_  
 Standard or Modified Product Indicator (Styles J, G, R, H & S)  
 -1 = Single Slot  
 -2 = Cross Slot  
 -3 = Single Slot w/Reverse Marking  
 -4 = Cross Slot w/Reverse Marking  
 Product Indicator (Style Z only)  
 -GA4 = Single Slot  
 -1 = Cross Slot  
 -3 = Single Slot w/Reverse Marking  
 -4 = Cross Slot w/Reverse Marking  
 Resistance Code \_\_\_\_\_  
 Embossed Tape Designator\*\*  
 E = Styles J, G and R: 500 pcs./7 " reel  
 Styles S and Z: 200 pcs./7 " reel  
 G = Styles J and G: 3000 pcs./13 " reel  
 Style R: 2500 pcs./13 " reel  
 Styles S and Z: 1000 pcs./13 " reel  
 \*\*Style H is available in tube packaging only.

**Standard Resistance Table**

Resistance (Ohms)	Resistance Code
10	100
20	200
50	500
<b>100</b>	<b>101</b>
<b>200</b>	<b>201</b>
<b>500</b>	<b>501</b>
<b>1,000</b>	<b>102</b>
<b>2,000</b>	<b>202</b>
<b>5,000</b>	<b>502</b>
<b>10,000</b>	<b>103</b>
<b>20,000</b>	<b>203</b>
<b>50,000</b>	<b>503</b>
<b>100,000</b>	<b>104</b>
200,000	204
250,000	254
500,000	504
1,000,000	105
2,000,000	205

Popular distribution values listed in boldface. Special resistances available.

\*RoHS Directive 2002/95/EC Jan. 27, 2003 including annex and RoHS Recast 2011/65/EU June 8, 2011. Specifications are subject to change without notice. The device characteristics and parameters in this data sheet can and do vary in different applications and actual device performance may vary over time. Users should verify actual device performance in their specific applications.

# 3314 - 4 mm Square Trimpot® Trimming Potentiometer

# BOURNS®

## Product Dimensions

3314R-1

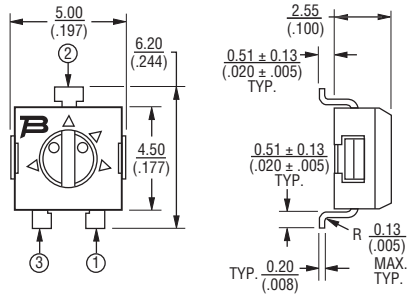

### RECOMMENDED PCB LAYOUT

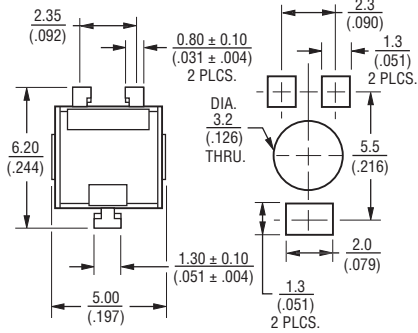

3314H-1

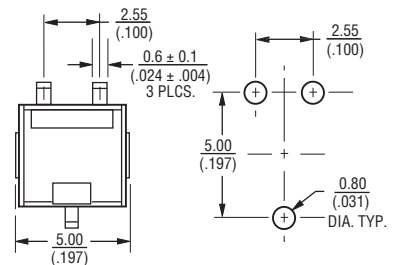
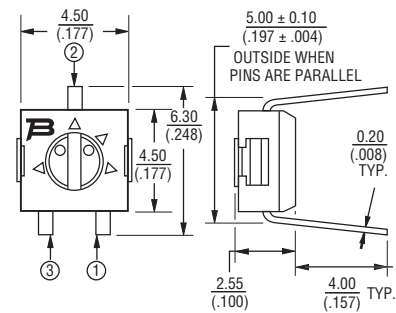

## Packaging Specifications - J, G and R Styles

(J, G Styles)

TAPE

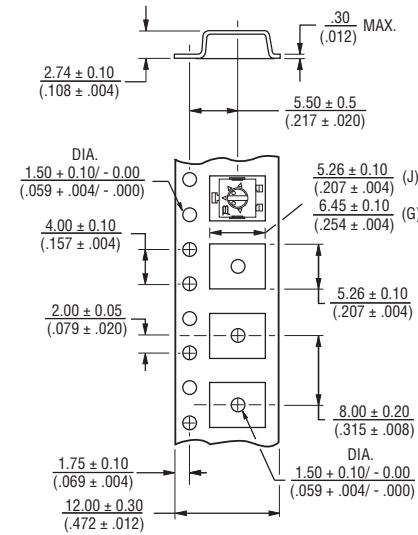

(R Style)

TAPE

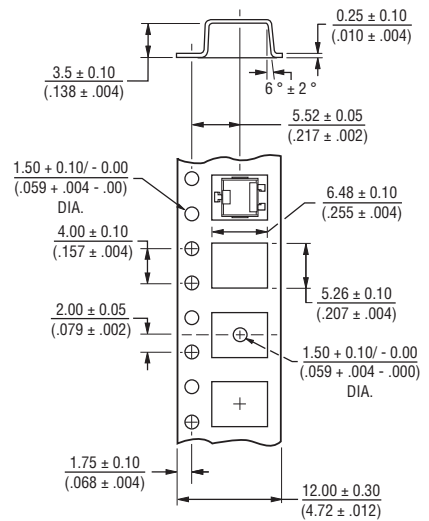

REEL

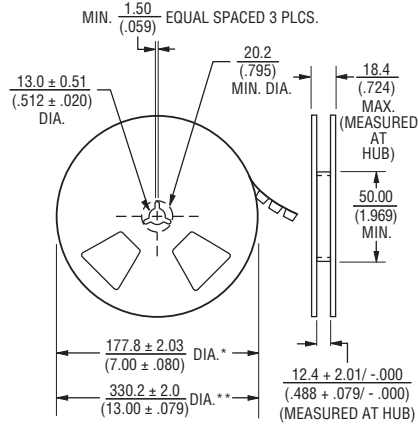

REEL

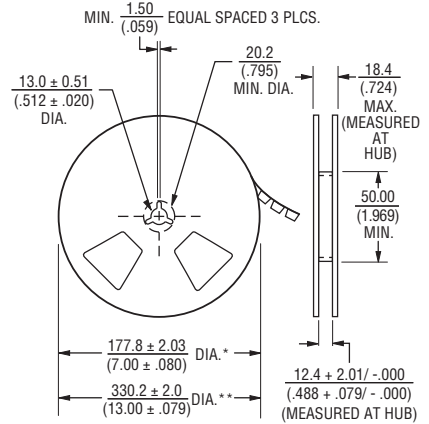

\* Embossed Tape Designator 'E'  
\*\* Embossed Tape Designator 'G'  
(See How To Order chart for further information.)

Meets EIA specification 481.

\* Embossed Tape Designator 'E'  
\*\* Embossed Tape Designator 'G'  
(See How To Order chart for further information.)

Meets EIA specification 481.

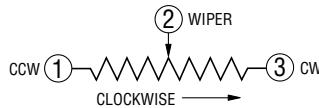

DIMENSIONS:  $\frac{\text{MM}}{\text{(INCHES)}}$   
TOLERANCES:  $\pm \frac{0.25}{(.010)}$  EXCEPT WHERE NOTED

Specifications are subject to change without notice. The device characteristics and parameters in this data sheet can and do vary in different applications and actual device performance may vary over time. Users should verify actual device performance in their specific applications.

# 3314 - 4 mm Square Trimpot® Trimming Potentiometer

# BOURNS®

## Product Dimensions

### 3314S-1 (Bourns Marking, Straight Slot)

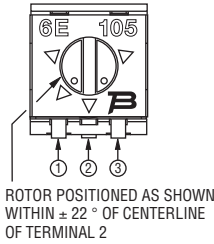

### 3314S-2 (Bourns Marking, Cross Slot)

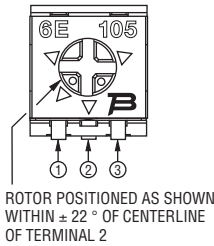

### 3314S-3 (Reverse Marking, Straight Slot)

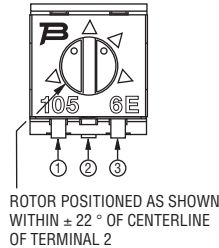

### 3314S-4 (Reverse Marking, Cross Slot)

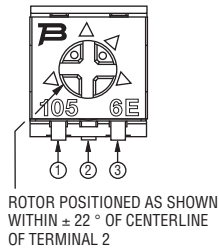

### 3314S Common Dimensions

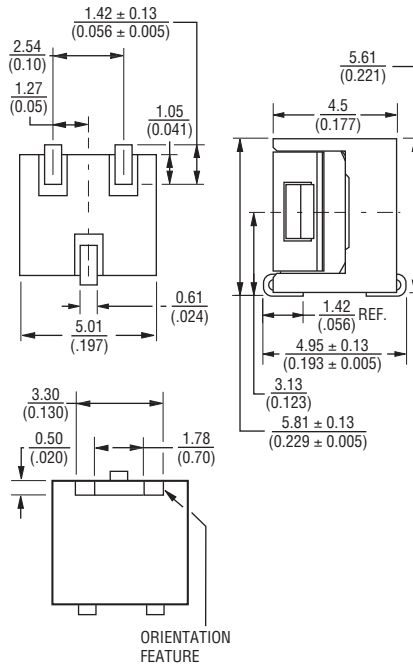

### RECOMMENDED PCB LAYOUT

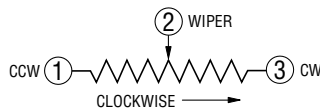
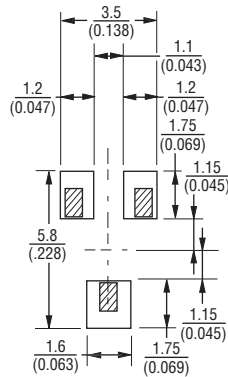

## Packaging Specifications

### (S Style)

#### TAPE

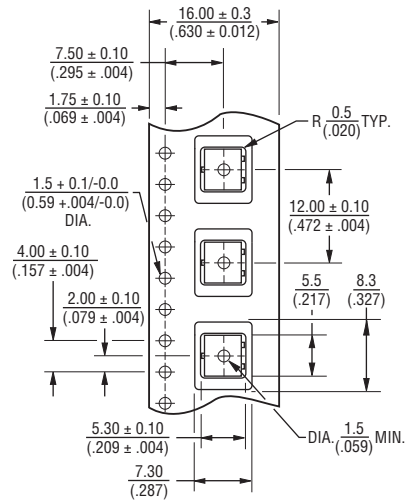
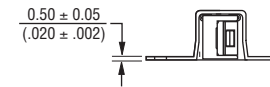

#### REEL

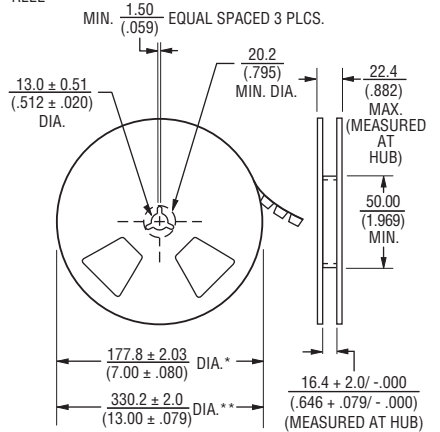

\* Embossed Tape Designator "E"  
\*\* Embossed Tape Designator "G"  
(See How To Order chart for further information.)

Meets EIA specification 481.

DIMENSIONS:  $\frac{\text{MM}}{\text{(INCHES)}}$

TOLERANCES:  $\pm \frac{0.30}{(0.012)}$  EXCEPT WHERE NOTED

Specifications are subject to change without notice. The device characteristics and parameters in this data sheet can and do vary in different applications and actual device performance may vary over time. Users should verify actual device performance in their specific applications.

# 3314 - 4 mm Square Trimpot® Trimming Potentiometer

# BOURNS®

## Product Dimensions

**3314Z-1-(RC) E**  
(Cross Slot)

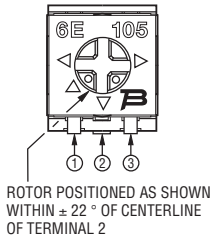

**3314Z-GA4-(RC) E**  
(Straight Slot)

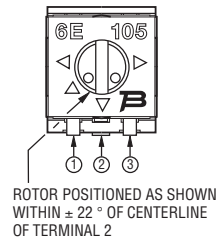

**3314Z-3**  
(Reverse Marking, Straight Slot)

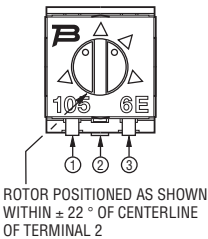

**3314Z-4-(RC) E**  
(Reverse Marking, Cross Slot)

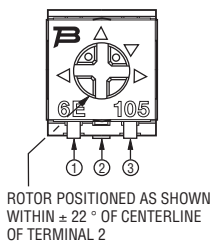

**3314Z**  
Common Dimensions

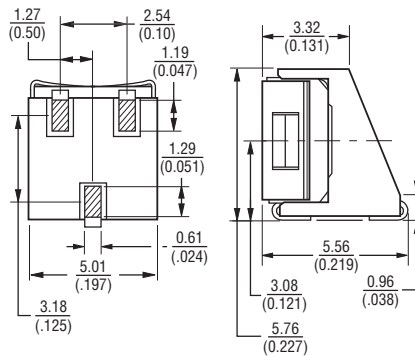

RECOMMENDED PCB LAYOUT

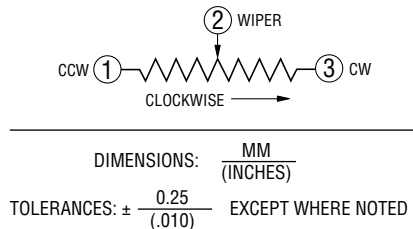
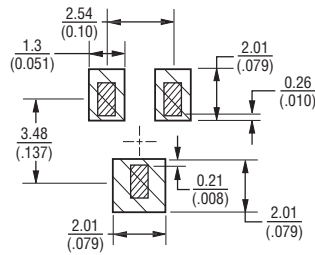

## Packaging Specifications

(Z Style)

TAPE

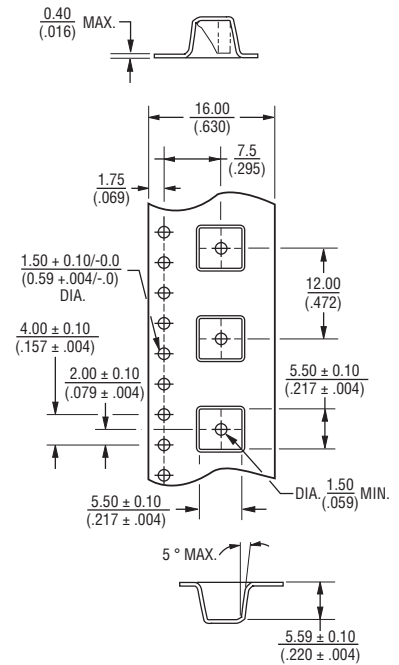

REEL

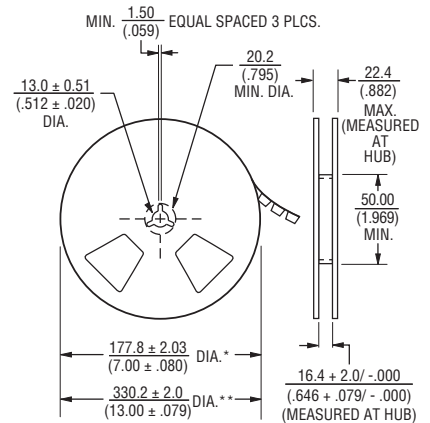

\* Embossed Tape Designator "E"  
\*\* Embossed Tape Designator "G"  
(See How To Order chart for further information.)

Meets EIA specification 481.

# Mouser Electronics

Authorized Distributor

Click to View Pricing, Inventory, Delivery & Lifecycle Information:

## Bourns:

[3314H-1-104](#) [3314H-1-101](#) [3314H-1-105](#) [3314H-1-102](#) [3314H-1-103](#) [3314J-1-754E](#) [3314H-1-504](#) [3314H-1-501](#)  
[3314H-1-500](#) [3314H-1-503](#) [3314H-1-502](#) [3314G-1-254E](#) [3314Z-GA4-203E](#) [3314Z-GA4-205E](#) [3314Z-GA4-201E](#)  
[3314Z-GA4-103E](#) [3314Z-GA4-101E](#) [3314G-1-504E](#) [3314G-2-503E](#) [3314J-2-503G](#) [3314R-2-503G](#) [3314J-2-501E](#)  
[3314J-2-503E](#) [3314G-2-501E](#) [3314R-2-503E](#) [3314J-2-253E](#) [3314J-2-502E](#) [3314J-2-500E](#) [3314G-2-504E](#) [3314G-2-](#)  
[502E](#) [3314J-2-504G](#) [3314G-2-500E](#) [3314J-2-504E](#) [3314J-1-223E](#) [3314G-1-504G](#) [3314J-1-504E](#) [3314R-1-502E](#)  
[3314Z-1-502G](#) [3314J-1-502E](#) [3314J-1-502G](#) [3314Z-1-502E](#) [3314J-1-500E](#) [3314J-1-504G](#) [3314Z-1-504E](#) [3314G-1-](#)  
[500E](#) [3314S-1-502E](#) [3314R-1-500E](#) [3314R-1-504E](#) [3314G-1-502E](#) [3314Z-1-500E](#) [3314J-1-503E](#) [3314Z-1-503G](#)  
[3314J-1-503G](#) [3314Z-1-503E](#) [3314R-1-503E](#) [3314G-1-205E](#) [3314J-1-201G](#) [3314Z-1-201E](#) [3314J-1-201E](#) [3314S-1-](#)  
[201E](#) [3314R-1-201E](#) [3314Z-1-205E](#) [3314G-1-201E](#) [3314G-1-201G](#) [3314J-1-205E](#) [3314J-1-104E](#) [3314G-1-100E](#)  
[3314S-1-104E](#) [3314J-1-100E](#) [3314R-1-104E](#) [3314J-1-104G](#) [3314Z-1-104E](#) [3314G-1-104E](#) [3314G-1-104G](#) [3314Z-1-](#)  
[100E](#) [3314H-1-202](#) [3314H-1-204](#) [3314H-1-203](#) [3314H-1-201](#) [3314Z-10-201E](#) [3314Z-10-500E](#) [3314G-1-203G](#)  
[3314J-3-102E](#) [3314J-3-201E](#) [3314J-3-202E](#) [3314J-3-502E](#) [3314R-1-223E](#) [3314R-2-502E](#) [3314S-1-100E](#) [3314S-1-](#)  
[105E](#) [3314S-1-200E](#) [3314S-1-204E](#) [3314S-1-205E](#) [3314S-1-254E](#) [3314S-1-500E](#) [3314S-1-504E](#) [3314S-2-100E](#)  
[3314S-2-101E](#) [3314S-2-102E](#) [3314S-2-103E](#)