

NESG3033M14

NPN SiGe RF Transistor for Low Noise, High-Gain Amplification 4-Pin Lead-Less Minimold (M14, 1208 PKG)

R09DS0049EJ0300
Rev.3.00
Sep 14, 2012

FEATURES

- The NESG3033M14 is an ideal choice for low noise, high-gain amplification
NF = 0.6 dB TYP. @ $V_{CE} = 2\text{ V}$, $I_C = 6\text{ mA}$, $f = 2.0\text{ GHz}$
- Maximum stable power gain: MSG = 20.5 dB TYP. @ $V_{CE} = 2\text{ V}$, $I_C = 15\text{ mA}$, $f = 2.0\text{ GHz}$
- SiGe HBT technology (UHS3) adopted: $f_{max} = 110\text{ GHz}$
- This product is improvement of ESD of NESG3032M14.
- 4-pin lead-less minimold (M14, 1208 PKG)

<R>

ORDERING INFORMATION

Part Number	Order Number	Package	Quantity	Supplying Form
NESG3033M14	NESG3033M14-A	4-pin lead-less minimold (M14, 1208 PKG) (Pb-Free)	50 pcs (Non reel)	<ul style="list-style-type: none"> • 8 mm wide embossed taping • Pin 1 (Collector), Pin 4 (NC) face the perforation side of the tape
NESG3033M14-T3	NESG3033M14-T3-A		10 kpcs/reel	

Remark To order evaluation samples, please contact your nearby sales office.
Unit sample quantity is 50 pcs.

ABSOLUTE MAXIMUM RATINGS ($T_A = +25^\circ\text{C}$)

Parameter	Symbol	Ratings	Unit
Collector to Base Voltage	V_{CBO} ^{Note 1}	5.0	V
Collector to Emitter Voltage	V_{CEO}	4.3	V
Base Current	I_B ^{Note 1}	12	mA
Collector Current	I_C	35	mA
Total Power Dissipation	P_{tot} ^{Note 2}	150	mW
Junction Temperature	T_j	150	$^\circ\text{C}$
Storage Temperature	T_{sig}	-65 to +150	$^\circ\text{C}$

Notes 1. V_{CBO} and I_B are limited by the permissible current of the protection element.

2. Mounted on $1.08\text{ cm}^2 \times 1.0\text{ mm}$ (t) glass epoxy PWB

CAUTION

Observe precautions when handling because these devices are sensitive to electrostatic discharge.

The mark <R> shows major revised points.

The revised points can be easily searched by copying an "<R>" in the PDF file and specifying it in the "Find what:" field.

RECOMMENDED OPERATING RANGE (T_A = +25°C)

Parameter	Symbol	MIN.	TYP.	MAX.	Unit
Input Power	P _{in}	-	-	0	dBm
Base Feedback Resister	R _b	-	-	100	kΩ

Remark When the voltage return bias circuit like the figure below is used, a current increase is seen because the ESD protection element is turned on when recommended range of motion in the above table is exceeded. However, there is no influence of reliability, including deterioration.

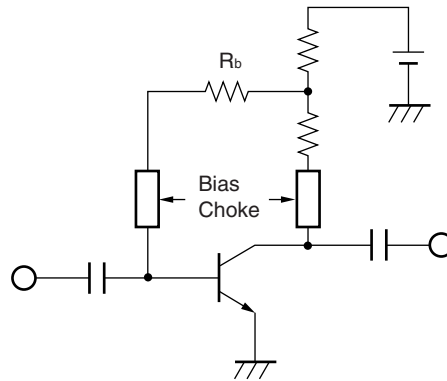

<R> ELECTRICAL CHARACTERISTICS (T_A = +25°C)

Parameter	Symbol	Test Conditions	MIN.	TYP.	MAX.	Unit
DC Characteristics						
Collector Cut-off Current	I _{CBO}	V _{CB} = 5 V, I _E = 0	–	–	100	nA
Emitter Cut-off Current	I _{EBO}	V _{EB} = 1 V, I _C = 0	–	–	100	nA
DC Current Gain	h _{FE} ^{Note 1}	V _{CE} = 2 V, I _C = 6 mA	220	300	380	–
RF Characteristics						
Insertion Power Gain	S _{21e} ²	V _{CE} = 2 V, I _C = 15 mA, f = 2.0 GHz	15.0	17.5	–	dB
Noise Figure	NF	V _{CE} = 2 V, I _C = 6 mA, f = 2.0 GHz, Z _S = Z _{Sopt} , Z _L = Z _{Lopt}	–	0.60	0.85	dB
Associated Gain	G _a	V _{CE} = 2 V, I _C = 6 mA, f = 2.0 GHz, Z _S = Z _{Sopt} , Z _L = Z _{Lopt}	–	17.5	–	dB
Reverse Transfer Capacitance	C _{re} ^{Note 2}	V _{CB} = 2 V, I _E = 0, f = 1 MHz	–	0.15	0.25	pF
Maximum Stable Power Gain	MSG ^{Note 3}	V _{CE} = 2 V, I _C = 15 mA, f = 2.0 GHz	17.5	20.5	–	dB
Gain 1 dB Compression Output Power	P _O (1 dB)	V _{CE} = 3 V, I _{C (set)} = 20 mA, f = 2.0 GHz, Z _S = Z _{Sopt} , Z _L = Z _{Lopt}	–	12.5	–	dBm
3rd Order Intermodulation Distortion Output Intercept Point	OIP ₃	V _{CE} = 3 V, I _{C (set)} = 20 mA, f = 2.0 GHz, Z _S = Z _{Sopt} , Z _L = Z _{Lopt}	–	24.0	–	dBm

- Notes 1.** Pulse measurement: PW ≤ 350 μs, Duty Cycle ≤ 2%
2. Collector to base capacitance when the emitter grounded

3. $MSG = \left| \frac{S_{21}}{S_{12}} \right|$

<R> h_{FE} CLASSIFICATION

Rank	FB/YFB
Marking	zL
h _{FE} Value	220 to 380

TYPICAL CHARACTERISTICS (T_A = +25°C, unless otherwise specified)

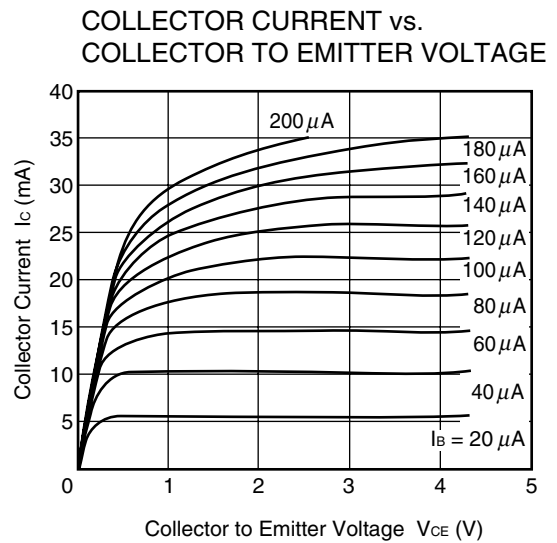
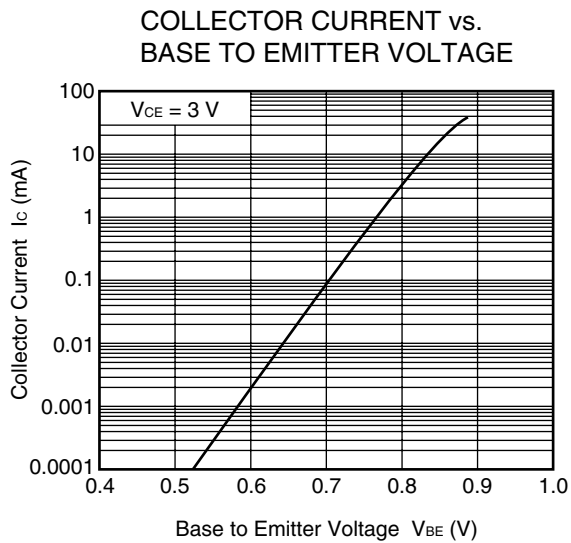
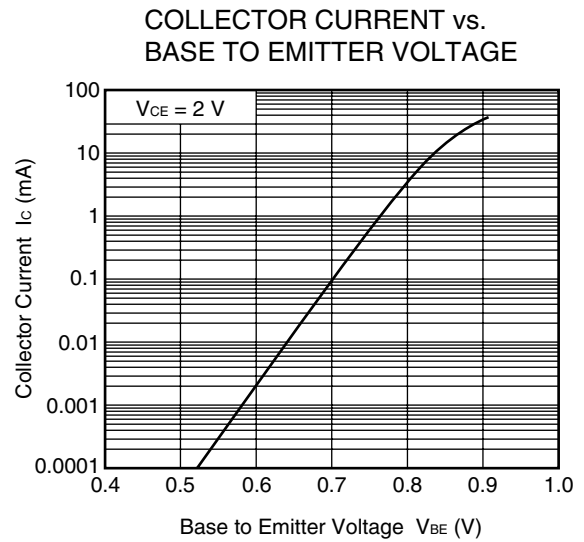
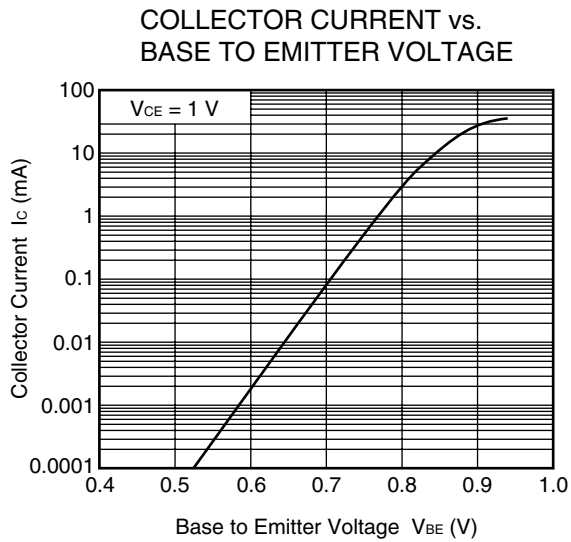
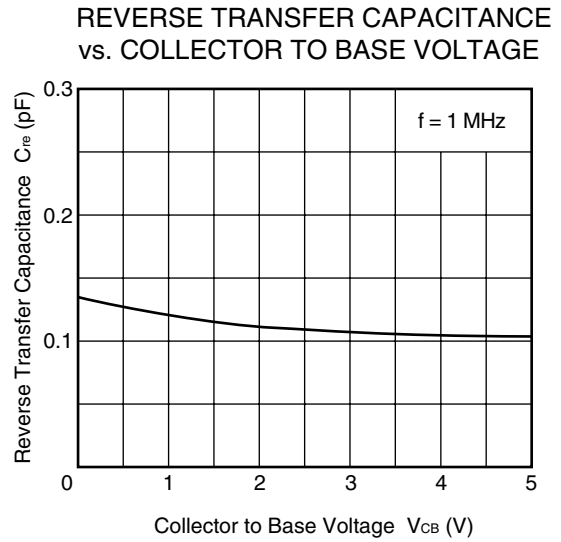
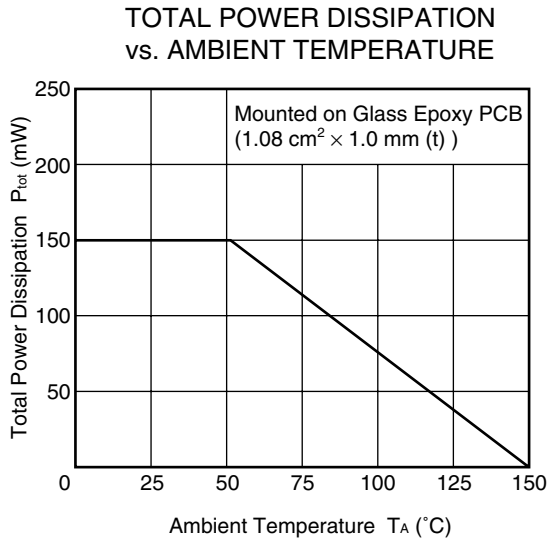

Remark The graphs indicate nominal characteristics.

DC CURRENT GAIN vs.
COLLECTOR CURRENT

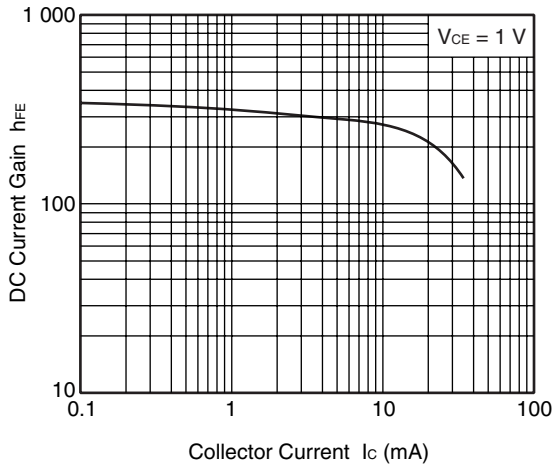

DC CURRENT GAIN vs.
COLLECTOR CURRENT

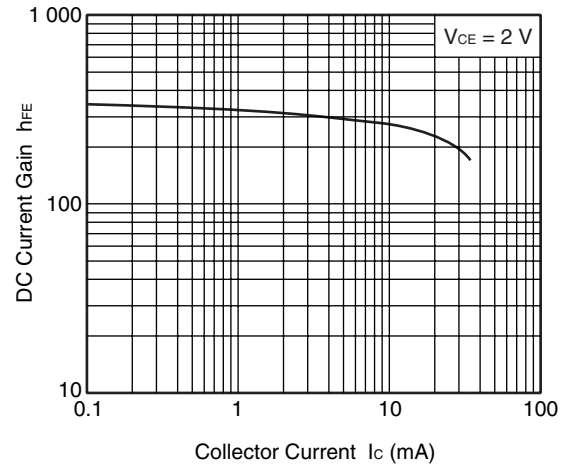

DC CURRENT GAIN vs.
COLLECTOR CURRENT

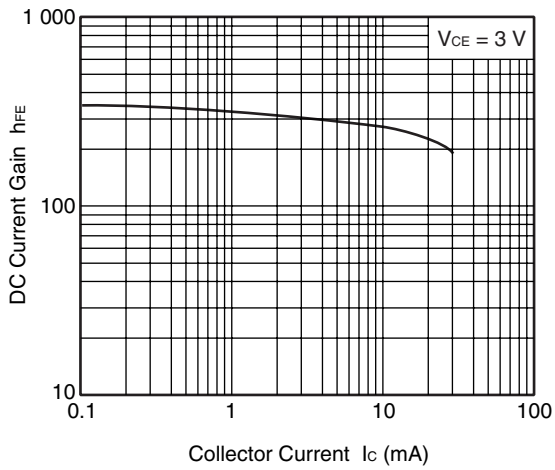

Remark The graphs indicate nominal characteristics.

GAIN BANDWIDTH PRODUCT vs. COLLECTOR CURRENT

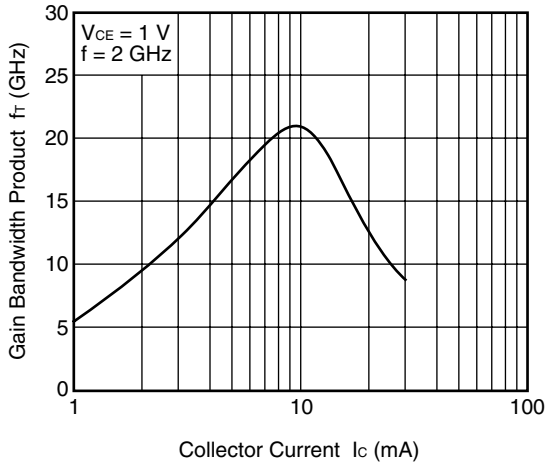

GAIN BANDWIDTH PRODUCT vs. COLLECTOR CURRENT

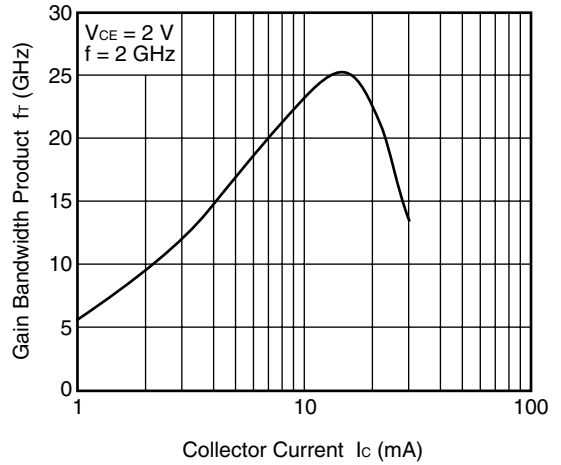

GAIN BANDWIDTH PRODUCT vs. COLLECTOR CURRENT

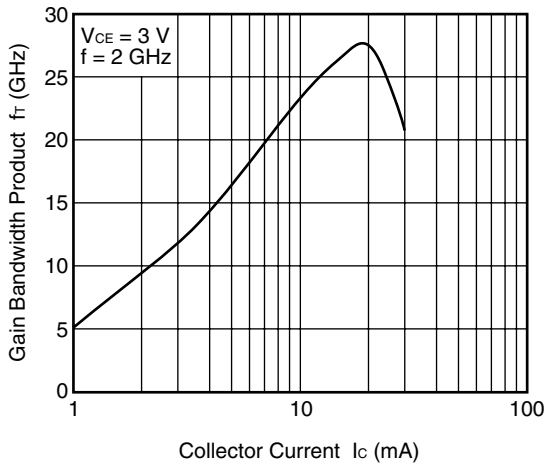

INSERTION POWER GAIN, MAG, MSG vs. FREQUENCY

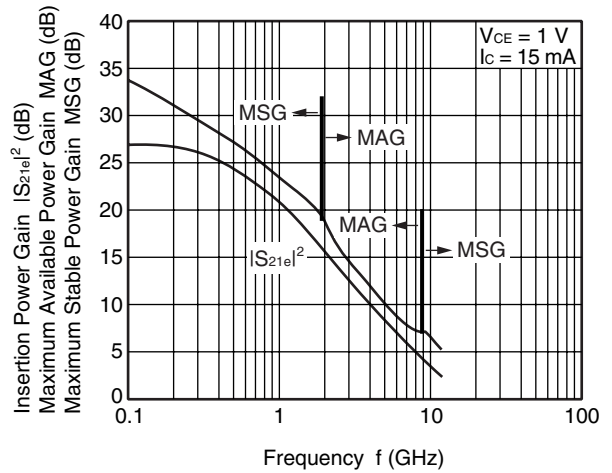

INSERTION POWER GAIN, MAG, MSG vs. FREQUENCY

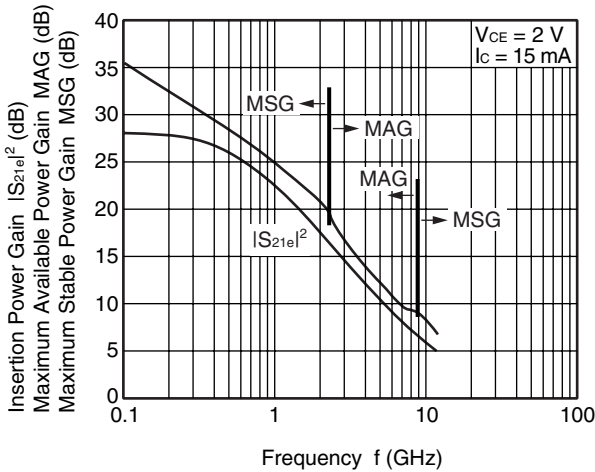

INSERTION POWER GAIN, MAG, MSG vs. FREQUENCY

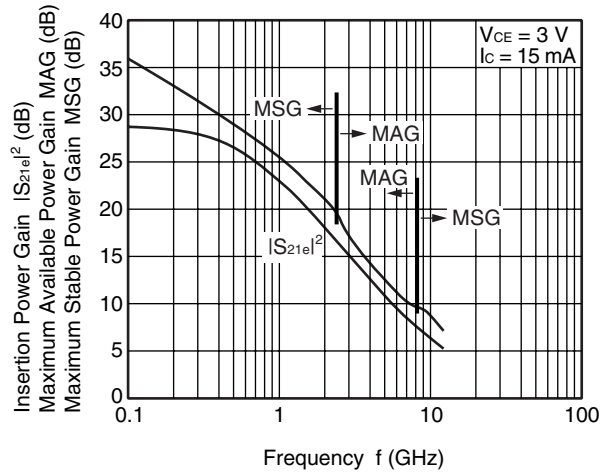

Remark The graphs indicate nominal characteristics.

INSERTION POWER GAIN, MSG
vs. COLLECTOR CURRENT

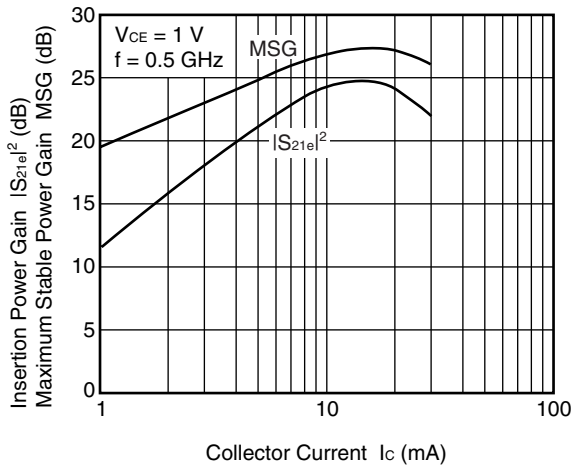

INSERTION POWER GAIN, MAG, MSG
vs. COLLECTOR CURRENT

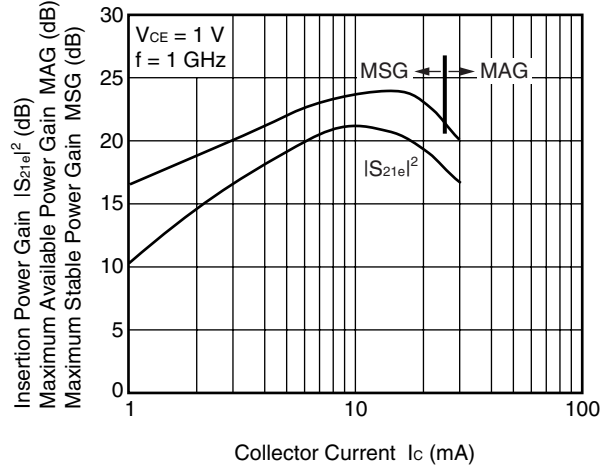

INSERTION POWER GAIN, MAG, MSG
vs. COLLECTOR CURRENT

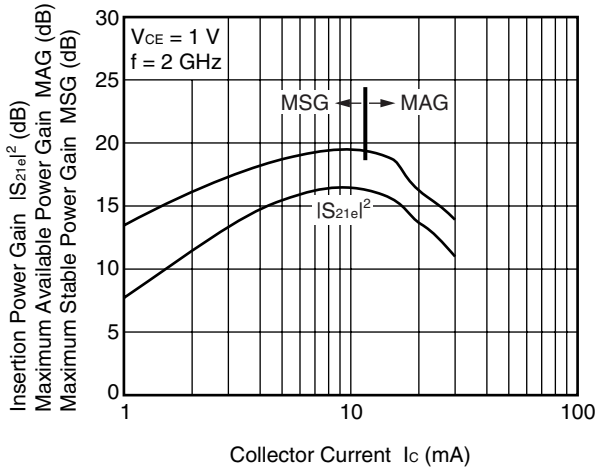

INSERTION POWER GAIN, MAG, MSG
vs. COLLECTOR CURRENT

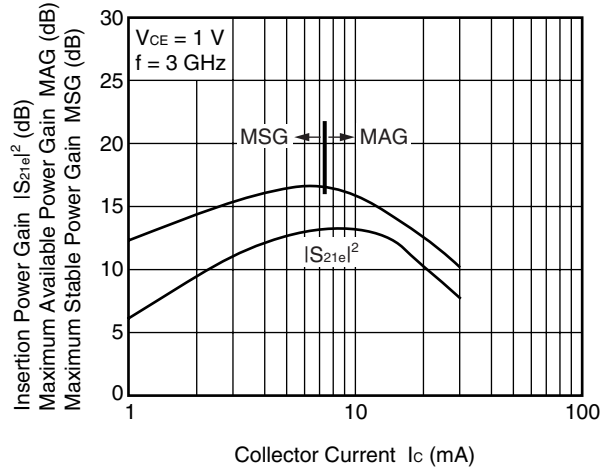

INSERTION POWER GAIN, MAG
vs. COLLECTOR CURRENT

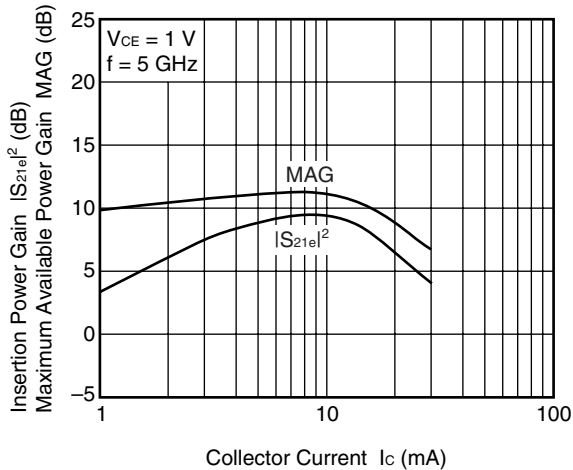

INSERTION POWER GAIN, MSG
vs. COLLECTOR CURRENT

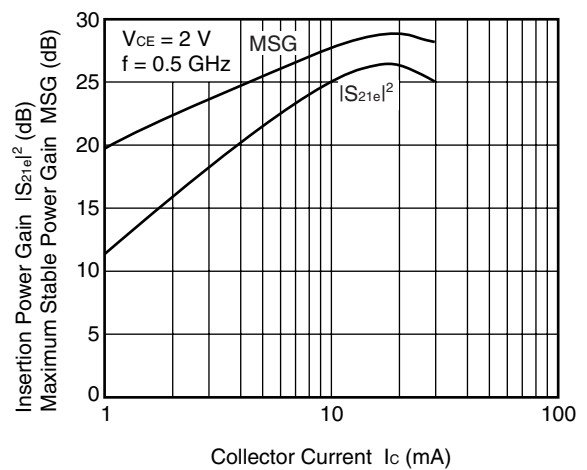

Remark The graphs indicate nominal characteristics.

INSERTION POWER GAIN, MSG
vs. COLLECTOR CURRENT

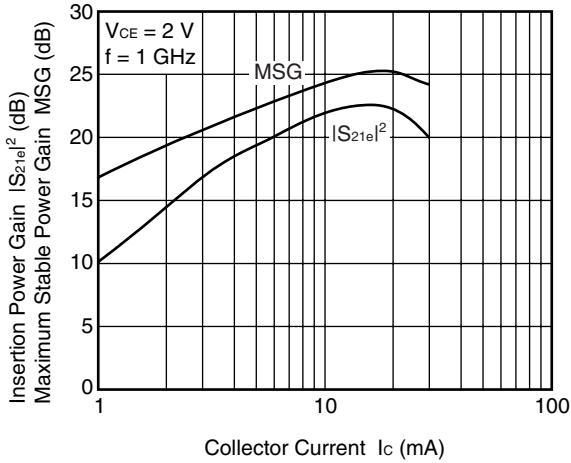

INSERTION POWER GAIN, MAG, MSG
vs. COLLECTOR CURRENT

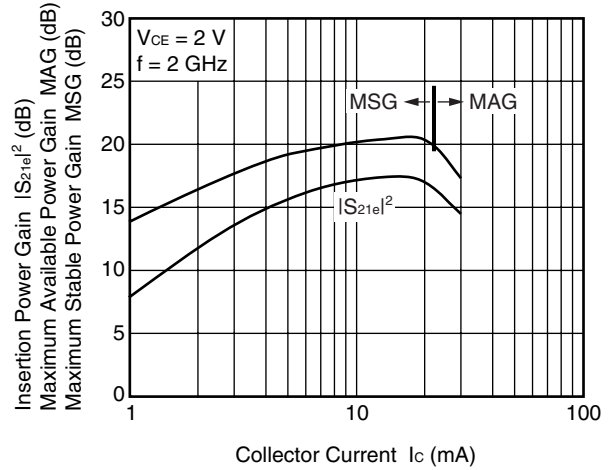

INSERTION POWER GAIN, MAG, MSG
vs. COLLECTOR CURRENT

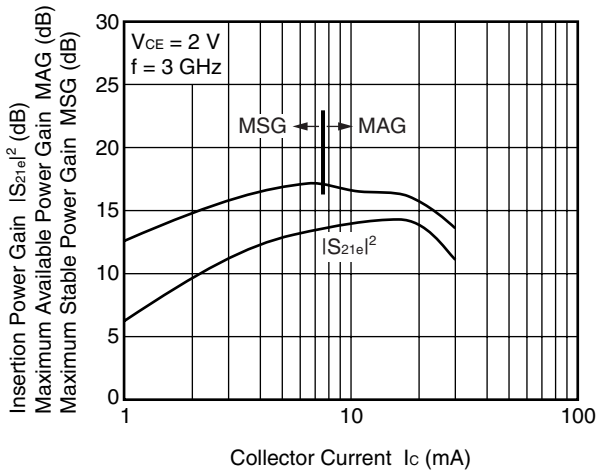

INSERTION POWER GAIN, MAG
vs. COLLECTOR CURRENT

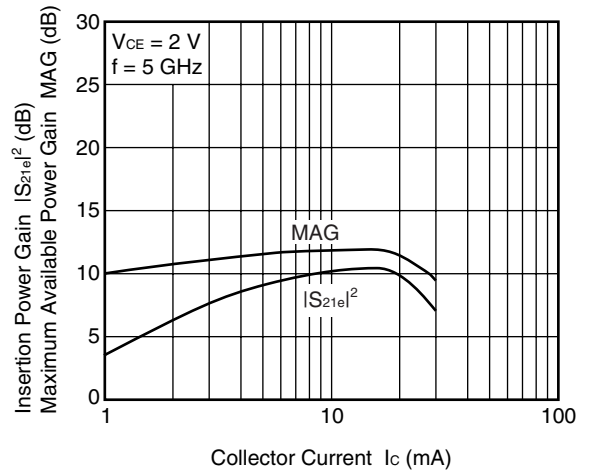

INSERTION POWER GAIN, MSG
vs. COLLECTOR CURRENT

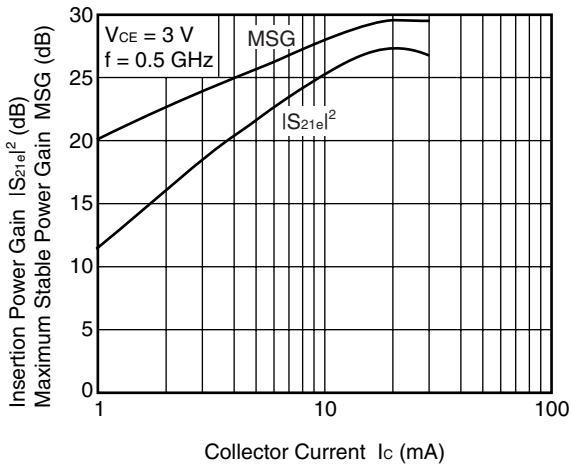

INSERTION POWER GAIN, MSG
vs. COLLECTOR CURRENT

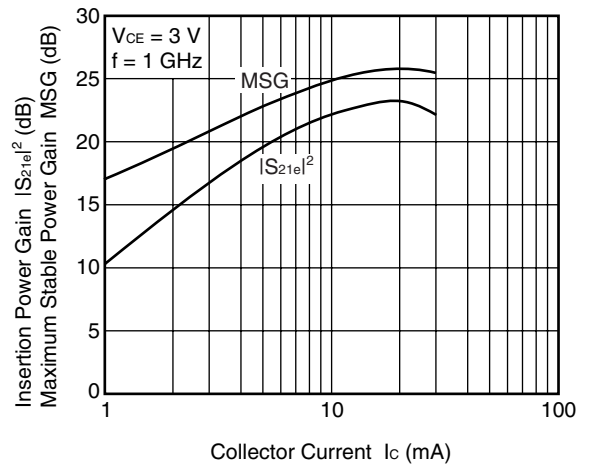

Remark The graphs indicate nominal characteristics.

INSERTION POWER GAIN, MAG, MSG
vs. COLLECTOR CURRENT

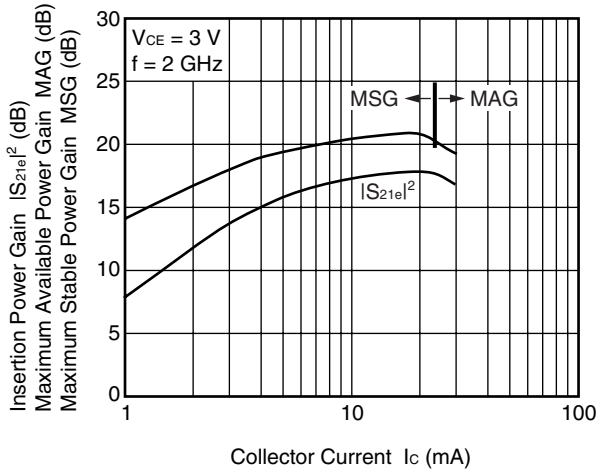

INSERTION POWER GAIN, MAG, MSG
vs. COLLECTOR CURRENT

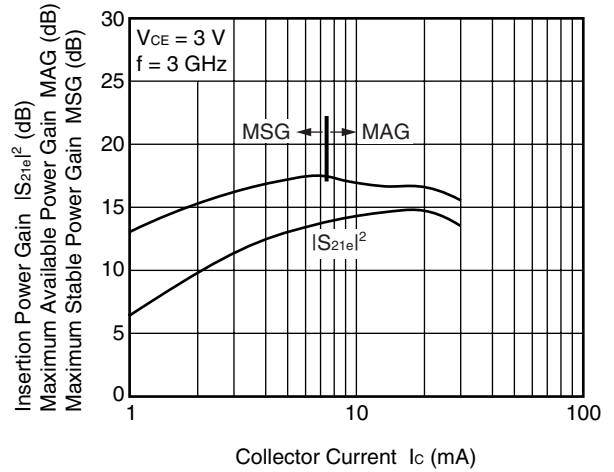

INSERTION POWER GAIN, MAG
vs. COLLECTOR CURRENT

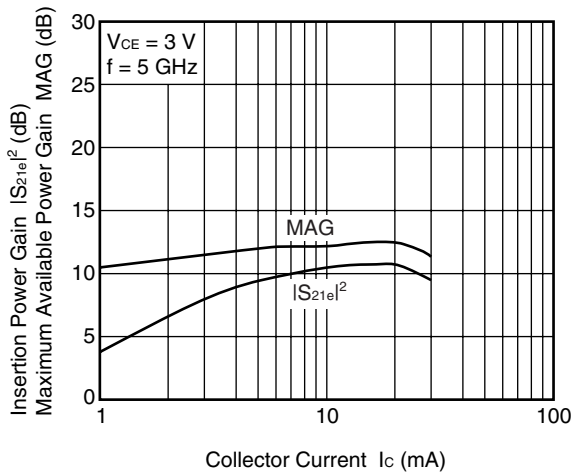

Remark The graphs indicate nominal characteristics.

OUTPUT POWER, COLLECTOR CURRENT vs. INPUT POWER

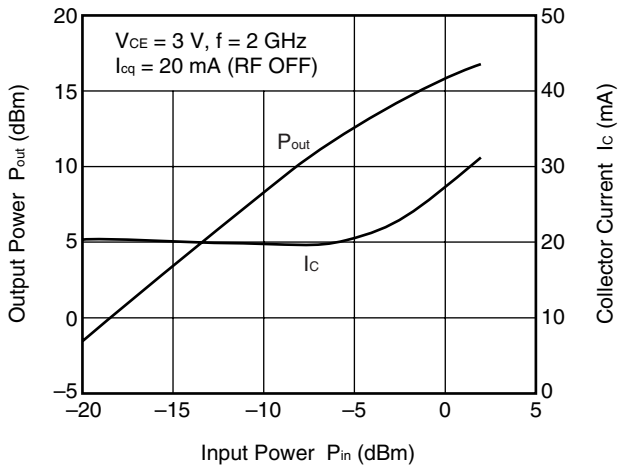

Measuring method : Measured at power matched with external sleeve tuner. (The load resistance is not inserted between the base DC power supply and Bias Tee.)

NOISE FIGURE, ASSOCIATED GAIN vs. COLLECTOR CURRENT

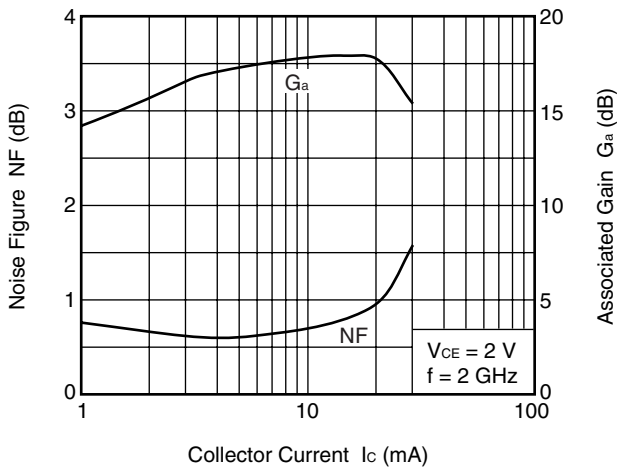

Remark The graphs indicate nominal characteristics.

<R> **S-PARAMETERS**

S-parameters and noise parameters are provided on our web site in a form (S2P) that enables direct import of the parameters to microwave circuit simulators without the need for keyboard inputs.

Click here to download S-parameters.

[Products] → [RF Devices] → [Device Parameters]

URL <http://www.renesas.com/products/microwave/>

EVALUATION CIRCUIT EXAMPLE (f = 1.575 GHz LNA)

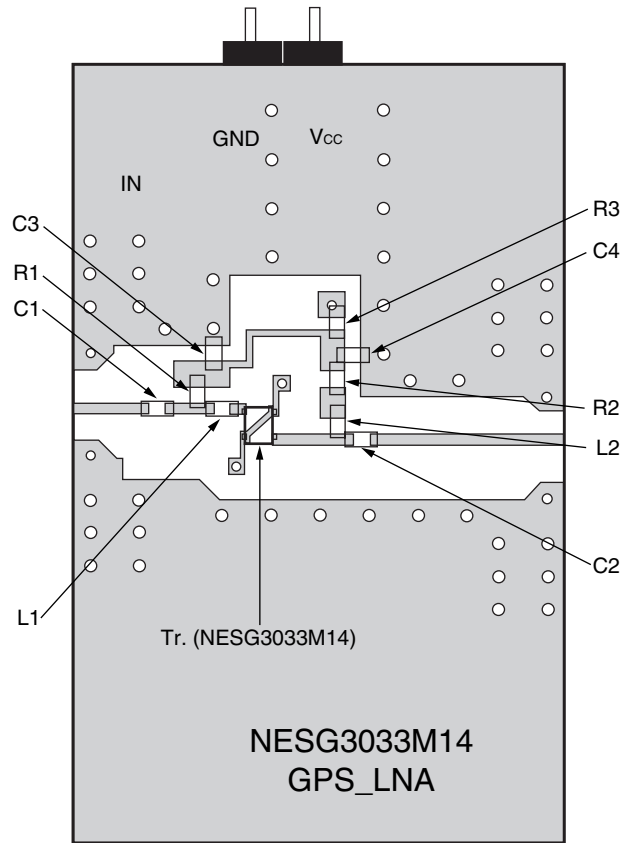

- Notes**
1. 15 × 24 mm, t = 0.2 mm double sided copper clad glass epoxy PWB.
 2. Au plated on pattern
 3. ○ : Through holes

<R> EVALUATION CIRCUIT (f = 1.575 GHz LNA)

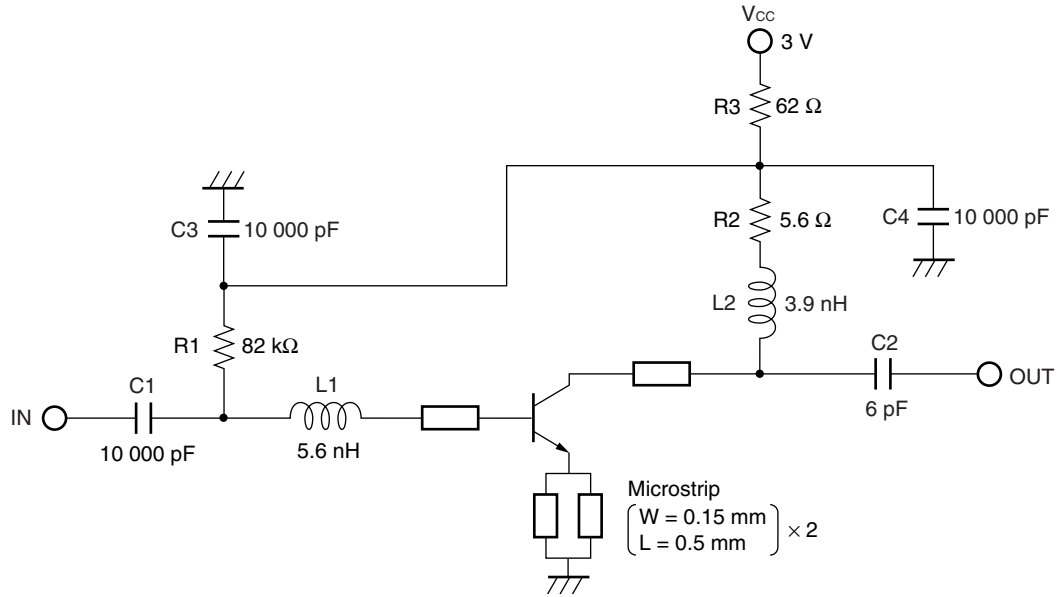

The application circuits and their parameters are for reference only and are not intended for use in actual design-ins.

<R> COMPONENT LIST

Symbol	Parts	Part Number	Maker	Value
C1, C3, C4	Chip Capacitor	GRM155B31H103KA88	Murata	10 000 pF
C2	Chip Capacitor	GRM1552C1H6R0DZ01	Murata	6 pF
L1	Chip Inductor	AML1005H5N6STS	FDK	5.6 nH
L2	Chip Inductor	AML1005H3N9STS	FDK	3.9 nH
R1	Chip Resistor	MCR01MZPJ823	ROHM	82 kΩ
R2	Chip Resistor	MCR01MZPJ5R6	ROHM	5.6 Ω
R3	Chip Resistor	MCR01MZPJ620	ROHM	62 Ω

<R> EXAMPLE OF CHARACTERISTICS FOR 1.575 GHz LNA EVALUATION BOARD

ELECTRICAL CHARACTERISTICS (T_A = +25°C, V_{CC} = 3 V, I_C = 6.1 mA, f = 1.575 GHz)

Parameter	Symbol	Value	Unit
Noise Figure	NF	0.72	dB
Gain	G _a	17.3	dB
Input Return Loss	RL _{in}	10.3	dB
Output Return Loss	RL _{out}	14.2	dB
Gain 1 dB Compression Output Power	P _{O(1 dB)}	-0.3	dBm
Input 3rd Order Distortion Interception Point	IIP ₃	0.7	dBm

TYPICAL CHARACTERISTICS (T_A = +25°C, unless otherwise specified)

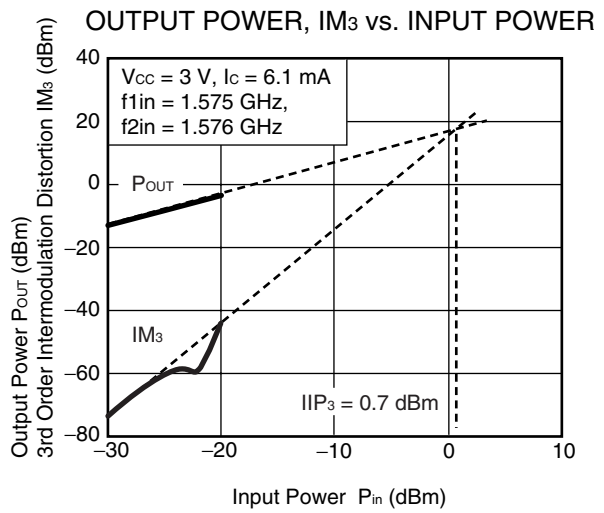
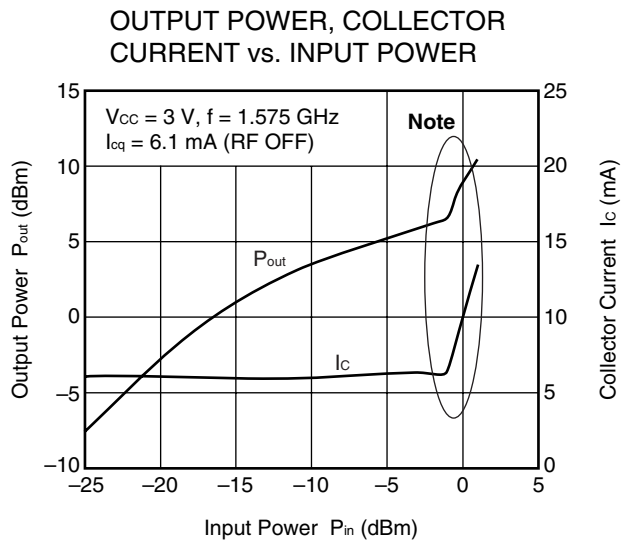

Note A current increase is seen because the ESD protection element is turned on. However, there is no influence of deterioration etc. on reliability.

Remark The graph indicates nominal characteristics.

PACKAGE DIMENSIONS

<R> 4-PIN LEAD-LESS MINIMOLD (M14, 1208 PKG) (UNIT: mm)

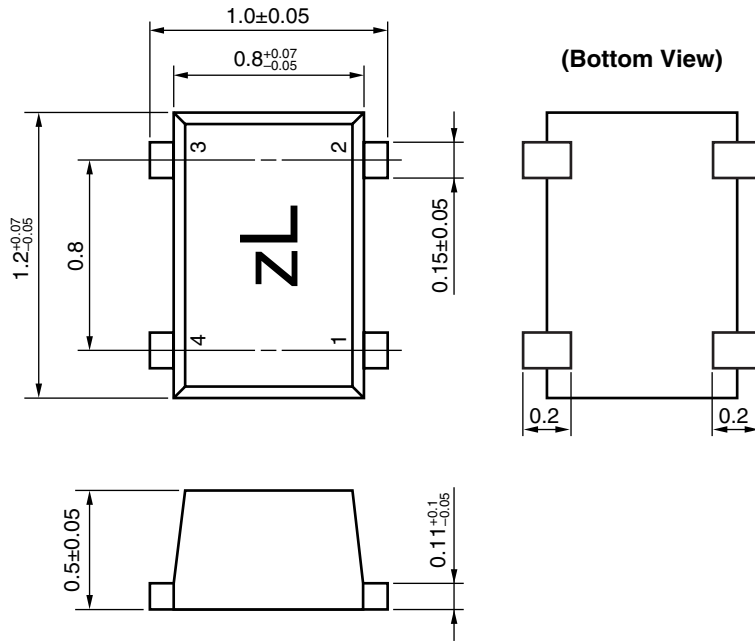

PIN CONNECTIONS

- 1. Collector
- 2. Emitter
- 3. Base
- 4. NC (Connected with Pin 2) Note

Note A NC pin is Non-connection in the mold package (When NC-pin is open state, It will get an influences of floating capacitance. Therefore, we recommend that NC pin connect to Emitter pin).

Revision History**NESG3033M14 Data Sheet**

Rev.	Date	Description	
		Page	Summary
1.00	Jul 19, 2005	–	First edition issued
2.00	Sep 11, 2007	–	Second edition issued
3.00	Sep 14, 2012	Throughout	The company name is changed to Renesas Electronics Corporation.
		p.1	Modification of ORDERING INFORMATION
		p.3	Modification of ELECTRICAL CHARACTERISTICS
		p.3	Modification of h_{FE} CLASSIFICATION
		p.10	Modification of method for obtaining S-parameters
		p.12	Modification of EVALUTION CIRCUIT
		p.12	Modification of COMPONENT LIST
		p.13	Modification of EXAMPLE OF CHARACTERISTICS FOR $f = 1.575$ GHz LNA EVALUATION BOARD
p.14	Modification of PACKAGE DIMENSIONS		

All trademarks and registered trademarks are the property of their respective owners.

Notice

1. Descriptions of circuits, software and other related information in this document are provided only to illustrate the operation of semiconductor products and application examples. You are fully responsible for the incorporation of these circuits, software, and information in the design of your equipment. Renesas Electronics assumes no responsibility for any losses incurred by you or third parties arising from the use of these circuits, software, or information.
 2. Renesas Electronics has used reasonable care in preparing the information included in this document, but Renesas Electronics does not warrant that such information is error free. Renesas Electronics assumes no liability whatsoever for any damages incurred by you resulting from errors in or omissions from the information included herein.
 3. Renesas Electronics does not assume any liability for infringement of patents, copyrights, or other intellectual property rights of third parties by or arising from the use of Renesas Electronics products or technical information described in this document. No license, express, implied or otherwise, is granted hereby under any patents, copyrights or other intellectual property rights of Renesas Electronics or others.
 4. You should not alter, modify, copy, or otherwise misappropriate any Renesas Electronics product, whether in whole or in part. Renesas Electronics assumes no responsibility for any losses incurred by you or third parties arising from such alteration, modification, copy or otherwise misappropriation of Renesas Electronics product.
 5. Renesas Electronics products are classified according to the following two quality grades: "Standard" and "High Quality". The recommended applications for each Renesas Electronics product depends on the product's quality grade, as indicated below.
"Standard": Computers; office equipment; communications equipment; test and measurement equipment; audio and visual equipment; home electronic appliances; machine tools; personal electronic equipment; and industrial robots etc.
"High Quality": Transportation equipment (automobiles, trains, ships, etc.); traffic control systems; anti-disaster systems; anti-crime systems; and safety equipment etc.
Renesas Electronics products are neither intended nor authorized for use in products or systems that may pose a direct threat to human life or bodily injury (artificial life support devices or systems, surgical implantations etc.), or may cause serious property damages (nuclear reactor control systems, military equipment etc.). You must check the quality grade of each Renesas Electronics product before using it in a particular application. You may not use any Renesas Electronics product for any application for which it is not intended. Renesas Electronics shall not be in any way liable for any damages or losses incurred by you or third parties arising from the use of any Renesas Electronics product for which the product is not intended by Renesas Electronics.
 6. You should use the Renesas Electronics products described in this document within the range specified by Renesas Electronics, especially with respect to the maximum rating, operating supply voltage range, movement power voltage range, heat radiation characteristics, installation and other product characteristics. Renesas Electronics shall have no liability for malfunctions or damages arising out of the use of Renesas Electronics products beyond such specified ranges.
 7. Although Renesas Electronics endeavors to improve the quality and reliability of its products, semiconductor products have specific characteristics such as the occurrence of failure at a certain rate and malfunctions under certain use conditions. Further, Renesas Electronics products are not subject to radiation resistance design. Please be sure to implement safety measures to guard them against the possibility of physical injury, and injury or damage caused by fire in the event of the failure of a Renesas Electronics product, such as safety design for hardware and software including but not limited to redundancy, fire control and malfunction prevention, appropriate treatment for aging degradation or any other appropriate measures. Because the evaluation of microcomputer software alone is very difficult, please evaluate the safety of the final products or systems manufactured by you.
 8. Please contact a Renesas Electronics sales office for details as to environmental matters such as the environmental compatibility of each Renesas Electronics product. Please use Renesas Electronics products in compliance with all applicable laws and regulations that regulate the inclusion or use of controlled substances, including without limitation, the EU RoHS Directive. Renesas Electronics assumes no liability for damages or losses occurring as a result of your noncompliance with applicable laws and regulations.
 9. Renesas Electronics products and technology may not be used for or incorporated into any products or systems whose manufacture, use, or sale is prohibited under any applicable domestic or foreign laws or regulations. You should not use Renesas Electronics products or technology described in this document for any purpose relating to military applications or use by the military, including but not limited to the development of weapons of mass destruction. When exporting the Renesas Electronics products or technology described in this document, you should comply with the applicable export control laws and regulations and follow the procedures required by such laws and regulations.
 10. It is the responsibility of the buyer or distributor of Renesas Electronics products, who distributes, disposes of, or otherwise places the product with a third party, to notify such third party in advance of the contents and conditions set forth in this document, Renesas Electronics assumes no responsibility for any losses incurred by you or third parties as a result of unauthorized use of Renesas Electronics products.
 11. This document may not be reproduced or duplicated in any form, in whole or in part, without prior written consent of Renesas Electronics.
 12. Please contact a Renesas Electronics sales office if you have any questions regarding the information contained in this document or Renesas Electronics products, or if you have any other inquiries.
- (Note 1) "Renesas Electronics" as used in this document means Renesas Electronics Corporation and also includes its majority-owned subsidiaries.
(Note 2) "Renesas Electronics product(s)" means any product developed or manufactured by or for Renesas Electronics.



SALES OFFICES

Renesas Electronics Corporation

<http://www.renesas.com>

Refer to "<http://www.renesas.com/>" for the latest and detailed information.

California Eastern Laboratories, Inc.
4590 Patrick Henry Drive, Santa Clara, California 95054, U.S.A.
Tel: +1-408-919-2500, Fax: +1-408-988-0279

Renesas Electronics Europe Limited
Dukes Meadow, Millboard Road, Bourne End, Buckinghamshire, SL8 5FH, U.K
Tel: +44-1628-651-700, Fax: +44-1628-651-804

Renesas Electronics Europe GmbH
Arcadiastrasse 10, 40472 Düsseldorf, Germany
Tel: +49-211-65030, Fax: +49-211-6503-1327

Renesas Electronics (China) Co., Ltd.
7th Floor, Quantum Plaza, No.27 ZhiChunLu Haidian District, Beijing 100083, P.R.China
Tel: +86-10-8235-1155, Fax: +86-10-8235-7679

Renesas Electronics (Shanghai) Co., Ltd.
Unit 204, 205, AZIA Center, No.1233 Lujiazui Ring Rd., Pudong District, Shanghai 200120, China
Tel: +86-21-5877-1818, Fax: +86-21-6887-7858 / -7898

Renesas Electronics Hong Kong Limited
Unit 1601-1613, 16/F., Tower 2, Grand Century Place, 193 Prince Edward Road West, Mongkok, Kowloon, Hong Kong
Tel: +852-2886-9318, Fax: +852 2886-9022/9044

Renesas Electronics Taiwan Co., Ltd.
13F, No. 363, Fu Shing North Road, Taipei, Taiwan
Tel: +886-2-8175-9600, Fax: +886 2-8175-9670

Renesas Electronics Singapore Pte. Ltd.
80 Bendemeer Road, Unit #06-02 Hyflux Innovation Centre Singapore 339949
Tel: +65-6213-0200, Fax: +65-6213-0300

Renesas Electronics Malaysia Sdn.Bhd.
Unit 906, Block B, Menara Amcorp, Amcorp Trade Centre, No. 18, Jln Persiaran Barat, 46050 Petaling Jaya, Selangor Darul Ehsan, Malaysia
Tel: +60-3-7955-9390, Fax: +60-3-7955-9510

Renesas Electronics Korea Co., Ltd.
11F., Samik Lavied' or Bldg., 720-2 Yeoksam-Dong, Kangnam-Ku, Seoul 135-080, Korea
Tel: +82-2-558-3737, Fax: +82-2-558-5141