

Wire Wound Ceramic Chip Inductors

HQ Series

Lead-free / High Q



PRODUCT IDENTIFICATION

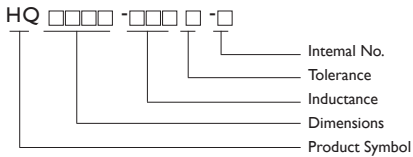

• Tolerance :G=±2%, J=±5%, K=±10%

RECOMMENDED PATTERN

Dimensions : mm

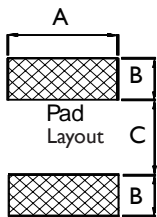

TYPE	A	B	C
HQ0805	1.78	1.02	0.76
HQ1008	2.54	1.02	1.27

Due to technical expertise of accurately winding skill, these chip inductors are designed as filtering, impedance matching, resonance and choke circuits for RF designer. The stand series as well as customer design to meet your needs of telecom & wireless products.

APPLICATIONS

RF products for cellular phone, GPS receiver, Base Station, Repeater, Wireless LAN/ Mouse/ Keyboard/ earphone, remote control, security system and other RF modules.

FEATURES

Meet SONY SS-00259's criteria for lead-free product.

Ceramic body and wire wound construction provide highest SRFs.

These ultra-compact inductors provided exceptional Q values, even at high frequencies.

Their ceramic construction delivers the highest possible SRFs as well as excellent Q values.

The non-magnetic coil form also assures the utmost in thermal stability, predictability and batch consistency.

The high current rating and low loss to fit the RF applications.

SHAPES AND DIMENSIONS

Dimensions : mm

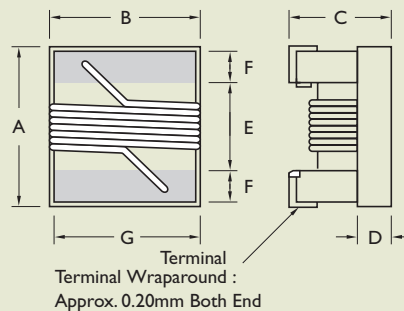

TYPE	A	B	C	D	E	F	G
HQ0805	2.29 ⁺⁰	1.73 ⁺⁰	1.52 ⁺⁰	0.50Ref	1.02	0.44	1.27
HQ1008	2.92 ⁺⁰	2.79 ⁺⁰	2.03 ⁺⁰	0.70Ref	1.52	0.51	2.03



ELECTRICAL CHARACTERISTICS : LEAD-FREE & ROHS COMPLIANCE

PART NO.	Inductance (nH)	Test Frequency (MHz)	Tolerance (±%)	Q Min	Test Frequency (MHz)	SRF Min (MHz)	RDC MAX (Ω)	Irms Max (mA)	Color
HQ0805-2N5 □ -N	2.5	250	10/5	80	1500	6000	0.020	1600	Black
HQ0805-5N6 □ -N	5.6	250	10/5	98	1500	6000	0.035	1600	Brown
HQ0805-6N2 □ -N	6.2	250	10/5	88	1000	4750	0.035	1600	Red
HQ0805-12N □ -N	12.0	250	10/5	80	1000	3000	0.045	1600	Orange
HQ0805-16N □ -N	16.0	250	10/5/2	72	500	2950	0.060	1500	Yellow
HQ0805-18N □ -N	18.0	250	10/5/2	75	500	2550	0.060	1400	Green
HQ0805-20N □ -N	20.0	250	10/5/2	70	500	2050	0.055	1400	Blue
HQ0805-27N □ -N	27.0	250	10/5/2	75	500	2000	0.070	1300	Violet
HQ0805-30N □ -N	30.0	250	10/5/2	65	500	1950	0.095	1200	Gray
HQ0805-39N □ -N	39.0	250	10/5/2	65	500	1600	0.110	1100	White
HQ0805-48N □ -N	48.0	200	10/5/2	65	500	1400	0.095	1200	Black
HQ0805-51N □ -N	51.0	200	10/5/2	65	500	1400	0.120	1000	Brown

- When ordering, please specify tolerance and packaging code. Ex :HQ0805-12NJ-N
- Tolerance : G =±2% , J =±5% , K =±10%
- Packaging : Clear Tape and Reel (Standard)
- L/Q : Agilent / HP4291A+Agilent / HP16193A
- SRF : Agilent/HP8753D / Agilent/HP4291A
- RDC : Digital Multimeter SC-7401
- Irms for a 15°C rise above 25°C ambient
- Operating Temperature Range from -40°C to 125°C

TEST INSTRUMENTS : HP4291A MATERIAL / IMPEDANCE ANALYZER

Typical L vs Frequency

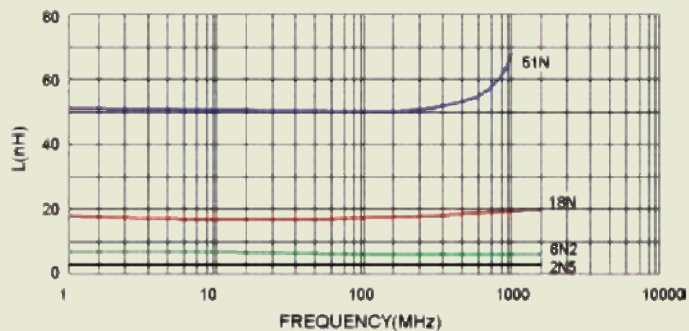

Typical Q vs Frequency

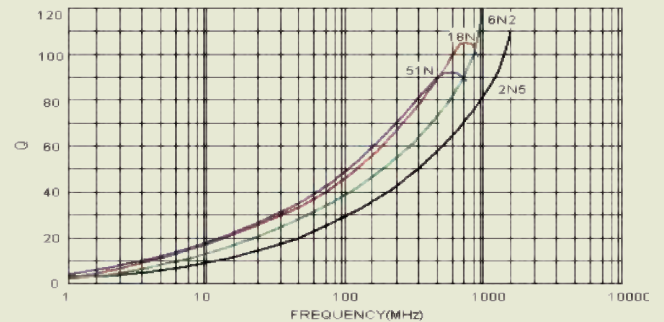



ELECTRICAL CHARACTERISTICS : LEAD-FREE & ROHS COMPLIANCE

PART NO.	INDUCTANCE (nH)	TEST FREQUENCY (MHz)	TOLERANCE (±%)	Q Min.	TEST FREQUENCY (MHz)	SRF	Rdc Max	I _{rms} Max	COLOR CODING		
									1 st	2 nd	3 rd
HQ1008-4N1 □ -N	4.1	50	10/5	75	1500	6000	0.05	1600	Black	Yellow	Black
HQ1008-10N □ -N	10.0	50	10/5	60	500	3600	0.06	1600	Brown	Black	Black
HQ1008-12N □ -N	12.0	50	10/5/2	70	500	2800	0.06	1500	Brown	Red	Black
HQ1008-18N □ -N	18.0	50	10/5/2	62	350	2700	0.07	1400	Brown	Gray	Black
HQ1008-22N □ -N	22.0	50	10/5/2	62	350	2050	0.07	1400	Red	Red	Black
HQ1008-33N □ -N	33.0	50	10/5/2	75	350	1700	0.09	1300	Orange	Orange	Black
HQ1008-39N □ -N	39.0	50	10/5/2	75	350	1300	0.09	1300	Orange	White	Black
HQ1008-47N □ -N	47.0	50	10/5/2	75	350	1450	0.12	1200	Yellow	Violet	Black
HQ1008-56N □ -N	56.0	50	10/5/2	75	350	1230	0.12	1200	Green	Blue	Black
HQ1008-68N □ -N	68.0	50	10/5/2	80	350	1150	0.13	1100	Blue	Gray	Black
HQ1008-82N □ -N	82.0	50	10/5/2	80	350	1060	0.16	1100	Gray	Red	Black
HQ1008-R10 □ -N	100.0	50	10/5/2	62	350	820	0.16	1000	Brown	Black	Brown
HQ1008-R15 □ -N	150.0	50	10/5/2	55	350	800	0.23	1000	Brown	Green	Brown

- When ordering, please specify tolerance and packaging code. Ex : HQ1008-R10J-N
- Tolerance : G =±2% , J =±5% , K =±10%
- Packaging : Clear Tape and Reel (Standard)
- L/Q : Agilent / HP4291A+Agilent / HP16193A
- SRF : Agilent/HP8753D / Agilent/HP4291A
- RDC : Digital Multimeter SC-7401
- I_{rms} for a 15°C rise above 25°C ambient
- Operating Temperature Range from -40°C to 125°C

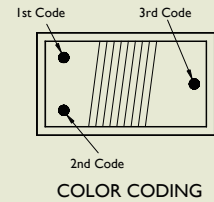

TEST INSTRUMENTS : HP4291A MATERIAL / IMPEDANCE ANALYZER

Typical L vs Frequency

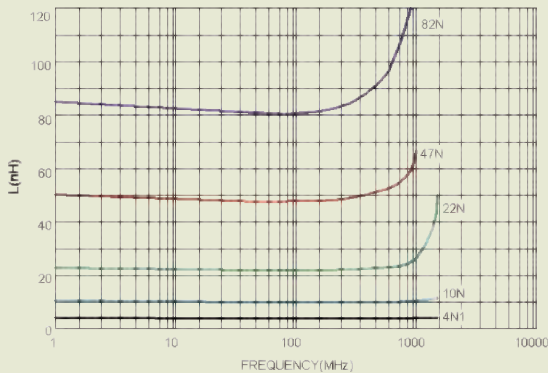

Typical Q vs Frequency

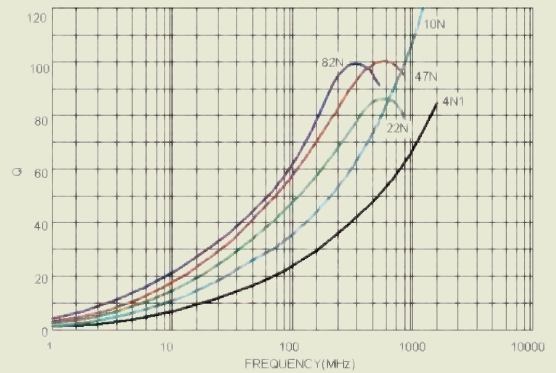

PACKAGING SPECIFICATIONS

Tape Dimensions

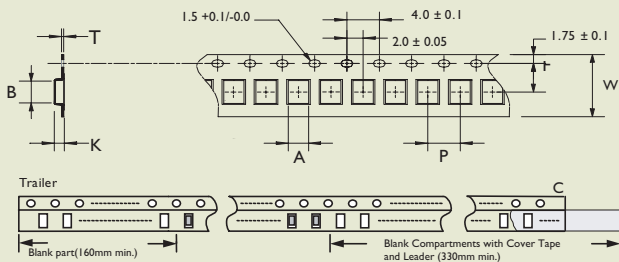

Reel Dimensions

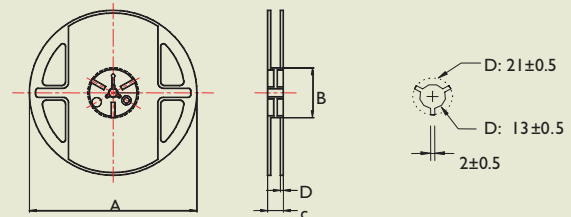

Dimensions : mm

TYPE	TAPE DIMENSIONS							REEL DIMENSIONS				QUANTITY/REEL
	A	B	T	W	P	F	K	A	B	C	D	
HQ0805	1.85	2.45	0.23	8	4	3.5	1.45	178	60	12	1.5	2000
HQ1008	2.70	2.95	0.23	8	4	3.5	2.25	178	60	12	1.5	2000



RECOMMEND SOLDERING CONDITIONS

for:CS/ CT/ LCN/ HC/ HQ/ CMM/ NL (open type)/ NLC (open type)/ LS

