

Schottky Diode Gen²

High Performance Schottky Diode
Low Loss and Soft Recovery
Common Cathode

$V_{RRM} = 150\text{ V}$
 $I_{FAV} = 2 \times 35\text{ A}$
 $V_F = 0.77\text{ V}$

Part number

DSA 70 C 150 HB

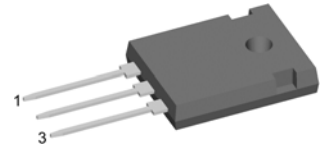
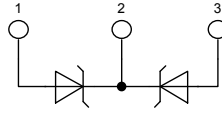

Backside: cathode

Features / Advantages:

- Very low V_f
- Extremely low switching losses
- low I_{rm} values
- Improved thermal behaviour
- High reliability circuit operation
- Low voltage peaks for reduced protection circuits
- Low noise switching

Applications:

- Rectifiers in switch mode power supplies (SMPS)
- Free wheeling diode in low voltage converters

Package:

- Housing: TO-247
- Industry standard outline
- Epoxy meets UL 94V-0
- RoHS compliant

| Symbol | Definition | Conditions | Ratings | | | Unit |
|------------|-------------------------------------|---------------------------------------|---------|------|------|------|
| | | | min. | typ. | max. | |
| V_{RRM} | max. repetitive reverse voltage | | | | 150 | V |
| I_R | reverse current | $V_R = 150\text{ V}$ | | | 0.68 | mA |
| | | $V_R = 150\text{ V}$ | | | 7.5 | mA |
| V_F | forward voltage | $I_F = 35\text{ A}$ | | | 0.90 | V |
| | | $I_F = 70\text{ A}$ | | | 1.06 | V |
| | | $I_F = 35\text{ A}$ | | | 0.77 | V |
| | | $I_F = 70\text{ A}$ | | | 0.94 | V |
| I_{FAV} | average forward current | rectangular d = 0.5 | | | 35 | A |
| V_{F0} | threshold voltage | } for power loss calculation only | | | 0.53 | V |
| r_F | slope resistance | | | | 4.9 | mΩ |
| R_{thJC} | thermal resistance junction to case | | | | 0.70 | K/W |
| T_{VJ} | virtual junction temperature | | -55 | | 175 | °C |
| P_{tot} | total power dissipation | | | | 215 | W |
| I_{FSM} | max. forward surge current | t = 10 ms (50 Hz), sine | | | 420 | A |
| C_J | junction capacitance | $V_R = 24\text{ V}; f = 1\text{ MHz}$ | | 226 | | pF |

| Symbol | Definition | Conditions | Ratings | | | Unit |
|---------------|-------------------------------------|----------------------------|---------|------|------|------|
| | | | min. | typ. | max. | |
| I_{RMS} | RMS current | per terminal ¹⁾ | | | 50 | A |
| R_{thCH} | thermal resistance case to heatsink | | | 0.25 | | K/W |
| T_{stg} | storage temperature | | -55 | | 150 | °C |
| Weight | | | | 6 | | g |
| M_D | mounting torque | | 0.8 | | 1.2 | Nm |
| F_C | mounting force with clip | | 20 | | 120 | N |

¹⁾ I_{RMS} is typically limited by the pin-to-chip resistance (1); or by the current capability of the chip (2).
 In case of (1) and a common cathode/anode configuration with a non-isolated backside, the current capability can be increased by connecting the backside.

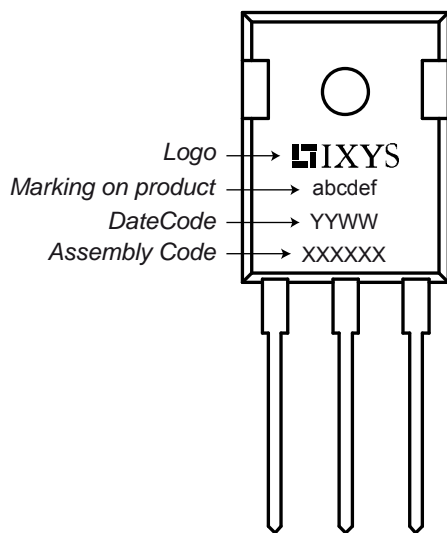
Product Marking

Part number

- D = Diode
- S = Schottky Diode
- A = low VF
- 70 = Current Rating [A]
- C = Common Cathode
- 150 = Reverse Voltage [V]
- HB = TO-247AD (3)

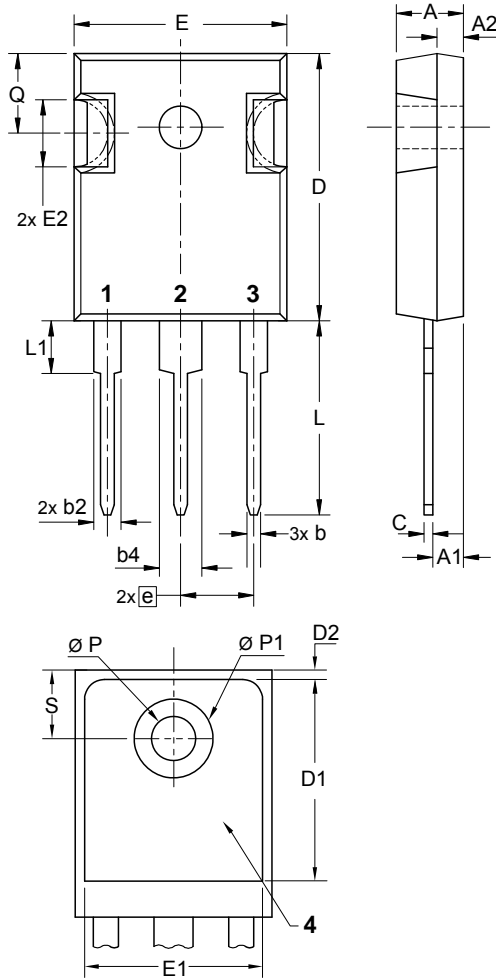
| Ordering | Part Name | Marking on Product | Delivering Mode | Base Qty | Code Key |
|----------|-----------------|--------------------|-----------------|----------|----------|
| Standard | DSA 70 C 150 HB | DSA70C150HB | Tube | 30 | 506708 |

Outlines TO-247

| Sym. | Inches | | Millimeter | |
|------|-----------|-------|------------|-------|
| | min. | max. | min. | max. |
| A | 0.185 | 0.209 | 4.70 | 5.30 |
| A1 | 0.087 | 0.102 | 2.21 | 2.59 |
| A2 | 0.059 | 0.098 | 1.50 | 2.49 |
| D | 0.819 | 0.845 | 20.79 | 21.45 |
| E | 0.610 | 0.640 | 15.48 | 16.24 |
| E2 | 0.170 | 0.216 | 4.31 | 5.48 |
| e | 0.215 BSC | | 5.46 BSC | |
| L | 0.780 | 0.800 | 19.80 | 20.30 |
| L1 | - | 0.177 | - | 4.49 |
| Ø P | 0.140 | 0.144 | 3.55 | 3.65 |
| Q | 0.212 | 0.244 | 5.38 | 6.19 |
| S | 0.242 BSC | | 6.14 BSC | |
| b | 0.039 | 0.055 | 0.99 | 1.40 |
| b2 | 0.065 | 0.094 | 1.65 | 2.39 |
| b4 | 0.102 | 0.135 | 2.59 | 3.43 |
| c | 0.015 | 0.035 | 0.38 | 0.89 |
| D1 | 0.515 | - | 13.07 | - |
| D2 | 0.020 | 0.053 | 0.51 | 1.35 |
| E1 | 0.530 | - | 13.45 | - |
| Ø P1 | - | 0.29 | - | 7.39 |

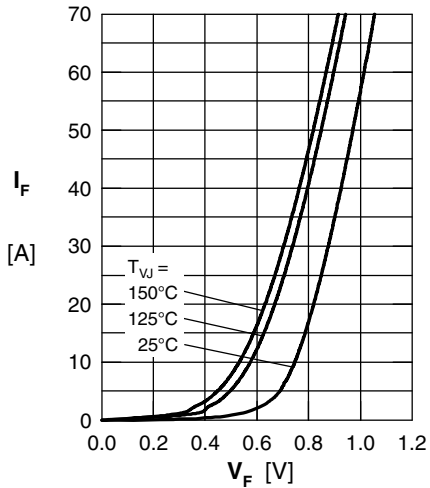

Fig. 1 Maximum forward voltage drop characteristics

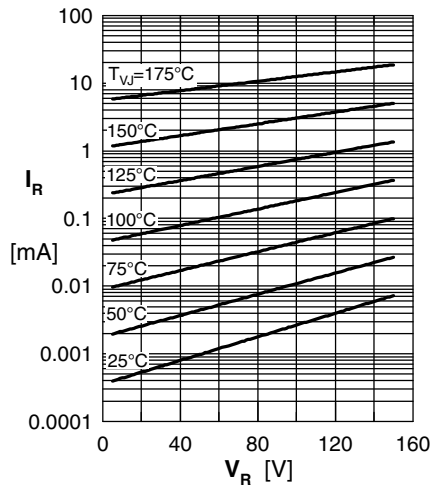

Fig. 2 Typ. reverse current I_R vs. reverse voltage V_R

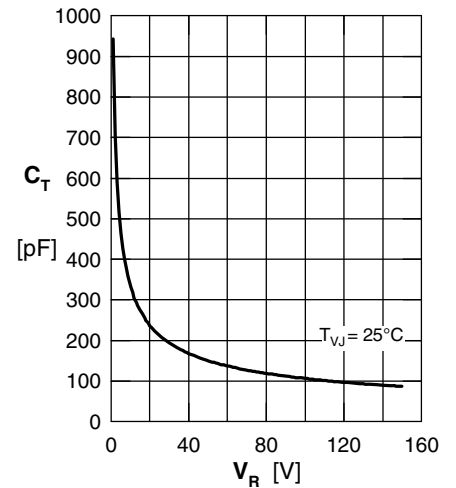

Fig. 3 Typ. junction capacitance C_T vs. reverse voltage V_R

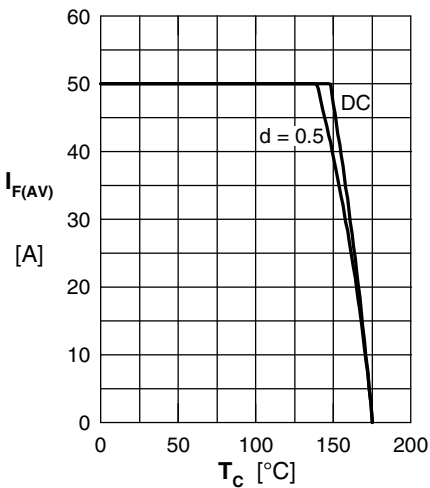

Fig. 4 Average forward current $I_{F(AV)}$ vs. case temperature T_C

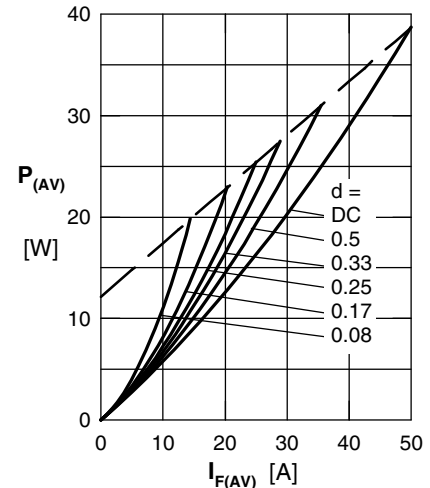

Fig. 5 Forward power loss characteristics

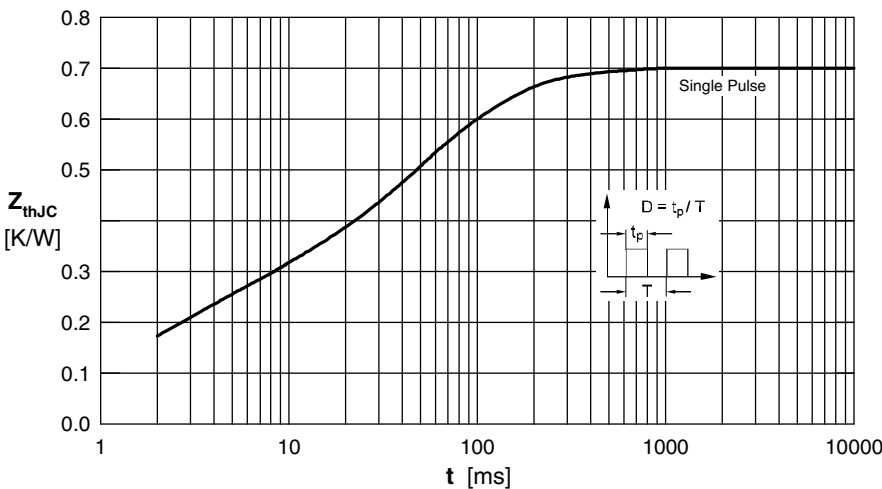

Fig. 6 Transient thermal impedance junction to case

Note: All curves are per diode