



STD3PK50Z

P-channel 500 V, 3 Ω typ., 2.8 A Zener-protected SuperMESH™ Power MOSFET in a DPAK package

Datasheet — production data

Features

Order code	V _{DSS}	R _{DS(on)} max	I _D	P _{TOT}
STD3PK50Z	500 V	< 4 Ω	2.8 A	70 W

- Gate charge minimized
- Extremely high dv/dt capability
- 100% avalanche tested
- Very low intrinsic capacitance
- Improved ESD capability

Applications

- Switching applications

Description

This device is a P-channel Zener-protected Power MOSFET developed using STMicroelectronics' SuperMESH™ technology, achieved through optimization of ST's well established strip-based PowerMESH™ layout. In addition to a significant reduction in on-resistance, this device is designed to ensure a high level of dv/dt capability for the most demanding applications.

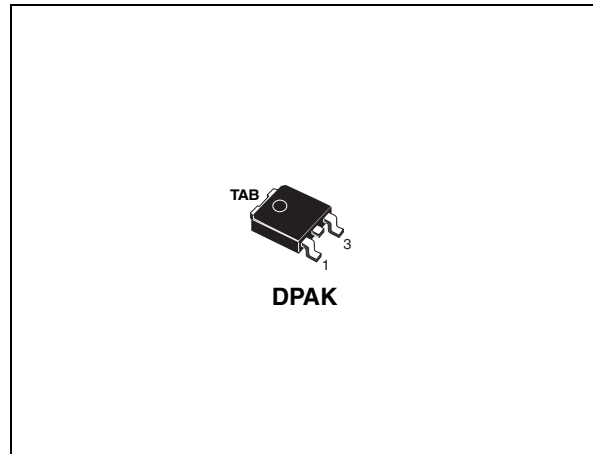

Figure 1. Internal schematic diagram

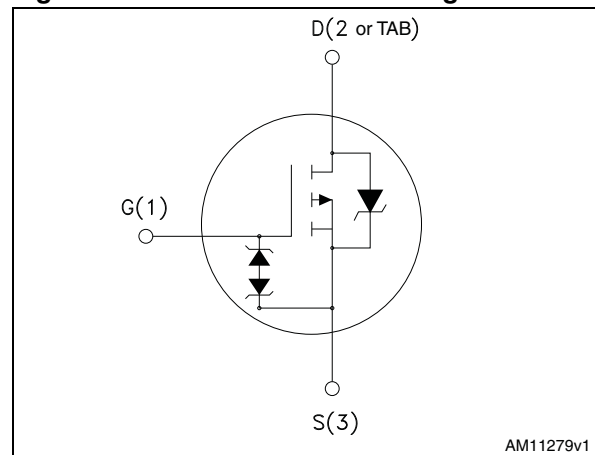

Table 1. Device summary

Order code	Marking	Package	Packaging
STD3PK50Z	3PK50Z	DPAK	Tape and reel

Note: For the P-channel Power MOSFETs actual polarity of voltages and current has to be reversed.

Contents

1	Electrical ratings	3
2	Electrical characteristics	4
2.1	Electrical characteristics (curves)	6
3	Test circuits	8
4	Package mechanical data	9
5	Packaging mechanical data	12
6	Revision history	14



1 Electrical ratings

Table 2. Absolute maximum ratings

Symbol	Parameter	Value	Unit
V_{DS}	Drain source voltage	500	V
V_{GS}	Gate- source voltage	± 30	V
I_D	Drain current (continuous) at $T_C = 25\text{ }^\circ\text{C}$	2.8	A
I_D	Drain current (continuous) at $T_C = 100\text{ }^\circ\text{C}$	1.8	A
$I_{DM}^{(1)}$	Drain current (pulsed)	11	A
P_{TOT}	Total dissipation at $T_C = 25\text{ }^\circ\text{C}$	85	W
I_{AR}	Max current during repetitive or single pulse avalanche (pulse width limited by T_{jmax})	2.8	A
E_{AS}	Single pulse avalanche energy (starting $T_J = 25\text{ }^\circ\text{C}$, $I_D = I_{AS}$, $V_{DD} = 50\text{ V}$)	200	mJ
$dv/dt^{(2)}$	Peak diode recovery voltage slope	40	V/ns
ESD	Gate-source human body model (R = 1,5 k, C = 100 pF)	3	kV
T_j T_{stg}	Operating junction temperature Storage temperature	- 55 to 150	$^\circ\text{C}$

1. Pulse width limited by safe operating area.

2. $I_{SD} \leq 2.8\text{ A}$, $di/dt \leq 200\text{ A}/\mu\text{s}$, $V_{Peak} \leq V_{(BR)DSS}$

Table 3. Thermal data

Symbol	Parameter	Value	Unit
Rthj-case	Thermal resistance junction-case max	1.47	$^\circ\text{C}/\text{W}$
Rthj-pcb	Thermal resistance junction-pcb max	50	$^\circ\text{C}/\text{W}$

Note: For the P-channel Power MOSFETs actual polarity of voltages and current has to be reversed.

2 Electrical characteristics

($T_{CASE} = 25\text{ °C}$ unless otherwise specified)

Table 4. On/off states

Symbol	Parameter	Test conditions	Min.	Typ.	Max.	Unit
$V_{(BR)DSS}$	Drain-source breakdown voltage	$I_D = 1\text{ mA}$, $V_{GS} = 0$	500			V
I_{DSS}	Zero gate voltage drain current ($V_{GS} = 0$)	$V_{DS} = 500\text{ V}$, $V_{DS} = 500\text{ V}$, $T_C = 125\text{ °C}$			1 100	μA μA
I_{GSS}	Gate body leakage current ($V_{DS} = 0$)	$V_{GS} = \pm 25\text{ V}$			± 10	μA
$V_{GS(th)}$	Gate threshold voltage	$V_{DS} = V_{GS}$, $I_D = 100\text{ }\mu\text{A}$	3	3.75	4.5	V
$R_{DS(on)}$	Static drain-source on-resistance	$V_{GS} = 10\text{ V}$, $I_D = 1.4\text{ A}$		3	4	Ω

Table 5. Dynamic

Symbol	Parameter	Test conditions	Min.	Typ.	Max.	Unit
C_{iss}	Input capacitance	$V_{DS} = 50\text{ V}$, $f = 1\text{ MHz}$, $V_{GS} = 0$		530		pF
C_{oss}	Output capacitance		-	50	-	pF
C_{rss}	Reverse transfer capacitance				25	pF
$C_{o(tr)}^{(1)}$	Equivalent capacitance time related	$V_{GS} = 0$, $V_{DS} = 0\text{ to }400\text{ V}$	-	32	-	pF
$C_{o(er)}^{(2)}$	Equivalent capacitance energy related		-	23	-	pF
R_G	Intrinsic gate resistance	$f = 1\text{ MHz}$ open drain	-	4.7	-	Ω
Q_g	Total gate charge	$V_{DD} = 400\text{ V}$, $I_D = 2.8\text{ A}$ $V_{GS} = 10\text{ V}$ (see Figure 14)		29		nC
Q_{gs}	Gate-source charge		-	4.3	-	nC
Q_{gd}	Gate-drain charge				15	nC

1. Time related is defined as a constant equivalent capacitance giving the same charging time as C_{oss} when V_{DS} increases from 0 to 80% V_{DSS}
2. energy related is defined as a constant equivalent capacitance giving the same stored energy as C_{oss} when V_{DS} increases from 0 to 80% V_{DSS}

Note: For the P-channel Power MOSFETs actual polarity of voltages and current has to be reversed.

Table 6. Switching times

Symbol	Parameter	Test conditions	Min.	Typ.	Max.	Unit
$t_{d(on)}$	Turn-on delay time	$V_{DD} = 250\text{ V}$, $I_D = 1.4\text{ A}$, $R_G = 4.7\ \Omega$, $V_{GS} = 10\text{ V}$ (see Figure 13)		16		ns
t_r	Rise time			15		ns
$t_{d(off)}$	Turn-off delay time			46		ns
t_f	Fall time			26		ns

Table 7. Source drain diode

Symbol	Parameter	Test conditions	Min.	Typ.	Max.	Unit
I_{SD}	Source-drain current				2.8	mA
I_{SDM}	Source-drain current (pulsed)				11.2	A
$V_{SD}^{(1)}$	Forward on voltage	$I_{SD} = 2.8\text{ A}$, $V_{GS} = 0$			1.5	V
t_{rr}	Reverse recovery time	$I_{SD} = 2.8\text{ A}$, $V_{DD} = 60\text{ V}$ $di/dt = 100\text{ A}/\mu\text{s}$, (see Figure 15)		220		ns
Q_{rr}	Reverse recovery charge			1600		nC
I_{RRM}	Reverse recovery current			14		A
t_{rr}	Reverse recovery time	$I_{SD} = 2.8\text{ A}$, $V_{DD} = 60\text{ V}$ $di/dt = 100\text{ A}/\mu\text{s}$, $T_J = 150\text{ }^\circ\text{C}$ (see Figure 15)		280		ns
Q_{rr}	Reverse recovery charge			2100		nC
I_{RRM}	Reverse recovery current			15		A

1. Pulsed: pulse duration = 300 μs , duty cycle 1.5%

Table 8. Gate-source Zener diode

Symbol	Parameter	Test conditions	Min.	Typ.	Max.	Unit
BV_{GSO}	Gate-source breakdown voltage	$I_{gs} \pm 1\text{ mA}$, (open drain)	30		-	V

The built-in back- to-back Zener diodes have specifically been designed to enhance not only the device's ESD capability, but also to make them safely absorb possible voltage transients that may occasionally be applied from gate to source. In this respect the Zener voltage is appropriate to achieve an efficient and cost-effective intervention to protect the device's integrity. These integrated Zener diodes thus avoid the usage of external components.

Note: For the P-channel Power MOSFETs actual polarity of voltages and current has to be reversed.

2.1 Electrical characteristics (curves)

Figure 2. Safe operating area

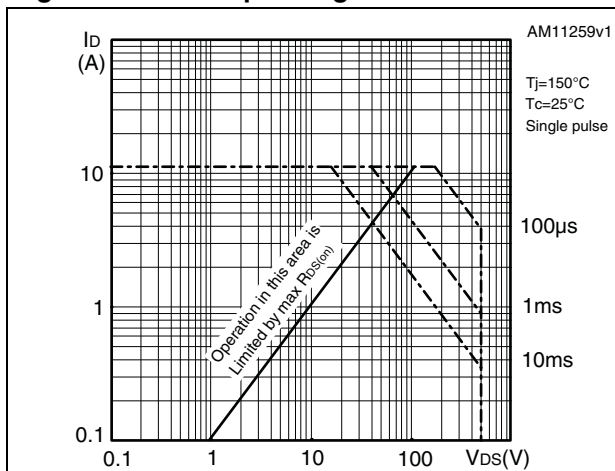

Figure 3. Thermal impedance

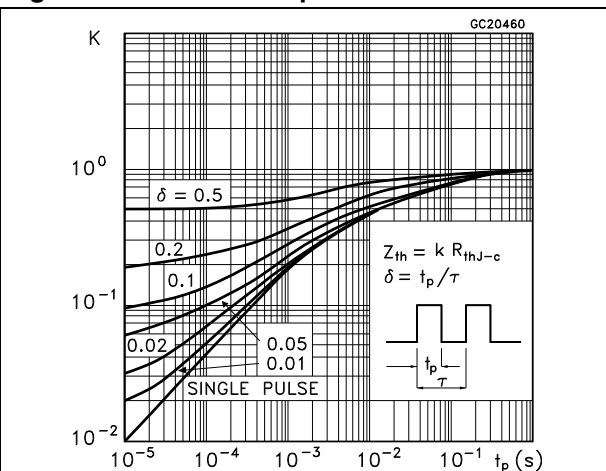

Figure 4. Output characteristics

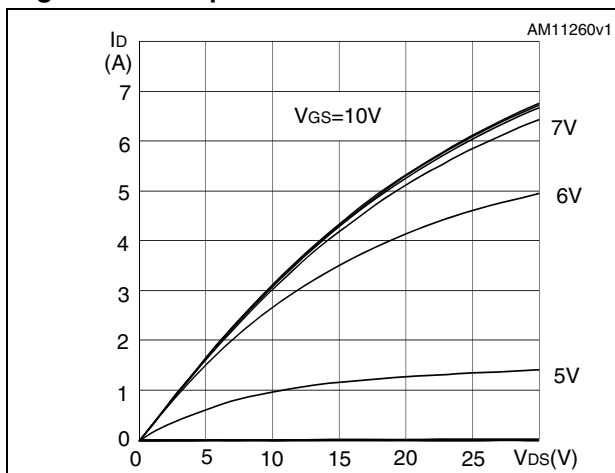

Figure 5. Transfer characteristics

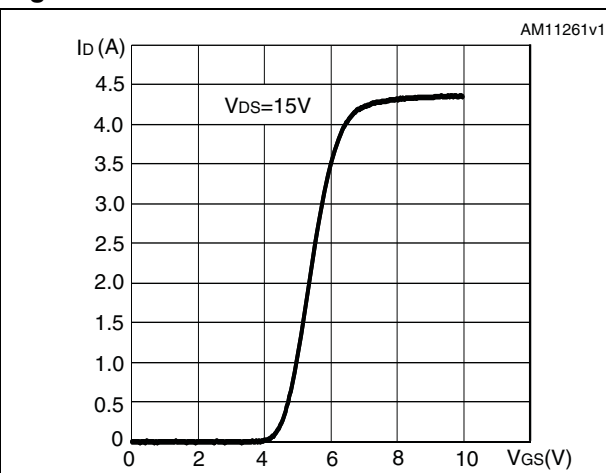

Figure 6. Normalized $B_{V_{DSS}}$ vs temperature

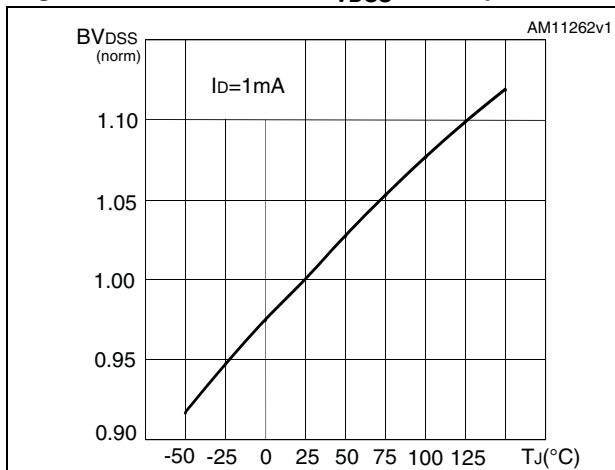

Figure 7. Static drain-source on-resistance

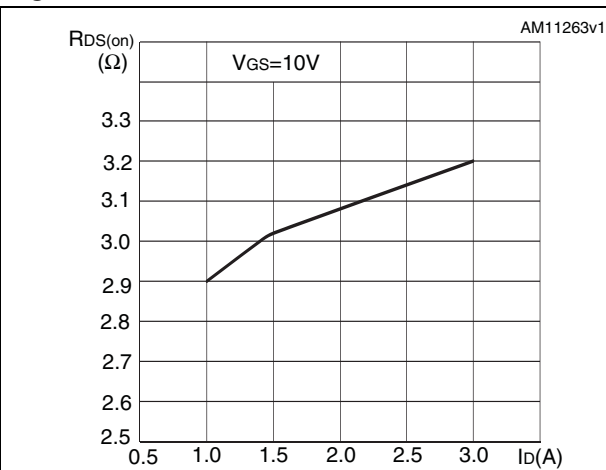

Figure 8. Gate charge vs gate-source voltage Figure 9. Capacitance variations

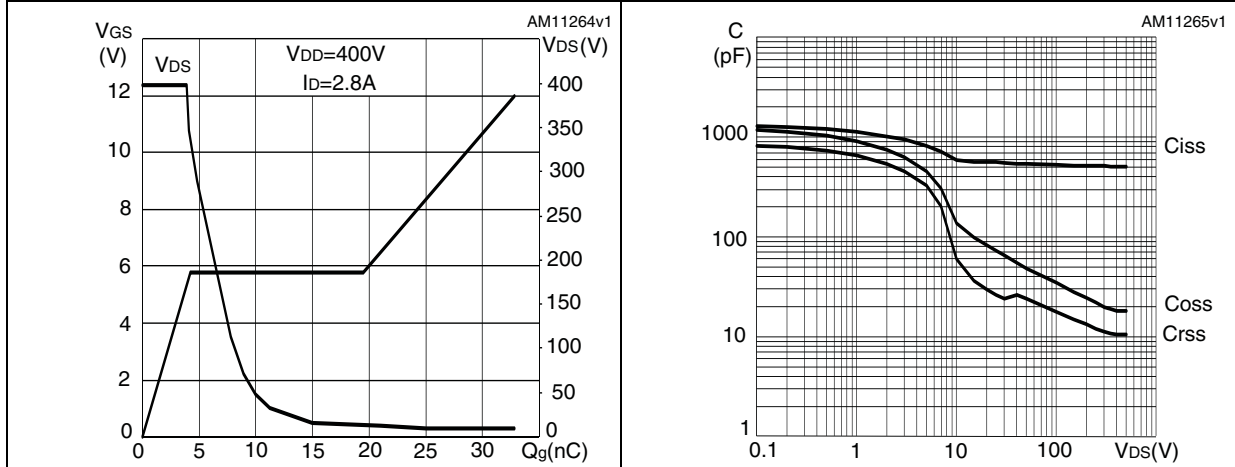

Figure 10. Normalized gate threshold voltage vs temperature Figure 11. Normalized on-resistance vs temperature

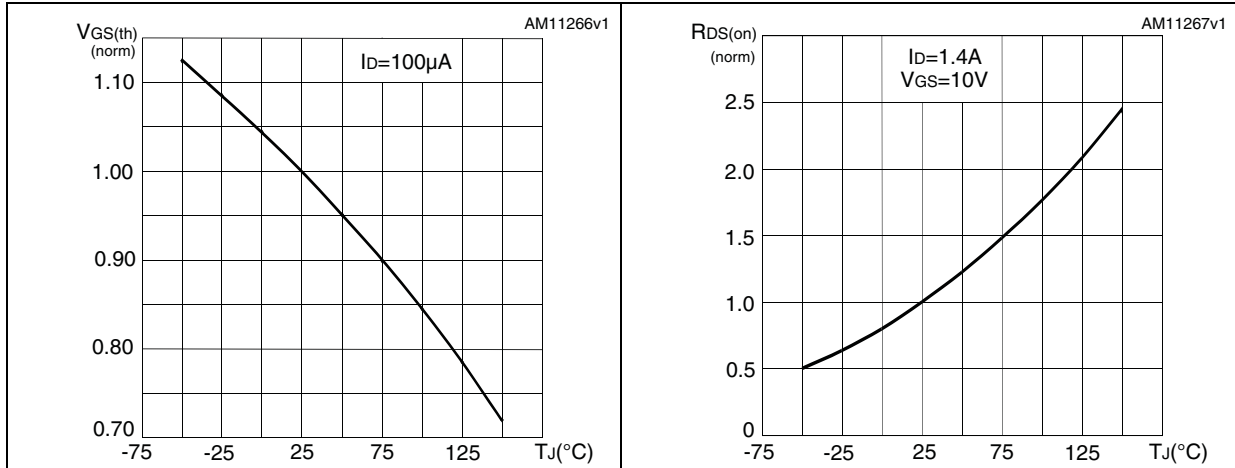
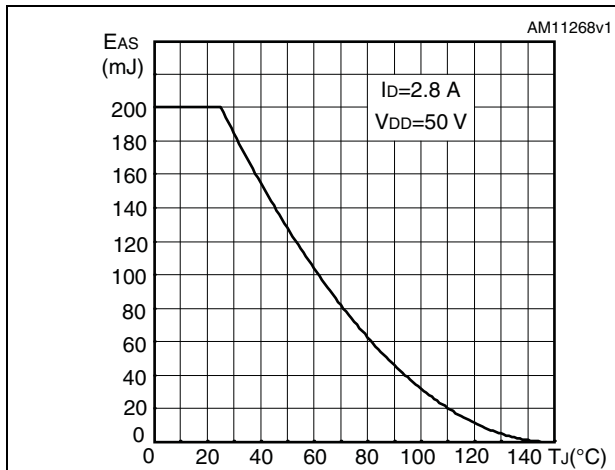

Figure 12. Maximum avalanche energy vs starting T_j



3 Test circuits

Figure 13. Switching times test circuit for resistive load

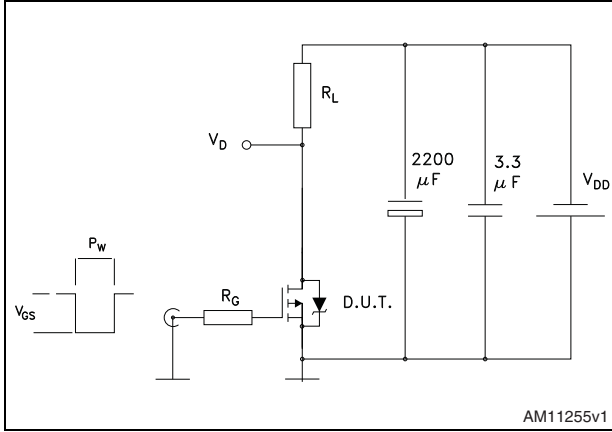

Figure 14. Gate charge test circuit

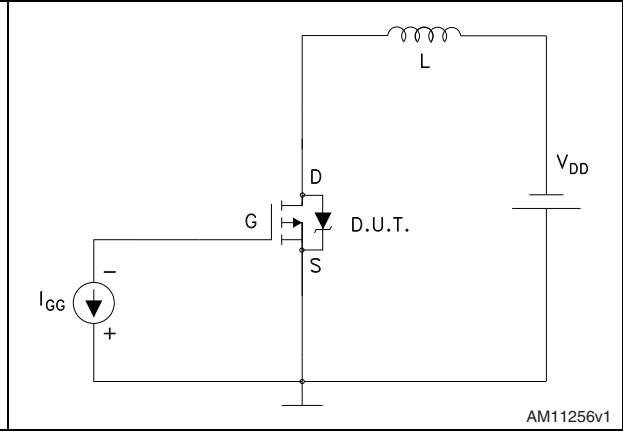
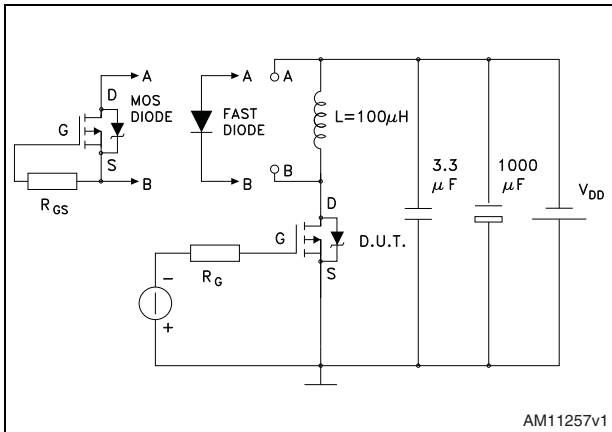

Figure 15. Test circuit for diode recovery behavior



4 Package mechanical data

In order to meet environmental requirements, ST offers these devices in different grades of ECOPACK[®] packages, depending on their level of environmental compliance. ECOPACK[®] specifications, grade definitions and product status are available at: www.st.com. ECOPACK[®] is an ST trademark.

Table 9. DPAK (TO-252) mechanical data

Dim.	mm		
	Min.	Typ.	Max.
A	2.20		2.40
A1	0.90		1.10
A2	0.03		0.23
b	0.64		0.90
b4	5.20		5.40
c	0.45		0.60
c2	0.48		0.60
D	6.00		6.20
D1		5.10	
E	6.40		6.60
E1		4.70	
e		2.28	
e1	4.40		4.60
H	9.35		10.10
L	1		1.50
L1		2.80	
L2		0.80	
L4	0.60		1
R		0.20	
V2	0°		8°

Figure 16. DPAK (TO-252) drawing

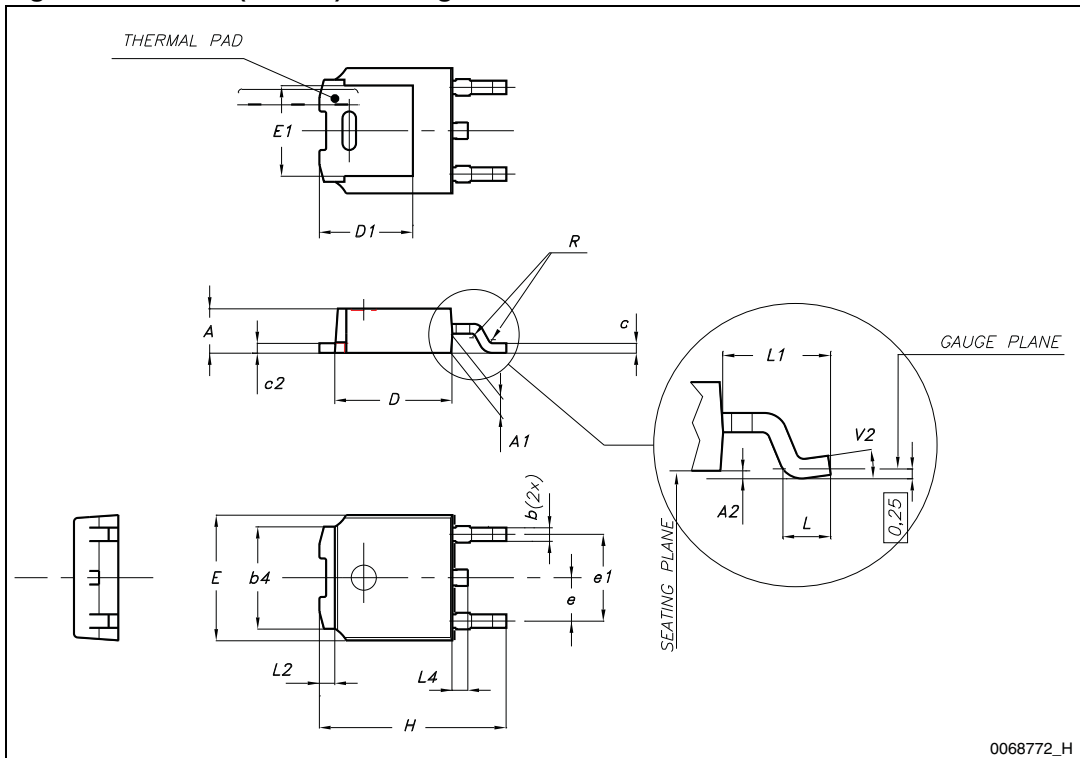
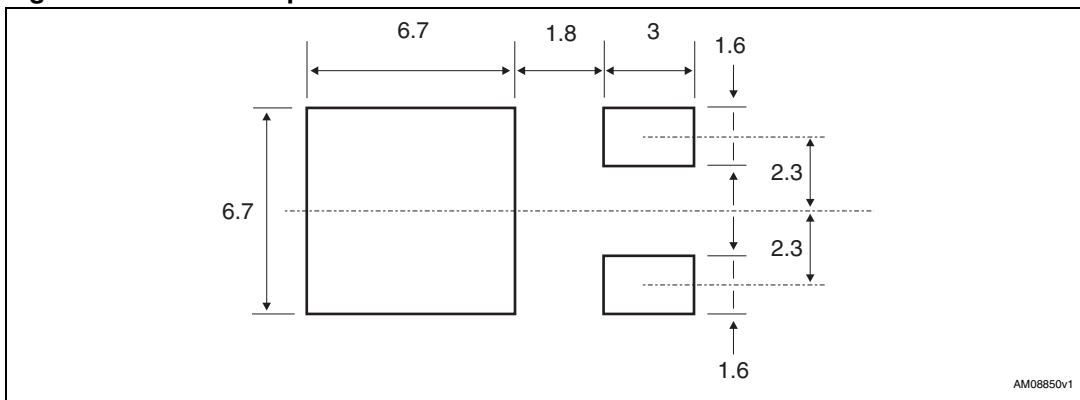

Figure 17. DPAK footprint^(a)



a. All dimensions are in millimeters

5 Packaging mechanical data

Table 10. DPAK (TO-252) tape and reel mechanical data

Tape			Reel		
Dim.	mm		Dim.	mm	
	Min.	Max.		Min.	Max.
A0	6.8	7	A		330
B0	10.4	10.6	B	1.5	
B1		12.1	C	12.8	13.2
D	1.5	1.6	D	20.2	
D1	1.5		G	16.4	18.4
E	1.65	1.85	N	50	
F	7.4	7.6	T		22.4
K0	2.55	2.75			
P0	3.9	4.1	Base qty.		2500
P1	7.9	8.1	Bulk qty.		2500
P2	1.9	2.1			
R	40				
T	0.25	0.35			
W	15.7	16.3			

Figure 18. Tape for DPAK (TO-252)

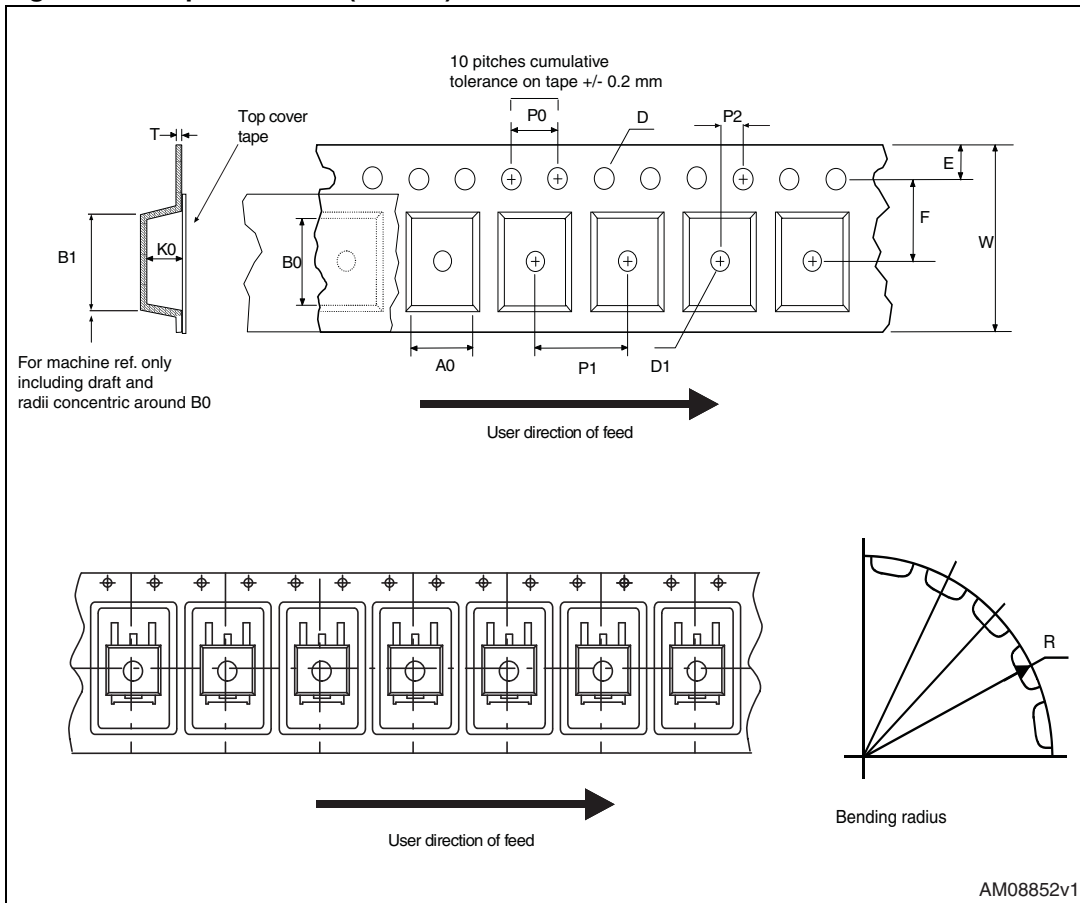
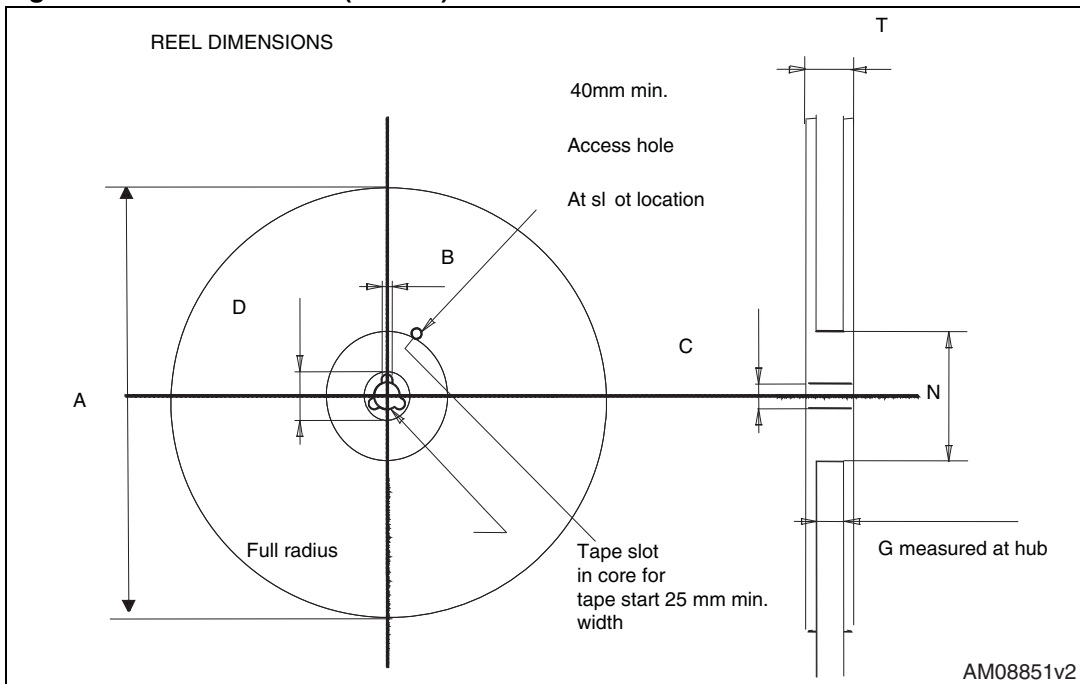

Figure 19. Reel for DPAK (TO-252)



6 Revision history

Table 11. Document revision history

Date	Revision	Changes
26-Nov-2010	1	First release.
31-Aug-2012	2	Document status promoted from preliminary data to production data. Minor text changes on the cover page.

Please Read Carefully:

Information in this document is provided solely in connection with ST products. STMicroelectronics NV and its subsidiaries ("ST") reserve the right to make changes, corrections, modifications or improvements, to this document, and the products and services described herein at any time, without notice.

All ST products are sold pursuant to ST's terms and conditions of sale.

Purchasers are solely responsible for the choice, selection and use of the ST products and services described herein, and ST assumes no liability whatsoever relating to the choice, selection or use of the ST products and services described herein.

No license, express or implied, by estoppel or otherwise, to any intellectual property rights is granted under this document. If any part of this document refers to any third party products or services it shall not be deemed a license grant by ST for the use of such third party products or services, or any intellectual property contained therein or considered as a warranty covering the use in any manner whatsoever of such third party products or services or any intellectual property contained therein.

UNLESS OTHERWISE SET FORTH IN ST'S TERMS AND CONDITIONS OF SALE ST DISCLAIMS ANY EXPRESS OR IMPLIED WARRANTY WITH RESPECT TO THE USE AND/OR SALE OF ST PRODUCTS INCLUDING WITHOUT LIMITATION IMPLIED WARRANTIES OF MERCHANTABILITY, FITNESS FOR A PARTICULAR PURPOSE (AND THEIR EQUIVALENTS UNDER THE LAWS OF ANY JURISDICTION), OR INFRINGEMENT OF ANY PATENT, COPYRIGHT OR OTHER INTELLECTUAL PROPERTY RIGHT.

UNLESS EXPRESSLY APPROVED IN WRITING BY TWO AUTHORIZED ST REPRESENTATIVES, ST PRODUCTS ARE NOT RECOMMENDED, AUTHORIZED OR WARRANTED FOR USE IN MILITARY, AIR CRAFT, SPACE, LIFE SAVING, OR LIFE SUSTAINING APPLICATIONS, NOR IN PRODUCTS OR SYSTEMS WHERE FAILURE OR MALFUNCTION MAY RESULT IN PERSONAL INJURY, DEATH, OR SEVERE PROPERTY OR ENVIRONMENTAL DAMAGE. ST PRODUCTS WHICH ARE NOT SPECIFIED AS "AUTOMOTIVE GRADE" MAY ONLY BE USED IN AUTOMOTIVE APPLICATIONS AT USER'S OWN RISK.

Resale of ST products with provisions different from the statements and/or technical features set forth in this document shall immediately void any warranty granted by ST for the ST product or service described herein and shall not create or extend in any manner whatsoever, any liability of ST.

ST and the ST logo are trademarks or registered trademarks of ST in various countries.

Information in this document supersedes and replaces all information previously supplied.

The ST logo is a registered trademark of STMicroelectronics. All other names are the property of their respective owners.

© 2012 STMicroelectronics - All rights reserved

STMicroelectronics group of companies

Australia - Belgium - Brazil - Canada - China - Czech Republic - Finland - France - Germany - Hong Kong - India - Israel - Italy - Japan - Malaysia - Malta - Morocco - Philippines - Singapore - Spain - Sweden - Switzerland - United Kingdom - United States of America

www.st.com

