

3130/3134/3151

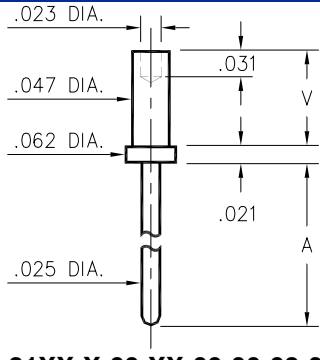

Basic Part Number	Board Thickness	Length A	Length V
3134-1	.031	.079	.051
3134-2	.062	.079	.082
3134-3	.094	.079	.113
3134-4	.125	.079	.145
3130-1	.031	.179	.051
3130-2	.062	.179	.082
3130-3	.094	.179	.113
3130-4	.125	.179	.145
3151-1	.031	.479	.051
3151-2	.062	.479	.082
3151-3	.094	.479	.113
3151-4	.125	.479	.145

31XX-X-00-XX-00-00-08-0
Swage mount in .052 hole

3113

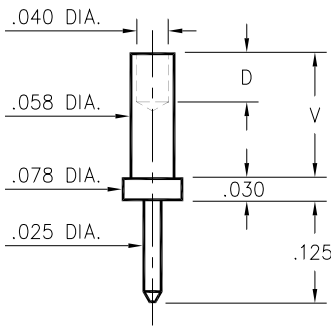

Basic Part Number	Board Thickness	Length V	Depth D
3113-1	.031	.062	.040
3113-2	.062	.094	.062
3113-3	.094	.125	.062
3113-4	.125	.156	.062

3113-X-00-XX-00-00-08-0
Swage mount in .062 hole

3360

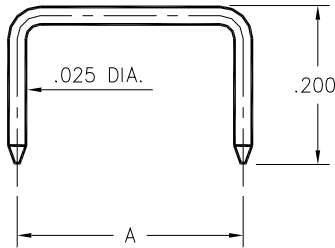

Basic Part Number	Pin Centers A
3360-1	.200
3360-2	.250
3360-3	.300
3360-4	.400
3360-5	.500

3360-X-14-XX-00-00-08-0
Shorting Jumper

3301 ⇒ 3304

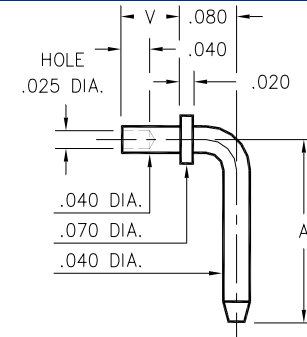

Basic Part Number	Pin Centers A
3301-X	.257
3302-X	.357
3303-X	.375
3304-X	.562

- X -	Board Thickness	Length V
1	.031	.051
2	.062	.082
3	.094	.113

330X-X-14-XX-00-00-08-0
Specify board thickness
Swage mount in .043 hole

3620

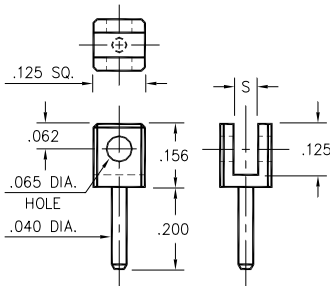

Basic Part Number	Board Thickness	Slot S
3620-1	.031	.047
3620-2	.062	.075

3620-X-32-XX-00-00-08-0
Board edge rivet mount

0940

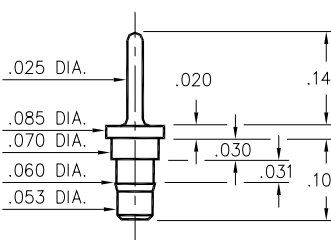

0940-0-00-XX-00-00-03-0
Press-fit in .057 mounting hole

3621

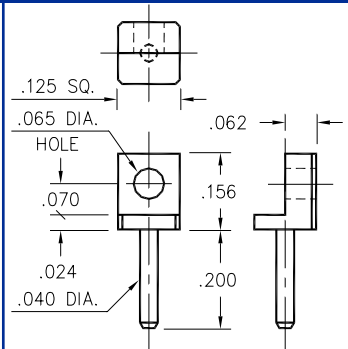

3621-0-32-XX-00-00-08-0
Board edge rivet mount

SPECIFICATIONS

PIN MATERIAL:
Brass Alloy 360, 1/2 Hard
(Except Swage pins which are annealed)

DIMENSION IN INCHES
TOLERANCES ON:
LENGTHS: ±.005
DIAMETERS: ±.002
ANGLES: ± 2°

ORDER CODE: XXXX - X - XX - XX - 00 - 00 - 0X - 0

BASIC PART # →

SPECIFY PIN FINISH:
01 200µ" TIN/LEAD OVER NICKEL
15 10µ" GOLD OVER NICKEL
21 20µ" GOLD OVER NICKEL
34 50µ" GOLD OVER NICKEL