

Overview

KEMET Power Solutions (KPS) Commercial Series stacked capacitors utilize a proprietary lead-frame technology to vertically stack one or two multilayer ceramic chip capacitors into a single compact surface mount package. The attached lead-frame mechanically isolates the capacitor/s from the printed circuit board, therefore offering advanced mechanical and thermal stress performance. Isolation also addresses concerns for audible, microphonic noise that may occur when a bias voltage is applied. A two chip stack offers up to double the capacitance in the same or smaller design footprint when compared to traditional surface mount MLCCs devices. Providing up to 10 mm of board flex capability, KPS Series

capacitors are environmentally friendly and in compliance with RoHS legislation. Available in X7R dielectric, these devices are capable of Pb-Free reflow profiles and provide lower ESR, ESL and higher ripple current capability when compared to other dielectric solutions.

Combined with the stability of an X7R dielectric, KEMET's KPS Series devices exhibit a predictable change in capacitance with respect to time and voltage and boast a minimal change in capacitance with reference to ambient temperature. Capacitance change is limited to $\pm 15\%$ from -55°C to $+125^{\circ}\text{C}$.

Benefits

- -55°C to $+125^{\circ}\text{C}$ operating temperature range
- Reliable and robust termination system
- EIA 1210, 1812, and 2220 case sizes
- DC voltage ratings of 10 V, 16 V, 25 V, 50 V, 100 V, and 250 V
- Capacitance offerings ranging from 0.1 μF up to 47 μF
- Available capacitance tolerances of $\pm 10\%$ and $\pm 20\%$
- Higher capacitance in the same footprint
- Potential board space savings
- Advanced protection against thermal and mechanical stress
- Provides up to 10 mm of board flex capability
- Reduces audible, microphonic noise
- Extremely low ESR and ESL
- Pb-Free and RoHS Compliant
- Capable of Pb-Free reflow profiles
- Non-polar device, minimizing installation concerns
- Tantalum and electrolytic alternative

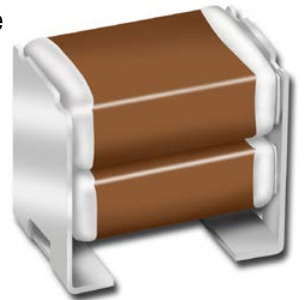

Ordering Information

C	1210	C	225	M	4	R	1	C	7186
Ceramic	Case Size (L" x W")	Specification/ Series	Capacitance Code (pF)	Capacitance Tolerance ¹	Voltage	Dielectric	Failure Rate/Design	Leadframe Finish ²	Packaging/Grade (C-Spec) ³
	1210 1812 2220	C = Standard	2 significant digits + number of zeros	K = $\pm 10\%$ M = $\pm 20\%$	8 = 10 V 4 = 16 V 3 = 25 V 5 = 50 V 1 = 100 V A = 250 V	R = X7R	1 = KPS Single Chip Stack 2 = KPS Double Chip Stack	C = 100% Matte Sn	7186 = 7" Reel Unmarked 7289 = 13" Reel Unmarked

¹ Double chip stacks ("2" in the 13th character position of the ordering code) are only available in M ($\pm 20\%$) capacitance tolerance. Single chip stacks ("1" in the 13th character position of the ordering code) are available in K ($\pm 10\%$) or M ($\pm 20\%$) tolerances.

² Additional leadframe finish options may be available. Contact KEMET for details.

³ Additional reeling or packaging options may be available. Contact KEMET for details.

Dimensions – Millimeters (Inches)

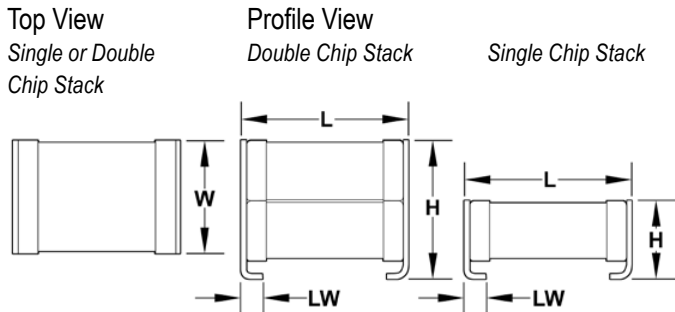

Number of Chips	EIA Size Code	Metric Size Code	L Length	W Width	H Height	LW Lead Width	Mounting Technique
Single	1210	3225	3.50 (.138) ±0.30 (.012)	2.60 (.102) ±0.30 (.012)	3.35 (.132) ±0.10 (.004)	0.80 (.032) ±0.15 (.006)	Solder Reflow Only
	1812	4532	5.00 (.197) ±0.50 (.020)	3.50 (.138) ±0.50 (.020)	2.65 (.104) ±0.35 (.014)	1.10 (.043) ±0.30 (.012)	
	2220	5650	6.00 (.236) ±0.50 (.020)	5.00 (.197) ±0.50 (.020)	3.50 (.138) ±0.30 (.012)	1.60 (.063) ±0.30 (.012)	
Double	1210	3225	3.50 (.138) ±0.30 (.012)	2.60 (.102) ±0.30 (.012)	6.15 (.242) ±0.15 (.006)	0.80 (.031) ±0.15 (.006)	
	1812	4532	5.00 (.197) ±0.50 (.020)	3.50 (.138) ±0.50 (.020)	5.00 (.197) ±0.50 (.020)	1.10 (.043) ±0.30 (.012)	
	2220	5650	6.00 (.236) ±0.50 (.020)	5.00 (.197) ±0.50 (.020)	5.00 (.197) ±0.50 (.020)	1.60 (.063) ±0.30 (.012)	

Applications

Typical applications include smoothing circuits, DC/DC converters, power supplies (input/output filters), noise reduction (piezoelectric/mechanical), circuits with a direct battery or power source connection, critical and safety relevant circuits without (integrated) current limitation and any application that is subject to high levels of board flexure or temperature cycling. Markets include industrial, military, automotive and telecom.

Qualification/Certification

Commercial Grade products are subject to internal qualification. Details regarding test methods and conditions are referenced in Table 4, Performance & Reliability.

Environmental Compliance

Pb-Free and RoHS Compliant.



RoHS Compliant

Electrical Parameters/Characteristics

Item	Parameters/Characteristics
Operating Temperature Range	-55°C to +125°C
Capacitance Change with Reference to +25°C and 0 VDC Applied (TCC)	±15%
Aging Rate (Maximum % Capacitance Loss/Decade Hour)	3.0%
Dielectric Withstanding Voltage (DWV)	250% of rated voltage (5 ±1 seconds and charge/discharge not exceeding 50 mA)
Dissipation Factor (DF) Maximum Limit @ 25°C	5%(10 V), 3.5%(16 V and 25 V) and 2.5%(50 V to 250 V)
Insulation Resistance (IR) Limit @ 25°C	See Insulation Resistance Limit Table (Rated voltage applied for 120 ±5 seconds @ 25°C)

Regarding aging rate: Capacitance measurements (including tolerance) are indexed to a referee time of 48 or 1,000 hours. Please refer to a part number specific datasheet for referee time details.

To obtain IR limit, divide $M\Omega \cdot \mu F$ value by the capacitance and compare to $G\Omega$ limit. Select the lower of the two limits.

Capacitance and dissipation factor (DF) measured under the following conditions:

1 kHz ±50 Hz and 1.0 ±0.2 Vrms if capacitance ≤ 10 μF

120 Hz ±10 Hz and 0.5 ±0.1 Vrms if capacitance > 10 μF

Note: When measuring capacitance it is important to ensure the set voltage level is held constant. The HP4284 and Agilent E4980 have a feature known as Automatic Level Control (ALC). The ALC feature should be switched to "ON."

Post Environmental Limits

High Temperature Life, Biased Humidity, Moisture Resistance					
Dielectric	Rated DC Voltage	Capacitance Value	Dissipation Factor (Maximum %)	Capacitance Shift	Insulation Resistance
X7R	> 25	All	3.0	±20%	10% of Initial Limit
	16/25		5.0		
	< 16		7.5		

Insulation Resistance Limit Table

EIA Case Size	1,000 Megohm Microfarads or 100 GΩ	500 Megohm Microfarads or 10 GΩ
1210	< 0.39 μF	≥ 0.39 μF
1812	< 2.2 μF	≥ 2.2 μF
2220	< 10 μF	≥ 10 μF

Electrical Characteristics

Z and ESR C1210C475M5R1C

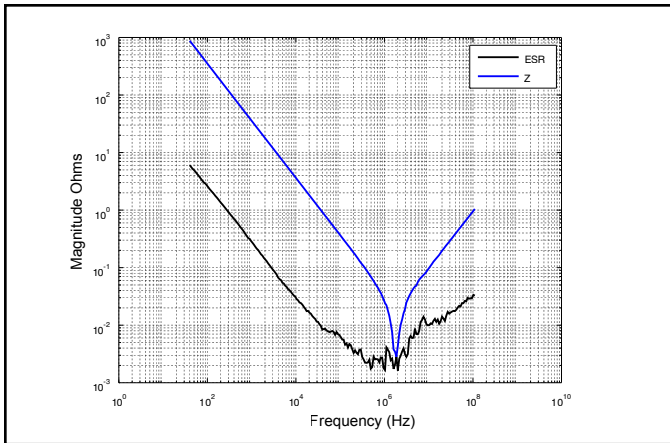

Z and ESR C2220C225MAR2C

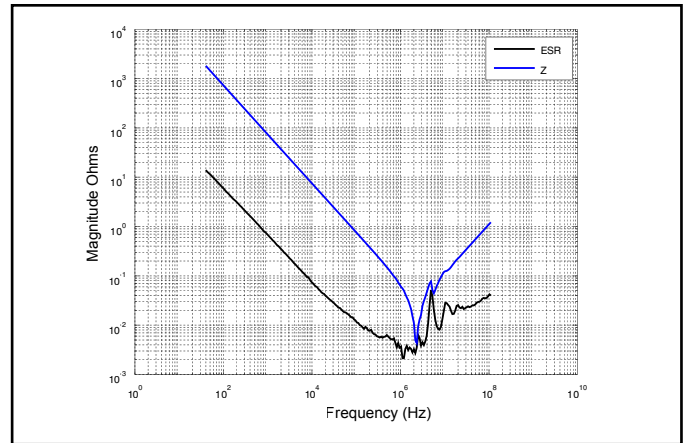

Z and ESR C2220C476M3R2C

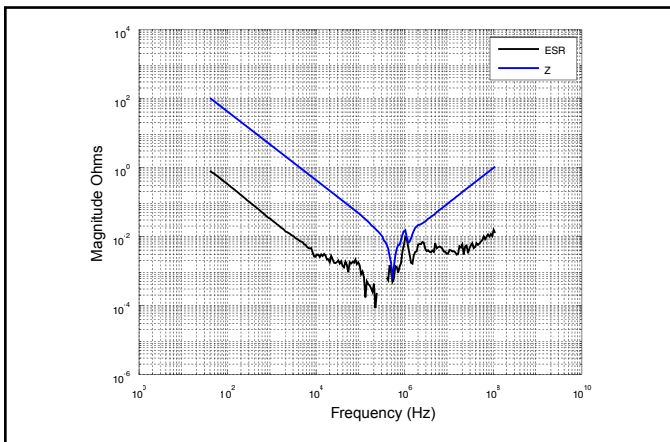

Electrical Characteristics cont'd

ESR – 1812, .10 μ F, 50 V X7R

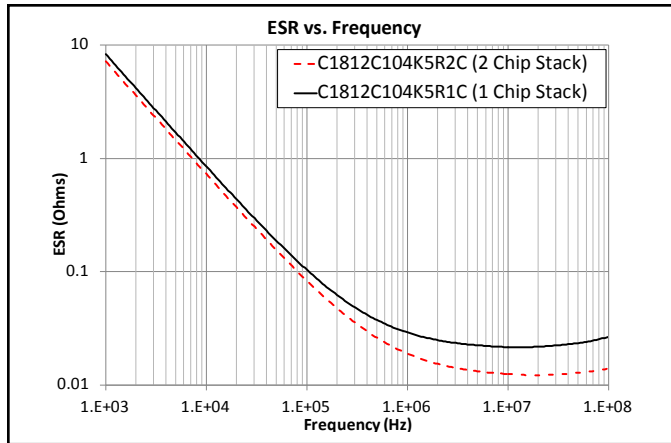

Impedance – 1812, .10 μ F, 50 V X7R

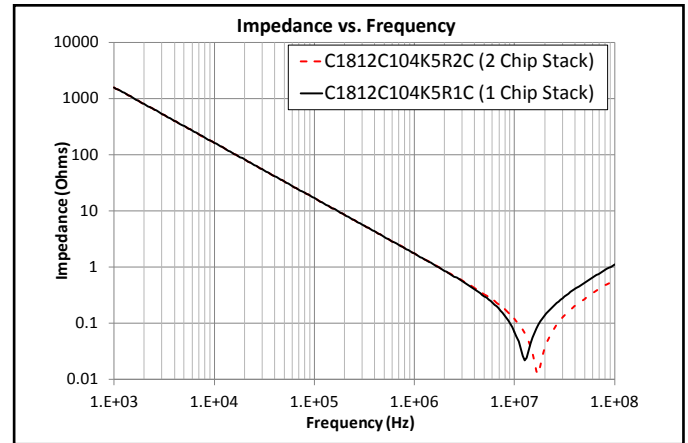

ESR – 1210, .22 μ F, 50 V X7R

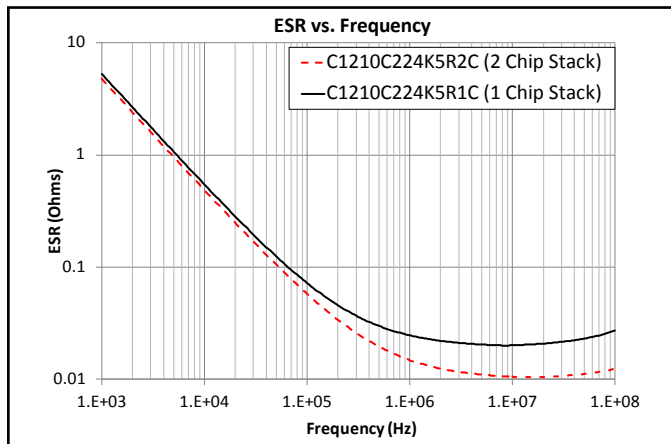

Impedance – 1210, .22 μ F, 50 V X7R

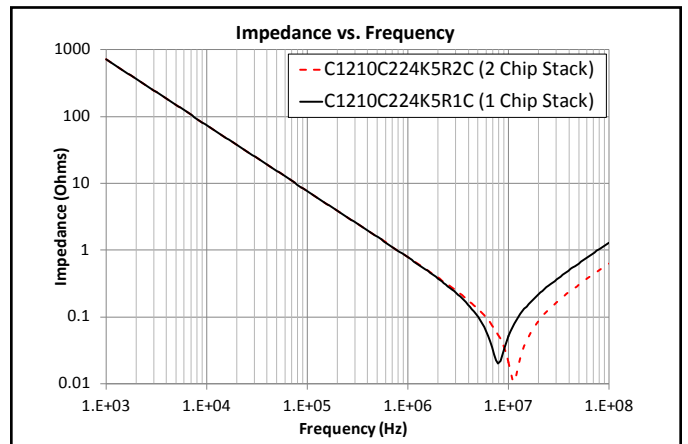

Electrical Characteristics cont'd

Microphonics – 1210, 4.7 μ F, 50 V, X7R

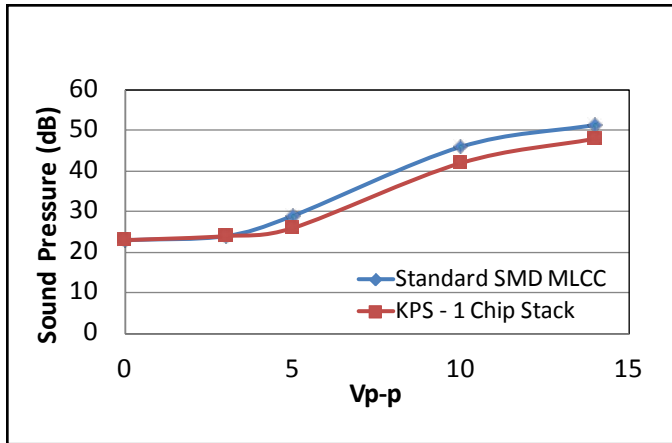

Microphonics – 2220, 22 μ F, 50 V, X7R

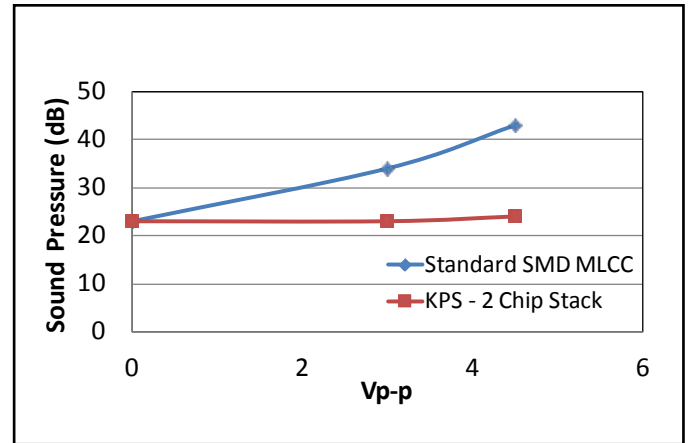

Microphonics – 2220, 47 μ F, 25 V, X7R

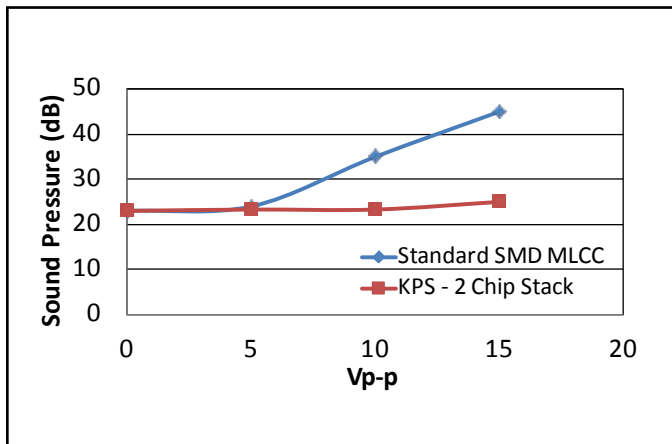

Microphonics – 1210, 22 μ F, 25 V, X7R

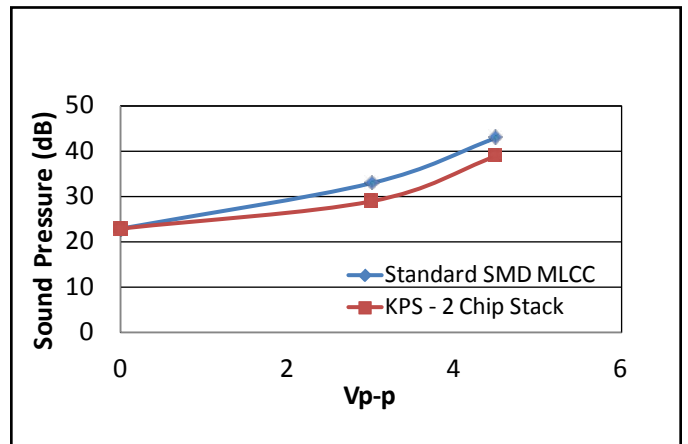

Competitive Comparison

Microphonics – 1210, 4.7 μ F, 50 V, X7R

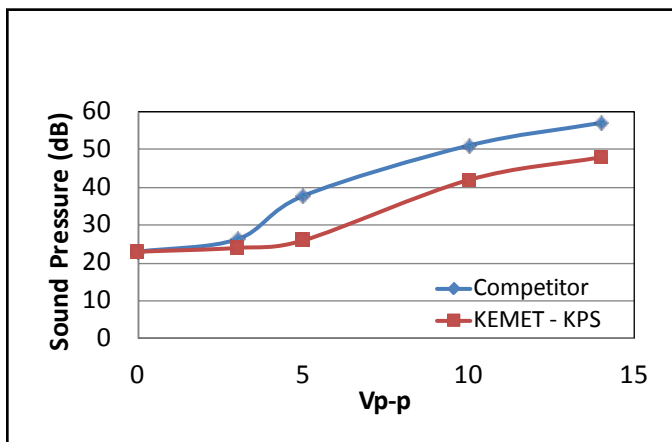

Ripple Current (Arms) 2220, 22 μ F, 50 V

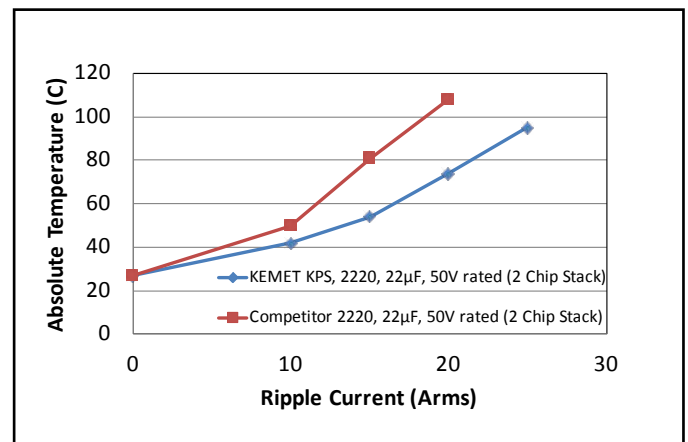

Note: Refer to Table 4 for test method.

Electrical Characteristics cont'd

Board Flex vs. Termination Type

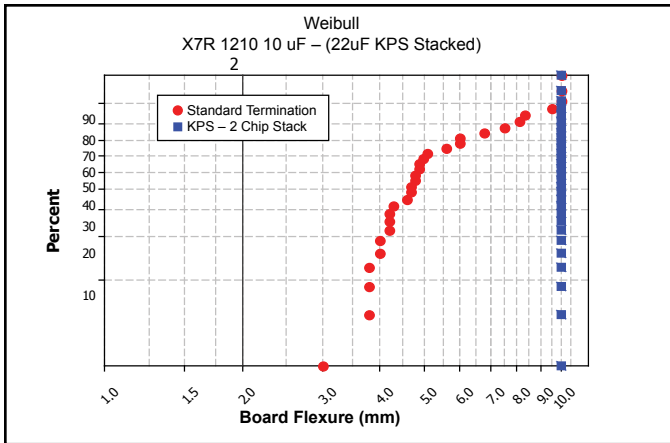

Board Flex vs. Termination Type

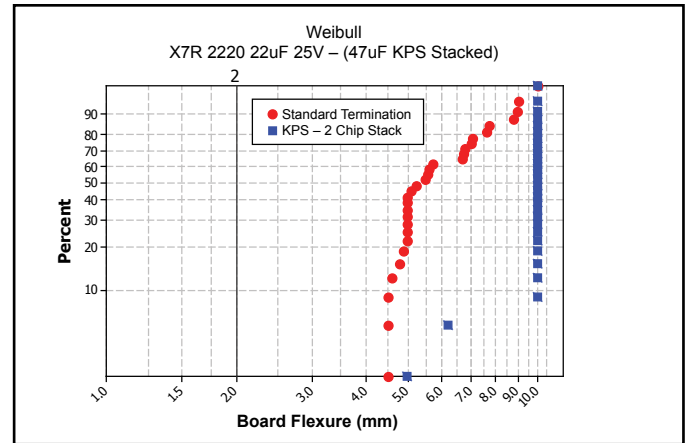

Board Flexure to 10 mm

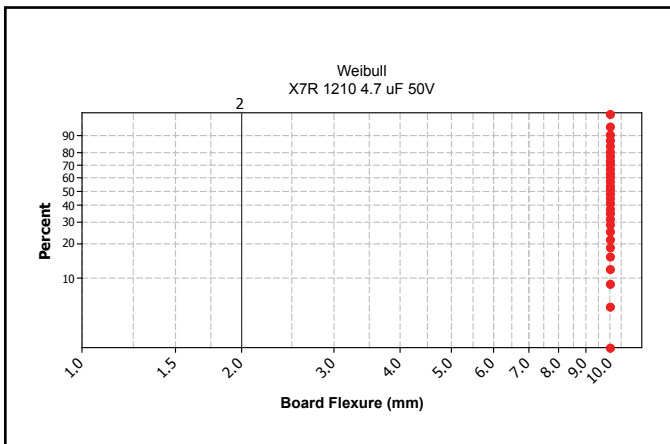

Board Flexure to 10 mm

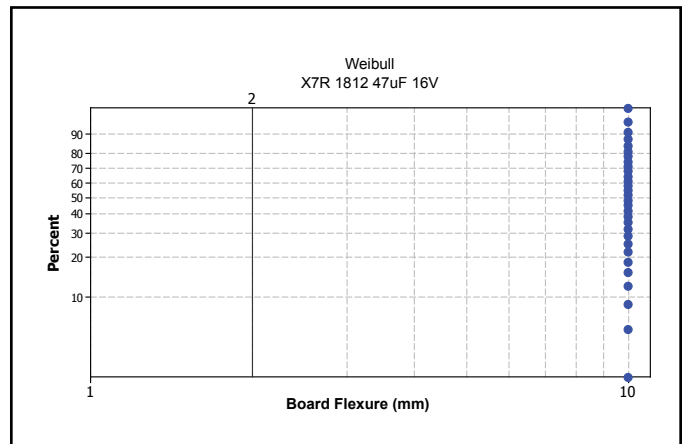

Table 1 – Capacitance Range/Selection Waterfall (1210 – 2220 Case Sizes)

Capacitance	Cap Code	Series		C1210						C1812					C2220				
		Voltage Code		8	4	3	5	1	A	4	3	5	1	A	4	3	5	1	A
		Voltage DC		10	16	25	50	100	250	16	25	50	100	250	16	25	50	100	250
		Capacitance Tolerance		Product Availability and Chip Thickness Codes See Table 2 for Chip Thickness Dimensions															
Single Chip Stack																			
0.10 µF	104	K	M	FV	FV	FV	FV	FV	FV	GP	GP	GP	GP	GP	JP	JP	JP	JP	JP
0.22 µF	224	K	M	FV	FV	FV	FV	FV	FV	GP	GP	GP	GP	GP	JP	JP	JP	JP	JP
0.47 µF	474	K	M	FV	FV	FV	FV	FV	FV	GP	GP	GP	GP	GP	JP	JP	JP	JP	JP
1.0 µF	105	K	M	FV	FV	FV	FV	FV	FV	GP	GP	GP	GP	GP	JP	JP	JP	JP	JP
2.2 µF	225	K	M	FV	FV	FV	FV	FV	FV	GP	GP	GP	GP	GP	JP	JP	JP	JP	JP
3.3 µF	335	K	M	FV	FV	FV	FV	FV	FV	GP	GP	GP	GP	GP	JP	JP	JP	JP	JP
4.7 µF	475	K	M	FV	FV	FV	FV	FV	FV	GP	GP	GP	GP	GP	JP	JP	JP	JP	JP
10 µF	106	K	M	FV	FV	FV	FV	FV	FV	GP	GP	GP	GP	GP	JP	JP	JP	JP	JP
15 µF	156	K	M	FV	FV	FV	FV	FV	FV	GP	GP	GP	GP	GP	JP	JP	JP	JP	JP
22 µF	226	K	M	FV	FV	FV	FV	FV	FV	GP	GP	GP	GP	GP	JP	JP	JP	JP	JP
33 µF	336	K	M	FV	FV	FV	FV	FV	FV	GP	GP	GP	GP	GP	JP	JP	JP	JP	JP
47 µF	476	K	M	FV	FV	FV	FV	FV	FV	GP	GP	GP	GP	GP	JP	JP	JP	JP	JP
100 µF	107	K	M	FV	FV	FV	FV	FV	FV	GP	GP	GP	GP	GP	JP	JP	JP	JP	JP
Double Chip Stack																			
0.10 µF	104		M	FW	FW	FW	FW	FW	FW	GR	GR	GR	GR	GR	JR	JR	JR	JR	JR
0.22 µF	224		M	FW	FW	FW	FW	FW	FW	GR	GR	GR	GR	GR	JR	JR	JR	JR	JR
0.47 µF	474		M	FW	FW	FW	FW	FW	FW	GR	GR	GR	GR	GR	JR	JR	JR	JR	JR
1.0 µF	105		M	FW	FW	FW	FW	FW	FW	GR	GR	GR	GR	GR	JR	JR	JR	JR	JR
2.2 µF	225		M	FW	FW	FW	FW	FW	FW	GR	GR	GR	GR	GR	JR	JR	JR	JR	JR
3.3 µF	335		M	FW	FW	FW	FW	FW	FW	GR	GR	GR	GR	GR	JR	JR	JR	JR	JR
4.7 µF	475		M	FW	FW	FW	FW	FW	FW	GR	GR	GR	GR	GR	JR	JR	JR	JR	JR
10 µF	106		M	FW	FW	FW	FW	FW	FW	GR	GR	GR	GR	GR	JR	JR	JR	JR	JR
22 µF	226		M	FW	FW	FW	FW	FW	FW	GR	GR	GR	GR	GR	JR	JR	JR	JR	JR
33 µF	336		M	FW	FW	FW	FW	FW	FW	GR	GR	GR	GR	GR	JR	JR	JR	JR	JR
47 µF	476		M	FW	FW	FW	FW	FW	FW	GR	GR	GR	GR	GR	JR	JR	JR	JR	JR
100 µF	107		M	FW	FW	FW	FW	FW	FW	GR	GR	GR	GR	GR	JR	JR	JR	JR	JR
220 µF	227		M	FW	FW	FW	FW	FW	FW	GR	GR	GR	GR	GR	JR	JR	JR	JR	JR
Capacitance	Cap Code	Voltage DC		10	16	25	50	100	250	16	25	50	100	250	16	25	50	100	250
		Voltage Code		8	4	3	5	1	A	4	3	5	1	A	4	3	5	1	A
		Series		C1210						C1812					C2220				

These products are protected under US Patent 8,331,078 other patents pending, and any foreign counterparts.

Table 2 – Chip Thickness/Packaging Quantities

Thickness Code	Case Size	Thickness ± Range (mm)	Paper Quantity		Plastic Quantity	
			7" Reel	13" Reel	7" Reel	13" Reel
FV	1210	3.35 ± 0.10	0	0	600	2,000
FW	1210	6.15 ± 0.15	0	0	300	1,000
GP	1812	2.65 ± 0.35	0	0	500	2,000
GR	1812	5.00 ± 0.50	0	0	400	1,700
JP	2220	3.50 ± 0.30	0	0	300	1,300
JR	2220	5.00 ± 0.50	0	0	200	800
Thickness Code	Case Size	Thickness ± Range (mm)	7" Reel	13" Reel	7" Reel	13" Reel
			Paper Quantity		Plastic Quantity	

Package quantity based on finished chip thickness specifications.

Table 3 – KPS Land Pattern Design Recommendations (mm)

EIA SIZE CODE	METRIC SIZE CODE	Median (Nominal) Land Protrusion				
		C	Y	X	V1	V2
1210	3225	1.50	1.14	1.75	5.05	3.40
1812	4532	2.20	1.35	2.87	6.70	4.50
2220	5650	2.69	2.08	4.78	7.70	6.00

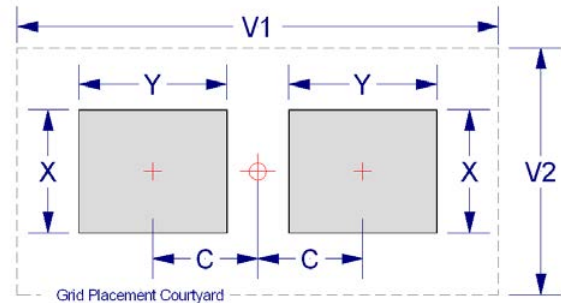

Soldering Process

KEMET's KPS Series devices are compatible with IR reflow techniques. Preheating of these components is recommended to avoid extreme thermal stress. KEMET's recommended profile conditions for IR reflow reflect the profile conditions of the IPC/J-STD-020D standard for moisture sensitivity testing.

To prevent degradation of temperature cycling capability, care must be taken to prevent solder from flowing into the inner side of the lead frames (inner side of "J" lead in contact with the circuit board).

After soldering, the capacitors should be air cooled to room temperature before further processing. Forced air cooling is not recommended.

Hand soldering should be performed with care due to the difficulty in process control. If performed, care should be taken to avoid contact of the soldering iron to the capacitor body. The iron should be used to heat the solder pad, applying solder between the pad and the lead, until reflow occurs. Once reflow occurs, the iron should be removed immediately. (Preheating is required when hand soldering to avoid thermal shock.)

Profile Feature	SnPb Assembly	Pb-Free Assembly
Preheat/Soak		
Temperature Minimum (T_{smin})	100°C	150°C
Temperature Maximum (T_{smax})	150°C	200°C
Time (t_s) from T_{smin} to T_{smax}	60 – 120 seconds	60 – 120 seconds
Ramp-up Rate (T_L to T_p)	3°C/seconds maximum	3°C/seconds maximum
Liquidous Temperature (T_L)	183°C	217°C
Time Above Liquidous (t_L)	60 – 150 seconds	60 – 150 seconds
Peak Temperature (T_p)	235°C	250°C
Time within 5°C of Maximum Peak Temperature (t_p)	20 seconds maximum	10 seconds maximum
Ramp-down Rate (T_p to T_L)	6°C/seconds maximum	6°C/seconds maximum
Time 25°C to Peak Temperature	6 minutes maximum	8 minutes maximum

Note: All temperatures refer to the center of the package, measured on the package body surface that is facing up during assembly reflow.

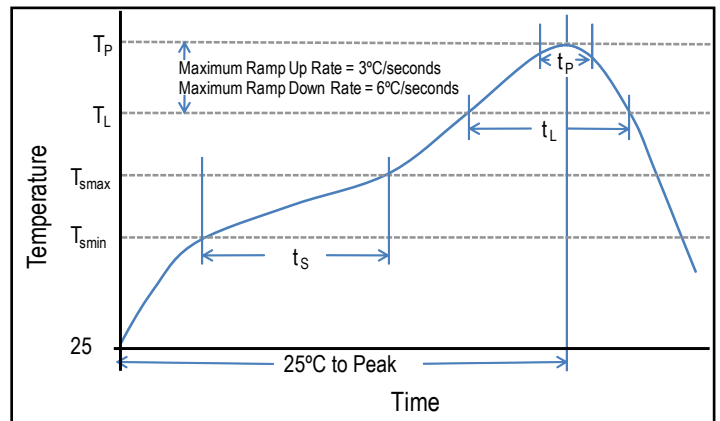

Table 4 – Performance & Reliability: Test Methods and Conditions

Stress	Reference	Test or Inspection Method
Terminal Strength	JIS-C-6429	Appendix 1, Note: Force of 1.8 kg for 60 seconds.
Board Flex	JIS-C-6429	Appendix 2, Note: 5.0 mm minimum
Solderability	J-STD-002	Magnification 50 X. Conditions:
		a) Method B, 4 hours @ 155°C, dry heat @ 235°C
		b) Method B @ 215°C category 3
		c) Method D, category 3 @ 250°C
Temperature Cycling	JESD22 Method JA-104	1,000 cycles (-55°C to +125°C). Measurement at 24 hours +/- 2 hours after test conclusion.
Biased Humidity	MIL-STD-202 Method 103	Load Humidity: 1,000 hours 85°C/85% RH and 200 VDC maximum. Add 100 K ohm resistor. Measurement at 24 hours +/- 2 hours after test conclusion.
		Low Volt Humidity: 1,000 hours 85°C/85% RH and 1.5 V. Add 100 K ohm resistor. Measurement at 24 hours +/- 2 hours after test conclusion.
Moisture Resistance	MIL-STD-202 Method 106	t = 24 hours/cycle. Steps 7a and 7b not required. Unpowered. Measurement at 24 hours +/- 2 hours after test conclusion.
Thermal Shock	MIL-STD-202 Method 107	-55°C/+125°C. Note: Number of cycles required – 300. Maximum transfer time – 20 seconds. Dwell time – 15 minutes. Air-Air.
High Temperature Life	MIL-STD-202 Method 108	1,000 hours at 125°C with rated voltage applied.
Storage Life	MIL-STD-202 Method 108	150°C, 0 VDC for 1,000 hours.
Vibration	MIL-STD-202 Method 204	5 g's for 20 minutes, 12 cycles each of 3 orientations. Note: Use 8" X 5" PCB .031" thick, 7 secure points on one long side and 2 secure points at corners of opposite sides. Parts mounted within 2" from any secure point. Test from 10 – 2,000 Hz.
Mechanical Shock	MIL-STD-202 Method 213	Figure 1 of Method 213, Condition F.
Resistance to Solvents	MIL-STD-202 Method 215	Add aqueous wash chemical, OKEM Clean or equivalent.

Storage & Handling

Ceramic chip capacitors should be stored in normal working environments. While the chips themselves are quite robust in other environments, solderability will be degraded by exposure to high temperatures, high humidity, corrosive atmospheres, and long term storage. In addition, packaging materials will be degraded by high temperature– reels may soften or warp and tape peel force may increase. KEMET recommends that maximum storage temperature not exceed 40°C and maximum storage humidity not exceed 70% relative humidity. Temperature fluctuations should be minimized to avoid condensation on the parts and atmospheres should be free of chlorine and sulfur bearing compounds. For optimized solderability chip stock should be used promptly, preferably within 1.5 years of receipt.

Construction

Reference	Item	Material
A	Leadframe	Phosphor Bronze – Alloy 510
B	Leadframe Attach	HMP Solder
C	Termination	Cu
D		Ni
E		Sn
F	Inner Electrode	Ni
G	Dielectric Material	BaTiO ₃

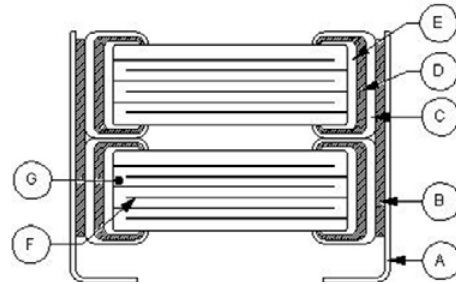

Note: Image is exaggerated in order to clearly identify all components of construction.
 HMP = High Melting Point

Product Marking

Laser marking option is not available on:

- COG, Ultra Stable X8R and Y5V dielectric devices
- EIA 0402 case size devices
- EIA 0603 case size devices with Flexible Termination option.
- KPS Commercial and Automotive grade stacked devices.

These capacitors are supplied unmarked only.

Tape & Reel Packaging Information

KEMET offers multilayer ceramic chip capacitors packaged in 8, 12 and 16 mm tape on 7" and 13" reels in accordance with EIA Standard 481. This packaging system is compatible with all tape-fed automatic pick and place systems. See Table 2 for details on reeling quantities for commercial chips.

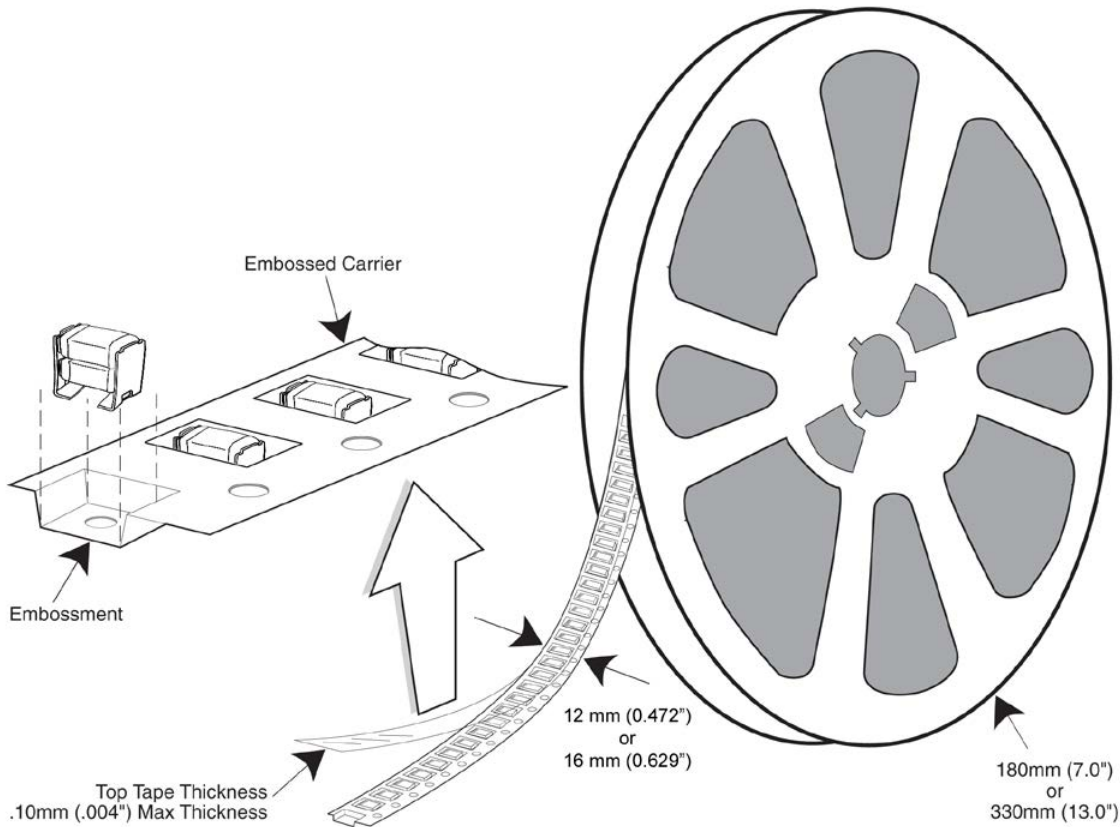

Table 5 – Carrier Tape Configuration – Embossed Plastic (mm)

EIA Case Size	Tape Size (W)*	Pitch (P ₁)*
01005 – 0402	8	2
0603 – 1210	8	4
1805 – 1808	12	4
≥ 1812	12	8
KPS 1210	12	8
KPS 1812 & 2220	16	12
Array 0508 & 0612	8	4

*Refer to Figure 1 for W and P₁ carrier tape reference locations.

*Refer to Table 5 for tolerance specifications.

Figure 1 – Embossed (Plastic) Carrier Tape Dimensions

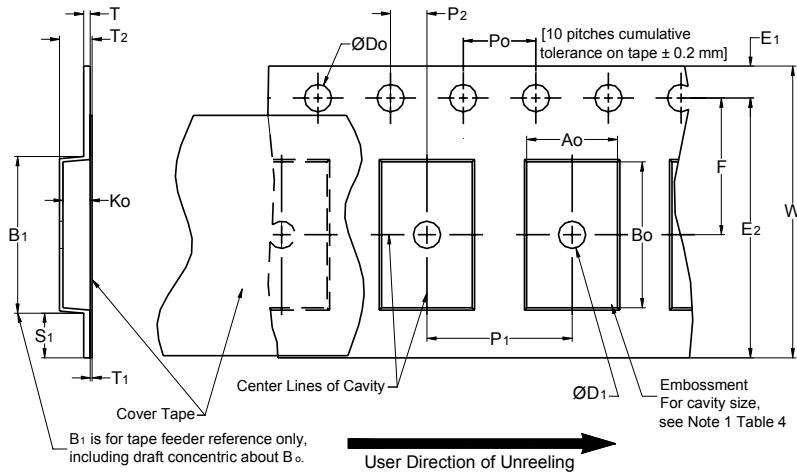

Table 6 – Embossed (Plastic) Carrier Tape Dimensions

Metric will govern

Constant Dimensions — Millimeters (Inches)									
Tape Size	D_0	D_1 Minimum Note 1	E_1	P_0	P_2	R Reference Note 2	S_1 Minimum Note 3	T Maximum	T_1 Maximum
8 mm	$1.5 +0.10/-0.0$ ($0.059 +0.004/-0.0$)	1.0 (0.039)	1.75 ± 0.10 (0.069 ± 0.004)	4.0 ± 0.10 (0.157 ± 0.004)	2.0 ± 0.05 (0.079 ± 0.002)	25.0 (0.984)	0.600 (0.024)	0.600 (0.024)	0.100 (0.004)
12 mm		1.5 (0.059)				30 (1.181)			
16 mm									
Variable Dimensions — Millimeters (Inches)									
Tape Size	Pitch	B_1 Maximum Note 4	E_2 Minimum	F	P_1	T_2 Maximum	W Maximum	A_0, B_0 & K_0	
8 mm	Single (4 mm)	4.35 (0.171)	6.25 (0.246)	3.5 ± 0.05 (0.138 ± 0.002)	4.0 ± 0.10 (0.157 ± 0.004)	2.5 (0.098)	8.3 (0.327)	Note 5	
12 mm	Single (4 mm) & Double (8 mm)	8.2 (0.323)	10.25 (0.404)	5.5 ± 0.05 (0.217 ± 0.002)	8.0 ± 0.10 (0.315 ± 0.004)	4.6 (0.181)	12.3 (0.484)		
16 mm	Triple (12 mm)	12.1 (0.476)	14.25 (0.561)	7.5 ± 0.05 (0.138 ± 0.002)	12.0 ± 0.10 (0.157 ± 0.004)	4.6 (0.181)	16.3 (0.642)		

- The embossment hole location shall be measured from the sprocket hole controlling the location of the embossment. Dimensions of embossment location and hole location shall be applied independent of each other.
- The tape with or without components shall pass around R without damage (see Figure 5).
- If $S_1 < 1.0$ mm, there may not be enough area for cover tape to be properly applied (see EIA Standard 481 paragraph 4.3 section b).
- B_1 dimension is a reference dimension for tape feeder clearance only.
- The cavity defined by A_0 , B_0 and K_0 shall surround the component with sufficient clearance that:
 - the component does not protrude above the top surface of the carrier tape.
 - the component can be removed from the cavity in a vertical direction without mechanical restriction, after the top cover tape has been removed.
 - rotation of the component is limited to 20° maximum for 8 and 12 mm tapes and 10° maximum for 16 mm tapes (see Figure 2).
 - lateral movement of the component is restricted to 0.5 mm maximum for 8 and 12 mm wide tape and to 1.0 mm maximum for 16 mm tape (see Figure 3).
 - for KPS Series product, A_0 and B_0 are measured on a plane 0.3 mm above the bottom of the pocket.
 - see Addendum in EIA Standard 481 for standards relating to more precise taping requirements.

Packaging Information Performance Notes

- 1. Cover Tape Break Force:** 1.0 Kg minimum.
- 2. Cover Tape Peel Strength:** The total peel strength of the cover tape from the carrier tape shall be:

Tape Width	Peel Strength
8 mm	0.1 to 1.0 Newton (10 to 100 gf)
12 and 16 mm	0.1 to 1.3 Newton (10 to 130 gf)

The direction of the pull shall be opposite the direction of the carrier tape travel. The pull angle of the carrier tape shall be 165° to 180° from the plane of the carrier tape. During peeling, the carrier and/or cover tape shall be pulled at a velocity of 300 ±10 mm/minute.

- 3. Labeling:** Bar code labeling (standard or custom) shall be on the side of the reel opposite the sprocket holes. Refer to EIA Standards 556 and 624.

Figure 2 – Maximum Component Rotation

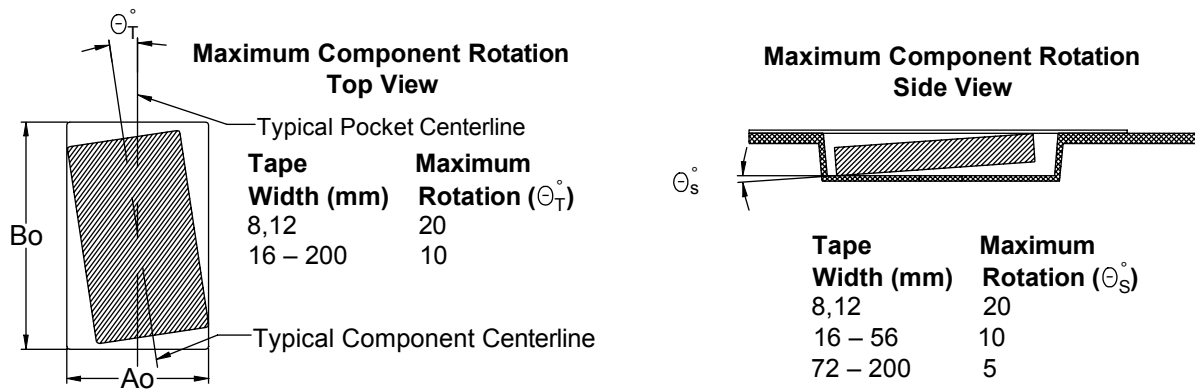

Figure 3 – Maximum Lateral Movement

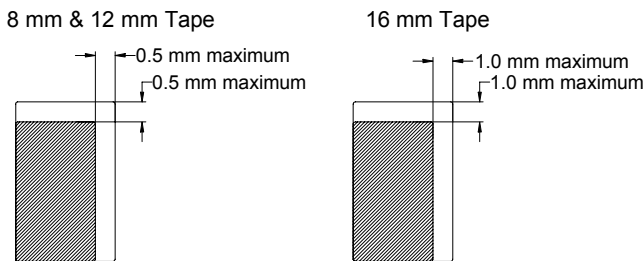

Figure 4 – Bending Radius

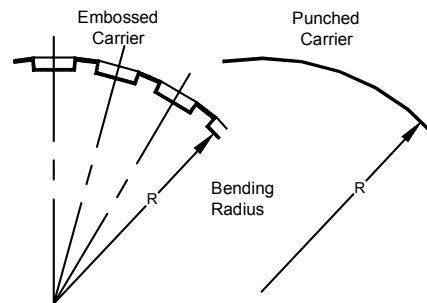
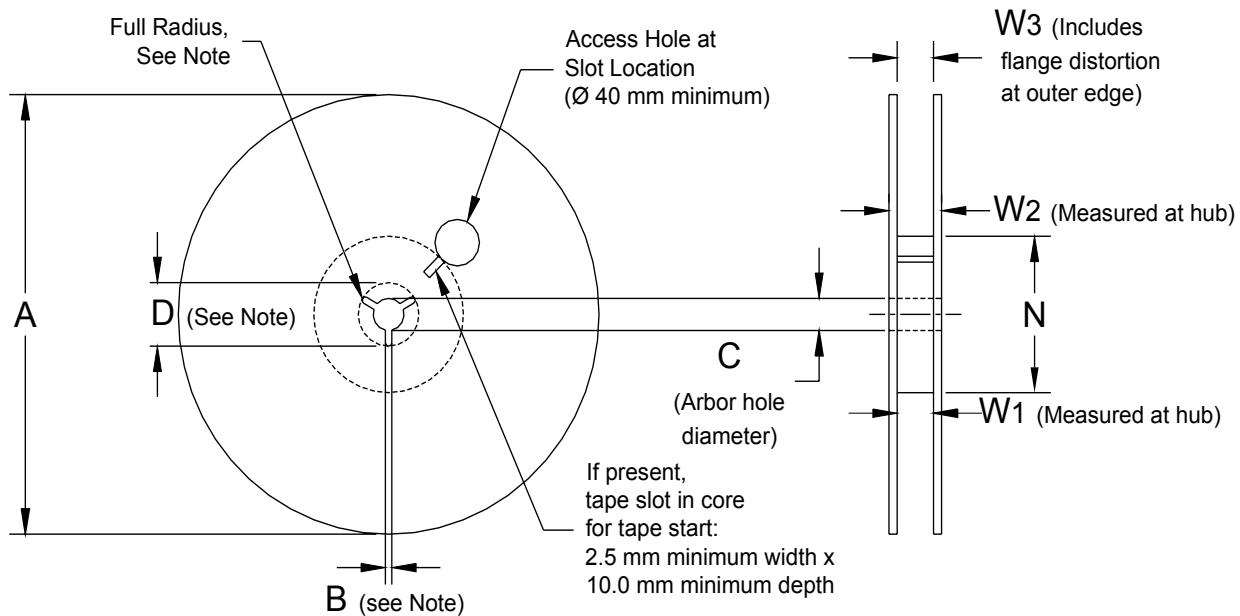

Figure 5 – Reel Dimensions



Note: Drive spokes optional; if used, dimensions B and D shall apply.

Table 7 – Reel Dimensions

Metric will govern

Constant Dimensions — Millimeters (Inches)				
Tape Size	A	B Minimum	C	D Minimum
8 mm	178 ±0.20 (7.008 ±0.008) or 330 ±0.20 (13.000 ±0.008)	1.5 (0.059)	13.0 +0.5/-0.2 (0.521 +0.02/-0.008)	20.2 (0.795)
12 mm				
16 mm				
Variable Dimensions — Millimeters (Inches)				
Tape Size	N Minimum	W ₁	W ₂ Maximum	W ₃
8 mm	50 (1.969)	8.4 +1.5/-0.0 (0.331 +0.059/-0.0)	14.4 (0.567)	Shall accommodate tape width without interference
12 mm		12.4 +2.0/-0.0 (0.488 +0.078/-0.0)	18.4 (0.724)	
16 mm		16.4 +2.0/-0.0 (0.646 +0.078/-0.0)	22.4 (0.882)	

Figure 6 – Tape Leader & Trailer Dimensions

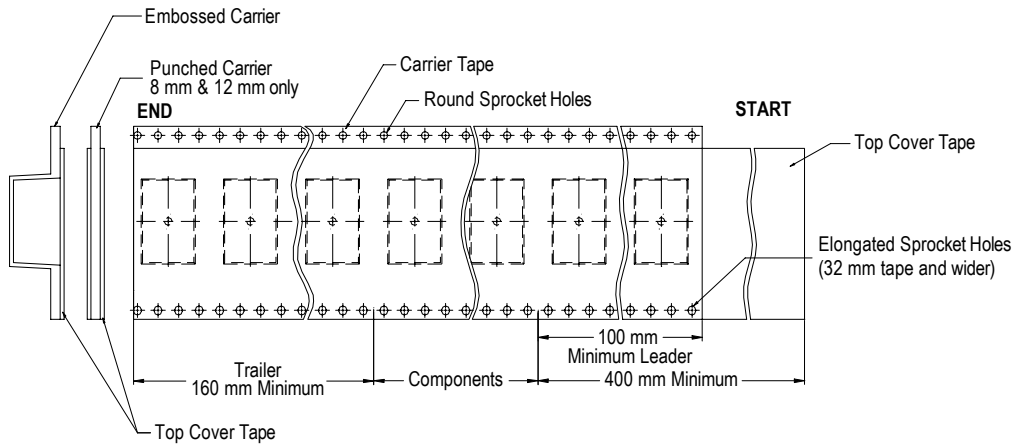
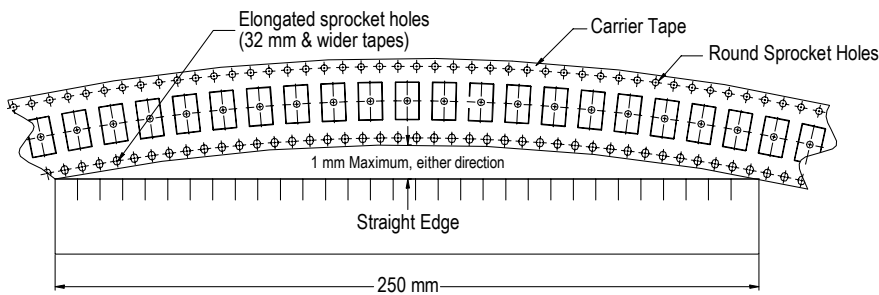

Figure 7 – Maximum Camber



KEMET Corporation World Headquarters

2835 KEMET Way
Simpsonville, SC 29681

Mailing Address:
P.O. Box 5928
Greenville, SC 29606

www.kemet.com
Tel: 864-963-6300
Fax: 864-963-6521

Corporate Offices
Fort Lauderdale, FL
Tel: 954-766-2800

North America

Southeast
Lake Mary, FL
Tel: 407-855-8886

Northeast
Wilmington, MA
Tel: 978-658-1663

Central
Novi, MI
Tel: 248-994-1030

West
Milpitas, CA
Tel: 408-433-9950

Mexico
Guadalajara, Jalisco
Tel: 52-33-3123-2141

Europe

Southern Europe
Paris, France
Tel: 33-1-4646-1006

Sasso Marconi, Italy
Tel: 39-051-939111

Central Europe
Landsberg, Germany
Tel: 49-8191-3350800

Kamen, Germany
Tel: 49-2307-438110

Northern Europe
Bishop's Stortford, United Kingdom
Tel: 44-1279-460122

Espoo, Finland
Tel: 358-9-5406-5000

Asia

Northeast Asia
Hong Kong
Tel: 852-2305-1168

Shenzhen, China
Tel: 86-755-2518-1306

Beijing, China
Tel: 86-10-5829-1711

Shanghai, China
Tel: 86-21-6447-0707

Taipei, Taiwan
Tel: 886-2-27528585

Southeast Asia
Singapore
Tel: 65-6586-1900

Penang, Malaysia
Tel: 60-4-6430200

Bangalore, India
Tel: 91-806-53-76817

Note: KEMET reserves the right to modify minor details of internal and external construction at any time in the interest of product improvement. KEMET does not assume any responsibility for infringement that might result from the use of KEMET Capacitors in potential circuit designs. KEMET is a registered trademark of KEMET Electronics Corporation.

Other KEMET Resources

Tools	
Resource	Location
Configure A Part: CapEdge	http://capacitoredge.kemet.com
SPICE & FIT Software	http://www.kemet.com/spice
Search Our FAQs: KnowledgeEdge	http://www.kemet.com/keask
Electrolytic LifeCalculator	http://www.kemet.com:8080/elc

Product Information	
Resource	Location
Products	http://www.kemet.com/products
Technical Resources (Including Soldering Techniques)	http://www.kemet.com/technicalpapers
RoHS Statement	http://www.kemet.com/rohs
Quality Documents	http://www.kemet.com/qualitydocuments

Product Request	
Resource	Location
Sample Request	http://www.kemet.com/sample
Engineering Kit Request	http://www.kemet.com/kits

Contact	
Resource	Location
Website	www.kemet.com
Contact Us	http://www.kemet.com/contact
Investor Relations	http://www.kemet.com/ir
Call Us	1-877-MyKEMET
Twitter	http://twitter.com/kemetcapacitors

Disclaimer

All product specifications, statements, information and data (collectively, the "Information") in this datasheet are subject to change. The customer is responsible for checking and verifying the extent to which the Information contained in this publication is applicable to an order at the time the order is placed.

All Information given herein is believed to be accurate and reliable, but it is presented without guarantee, warranty, or responsibility of any kind, expressed or implied.

Statements of suitability for certain applications are based on KEMET Electronics Corporation's ("KEMET") knowledge of typical operating conditions for such applications, but are not intended to constitute – and KEMET specifically disclaims – any warranty concerning suitability for a specific customer application or use. The Information is intended for use only by customers who have the requisite experience and capability to determine the correct products for their application. Any technical advice inferred from this Information or otherwise provided by KEMET with reference to the use of KEMET's products is given gratis, and KEMET assumes no obligation or liability for the advice given or results obtained.

Although KEMET designs and manufactures its products to the most stringent quality and safety standards, given the current state of the art, isolated component failures may still occur. Accordingly, customer applications which require a high degree of reliability or safety should employ suitable designs or other safeguards (such as installation of protective circuitry or redundancies) in order to ensure that the failure of an electrical component does not result in a risk of personal injury or property damage.

Although all product-related warnings, cautions and notes must be observed, the customer should not assume that all safety measures are indicated or that other measures may not be required.

Mouser Electronics

Authorized Distributor

Click to View Pricing, Inventory, Delivery & Lifecycle Information:

Kemet:

[C2220C225MAR2CTU](#) [C1210C225K1R1CT500](#) [C2220C335K5R1CT500](#) [C1210C105K1R1CT500](#)
[C2220C105MAR2CT500](#) [C1812C226M4R2CT500](#) [C1812C106M3R2CT500](#) [C1812C335M5R2CT500](#)
[C1812C474MAR2CT500](#) [C2220C476M3R2CT500](#) [C2220C336M4R2CT500](#) [C2220C106K3R1CT500](#)
[C2220C106K5R1CT500](#) [C2220C106M5R2CT500](#) [C2220C225MAR2CT500](#) [C2220C225M1R2CT500](#)
[C2220C335K1R1CT500](#) [C1210C225K1R1CAUTO](#) [C1210C476M8R2CT500](#) [C1210C475M1R2CT500](#)
[C2220C226M5R2CT500](#) [C1210C475K5R1CT500](#) [C1210C106M5R2CTU](#) [C1210C105K1R1CAUTO](#)
[C1210C476M8R2CAUTO](#) [C1812C106M3R2CAUTO](#) [C1812C226M4R2CAUTO](#) [C1812C335M5R2CAUTO](#)
[C1812C474MAR2CAUTO](#) [C2220C105MAR2CAUTO](#) [C2220C106K5R1CAUTO](#) [C2220C106M5R2CAUTO](#)
[C2220C225M1R2CAUTO](#) [C2220C225MAR2CAUTO](#) [C2220C226M5R2CAUTO](#) [C2220C335K5R1CAUTO](#)
[C2220C476M3R2CAUTO](#) [C1812C105MAR2CT500](#)