

METAL SHELL RIGHT ANGLE FEMALE RECEPTACLES

.087" (SHORT) TAIL LENGTH



PHYSICAL PROPERTIES

INSULATION MATERIAL: Glass filled thermoplastic rated UL 94V-0
COLOR: Black
CONTACTS: High strength copper alloy
METAL SHELL: Steel, bright tin plate
DURABILITY: Up to 500 insertions and withdrawals without degradation of performance, dependent upon contact plating thickness selected

ELECTRICAL PROPERTIES

OPERATING VOLTAGE: 600 VDC (sea level)
CURRENT RATING: 5 Amperes
CONTACT RESISTANCE: 10 milliohms max. @ rated current
INSULATION RESISTANCE: 5000 megohms minimum
DIELECTRIC WITHSTANDING VOLTAGE: 1000 VAC minimum

ENVIRONMENTAL PROPERTIES

TEMPERATURE RATING: -55°C TO 125°C

MOUNTING HARDWARE

Passivated stainless steel

PART NUMBER: 187500110202

Included In Assembly: (2) #4 Flat Washers
 (1) #4 Lock Washers
 (1) #4-40 Nut

Connector Sold Separately

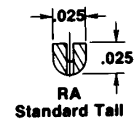
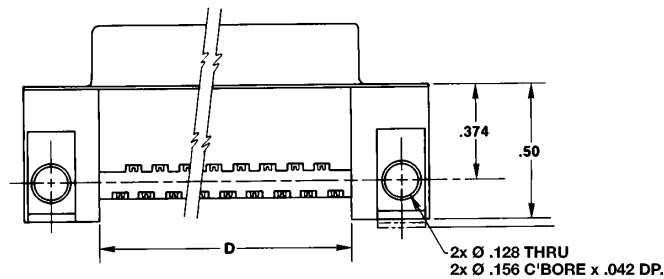
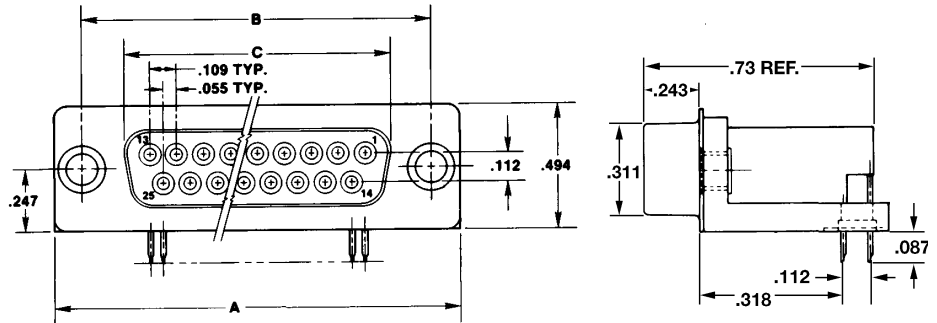

TAIL SECTION (X-X)

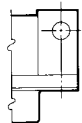

MOUNTING STYLE A
FLUSH

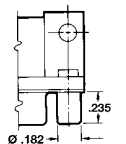

MOUNTING STYLE B
THREADED STANDOFF

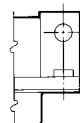

MOUNTING STYLE C
FLUSH INSERT

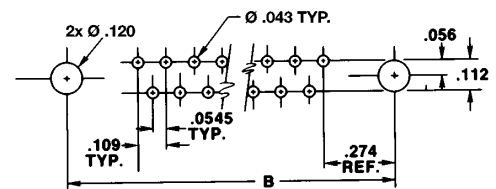
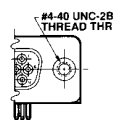
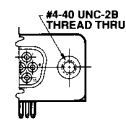
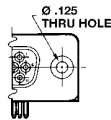

PC BOARD HOLE PATTERN

Ordering Information

NUMBER OF CONTACTS	BASIC CONNECTOR W/THRU HOLES	CATALOG NUMBER BY MOUNTING STYLE		DIMENSIONS			
		ROUND STANDOFF 4-40 THREAD	FLUSH INSERT 4-40 THREAD	A	B	C	D
9	H5R09RA29A*M87	H5R09RA29B*M87	H5R09RA29C*M87	1.224	.984	.646	.624
15	H5R15RA29A*M87	H5R15RA29B*M87	H5R15RA29C*M87	1.552	1.312	.974	.952
25	H5R25RA29A*M87	H5R25RA29B*M87	H5R25RA29C*M87	2.092	1.852	1.514	1.492
37	H5R37RA29A*M87	H5R37RA29B*M87	H5R37RA29C*M87	2.740	2.500	2.162	2.140

*Insert S for metal PC board snap latches and P for plastic PC board latches.