

# ASMT-Mx00

## Moonstone™ 1 W Power LED Light Source



### Data Sheet



#### Description

The Moonstone™ 1W Power LED Light Source is a high performance energy efficient device which can handle high thermal and high driving current. The exposed pad design has excellent heat transfer from the package to the motherboard.

The Cool White Power LED is available in various color temperature ranging from 4000K to 10000K and Warm White Power LED ranging from 2600K to 4000K.

The low profile package design is suitable for a wide variety of applications especially where height is a constraint.

The package is compatible with reflow soldering process. This will give more freedom and flexibility to the light source designer.

#### Applications

- Portable (flash light, bicycle head light)
- Reading light
- Architectural lighting
- Garden lighting
- Decorative lighting

#### Features

- Available in Red, Amber, Green, Blue, Cool White and Warm White color
- Energy efficient
- Exposed pad for excellent heat transfer
- Suitable for reflow soldering process
- High current operation
- Long operation life
- Wide viewing angle
- Silicone encapsulation
- ESD Class HBM Class 3B (threshold > 8 kV)
- MSL 2A for InGaN products
- MSL 4 for AllInGaP products

#### Specifications

- AllInGaP technology for Red and Amber
- 2.1V (typ) at 350mA for AllInGaP
- InGaN technology for Green, Blue, Cool White and Warm White
- 3.2V (typ) at 350mA for InGaN

## Package Dimensions

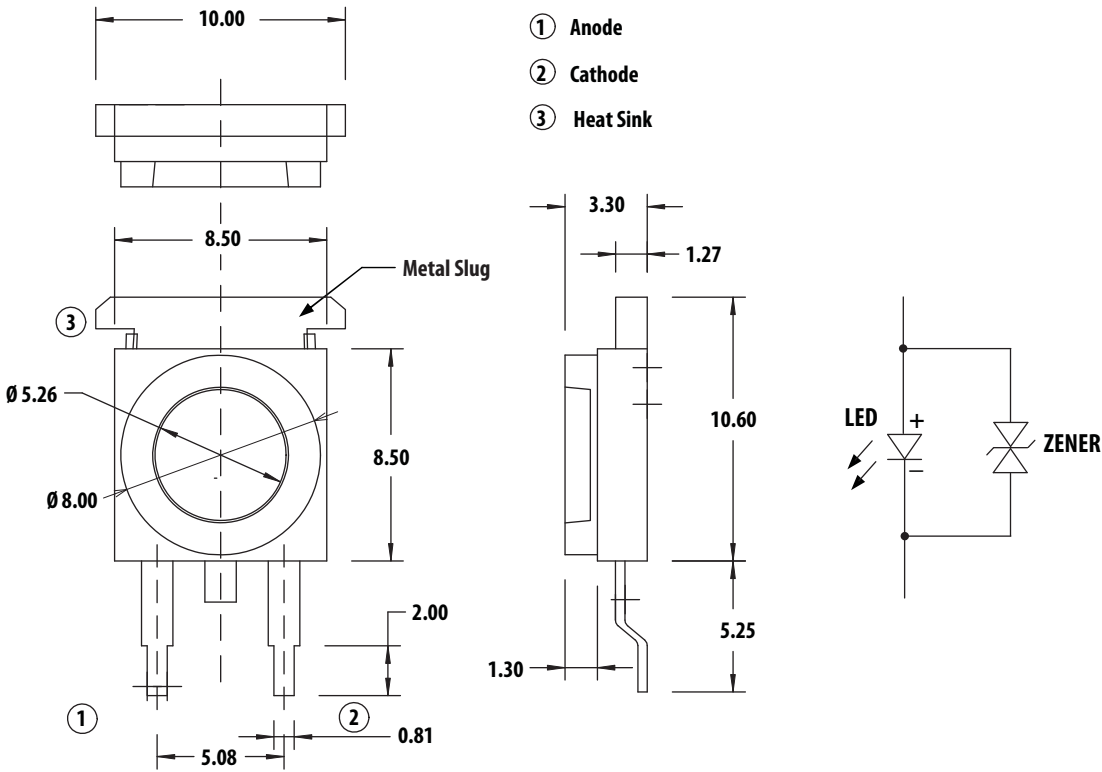

### Notes:

1. All dimensions are in millimeters.
2. Tolerance is  $\pm 0.1$  mm unless otherwise specified.
3. Metal slug is connected to anode for electrically non-isolated option.

## Device Selection Guide ( $T_j = 25^\circ\text{C}$ )

Part Number	Color	Luminous Flux, $\phi_v^{[1,2]}$ (lm)			Test Current (mA)	Dice Technology
		Min.	Typ.	Max.		
ASMT-MR00-AGH00	Red	25.5	35.0	43.0	350	AllInGaP
ASMT-MR00-AHJ00		33.0	40.0	56.0	350	AllInGaP
ASMT-MA00-AGH00	Amber	25.5	35.0	43.0	350	AllInGaP
ASMT-MG00	Green	43.0	60.0	73.0	350	InGaN
ASMT-MB00	Blue	11.5	15.0	25.5	350	InGaN
ASMT-MW00	Cool White	43.0	60.0	73.0	350	InGaN
ASMT-MY00	Warm White	43.0	50.0	73.0	350	InGaN
ASMT-MWB1	Cool White Diffused	43.0	55.0	73.0	350	InGaN
ASMT-MYB1	Warm White Diffused	43.0	46.0	73.0	350	InGaN

### Notes

1.  $\phi_v$  is the total luminous flux output as measured with an integrating sphere at 25 ms mono pulse condition.
2. Flux tolerance is  $\pm 10\%$ .

## Part Numbering System

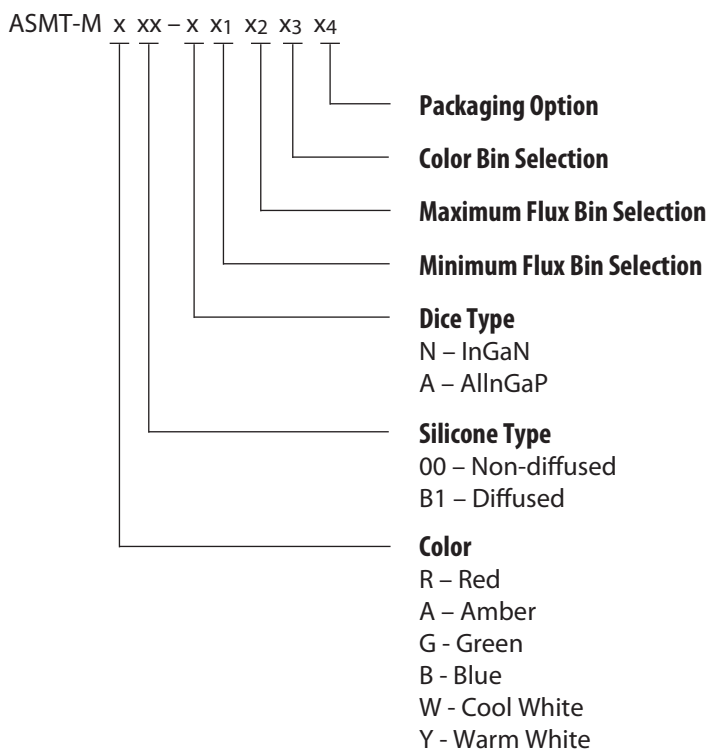

Note:

1. Please refer to Page 8 for selection details.

### Absolute Maximum Ratings ( $T_A = 25^\circ\text{C}$ )

Parameter	ASMT-Mx00/ ASMT-MxB1	Units
DC Forward Current <sup>[1]</sup>	350	mA
Peak Pulsing Current <sup>[2]</sup>	1000	mA
Power Dissipation for AllnGaP	805	mW
Power Dissipation for InGaN	1225	mW
LED Junction Temperature for AllnGaP	125	°C
LED Junction Temperature for InGaN	110	°C
Operating Ambient Temperature Range	-40 to +100	°C
Storage Temperature Range	-40 to +120	°C
Reverse Voltage <sup>[3]</sup>	Not recommended	

Notes:

1. DC forward current – derate linearly based on Figure 5 for AllnGaP & Figure 11 for InGaN.
2. Pulse condition duty factor = 10%, Frequency = 1kHz.
3. Not recommended for reverse bias operation.

### Optical Characteristics at 350 mA (T<sub>J</sub> = 25°C)

Part Number	Color	Peak Wavelength, $\lambda_{PEAK}$ (nm)	Dominant Wave- length, $\lambda_D$ <sup>[1]</sup> (nm)	Viewing Angle, 2 $\theta$ <sup>1/2</sup> [2] (°)	Luminous Efficiency (lm/W)
		Typ	Typ	Typ	Typ
ASMT-MR00-AGH00	Red	635	625	120	48
ASMT-MR00-AHJ00	Red	635	625	120	54
ASMT-MA00-AGH00	Amber	598	590	120	48
ASMT-MG00	Green	519	525	120	54
ASMT-MB00	Blue	454	460	120	13

Part Number	Color	Correlated Color Temperature, CCT (Kelvin)		Viewing Angle, 2 $\theta$ <sup>1/2</sup> [2] (°)	Luminous Efficiency (lm/W)
		Min.	Max.	Typ	Typ
ASMT-MW00	Cool White	4000	10000	110	54
ASMT-MY00	Warm White	2600	4000	110	45
ASMT-MWB1	Cool White Diffused	4000	10000	110	49
ASMT-MYB1	Warm White Diffused	2600	4000	110	41

### Electrical Characteristic at 350 mA (T<sub>J</sub> = 25°C)

Dice type	Forward Voltage V <sub>F</sub> (Volts) at I <sub>F</sub> = 350mA			Thermal Resistance R $\theta$ j-ms (°C/W) <sup>[1]</sup>
	Min.	Typ.	Max.	Typ.
AllnGaP	1.7	2.1	2.3	12
InGaN	2.8	3.2	3.5	10

Notes:

1. R $\theta$  j-ms is Thermal Resistance from LED junction to metal slug.

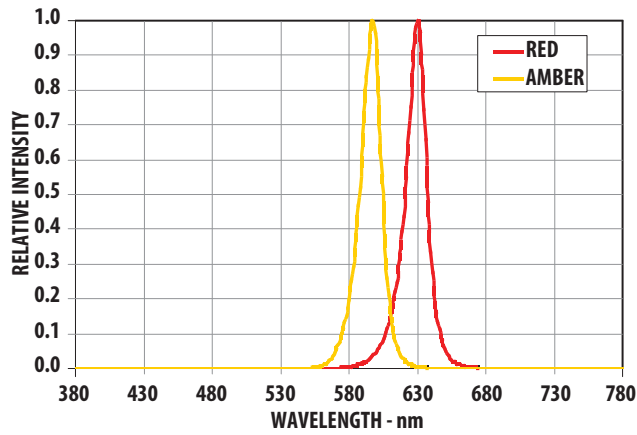

Figure 1. Relative Intensity vs. Wavelength for AllnGaP

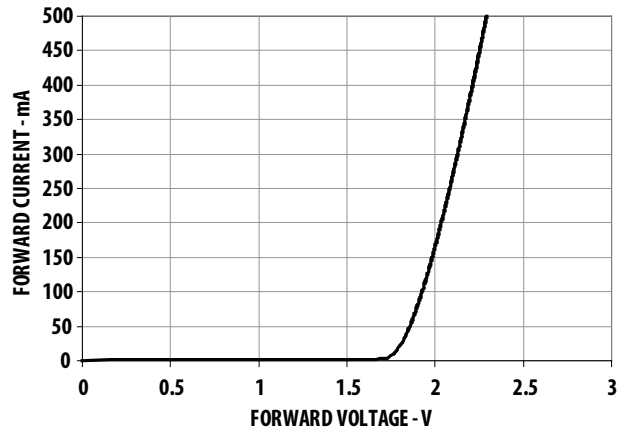

Figure 2. Forward Current vs Forward Voltage for AllnGaP

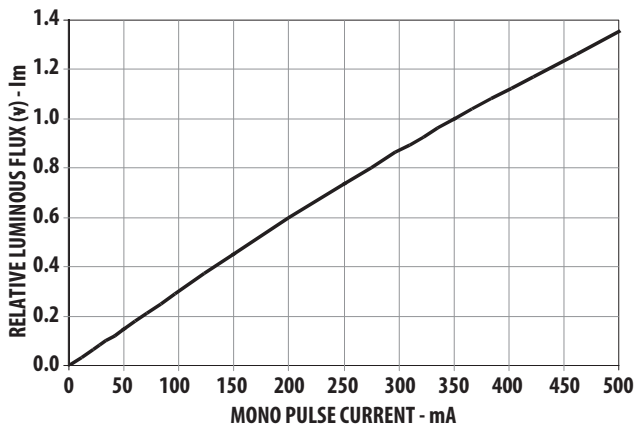

Figure 3. Relative Luminous Flux vs. Mono Pulse Current for AllnGaP

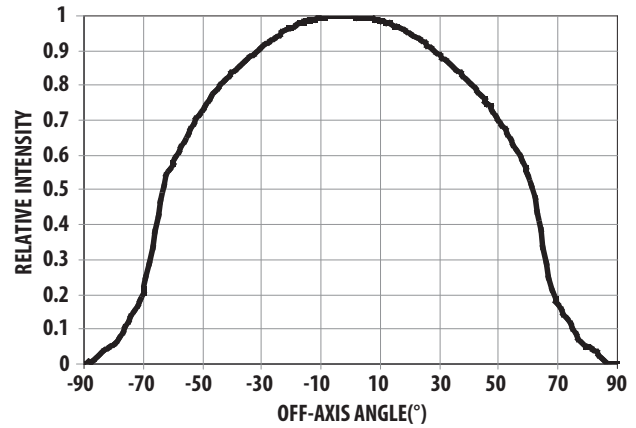

Figure 4. Radiation Pattern for AllnGaP

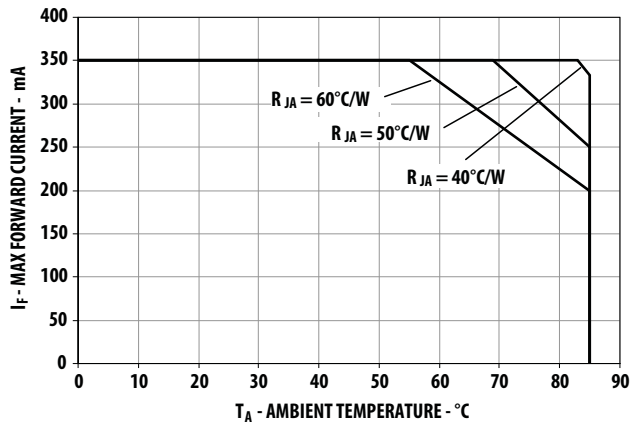

Figure 5. Maximum forward current vs. ambient temperature for AllnGaP Derated based on  $T_{j,MAX} = 125^{\circ}C$ ,  $R_{\theta_{JA}} = 40^{\circ}C/W$  /  $50^{\circ}C/W$  and  $60^{\circ}C/W$

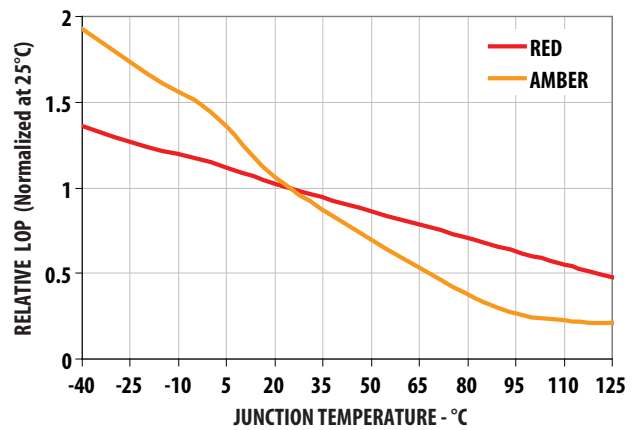

Figure 6. Relative LOP (Normalized at 25°C) vs. junction temperature for AllnGaP

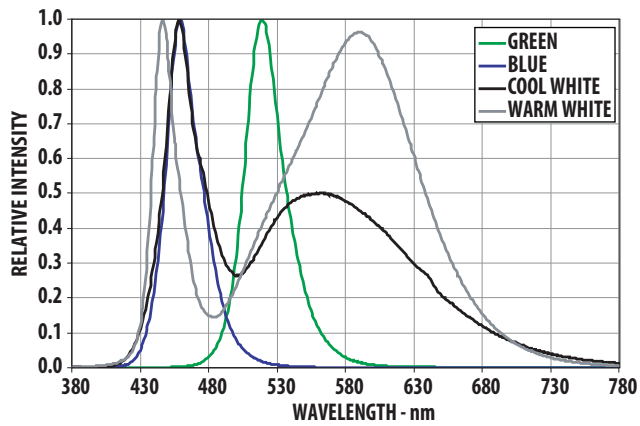

Figure 7. Relative Intensity vs. Wavelength for InGaN

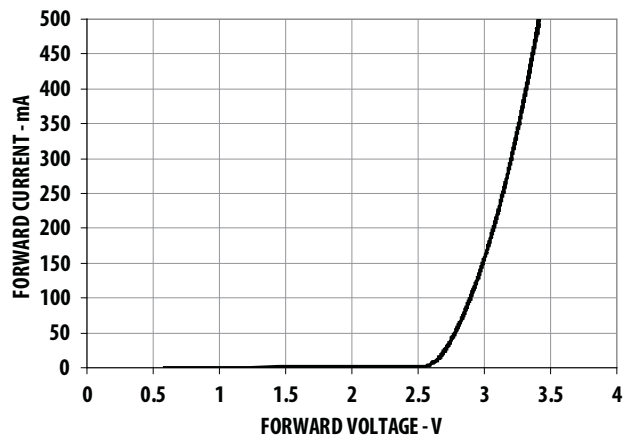

Figure 8. Forward Current vs. Forward Voltage for InGaN

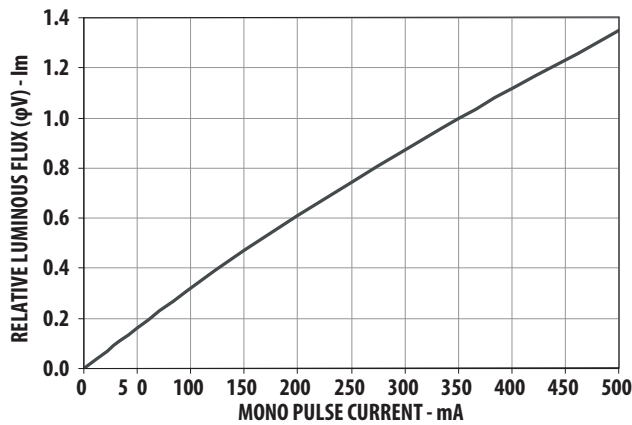

Figure 9. Relative Luminous Flux vs Mono Pulse Current for InGaN

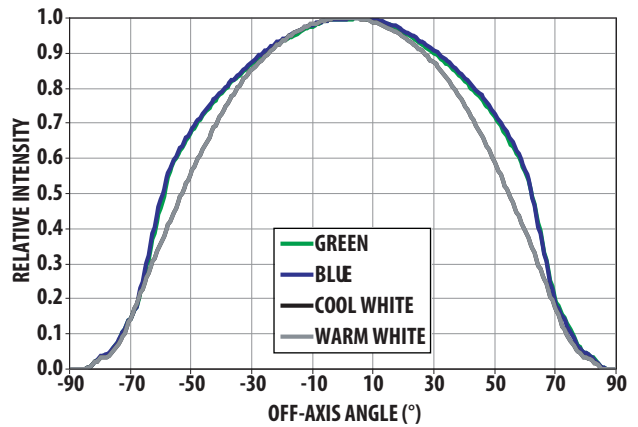

Figure 10. Radiation Pattern for InGaN

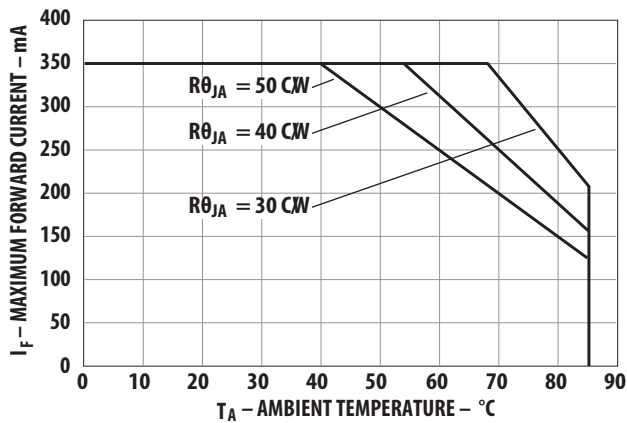

Figure 11. Maximum Forward Current vs. Ambient Temperature for InGaN Derated based on  $T_{j,MAX} = 110^\circ\text{C}$ ,  $R_{\theta JA} = 30^\circ\text{C/W}$ ,  $40^\circ\text{C/W}$  and  $50^\circ\text{C/W}$

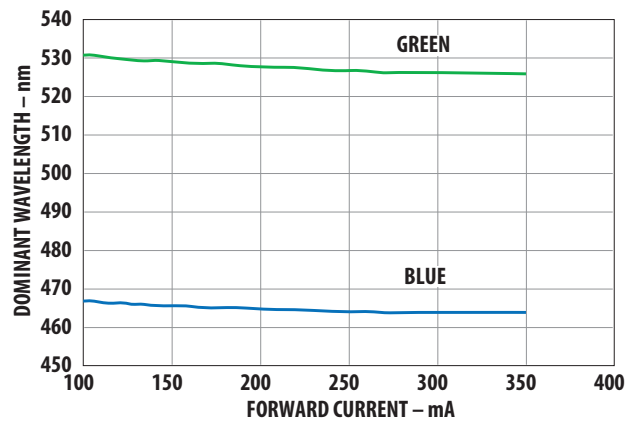

Figure 12. Dominant wavelength vs. forward current - InGaN devices

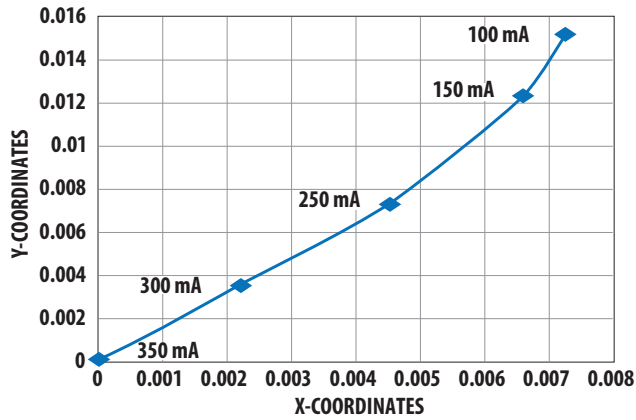

Figure 13. Chromaticity shift vs. current  
 \*Note: (x,y) values @ 350 mA reference to (0,0)

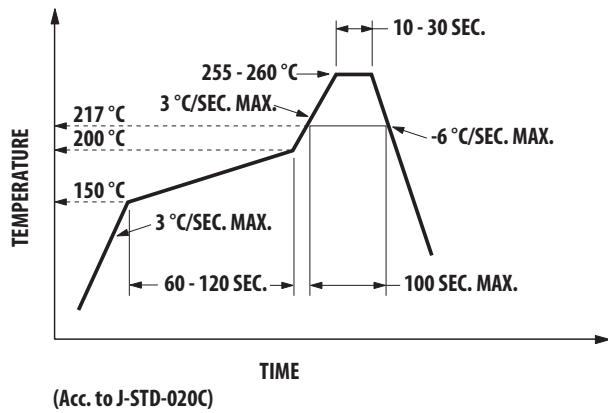

Figure 14. Recommended reflow soldering profile

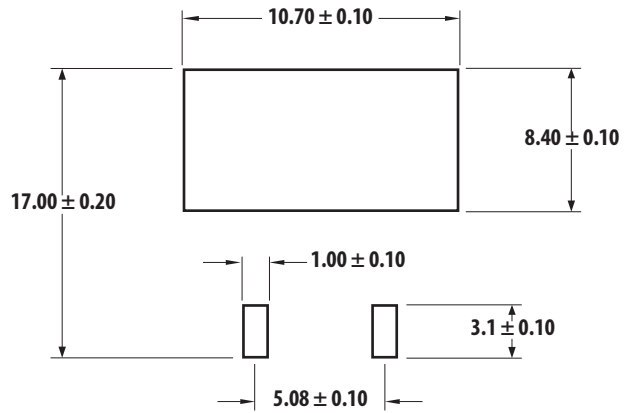

Figure 15. Recommended soldering land pattern

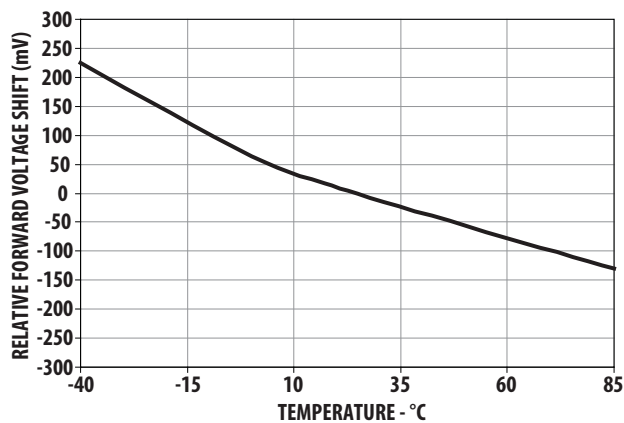

Figure 16. Temperature vs. relative forward voltage shift

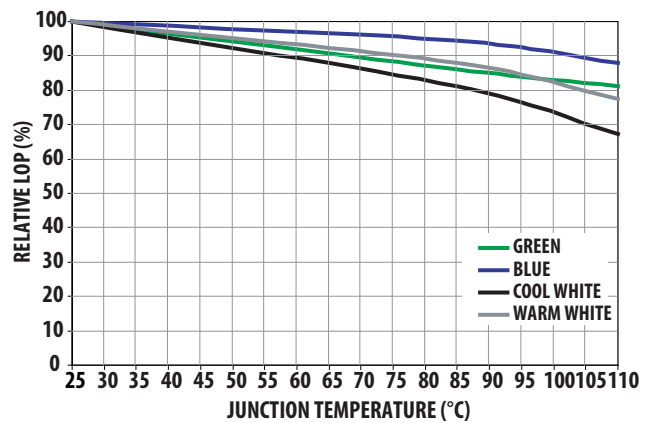

Figure 17. Relative LOP vs Junction Temperature for InGaN Devices

Note:  
 For detail information on reflow soldering of Avago surface mount LEDs, do refer to Avago Application Note AN1060 Surface Mounting SMT LED Indicator Components.

## Option Selection Details

### ASMT-Mxxx – x x<sub>1</sub> x<sub>2</sub> x<sub>3</sub> x<sub>4</sub>

x<sub>1</sub> – Minimum Flux Bin Selection

x<sub>2</sub> – Maximum Flux Bin Selection

x<sub>3</sub> – Color Bin Selection

x<sub>4</sub> – Packaging Option

## Flux Bin Limit [x<sub>1</sub> x<sub>2</sub>]

Bin	Luminous Flux (lm) at I <sub>F</sub> = 350mA	
	Min.	Max.
D	11.5	15.0
E	15.0	19.5
F	19.5	25.5
G	25.5	33.0
H	33.0	43.0
J	43.0	56.0
K	56.0	73.0

Tolerance for each bin limits is ±10%

## Color Bin Selection [x<sub>3</sub>]

Individual reel will contain parts from one full bin only.

### Warm White

0	Full Distribution
A	A only
B	B only
C	C only
D	D only
E	E only
F	F only
N	A and C only
P	B and D only
Q	E and C only
R	F and D only
U	E and F only
W	C and D only
Z	A and B only
1	A, B, C and D only
4	C, D, E and F only

### Other Colors

0	Full Distribution
Z	A and B
Y	B and C
W	C and D
V	D and E
Q	A, B and C
P	B, C and D
N	C, D and E

### Cool White

0	Full Distribution
A	A only
B	B only
C	C only
D	D only
E	E only
F	F only
G	G only
H	H only
L	A and G only
M	B and H only
N	A and C only
P	B and D only
Q	E and C only
R	F and D only
S	G and H only
U	E and F only
W	C and D only
Z	A and B only
1	A, B, C and D only
2	G, H, A and B only
4	C, D, E and F only



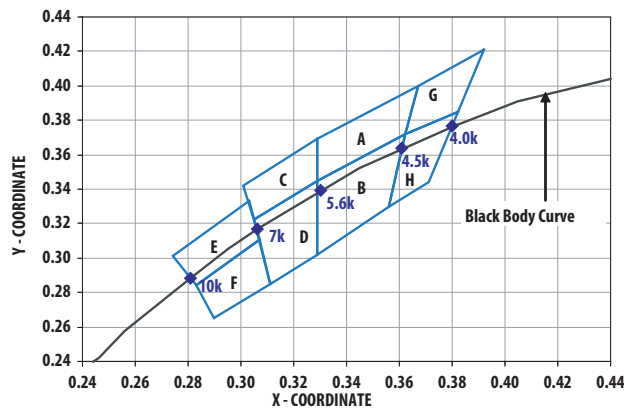

Figure 18. Color bins (Cool White).

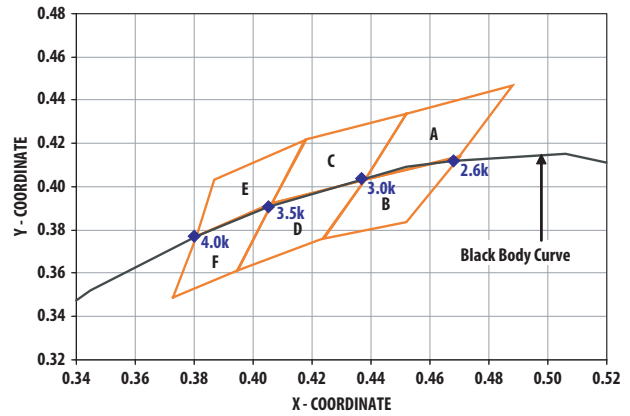

Figure 19. Color bins (Warm White).

### Color Bin Limits

Warm White	Color Limits (Chromaticity Coordinates)				
Bin A	x	0.452	0.488	0.470	0.438
	y	0.434	0.447	0.414	0.403
Bin B	x	0.438	0.470	0.452	0.424
	y	0.403	0.414	0.384	0.376
Bin C	x	0.407	0.418	0.452	0.438
	y	0.393	0.422	0.434	0.403
Bin D	x	0.395	0.407	0.438	0.424
	y	0.362	0.393	0.403	0.376
Bin E	x	0.381	0.387	0.418	0.407
	y	0.377	0.404	0.422	0.393
Bin F	x	0.373	0.381	0.407	0.395
	y	0.349	0.377	0.393	0.362

Tolerance:  $\pm 0.01$

Color	Bin	Min.	Max.
Red	Full Distribution	620.0	635.0
Amber	A	582.0	584.5
	B	584.5	587.0
	C	587.0	589.5
	D	589.5	592.0
	E	592.0	594.5
Blue	A	455.0	460.0
	B	460.0	465.0
	C	465.0	470.0
	D	470.0	475.0
Green	A	515.0	520.0
	B	520.0	525.0
	C	525.0	530.0
	D	530.0	535.0

Tolerance:  $\pm 1$  nm

Cool White	Color Limits (Chromaticity Coordinates)				
Bin A	x	0.367	0.362	0.329	0.329
	y	0.400	0.372	0.345	0.369
Bin B	x	0.362	0.356	0.329	0.329
	y	0.372	0.330	0.302	0.345
Bin C	x	0.329	0.329	0.305	0.301
	y	0.369	0.345	0.322	0.342
Bin D	x	0.329	0.329	0.311	0.305
	y	0.345	0.302	0.285	0.322
Bin E	x	0.303	0.307	0.283	0.274
	y	0.333	0.311	0.284	0.301
Bin F	x	0.307	0.311	0.290	0.283
	y	0.311	0.285	0.265	0.284
Bin G	x	0.388	0.379	0.362	0.367
	y	0.417	0.383	0.372	0.400
Bin H	x	0.379	0.369	0.356	0.362
	y	0.383	0.343	0.330	0.372

Tolerance:  $\pm 0.01$

## Sub-Color Binning

(Only Applicable for Color Bin A to Bin D and Bin G to Bin H)

### Color Limits

Cool White	(Chromaticity Coordinates)				
Bin A1	X	0.364	0.367	0.348	0.347
	Y	0.383	0.400	0.385	0.372
Bin A2	X	0.364	0.362	0.346	0.347
	Y	0.383	0.372	0.359	0.372
Bin A3	X	0.329	0.329	0.348	0.347
	Y	0.357	0.369	0.385	0.372
Bin A4	X	0.329	0.329	0.347	0.346
	Y	0.345	0.357	0.372	0.359
Bin B1	X	0.362	0.360	0.344	0.346
	Y	0.372	0.357	0.344	0.359
Bin B2	X	0.360	0.358	0.343	0.344
	Y	0.357	0.343	0.331	0.344
Bin B3	X	0.358	0.356	0.341	0.343
	Y	0.343	0.330	0.314	0.331
Bin B4	X	0.329	0.329	0.346	0.344
	Y	0.331	0.345	0.359	0.344
Bin B5	X	0.329	0.344	0.343	0.329
	Y	0.331	0.344	0.331	0.320
Bin B6	X	0.343	0.341	0.329	0.329
	Y	0.331	0.314	0.302	0.320
Bin C1	X	0.329	0.329	0.315	0.314
	Y	0.369	0.357	0.344	0.355
Bin C2	X	0.329	0.329	0.316	0.315
	Y	0.357	0.345	0.333	0.344
Bin C3	X	0.314	0.315	0.303	0.301
	Y	0.355	0.344	0.333	0.342
Bin C4	X	0.315	0.316	0.305	0.303
	Y	0.344	0.333	0.322	0.333

Cool White	(Chromaticity Coordinates)				
Bin D1	X	0.329	0.329	0.317	0.316
	Y	0.345	0.331	0.320	0.333
Bin D2	X	0.329	0.329	0.318	0.317
	Y	0.331	0.320	0.310	0.320
Bin D3	X	0.329	0.329	0.320	0.318
	Y	0.320	0.302	0.293	0.310
Bin D4	X	0.316	0.317	0.307	0.305
	Y	0.333	0.320	0.311	0.322
Bin D5	X	0.317	0.318	0.309	0.307
	Y	0.320	0.310	0.300	0.311
Bin D6	X	0.318	0.320	0.311	0.309
	Y	0.310	0.293	0.285	0.300
Bin G1	X	0.392	0.386	0.364	0.367
	Y	0.421	0.400	0.383	0.400
Bin G2	X	0.386	0.382	0.362	0.364
	Y	0.400	0.385	0.372	0.383
Bin H1	X	0.382	0.378	0.360	0.362
	Y	0.385	0.370	0.357	0.372
Bin H2	X	0.378	0.375	0.358	0.360
	Y	0.370	0.358	0.343	0.357
Bin H3	X	0.375	0.371	0.356	0.358
	Y	0.358	0.344	0.330	0.343

Tolerances  $\pm 0.01$

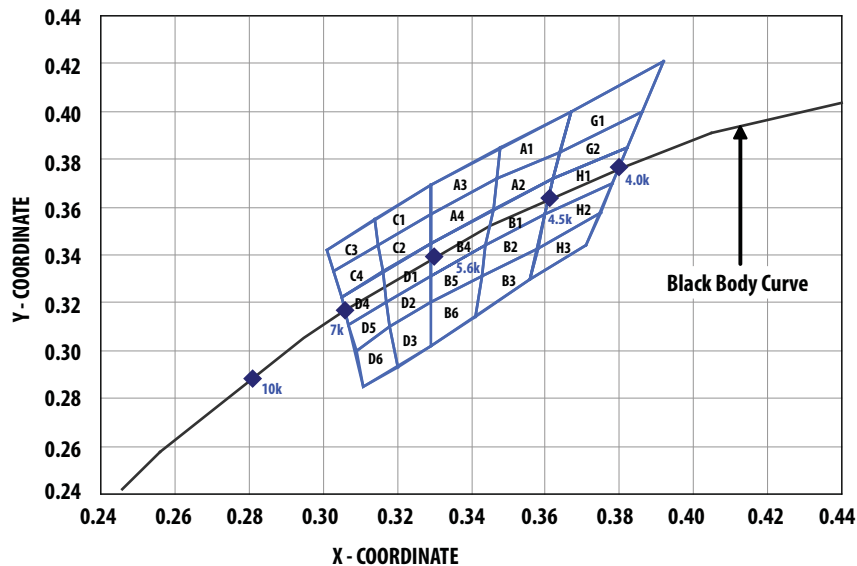

Figure 20. Sub-color bins (Cool White)

### Packaging option [x<sub>4</sub>]

Selection	Option
0	Tube
1	Tape & Reel

### Example

#### ASMT-MR00-AHJ00

- ASMT-MR00-Axxxx - AllnGaP Red, Non-diffused
- x<sub>1</sub> = H - Minimum Flux Bin H
  - x<sub>2</sub> = J - Maximum Flux Bin J
  - x<sub>3</sub> = 0 - Full Distribution
  - x<sub>4</sub> = 0 - Tube Option

### Packing Tube - Option 0

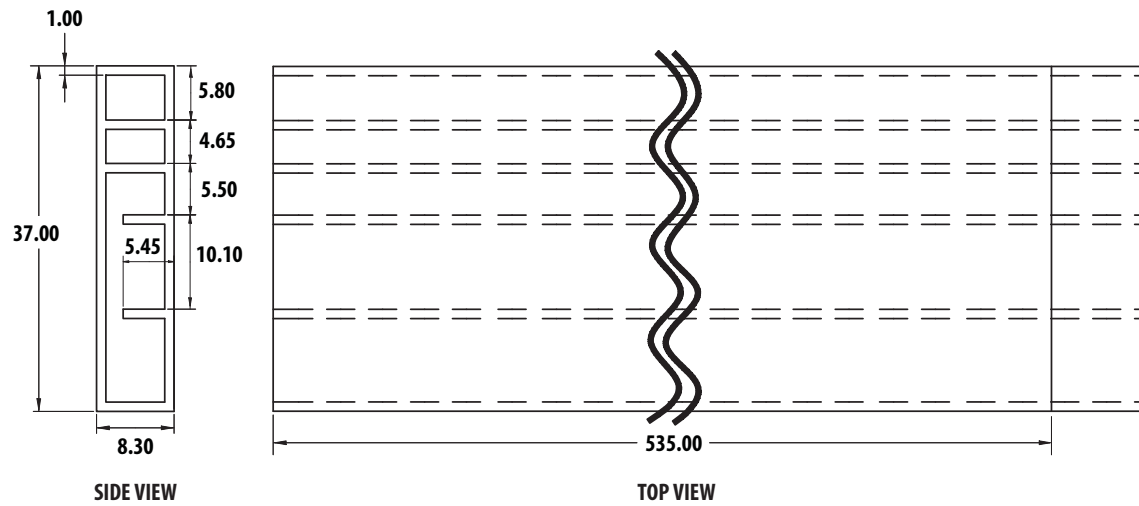

Figure 21. Tube dimensions

### Tape & Reel - Option 1

#### Tape Dimension

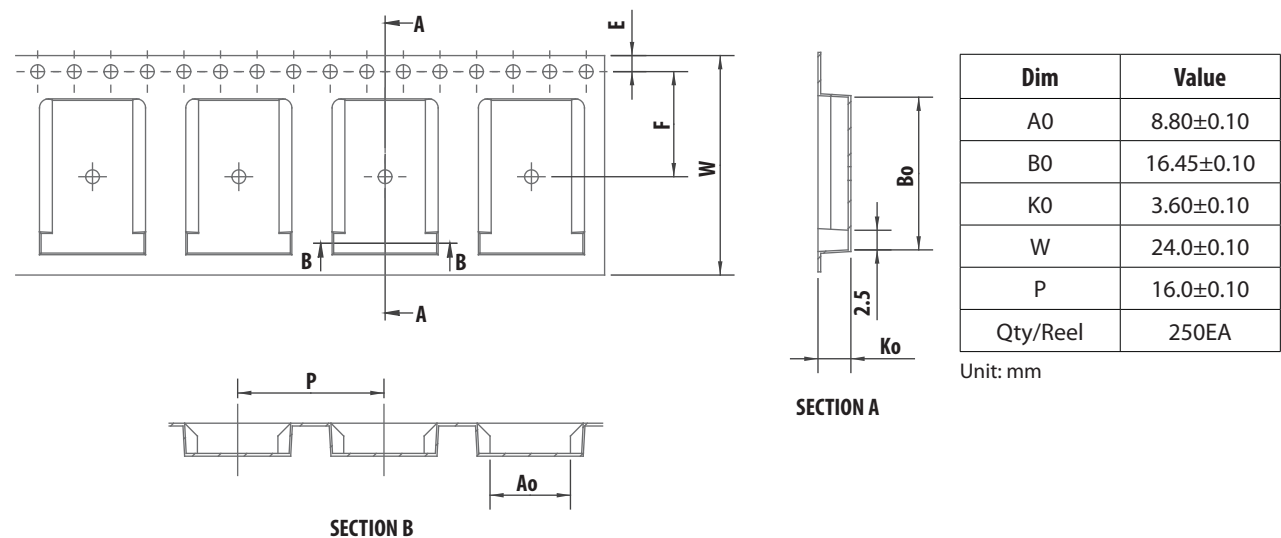

Figure 22. Carrier tape dimensions

## Tape & Reel - Option 1 (Cont.)

### Tape Dimension

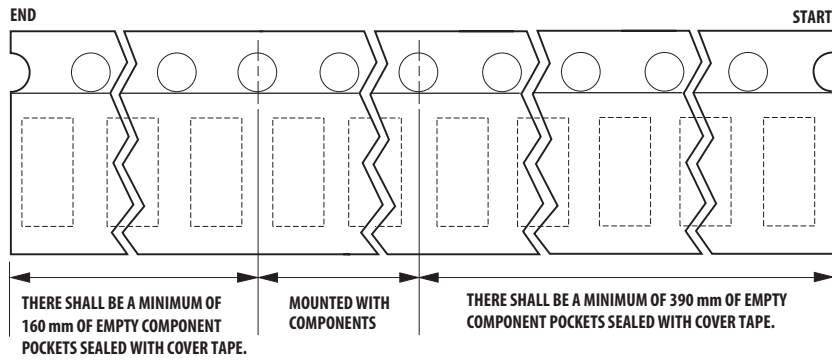

Figure 23. Carrier tape leader and trailer dimensions

### Reel Dimensions

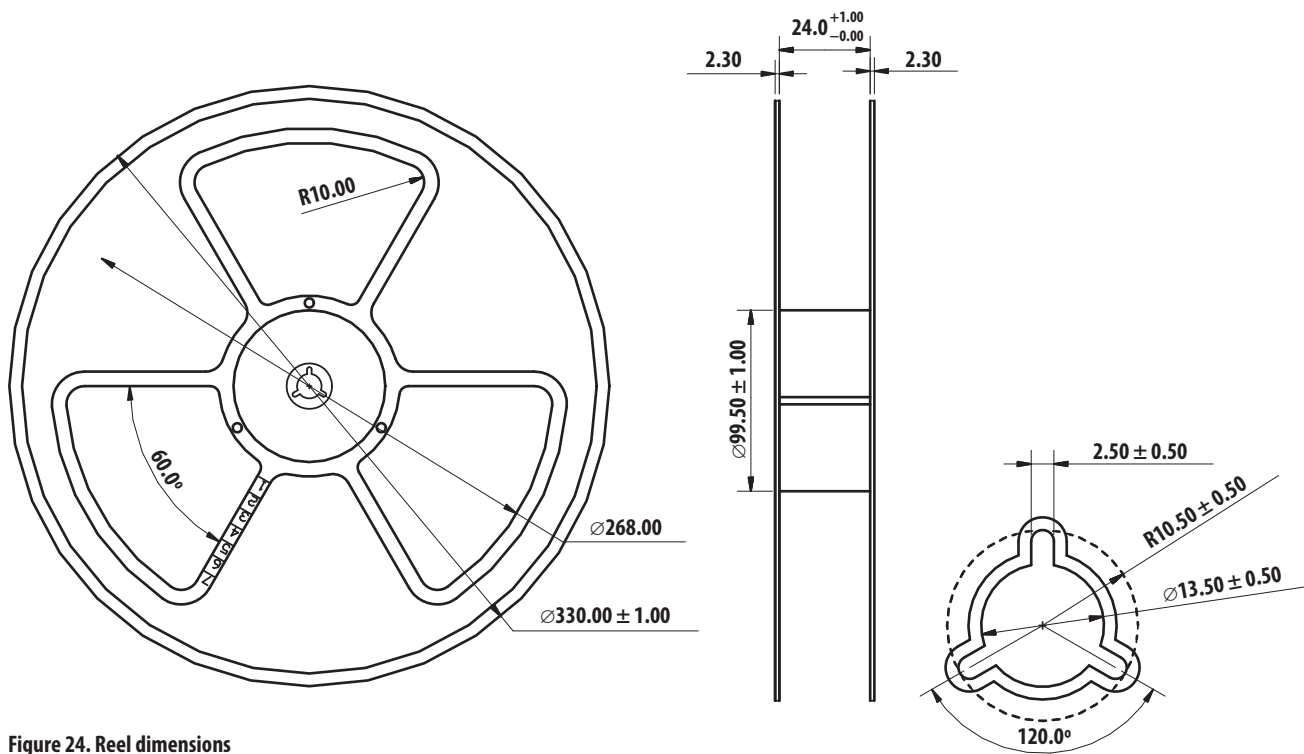

Figure 24. Reel dimensions

## Handling Precaution

The encapsulation material of the product is made of silicone for better reliability of the product. As silicone is a soft material, please do not press on the silicone or poke a sharp object onto the silicone. These might damage the product and cause premature failure. During assembly or handling, the unit should be held on the body only. Please refer to Avago Application Note AN5288 for detail information.

## Moisture Sensitivity

This product is qualified as Moisture Sensitive Level 2a for InGaN devices and MSL 4 for AlInGaP devices per Jedec J-STD-020. Precautions when handling this moisture sensitive product is important to ensure the reliability of the product. Do refer to Avago Application Note AN5305 Handling of Moisture Sensitive Surface Mount Devices for details.

### A. Storage before use

- Unopen moisture barrier bag (MBB) can be stored at <40°C/90%RH for 12 months. If the actual shelf life has exceeded 12 months and the humidity indicator card (HIC) indicates that baking is not required, then it is safe to reflow the LEDs per the original MSL rating.
- It is not recommended to open the MBB prior to assembly (e.g. for IQC).

### B. Control after opening the MBB

- The humidity indicator card (HIC) shall be read immediately upon opening of MBB.
- The LEDs must be kept at <30°C/60%RH at all time and all high temperature related process including soldering, curing or rework need to be completed within 672 hours for MSL 2a and 72 hours for MSL 4.

### C. Control for unfinished reel

- For any unused LEDs, they need to be stored in sealed MBB with desiccant or desiccator at <5%RH.

### D. Control of assembly boards

- If the PCB soldered with the LEDs is to be subjected to other high temperature processes, the PCB need to be stored in sealed MBB with desiccant or desiccator at <5%RH to ensure no LEDs have exceeded their floor life of 672 hours for MSL 2a and 72 hours for MSL 4.

### E. Baking is required if

- HIC "10%" indicator is not blue and "5%" indicator is pink. - The LEDs are exposed to condition of >30°C/60% RH at any time.
- The LEDs floor life exceeded 672 hours for MSL 2a and 72 hours for MSL 4.

Recommended baking condition: 60±5°C for 20hrs.

### DISCLAIMER

AVAGO'S PRODUCTS AND SOFTWARE ARE NOT SPECIFICALLY DESIGNED, MANUFACTURED OR AUTHORIZED FOR SALE AS PARTS, COMPONENTS OR ASSEMBLIES FOR THE PLANNING, CONSTRUCTION, MAINTENANCE OR DIRECT OPERATION OF A NUCLEAR FACILITY OR FOR USE IN MEDICAL DEVICES OR APPLICATIONS. CUSTOMER IS SOLELY RESPONSIBLE, AND WAIVES ALL RIGHTS TO MAKE CLAIMS AGAINST AVAGO OR ITS SUPPLIERS, FOR ALL LOSS, DAMAGE, EXPENSE OR LIABILITY IN CONNECTION WITH SUCH USE.

For product information and a complete list of distributors, please go to our web site: [www.avagotech.com](http://www.avagotech.com)