

N-channel MOSFET

Features

- High ruggedness
- $R_{DS(ON)}$ (Max 1.1Ω)@ $V_{GS}=10V$
- Gate Charge (Typ 47nC)
- Improved dv/dt Capability
- 100% Avalanche Tested

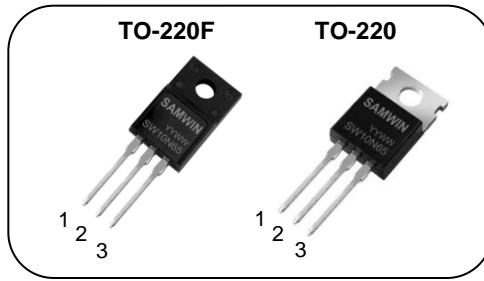

1. Gate 2. Drain 3. Source

BV_{DSS} : 650V
 I_D : 10.0A
 $R_{DS(ON)}$: 1.1ohm

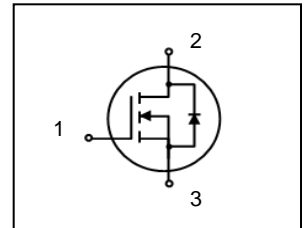

General Description

This power MOSFET is produced with advanced VDMOS technology of SAMWIN. This technology enable power MOSFET to have better characteristics, such as fast switching time, low on resistance, low gate charge and especially excellent avalanche characteristics. It is mainly suitable for half bridge or full bridge resonant topology like a electronic ballast, and also low power switching mode power appliances.

Order Codes

Item	Sales Type	Marking	Package	Packaging
1	SW P 10N65	SW10N65	TO-220	TUBE
2	SW F 10N65	SW10N65	TO-220F	TUBE

Absolute maximum ratings

Symbol	Parameter	Value		Unit
		TO-220	TO-220F	
V_{DSS}	Drain to Source Voltage	650		V
I_D	Continuous Drain Current (@ $T_C=25^\circ C$)	10.0	10.0*	A
	Continuous Drain Current (@ $T_C=100^\circ C$)	5.7	5.7*	A
I_{DM}	Drain current pulsed (note 1)	36		A
V_{GS}	Gate to Source Voltage	± 30		V
E_{AS}	Single pulsed Avalanche Energy (note 2)	700		mJ
E_{AR}	Repetitive Avalanche Energy (note 1)	15.6		mJ
dv/dt	Peak diode Recovery dv/dt (note 3)	4.5		V/ns
P_D	Total power dissipation (@ $T_C=25^\circ C$)	156	50*	W
	Derating Factor above 25°C	1.25	0.4	W/°C
T_{STG}, T_J	Operating Junction Temperature & Storage Temperature	-55 ~ + 150		°C
T_L	Maximum Lead Temperature for soldering purpose, 1/8 from Case for 5 seconds.	300		°C

*. Drain current is limited by junction temperature.

Thermal characteristics

Symbol	Parameter	Value		Unit
		TO-220	TO-220F	
R_{thic}	Thermal resistance, Junction to case	0.8	2.5	°C/W
R_{thcs}	Thermal resistance, Case to Sink	0.5		°C/W
R_{thia}	Thermal resistance, Junction to ambient	62.5		°C/W

Electrical characteristic ($T_C = 25^\circ\text{C}$ unless otherwise specified)

Symbol	Parameter	Test conditions	Min.	Typ.	Max.	Unit
Off characteristics						
BV_{DSS}	Drain to source breakdown voltage	$V_{GS}=0V, I_D=250\mu A$	650	-	-	V
$\Delta BV_{DSS} / \Delta T_J$	Breakdown voltage temperature coefficient	$I_D=250\mu A$, referenced to 25°C	-	0.56	-	$V/^\circ\text{C}$
I_{DSS}	Drain to source leakage current	$V_{DS}=650V, V_{GS}=0V$	-	-	1	μA
		$V_{DS}=520V, T_C=125^\circ\text{C}$	-	-	50	μA
I_{GSS}	Gate to source leakage current, forward	$V_{GS}=30V, V_{DS}=0V$	-	-	100	nA
	Gate to source leakage current, reverse	$V_{GS}=-30V, V_{DS}=0V$	-	-	-100	nA
On characteristics						
$V_{GS(TH)}$	Gate threshold voltage	$V_{DS}=V_{GS}, I_D=250\mu A$	2.0	-	4.0	V
$R_{DS(ON)}$	Drain to source on state resistance	$V_{GS}=10V, I_D = 5.0A$		0.85	1.1	Ω
Dynamic characteristics						
C_{iss}	Input capacitance	$V_{GS}=0V, V_{DS}=25V, f=1\text{MHz}$		1740	2530	pF
C_{oss}	Output capacitance			156	205	
C_{riss}	Reverse transfer capacitance			37	42	
$t_{d(on)}$	Turn on delay time	$V_{DS}=300V, I_D=10A, R_G=25\Omega$			60	ns
t_r	Rising time				180	
$t_{d(off)}$	Turn off delay time				200	
t_f	Fall time				120	
Q_g	Total gate charge	$V_{DS}=520V, V_{GS}=10V, I_D=10A$		37	60	nC
Q_{gs}	Gate-source charge			10	-	
Q_{gd}	Gate-drain charge			25	-	

Source to drain diode ratings characteristics

Symbol	Parameter	Test conditions	Min.	Typ.	Max.	Unit
I_S	Continuous source current	Integral reverse p-n Junction diode in the MOSFET	-	-	10	A
I_{SM}	Pulsed source current		-	-	36	A
V_{SD}	Diode forward voltage drop.	$I_S=10A, V_{GS}=0V$	-	-	1.5	V
T_{rr}	Reverse recovery time	$I_S=10A, V_{GS}=0V,$	-	470	-	ns
Q_{rr}	Breakdown voltage temperature	$di_F/dt=100A/\mu s$	-	4.3	-	μC

※. Notes

1. Repetitive rating : pulse width limited by junction temperature.
2. $L = 14.2\text{mH}, I_{AS} = 10.0A, V_{DD} = 50V, R_G=25\Omega$, Starting $T_J = 25^\circ\text{C}$
3. $I_{SD} \leq 10.0A, di/dt = 200A/\mu s, V_{DD} \leq BV_{DSS}$, Starting $T_J = 25^\circ\text{C}$
4. Pulse Test : Pulse Width $\leq 300\mu s$, duty cycle $\leq 2\%$
5. Essentially independent of operating temperature.

Fig. 1. On-state characteristics

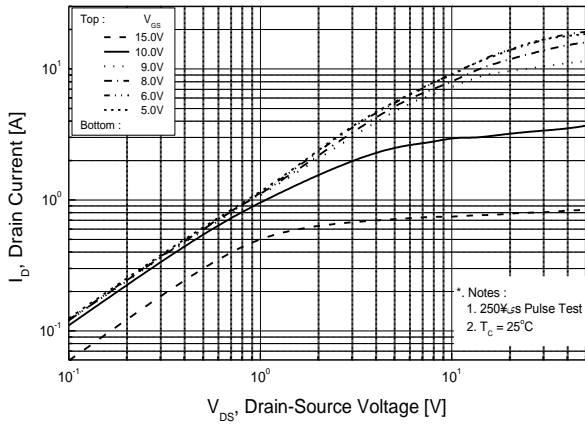

Fig. 2. Transfer characteristics

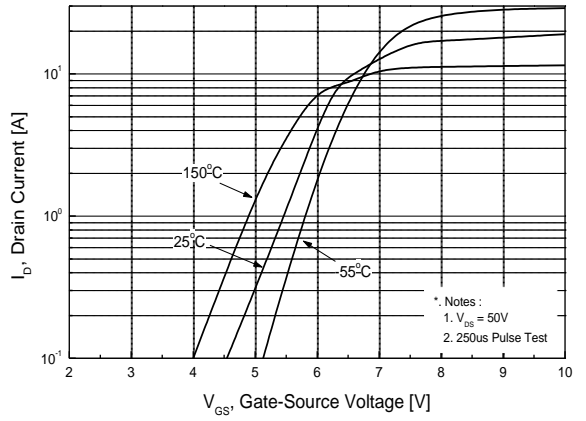

Fig. 3. On-resistance variation vs. drain current and gate voltage

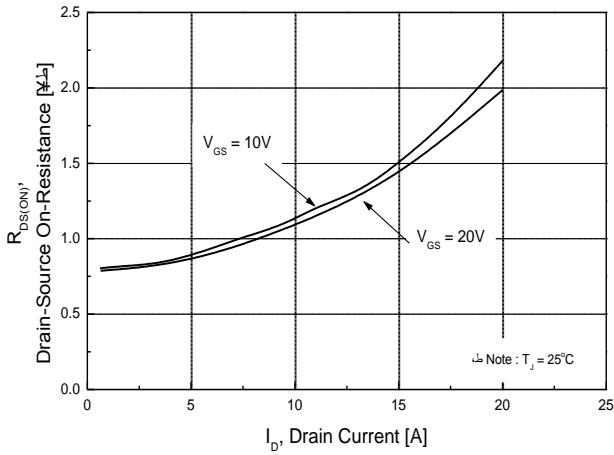

Fig. 4. On state current vs. diode forward voltage

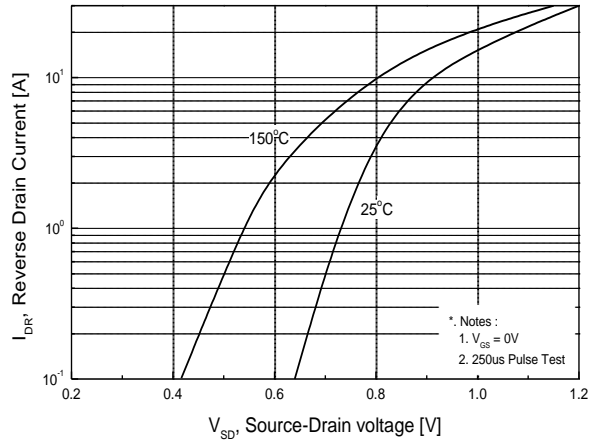

Fig. 5. Capacitance characteristics (Non-Repetitive)

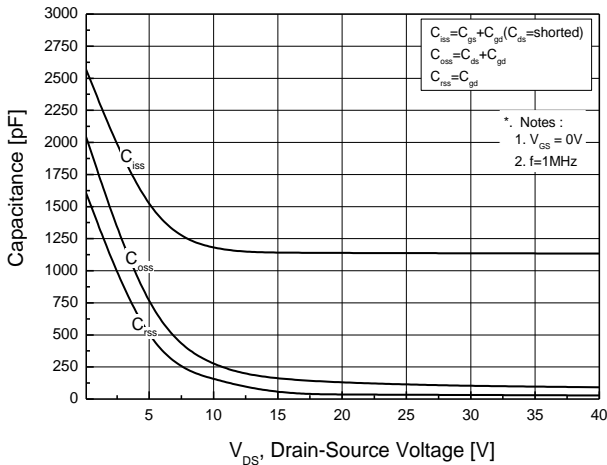

Fig. 6. Gate charge characteristics

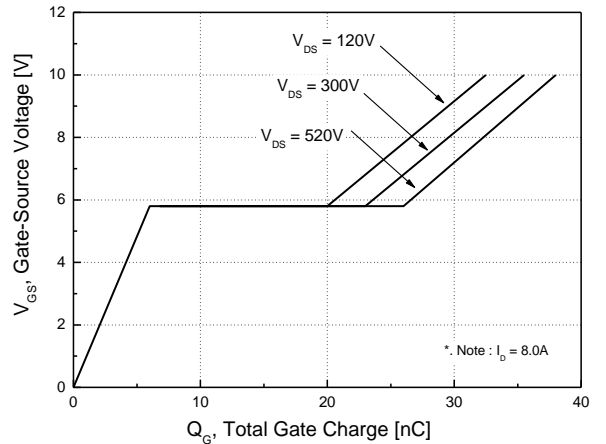

Fig 7. Breakdown Voltage Variation vs. Junction Temperature

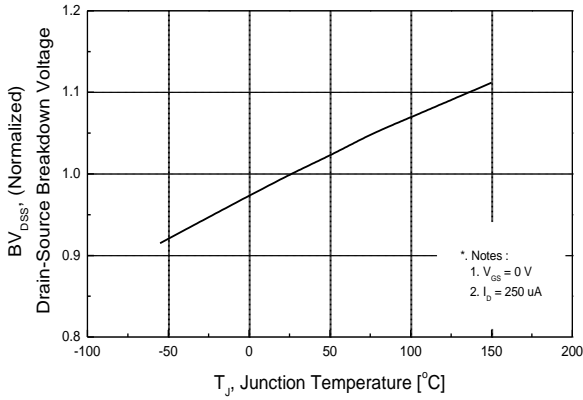

Fig. 8. On resistance variation vs. junction temperature

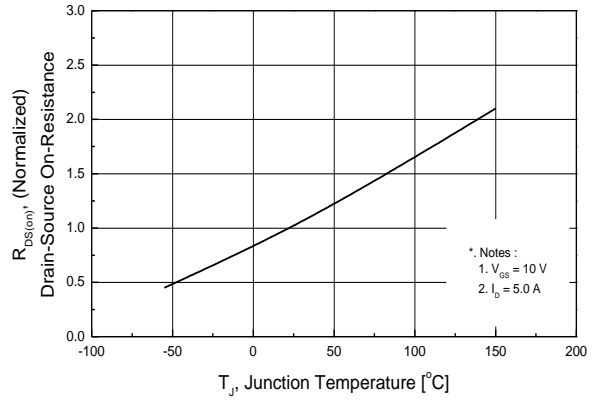

Fig. 9. Maximum drain current vs. case temperature.

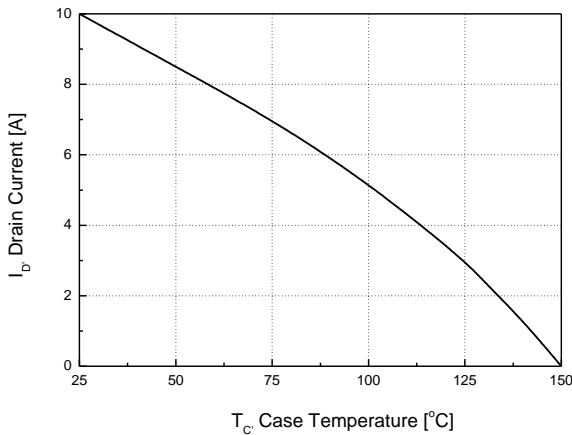

Fig. 10. Maximum safe operating area

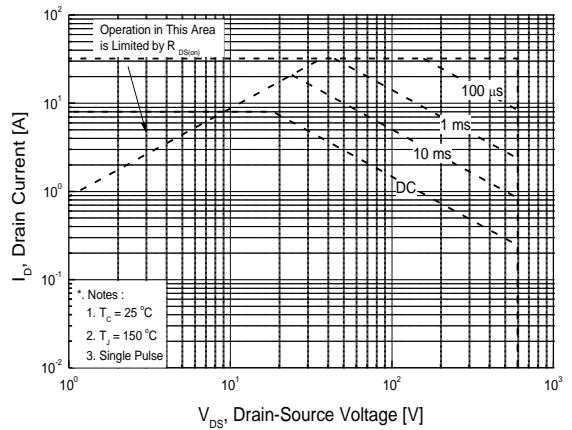

Fig. 11. Transient thermal response curve

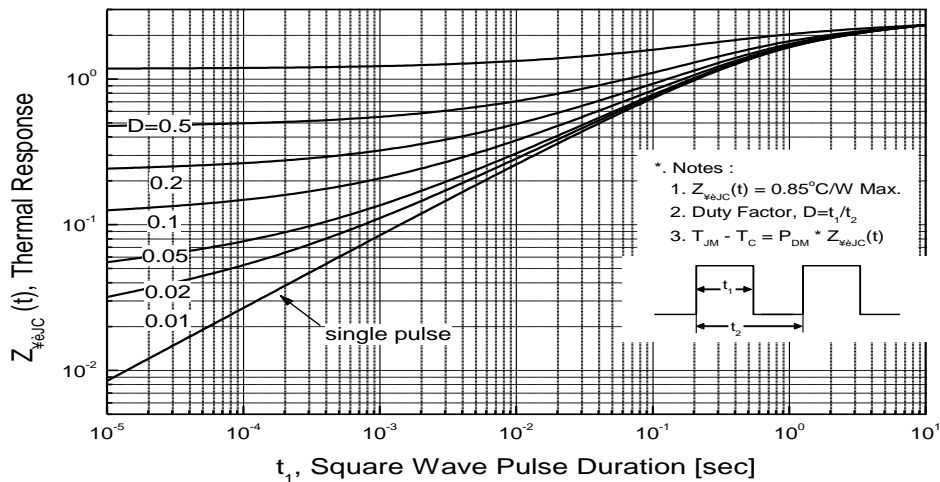

Fig. 12. Gate charge test circuit & waveform

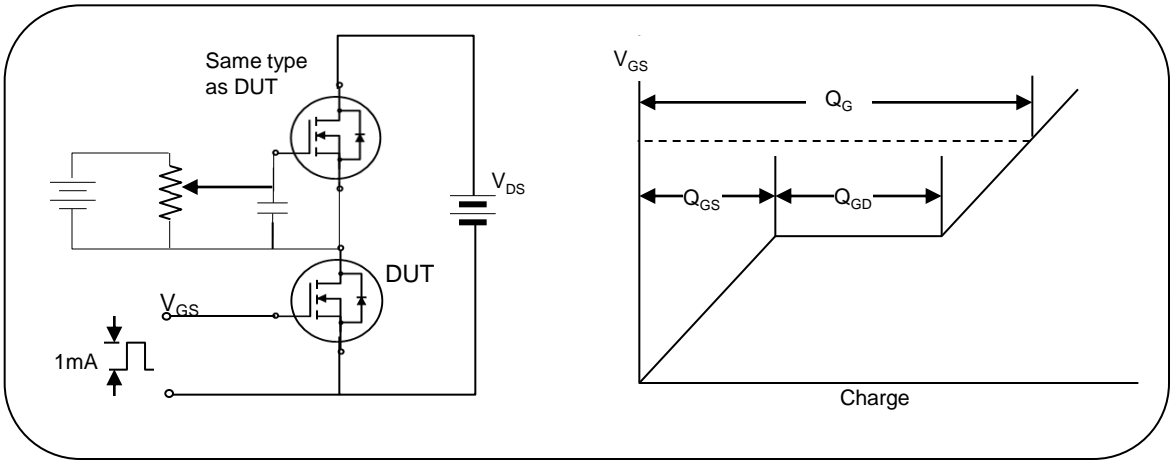

Fig. 13. Switching time test circuit & waveform

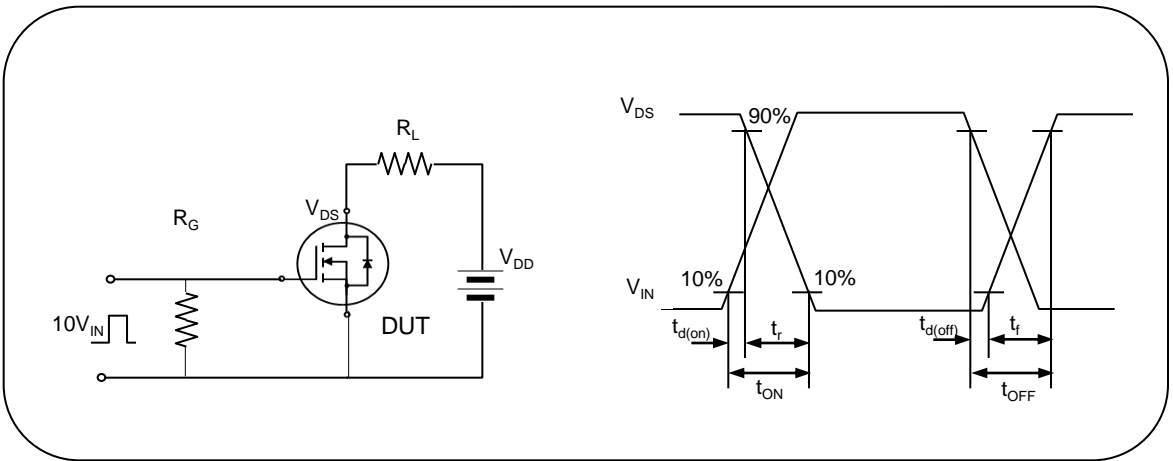

Fig. 14. Unclamped Inductive switching test circuit & waveform

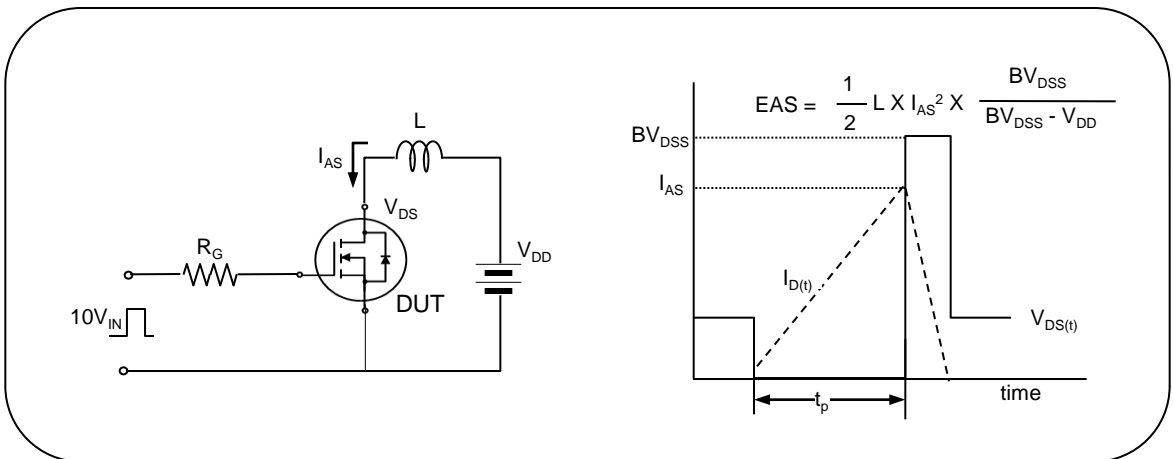
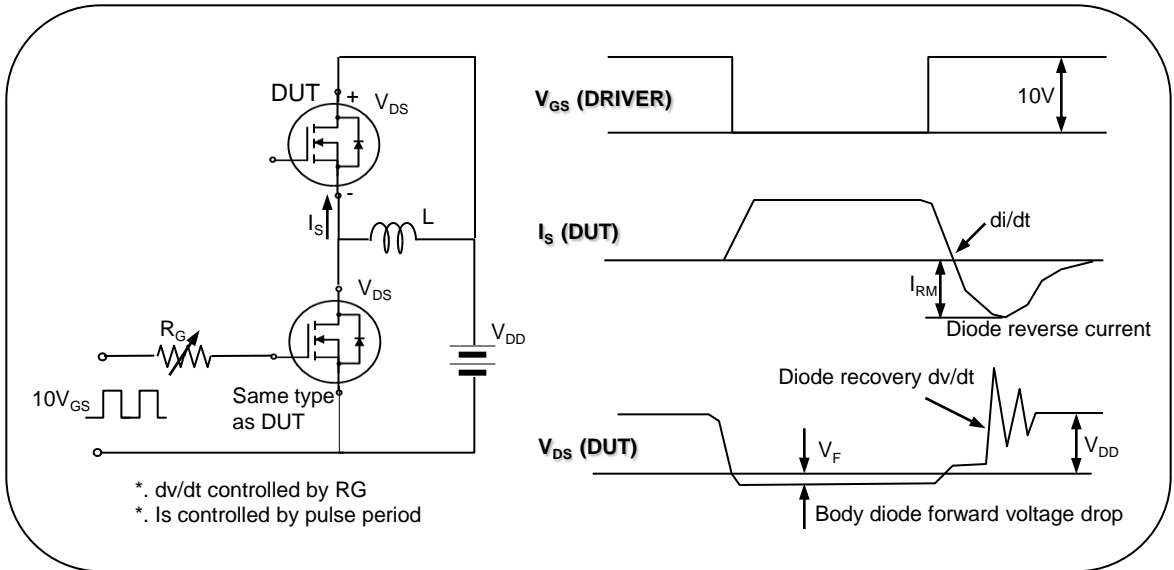

Fig. 15. Peak diode recovery dv/dt test circuit & waveform



REVISION HISTORY

Revision No.	Changed Characteristics	Responsible	Date	Issuer
REV 1.0	Origination, First Release	Alice Nie	2007.12.05	XZQ
REV 2.0	Updated the format of datasheet and added Order Codes.	Alice Nie	2011.03.24	XZQ

WWW.SEMIPOWER.COM.CN



芯派科技
SEMIPOWER

西安芯派电子科技有限公司

地址：西安市高新区高新一路25号创新大厦MF6

电话：029 - 88253717 传真：029 - 88251977



芯源科技

SAMWIN

深圳市南方芯源科技有限公司

地址：深圳市福田区天安数码城时代大厦A座2005

电话：0755 - 83981818 传真：0755 - 83476838