



± 2g / 4g / 8g Tri-axis Digital Accelerometer Specifications

PART NUMBER:

KXTIK-1004
Rev. 2
Dec-2011

Product Description

The KXTIK is a tri-axis +/-2g, +/-4g or +/-8g silicon micromachined accelerometer with integrated orientation, tap/double tap, and activity detecting algorithms. The sense element is fabricated using Kionix's proprietary plasma micromachining process technology. Acceleration sensing is based on the principle of a differential capacitance arising from acceleration-induced motion of the sense element, which further utilizes common mode cancellation to decrease errors from process variation, temperature, and environmental stress. The sense element is hermetically sealed at the wafer level by bonding a second silicon lid wafer to the device using a glass frit. A separate ASIC device packaged with the sense element provides signal conditioning, and intelligent user-programmable application algorithms. The accelerometer is delivered in a 3 x 3 x 0.9 mm LGA plastic package operating from a 1.8 – 3.6V DC supply. Voltage regulators are used to maintain constant internal operating voltages over the range of input supply voltages. This results in stable operating characteristics over the range of input supply voltages and virtually undetectable ratiometric error. I²C digital protocol is used to communicate with the chip to configure and check for updates to the orientation, Directional TapTM detection and activity monitoring algorithms.

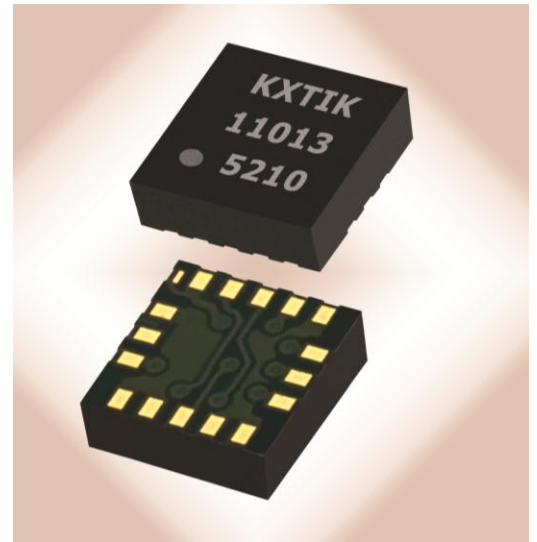



± 2g / 4g / 8g Tri-axis Digital Accelerometer Specifications

PART NUMBER:

KXTIK-1004
Rev. 2
Dec-2011

Functional Diagram

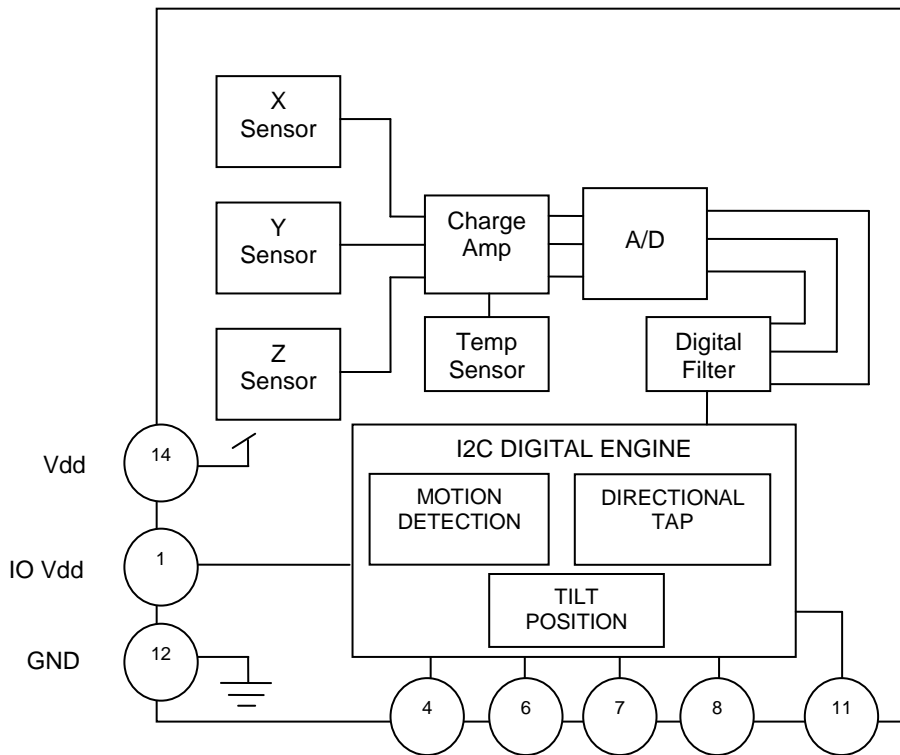



± 2g / 4g / 8g Tri-axis Digital Accelerometer Specifications

PART NUMBER:

**KXTIK-1004
Rev. 2
Dec-2011**

Product Specifications

Table 1. Mechanical

(specifications are for operation at 2.6V and T = 25C unless stated otherwise)

Parameters		Units	Min	Typical	Max
Operating Temperature Range		°C	-40	-	85
Zero-g Offset		mg		±25	±125
Zero-g Offset Variation from RT over Temp.		mg/°C		0.7 (xy) 0.4 (z)	
Sensitivity (12-bit) ¹	GSEL1=0, GSEL0=0 (± 2g)	counts/g	988	1024	1060
	GSEL1=0, GSEL0=1 (± 4g)		494	512	530
	GSEL1=1, GSEL0=0 (± 8g)		247	256	265
Sensitivity (8-bit) ¹	GSEL1=0, GSEL0=0 (± 2g)	counts/g	61	64	67
	GSEL1=0, GSEL0=1 (± 4g)		30	32	34
	GSEL1=1, GSEL0=0 (± 8g)		15	16	17
Sensitivity Variation from RT over Temp.		%/°C		0.01 (xy) 0.03 (z)	
Self Test Output change on Activation		g		0.7 (xy) 0.5 (z)	
Mechanical Resonance (-3dB) ²		Hz		3500 (xy) 1800 (z)	
Non-Linearity		% of FS		0.6	
Cross Axis Sensitivity		%		2	

Notes:

1. Resolution and acceleration ranges are user selectable via I²C.
2. Resonance as defined by the damped mechanical sensor.



± 2g / 4g / 8g Tri-axis Digital Accelerometer Specifications

PART NUMBER:

**KXTIK-1004
Rev. 2
Dec-2011**

Table 2. Electrical

(specifications are for operation at 2.6V and T = 25C unless stated otherwise)

Parameters		Units	Min	Typical	Max
Supply Voltage (V _{dd})	Operating	V	1.71	2.6	3.6
I/O Pads Supply Voltage (V _{IO})		V	1.7		V _{dd}
Current Consumption	All On (RES = 1)	μA		325	
	Directional Tap™ (RES = 0, ODR = 400Hz)			165	
	Low Power (RES = 0, ODR ≤ 25Hz)			100	
	Standby			10	
Output Low Voltage (V _{io} < 2V) ¹		V	-	-	0.2 * V _{io}
Output Low Voltage (V _{io} > 2V) ¹		V	-	-	0.4
Output High Voltage		V	0.8 * V _{io}	-	-
Input Low Voltage		V	-	-	0.2 * V _{io}
Input High Voltage		V	0.8 * V _{io}	-	-
Input Pull-down Current		μA		0	
Start Up Time ²	RES = 0	ms		0.050	
	RES = 1, ODR = 12.5Hz			81	
	RES = 1, ODR = 25 Hz			41	
	RES = 1, ODR = 50Hz			21	
	RES = 1, ODR = 100Hz			11	
	RES = 1, ODR = 200Hz			6	
	RES = 1, ODR = 400Hz			4	
	RES = 1, ODR = 800Hz			2.5	
Power Up Time ³		ms		10	
I ² C Communication Rate		kHz			400
Output Data Rate (ODR) ⁴		Hz	12.5	50	800
Bandwidth (-3dB) ⁵	RES = 0	kHz		1.59	
	RES = 1	Hz		ODR/2	

Notes:

1. For I²C communication, this assumes a minimum 1.5kΩ pull-up resistor on SCL and SDA pins.
2. Start up time is from PC1 set to valid outputs.
3. Power up time is from V_{dd} valid to device boot completion.
4. User selectable through I²C.
5. User selectable and dependant on ODR and RES.

	± 2g / 4g / 8g Tri-axis Digital Accelerometer Specifications	PART NUMBER: KXTIK-1004 Rev. 2 Dec-2011
---	---	--

Table 3. Environmental

Parameters		Units	Min	Typical	Max
Supply Voltage (V _{dd})	Absolute Limits	V	-0.5	-	3.63
Operating Temperature Range		°C	-40	-	85
Storage Temperature Range		°C	-55	-	150
Mech. Shock (powered and unpowered)		g	-	-	5000 for 0.5ms 10000 for 0.2ms
ESD	HBM	V	-	-	2000



Caution: ESD Sensitive and Mechanical Shock Sensitive Component, improper handling can cause permanent damage to the device.



This product conforms to Directive 2002/95/EC of the European Parliament and of the Council of the European Union (RoHS). Specifically, this product does not contain lead, mercury, cadmium, hexavalent chromium, polybrominated biphenyls (PBB), or polybrominated diphenyl ethers (PBDE) above the maximum concentration values (MCV) by weight in any of its homogenous materials. Homogenous materials are "of uniform composition throughout."



This product is halogen-free per IEC 61249-2-21. Specifically, the materials used in this product contain a maximum total halogen content of 1500 ppm with less than 900-ppm bromine and less than 900-ppm chlorine.

Soldering

Soldering recommendations are available upon request or from www.kionix.com.



± 2g / 4g / 8g Tri-axis Digital Accelerometer Specifications

PART NUMBER:

**KXTIK-1004
Rev. 2
Dec-2011**

Application Schematic

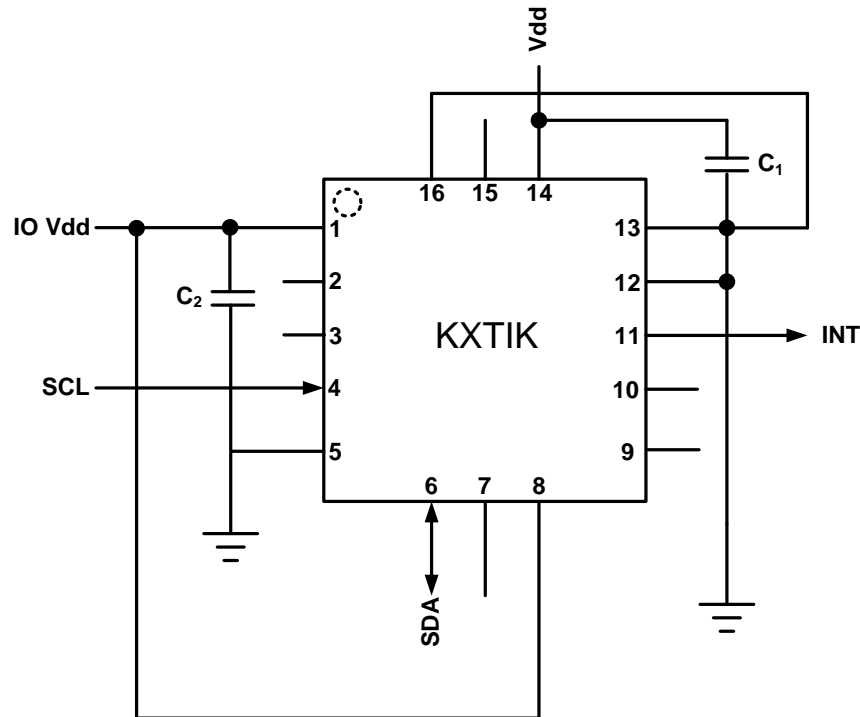

Table 4. KXTIK Pin Descriptions

Pin	Name	Description
1	IO Vdd	The power supply input for the digital communication bus. Optionally decouple this pin to ground with a 0.1uF ceramic capacitor.
2	RES	Reserved – Not Connected Internally
3	DNC	Reserved – Do Not Connect
4	SCL	I ² C Serial Clock
5	GND	Ground
6	SDA	I ² C Serial Data
7	NC	Not Internally Connected – Can be connected to Vdd, GND or Float
8	RES	Reserved – connect to IO Vdd
9	RES	Reserved – Internally connected to GND – Can be connected to GND or Float
10	RES	Reserved – Internally connected to GND – Can be connected to GND or Float
11	INT	Physical Interrupt
12	GND	Ground
13	RES	Reserved – Internally connected to GND – Can be connected to GND or Float
14	Vdd	The power supply input. Decouple this pin to ground with a 0.1uF ceramic capacitor.
15	NC	Not Internally Connected – Can be connected to Vdd, GND or Float
16	RES	Reserved – Internally connected to GND – Can be connected to GND or Float



± 2g / 4g / 8g Tri-axis Digital Accelerometer Specifications

PART NUMBER:

**KXTIK-1004
Rev. 2
Dec-2011**

Test Specifications



Special Characteristics:

These characteristics have been identified as being critical to the customer. Every part is tested to verify its conformance to specification prior to shipment.

Table 5. Test Specifications

Parameter	Specification	Test Conditions
Zero-g Offset @ RT	0 +/- 128 counts	25C, Vdd = 2.6 V
Sensitivity @ RT	1024 +/- 35.8 counts/g	25C, Vdd = 2.6 V



± 2g / 4g / 8g Tri-axis Digital Accelerometer Specifications

PART NUMBER:

KXTIK-1004
Rev. 2
Dec-2011

Package Dimensions and Orientation

3 x 3 x 0.9 mm LGA

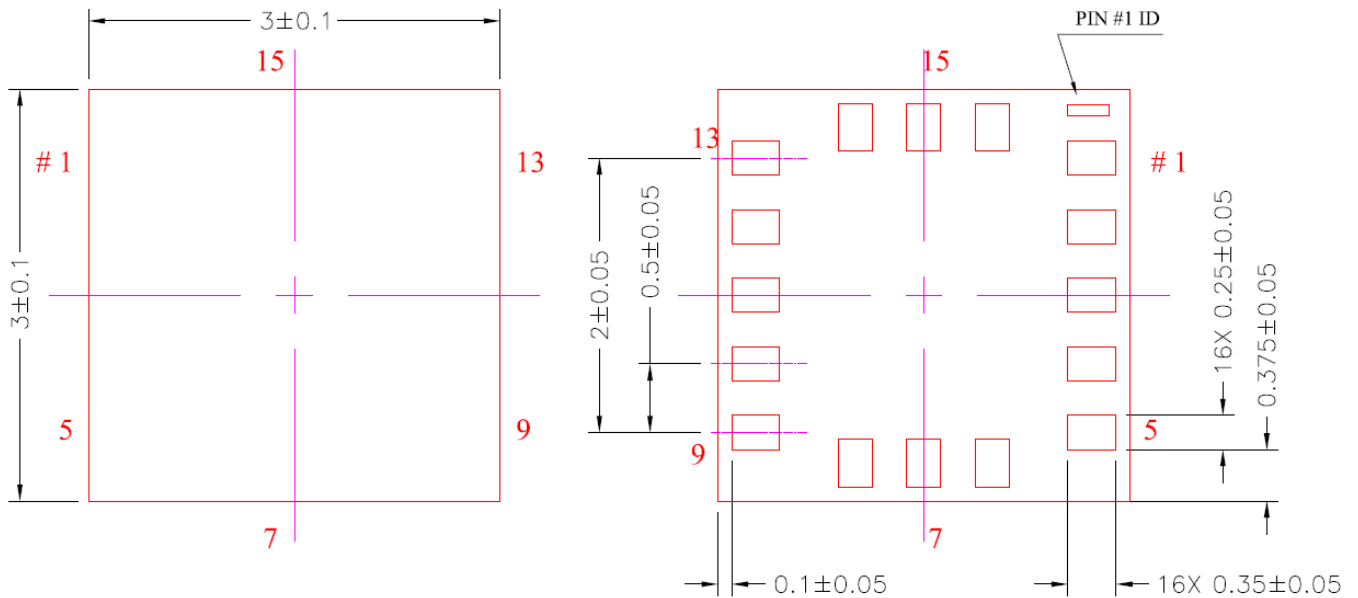

TOP VIEW

BOTTOM VIEW

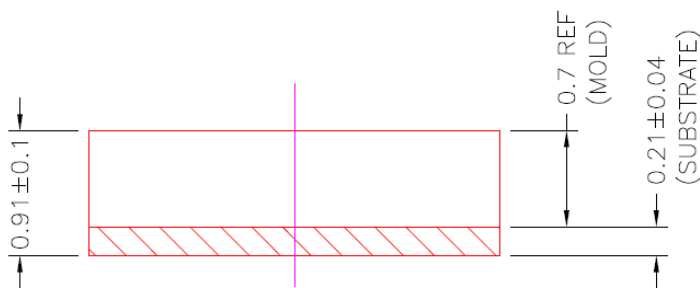

SIDE VIEW

All dimensions and tolerances conform to ASME Y14.5M-1994



± 2g / 4g / 8g Tri-axis Digital Accelerometer Specifications

PART NUMBER:

KXTIK-1004
Rev. 2
Dec-2011

Orientation

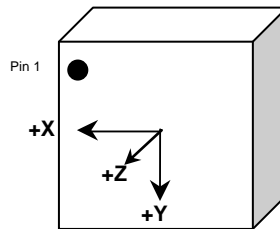

When device is accelerated in +X, +Y or +Z direction, the corresponding output will increase.

Static X/Y/Z Output Response versus Orientation to Earth's surface (1g): GSEL1=0, GSEL0=0 (± 2g)

Position	1		2		3		4		5		6	
Diagram									Top 		Bottom 	
Resolution (bits)	12	8	12	8	12	8	12	8	12	8	12	8
X (counts)	0	0	-1024	-64	0	0	1024	64	0	0	0	0
Y (counts)	-1024	-64	0	0	1024	64	0	0	0	0	0	0
Z (counts)	0	0	0	0	0	0	0	0	1024	64	-1024	-64
X-Polarity	0		-		0		+		0		0	
Y-Polarity	-		0		+		0		0		0	
Z-Polarity	0		0		0		0		+		-	

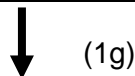

Earth's Surface



± 2g / 4g / 8g Tri-axis Digital Accelerometer Specifications

PART NUMBER:

KXTIK-1004
Rev. 2
Dec-2011

Static X/Y/Z Output Response versus Orientation to Earth's surface (1g): GSEL1=0, GSEL0=1 (± 4g)

Position	1		2		3		4		5		6	
Diagram									Top 		Bottom 	
Resolution (bits)	12	8	12	8	12	8	12	8	12	8	12	8
X (counts)	0	0	-512	-32	0	0	512	32	0	0	0	0
Y (counts)	-512	-32	0	0	512	32	0	0	0	0	0	0
Z (counts)	0	0	0	0	0	0	0	0	512	32	-512	-32
X-Polarity	0		-		0		+		0		0	
Y-Polarity	-		0		+		0		0		0	
Z-Polarity	0		0		0		0		+		-	

↓ (1g)

Earth's Surface

Static X/Y/Z Output Response versus Orientation to Earth's surface (1g): GSEL1=1, GSEL0=0 (± 8g)

Position	1		2		3		4		5		6	
Diagram									Top 		Bottom 	
Resolution (bits)	12	8	12	8	12	8	12	8	12	8	12	8
X (counts)	0	0	-256	-16	0	0	256	16	0	0	0	0
Y (counts)	-256	-16	0	0	256	16	0	0	0	0	0	0
Z (counts)	0	0	0	0	0	0	0	0	256	16	-256	-16
X-Polarity	0		-		0		+		0		0	
Y-Polarity	-		0		+		0		0		0	
Z-Polarity	0		0		0		0		+		-	

↓ (1g)

Earth's Surface

	± 2g / 4g / 8g Tri-axis Digital Accelerometer Specifications	PART NUMBER: KXTIK-1004 Rev. 2 Dec-2011
---	---	--

KXTIK Digital Interface

The Kionix KXTIK digital accelerometer has the ability to communicate on the I²C digital serial interface bus. This flexibility allows for easy system integration by eliminating analog-to-digital converter requirements and by providing direct communication with system micro-controllers. In doing so, all of the digital communication pins have shared responsibilities.

The serial interface terms and descriptions as indicated in Table 6 below will be observed throughout this document.

Term	Description
Transmitter	The device that transmits data to the bus.
Receiver	The device that receives data from the bus.
Master	The device that initiates a transfer, generates clock signals, and terminates a transfer.
Slave	The device addressed by the Master.

Table 6. Serial Interface Terminologies

I²C Serial Interface

As previously mentioned, the KXTIK has the ability to communicate on an I²C bus. I²C is primarily used for synchronous serial communication between a Master device and one or more Slave devices. The Master, typically a micro controller, provides the serial clock signal and addresses Slave devices on the bus. The KXTIK always operates as a Slave device during standard Master-Slave I²C operation.

I²C is a two-wire serial interface that contains a Serial Clock (SCL) line and a Serial Data (SDA) line. SCL is a serial clock that is provided by the Master, but can be held low by any Slave device, putting the Master into a wait condition. SDA is a bi-directional line used to transmit and receive data to and from the interface. Data is transmitted MSB (Most Significant Bit) first in 8-bit per byte format, and the number of bytes transmitted per transfer is unlimited. The I²C bus is considered free when both lines are high.

I²C Operation

Transactions on the I²C bus begin after the Master transmits a start condition (S), which is defined as a high-to-low transition on the data line while the SCL line is held high. The bus is considered busy after this condition. The next byte of data transmitted after the start condition contains the Slave Address (SAD) in the seven MSBs (Most Significant Bits), and the LSB (Least Significant Bit) tells whether the Master will be receiving data '1' from the Slave or transmitting data '0' to the Slave. When a Slave Address is sent, each device on the bus compares the seven MSBs with its internally stored address. If they match, the device considers itself addressed by the Master. The Slave Address associated with the KXTIK is 0001111.



± 2g / 4g / 8g Tri-axis Digital Accelerometer Specifications

PART NUMBER:

KXTIK-1004
Rev. 2
Dec-2011

It is mandatory that receiving devices acknowledge (ACK) each transaction. Therefore, the transmitter must release the SDA line during this ACK pulse. The receiver then pulls the data line low so that it remains stable low during the high period of the ACK clock pulse. A receiver that has been addressed, whether it is Master or Slave, is obliged to generate an ACK after each byte of data has been received. To conclude a transaction, the Master must transmit a stop condition (P) by transitioning the SDA line from low to high while SCL is high. The I²C bus is now free.

Writing to a KXTIK 8-bit Register

Upon power up, the Master must write to the KXTIK's control registers to set its operational mode. Therefore, when writing to a control register on the I²C bus, as shown Sequence 1 on the following page, the following protocol must be observed: After a start condition, SAD+W transmission, and the KXTIK ACK has been returned, an 8-bit Register Address (RA) command is transmitted by the Master. This command is telling the KXTIK to which 8-bit register the Master will be writing the data. Since this is I²C mode, the MSB of the RA command should always be zero (0). The KXTIK acknowledges the RA and the Master transmits the data to be stored in the 8-bit register. The KXTIK acknowledges that it has received the data and the Master transmits a stop condition (P) to end the data transfer. The data sent to the KXTIK is now stored in the appropriate register. The KXTIK automatically increments the received RA commands and, therefore, multiple bytes of data can be written to sequential registers after each Slave ACK as shown in Sequence 2 on the following page.

Reading from a KXTIK 8-bit Register

When reading data from a KXTIK 8-bit register on the I²C bus, as shown in Sequence 3 on the next page, the following protocol must be observed: The Master first transmits a start condition (S) and the appropriate Slave Address (SAD) with the LSB set at '0' to write. The KXTIK acknowledges and the Master transmits the 8-bit RA of the register it wants to read. The KXTIK again acknowledges, and the Master transmits a repeated start condition (Sr). After the repeated start condition, the Master addresses the KXTIK with a '1' in the LSB (SAD+R) to read from the previously selected register. The Slave then acknowledges and transmits the data from the requested register. The Master does not acknowledge (NACK) it received the transmitted data, but transmits a stop condition to end the data transfer. Note that the KXTIK automatically increments through its sequential registers, allowing data to be read from multiple registers following a single SAD+R command as shown below in Sequence 4 on the following page.

If a receiver cannot transmit or receive another complete byte of data until it has performed some other function, it can hold SCL low to force the transmitter into a wait state. Data transfer only continues when the receiver is ready for another byte and releases SCL.



± 2g / 4g / 8g Tri-axis Digital Accelerometer Specifications

PART NUMBER:

**KXTIK-1004
Rev. 2
Dec-2011**

Data Transfer Sequences

The following information clearly illustrates the variety of data transfers that can occur on the I²C bus and how the Master and Slave interact during these transfers. Table 7 defines the I²C terms used during the data transfers.

Term	Definition
S	Start Condition
Sr	Repeated Start Condition
SAD	Slave Address
W	Write Bit
R	Read Bit
ACK	Acknowledge
NACK	Not Acknowledge
RA	Register Address
Data	Transmitted/Received Data
P	Stop Condition

Table 7. I²C Terms

Sequence 1. The Master is writing one byte to the Slave.

Master	S	SAD + W		RA		DATA		P
Slave			ACK		ACK		ACK	

Sequence 2. The Master is writing multiple bytes to the Slave.

Master	S	SAD + W		RA		DATA		DATA		P
Slave			ACK		ACK		ACK		ACK	

Sequence 3. The Master is receiving one byte of data from the Slave.

Master	S	SAD + W		RA		Sr	SAD + R			NACK	P
Slave			ACK		ACK			ACK	DATA		

Sequence 4. The Master is receiving multiple bytes of data from the Slave.

Master	S	SAD + W		RA		Sr	SAD + R			ACK		NACK	P
Slave			ACK		ACK			ACK	DATA		DATA		



± 2g / 4g / 8g Tri-axis Digital Accelerometer Specifications

PART NUMBER:

**KXTIK-1004
Rev. 2
Dec-2011**

KXTIK Embedded Registers

The KXTIK has 44 embedded 8-bit registers that are accessible by the user. This section contains the addresses for all embedded registers and also describes bit functions of each register. Table 8 below provides a listing of the accessible 8-bit registers and their addresses.

Register Name	Type Read/Write	I2C Address	
		Hex	Binary
XOUT_HPF_L	R	0x00	0000 0000
XOUT_HPF_H	R	0x01	0000 0001
YOUT_HPF_L	R	0x02	0000 0010
YOUT_HPF_H	R	0x03	0000 0011
ZOUT_HPF_L	R	0x04	0000 0100
ZOUT_HPF_H	R	0x05	0000 0101
XOUT_L	R	0x06	0000 0110
XOUT_H	R	0x07	0000 0111
YOUT_L	R	0x08	0000 1000
YOUT_H	R	0x09	0000 1001
ZOUT_L	R	0x0A	0000 1010
ZOUT_H	R	0x0B	0000 1011
DCST_RESP	R	0x0C	0000 1100
Not Used	-	0x0D	0000 1101
Not Used	-	0x0E	0000 1110
WHO_AM_I	R	0x0F	0000 1111
TILT_POS_CUR	R	0x10	0001 0000
TILT_POS_PRE	R	0x11	0001 0001
Kionix Reserved	-	0x12	0001 0010
Kionix Reserved	-	0x13	0001 0011
Kionix Reserved	-	0x14	0001 0100
INT_SRC_REG1	R	0x15	0001 0101
INT_SRC_REG2	R	0x16	0001 0110
Not Used	-	0x17	0001 0111
STATUS_REG	R	0x18	0001 1000
Not Used	-	0x19	0001 1001
INT_REL	R	0x1A	0001 1010
CTRL_REG1*	R/W	0x1B	0001 1011
CTRL_REG2*	R/W	0x1C	0001 1100



± 2g / 4g / 8g Tri-axis Digital Accelerometer Specifications

PART NUMBER:

**KXTIK-1004
Rev. 2
Dec-2011**

CTRL_REG3*	R/W	0x1D	0001 1101
INT_CTRL_REG1*	R/W	0x1E	0001 1110
INT_CTRL_REG2*	R/W	0x1F	0001 1111
INT_CTRL_REG3*	R/W	0x20	0010 0000
DATA_CTRL_REG*	R/W	0x21	0010 0001
Not Used	-	0x22 – 0x27	-
TILT_TIMER*	R/W	0x28	0010 1000
WUF_TIMER*	R/W	0x29	0010 1001
Not Used	-	0x2A	0010 1010
TDT_TIMER*	R/W	0x2B	0010 1011
TDT_H_THRESH*	R/W	0x2C	0010 1100
TDT_L_THRESH*	R/W	0x2D	0010 1101
TDT_TAP_TIMER*	R/W	0x2E	0010 1110
TDT_TOTAL_TIMER*	R/W	0x2F	0010 1111
TDT_LATENCY_TIMER*	R/W	0x30	0011 0000
TDT_WINDOW_TIMER*	R/W	0x31	0011 0001
BUF_CTRL1*	R/W	0x32	0011 0010
BUF_CTRL2*	R/W	0x33	0011 0011
BUF_STATUS_REG1	R	0x34	0011 0100
BUF_STATUS_REG2	R	0x35	0011 0101
BUF_CLEAR	W	0x36	0011 0110
Reserved	-	0x37 – 0x39	-
SELF_TEST	R/W	0x3A	0011 1010
Reserved	-	0x3B – 0x59	-
WUF_THRESH*	R/W	0x5A	0101 1010
Reserved	-	0x5B	0101 1011
TILT_ANGLE*	R/W	0x5C	0101 1100
Reserved	-	0x5D – 0x5E	-
HYST_SET*	R/W	0x5F	0101 1111
BUF_READ	R	0x7F	0111 1111

* Note: When changing the contents of these registers, the PC1 bit in CTRL_REG1 must first be set to “0”.

Table 8. KXTIK Register Map



± 2g / 4g / 8g Tri-axis Digital Accelerometer Specifications

PART NUMBER:

**KXTIK-1004
Rev. 2
Dec-2011**

KXTIK Register Descriptions

Accelerometer Outputs

These registers contain up to 12-bits of valid acceleration data for each axis depending on the setting of the RES bit in CTRL_REG1, where the acceleration outputs are represented in 12-bit valid data when RES = '1' and 8-bit valid data when RES = '0'. The data is updated every user-defined ODR period, is protected from overwrite during each read, and can be converted from digital counts to acceleration (g) per Figure 1 below. The register acceleration output binary data is represented in N-bit 2's complement format. For example, if N = 12 bits, then the Counts range is from -2048 to 2047, and if N = 8 bits, then the Counts range is from -128 to 127.

12-bit Register Data (2's complement)	Equivalent Counts in decimal	Range = +/-2g	Range = +/-4g	Range = +/-8g
0111 1111 1111	2047	+1.999g	+3.998g	+7.996g
0111 1111 1110	2046	+1.998g	+3.996g	+7.992g
...
0000 0000 0001	1	+0.001g	+0.002g	+0.004g
0000 0000 0000	0	0.000g	0.000g	0.000g
1111 1111 1111	-1	-0.001g	-0.002g	-0.004g
...
1000 0000 0001	-2047	-1.999g	-3.998g	-7.996g
1000 0000 0000	-2048	-2.000g	-4.000g	-8.000g

8-bit Register Data (2's complement)	Equivalent Counts in decimal	Range = +/-2g	Range = +/-4g	Range = +/-8g
0111 1111	127	+1.984g	+3.968g	+7.936g
0111 1110	126	+1.968g	+3.936g	+7.872g
...
0000 0001	1	+0.016g	+0.032g	+0.064g
0000 0000	0	0.000g	0.000g	0.000g
1111 1111	-1	-0.016g	-0.032g	-0.064g
...
1000 0001	-127	-1.984g	-3.968g	-7.936g
1000 0000	-128	-2.000g	-4.000g	-8.000g

Figure 1. Acceleration (g) Calculation



± 2g / 4g / 8g Tri-axis Digital Accelerometer Specifications

PART NUMBER:

**KXTIK-1004
Rev. 2
Dec-2011**

Note: The High Pass Filter outputs are only available if the Wake Up Function is enabled.

XOUT_HPF_L

X-axis high-pass filtered accelerometer output least significant byte

R	R	R	R	R	R	R	R
XOUTD3	XOUTD2	XOUTD1	XOUTD0	X	X	X	X
Bit7	Bit6	Bit5	Bit4	Bit3	Bit2	Bit1	Bit0
					I ² C Address: 0x00h		

XOUT_HPF_H

X-axis high-pass filtered accelerometer output most significant byte

R	R	R	R	R	R	R	R
XOUTD11	XOUTD10	XOUTD9	XOUTD8	XOUTD7	XOUTD6	XOUTD5	XOUTD4
Bit7	Bit6	Bit5	Bit4	Bit3	Bit2	Bit1	Bit0
					I ² C Address: 0x01h		

YOUT_HPF_L

Y-axis high-pass filtered accelerometer output least significant byte

R	R	R	R	R	R	R	R
YOUTD3	YOUTD2	YOUTD1	YOUTD0	X	X	X	X
Bit7	Bit6	Bit5	Bit4	Bit3	Bit2	Bit1	Bit0
					I ² C Address: 0x02h		

YOUT_HPF_H

Y-axis high-pass filtered accelerometer output most significant byte

R	R	R	R	R	R	R	R
YOUTD11	YOUTD10	YOUTD9	YOUTD8	YOUTD7	YOUTD6	YOUTD5	YOUTD4
Bit7	Bit6	Bit5	Bit4	Bit3	Bit2	Bit1	Bit0
					I ² C Address: 0x03h		



± 2g / 4g / 8g Tri-axis Digital Accelerometer Specifications

PART NUMBER:

**KXTIK-1004
Rev. 2
Dec-2011**

ZOUT_HPF_L

Z-axis high-pass filtered accelerometer output least significant byte

R	R	R	R	R	R	R	R
ZOUTD3	ZOUTD2	ZOUTD1	ZOUTD0	X	X	X	X
Bit7	Bit6	Bit5	Bit4	Bit3	Bit2	Bit1	Bit0
I ² C Address: 0x04h							

ZOUT_HPF_H

Z-axis high-pass filtered accelerometer output most significant byte

R	R	R	R	R	R	R	R
ZOUTD11	ZOUTD10	ZOUTD9	ZOUTD8	ZOUTD7	ZOUTD6	ZOUTD5	ZOUTD4
Bit7	Bit6	Bit5	Bit4	Bit3	Bit2	Bit1	Bit0
I ² C Address: 0x05h							

XOUT_L

X-axis accelerometer output least significant byte

R	R	R	R	R	R	R	R
XOUTD3	XOUTD2	XOUTD1	XOUTD0	X	X	X	X
Bit7	Bit6	Bit5	Bit4	Bit3	Bit2	Bit1	Bit0
I ² C Address: 0x06h							

XOUT_H

X-axis accelerometer output most significant byte

R	R	R	R	R	R	R	R
XOUTD11	XOUTD10	XOUTD9	XOUTD8	XOUTD7	XOUTD6	XOUTD5	XOUTD4
Bit7	Bit6	Bit5	Bit4	Bit3	Bit2	Bit1	Bit0
I ² C Address: 0x07h							



± 2g / 4g / 8g Tri-axis Digital Accelerometer Specifications

PART NUMBER:

**KXTIK-1004
Rev. 2
Dec-2011**

YOUT_L

Y-axis accelerometer output least significant byte

R	R	R	R	R	R	R	R
YOUTD3	YOUTD2	YOUTD1	YOUTD0	X	X	X	X
Bit7	Bit6	Bit5	Bit4	Bit3	Bit2	Bit1	Bit0
I ² C Address: 0x08h							

YOUT_H

Y-axis accelerometer output most significant byte

R	R	R	R	R	R	R	R
YOUTD11	YOUTD10	YOUTD9	YOUTD8	YOUTD7	YOUTD6	YOUTD5	YOUTD4
Bit7	Bit6	Bit5	Bit4	Bit3	Bit2	Bit1	Bit0
I ² C Address: 0x09h							

ZOUT_L

Z-axis accelerometer output least significant byte

R	R	R	R	R	R	R	R
ZOUTD3	ZOUTD2	ZOUTD1	ZOUTD0	X	X	X	X
Bit7	Bit6	Bit5	Bit4	Bit3	Bit2	Bit1	Bit0
I ² C Address: 0x0Ah							

ZOUT_H

Z-axis accelerometer output most significant byte

R	R	R	R	R	R	R	R
ZOUTD11	ZOUTD10	ZOUTD9	ZOUTD8	ZOUTD7	ZOUTD6	ZOUTD5	ZOUTD4
Bit7	Bit6	Bit5	Bit4	Bit3	Bit2	Bit1	Bit0
I ² C Address: 0x0Bh							



± 2g / 4g / 8g Tri-axis Digital Accelerometer Specifications

PART NUMBER:

**KXTIK-1004
Rev. 2
Dec-2011**

DCST_RESP

This register can be used to verify proper integrated circuit functionality. It always has a byte value of 0x55h unless the DCST bit in CTRL_REG3 is set. At that point this value is set to 0xAAh. The byte value is returned to 0x55h after reading this register.

R	R	R	R	R	R	R	R	
DCSTR7	DCSTR6	DCSTR5	DCSTR4	DCSTR3	DCSTR2	DCSTR1	DCSTR0	Reset Value
Bit7	Bit6	Bit5	Bit4	Bit3	Bit2	Bit1	Bit0	01010101
I ² C Address: 0x0Ch								

WHO_AM_I

This register can be used for supplier recognition, as it can be factory written to a known byte value. The default value is 0x05h.

R	R	R	R	R	R	R	R	
WIA7	WIA6	WIA5	WIA4	WIA3	WIA2	WIA1	WIA0	Reset Value
Bit7	Bit6	Bit5	Bit4	Bit3	Bit2	Bit1	Bit0	00000101
I ² C Address: 0x0Fh								

Tilt Position Registers

These two registers report previous and current tilt position data that is updated at the user-defined ODR frequency and is protected during register read. Table 9 describes the reported position for each bit value.

TILT_POS_CUR

Current tilt position register

R	R	R	R	R	R	R	R	
0	0	LE	RI	DO	UP	FD	FU	Reset Value
Bit7	Bit6	Bit5	Bit4	Bit3	Bit2	Bit1	Bit0	00100000
I ² C Address: 0x10h								

TILT_POS_PRE

Previous tilt position register

R	R	R	R	R	R	R	R	
0	0	LE	RI	DO	UP	FD	FU	Reset Value
Bit7	Bit6	Bit5	Bit4	Bit3	Bit2	Bit1	Bit0	00100000
I ² C Address: 0x11h								



± 2g / 4g / 8g Tri-axis Digital Accelerometer Specifications

PART NUMBER:

**KXTIK-1004
Rev. 2
Dec-2011**

Bit	Description
LE	Left State (X-)
RI	Right State (X+)
DO	Down State (Y-)
UP	Up State (Y+)
FD	Face-Down State (Z-)
FU	Face-Up State (Z+)

Table 9. KXTIK Tilt Position

Interrupt Source Registers

These two registers report function state changes. This data is updated when a new state change or event occurs and each application's result is latched until the interrupt release register is read. The motion interrupt bit WUFS can be configured to report data in an unlatched manner via the interrupt control registers.

INT_SRC_REG1

This register reports which axis and direction detected a single or double tap event, per Table 10.

R	R	R	R	R	R	R	R
0	0	TLE	TRI	TDO	TUP	TFD	TFU
Bit7	Bit6	Bit5	Bit4	Bit3	Bit2	Bit1	Bit0
I ² C Address: 0x15h							

Bit	Description
TLE	X Negative (X-) Reported
TRI	X Positive (X+) Reported
TDO	Y Negative (Y-) Reported
TUP	Y Positive (Y+) Reported
TFD	Z Negative (Z-) Reported
TFU	Z Positive (Z+) Reported

Table 10. KXTIK Directional Tap™ Reporting



± 2g / 4g / 8g Tri-axis Digital Accelerometer Specifications

PART NUMBER:

**KXTIK-1004
Rev. 2
Dec-2011**

INT_SRC_REG2

This register reports which function caused an interrupt. Reading from the interrupt release register will clear the entire contents of this register.

R	R	R	R	R	R	R	R
0	0	WMI	DRDY	TDTS1	TDTS0	WUFS	TPS
Bit7	Bit6	Bit5	Bit4	Bit3	Bit2	Bit1	Bit0
I ² C Address: 0x16h							

DRDY indicates that new acceleration data is available. This bit is cleared when acceleration data is read or the interrupt release register is read.

DRDY = 0 – new acceleration data not available

DRDY = 1 – new acceleration data available

TDTS1, TDTS0 indicates whether a single or double-tap event was detected per Table 11.

TDTS1	TDTS0	Event
0	0	No Tap
0	1	Single Tap
1	0	Double Tap
1	1	DNE

Table 11. Directional Tap™ Event Description

TPS reflects the status of the tilt position function.

TPS = 0 – tilt position state has not changed

TPS = 1 – tilt position state has changed

WMI indicates that the buffer's sample threshold has been exceeded when in FIFO, FILO, or Stream mode. Not used in Trigger mode.

WMI = 0 – sample threshold has not been exceeded

WMI = 1 – sample threshold has been exceeded

STATUS_REG

This register reports the status of the interrupt.

R	R	R	R	R	R	R	R
0	0	0	INT	0	0	0	0
Bit7	Bit6	Bit5	Bit4	Bit3	Bit2	Bit1	Bit0
I ² C Address: 0x18h							



± 2g / 4g / 8g Tri-axis Digital Accelerometer Specifications

PART NUMBER:

**KXTIK-1004
Rev. 2
Dec-2011**

INT reports the combined interrupt information of all enabled functions. This bit is released to 0 when the interrupt source latch register (1Ah) is read.

INT = 0 – no interrupt event

INT = 1 – interrupt event has occurred

INT_REL

Latched interrupt source information (INT_SRC_REG1 and INT_SRC_REG2), the status register, and the physical interrupt pin (11) are cleared when reading this register.

R	R	R	R	R	R	R	R
X	X	X	X	X	X	X	X
Bit7	Bit6	Bit5	Bit4	Bit3	Bit2	Bit1	Bit0
I ² C Address: 0x1Ah							

CTRL_REG1

Read/write control register that controls the main feature set.

R/W	R/W	R/W	R/W	R/W	R/W	R/W	R/W	
PC1	RES	DRDYE	GSEL1	GSEL0	TDTE	WUFE	TPE	Reset Value
Bit7	Bit6	Bit5	Bit4	Bit3	Bit2	Bit1	Bit0	00000000
I ² C Address: 0x1Bh								

PC1 controls the operating mode of the KXTIK.

PC1 = 0 - stand-by mode

PC1 = 1 – operating mode

RES determines the performance mode of the KXTIK. Note that to change the value of this bit, the PC1 bit must first be set to “0”.

RES = 0 – low current, 8-bit valid

RES = 1- high current, 12-bit valid

DRDYE enables the reporting of the availability of new acceleration data on the interrupt. Note that to change the value of this bit, the PC1 bit must first be set to “0”.

DRDYE = 0 – availability of new acceleration data not reflected on interrupt pin (11)

DRDYE = 1- availability of new acceleration data reflected on interrupt pin (11)

GSEL1, GSEL0 selects the acceleration range of the accelerometer outputs per Table 12. Note that to change the value of this bit, the PC1 bit must first be set to “0”.



± 2g / 4g / 8g Tri-axis Digital Accelerometer Specifications

PART NUMBER:

KXTIK-1004
Rev. 2
Dec-2011

GSEL1	GSEL0	Range
0	0	+/-2g
0	1	+/-4g
1	0	+/-8g
1	1	NA

Table 12. Selected Acceleration Range

TDTE enables the Directional Tap™ function that will detect single and double tap events. Note that to change the value of this bit, the PC1 bit must first be set to “0”.

TDTE = 0 – disable
TDTE = 1- enable

WUFE enables the Wake Up (motion detect) function that will detect a general motion event. Note that to change the value of this bit, the PC1 bit must first be set to “0”.

WUFE = 0 – disable
WUFE = 1- enable

TPE enables the Tilt Position function that will detect changes in device orientation. Note that to change the value of this bit, the PC1 bit must first be set to “0”.

TPE = 0 – disable
TPE = 1- enable

CTRL_REG2

Read/write control register that primarily controls tilt position state enabling. Per Table 13, if a state’s bit is set to one (1), a transition into the corresponding orientation state will generate an interrupt. If it is set to zero (0), a transition into the corresponding orientation state will not generate an interrupt. Note that to properly change the value of this register, the PC1 bit in CTRL_REG1 must first be set to “0”.

R/W	R/W	R/W	R/W	R/W	R/W	R/W	R/W	Reset Value
OTDTH	0	LEM	RIM	DOM	UPM	FDM	FUM	00111111
Bit7	Bit6	Bit5	Bit4	Bit3	Bit2	Bit1	Bit0	
I ² C Address: 0x1Ch								



± 2g / 4g / 8g Tri-axis Digital Accelerometer Specifications

PART NUMBER:

KXTIK-1004
Rev. 2
Dec-2011

OTDTH determines the range of the Directional Tap™ Output Data Rate (ODR). See Table 15 for additional clarification.

OTDTH = 0 – slower range of Directional Tap™ ODR's are available.

OTDTH = 1 – faster range of Directional Tap™ ODR's are available.

Bit	Description
LEM	Left State
RIM	Right State
DOM	Down State
UPM	Up State
FDM	Face-Down State
FUM	Face-Up State

Table 13. Tilt Position State Enabling

CTRL_REG3

Read/write control register that provides more feature set control. Note that to properly change the value of this register, the PC1 bit in CTRL_REG1 must first be set to "0".

R/W	R/W	R/W	R/W	R/W	R/W	R/W	R/W	
SRST	OTPA	OTPB	DCST	OTDTA	OTDTB	OWUFA	OWUFB	Reset Value
Bit7	Bit6	Bit5	Bit4	Bit3	Bit2	Bit1	Bit0	01001101
I ² C Address: 0x1Dh								

SRST initiates software reset, which performs the RAM reboot routine. This bit will remain 1 until the RAM reboot routine is finished.

SRST = 0 – no action

SRST = 1 – start RAM reboot routine

Note for I2C Communication: Setting SRST = 1 will NOT result in an ACK, since the part immediately enters the RAM reboot routine. NACK may be used to confirm this command.

OTPA, OTPB sets the output data rate for the Tilt Position function per Table 14. The default Tilt Position ODR is 12.5Hz.



± 2g / 4g / 8g Tri-axis Digital Accelerometer Specifications

PART NUMBER:

**KXTIK-1004
Rev. 2
Dec-2011**

OTPA	OTPB	Output Data Rate
0	0	1.6Hz
0	1	6.3Hz
1	0	12.5Hz
1	1	50Hz

Table 14. Tilt Position Function Output Data Rate

DCST initiates the digital communication self-test function.

DCST = 0 – no action

DCST = 1 – sets ST_RESP register to 0xAAh and when ST_RESP is read, sets this bit to 0 and sets ST_RESP to 0x55h

OTDTA, OTDTB sets the output data rate for the Directional Tap™ function per Table 15. The default Directional Tap™ ODR is 400Hz.

OTDTH	OTDTA	OTDTB	Output Data Rate
0	0	0	50Hz
0	0	1	100Hz
0	1	0	200Hz
0	1	1	400Hz
1	0	0	12.5Hz
1	0	1	25Hz
1	1	0	800Hz
1	1	1	1600Hz

Table 15. Directional Tap™ Function Output Data Rate

OWUFA, OWUFB sets the output data rate for the general motion detection function and the high-pass filtered outputs per Table 16. The default Motion Wake Up ODR is 50Hz.



± 2g / 4g / 8g Tri-axis Digital Accelerometer Specifications

PART NUMBER:

**KXTIK-1004
Rev. 2
Dec-2011**

OWUFA	OWUFB	Output Data Rate
0	0	25Hz
0	1	50Hz
1	0	100Hz
1	1	200Hz

Table 16. Motion Wake Up Function Output Data Rate

INT_CTRL_REG1

This register controls the settings for the physical interrupt pin (11). Note that to properly change the value of this register, the PC1 bit in CTRL_REG1 must first be set to “0”.

R/W	R/W	R/W	R/W	R/W	R/W	R/W	R/W	
0	0	IEN	IEA	IEL	IEU	0	0	Reset Value
Bit7	Bit6	Bit5	Bit4	Bit3	Bit2	Bit1	Bit0	00010000
I ² C Address: 0x1Eh								

IEN enables/disables the physical interrupt pin (11)

IEN = 0 – physical interrupt pin (11) is disabled

IEN = 1 – physical interrupt pin (11) is enabled

IEA sets the polarity of the physical interrupt pin (11)

IEA = 0 – polarity of the physical interrupt pin (11) is active low

IEA = 1 – polarity of the physical interrupt pin (11) is active high

IEL sets the response of the physical interrupt pin (11)

IEL = 0 – the physical interrupt pin (11) latches until it is cleared by reading INT_REL

IEL = 1 – the physical interrupt pin (11) will transmit one pulse with a period of approximately 0.03 - 0.05ms

IEU sets an alternate unlatched response for the physical interrupt pin (11) when the motion interrupt feature (WUF) only is enabled.

IEU = 0 – the physical interrupt pin (11) latches or pulses per the IEL bit until it is cleared by reading INT_REL

IEU = 1 – the physical interrupt pin (11) will follow an unlatched response if the motion interrupt feature is enabled



± 2g / 4g / 8g Tri-axis Digital Accelerometer Specifications

PART NUMBER:

**KXTIK-1004
Rev. 2
Dec-2011**

INT_CTRL_REG2

This register controls motion detection axis enabling. Per Table 17, if an axis' bit is set to one (1), a motion on that axis will generate an interrupt. If it is set to zero (0), a motion on that axis will not generate an interrupt. Note that to properly change the value of this register, the PC1 bit in CTRL_REG1 must first be set to "0".

R/W	R/W	R/W	R/W	R/W	R/W	R/W	R/W	
XBW	YBW	ZBW	0	0	0	0	0	Reset Value
Bit7	Bit6	Bit5	Bit4	Bit3	Bit2	Bit1	Bit0	11100000
								I ² C Address: 0x1Fh

Bit	Description
XBW	X-Axis Motion
YBW	Y-Axis Motion
ZBW	Z-Axis Motion

Table 17. Motion Detection Axis Enabling

INT_CTRL_REG3

This register controls the tap detection direction axis enabling. Per Table 18, if a direction's bit is set to one (1), a single or double tap in that direction will generate an interrupt. If it is set to zero (0), a single or double tap in that direction will not generate an interrupt. Note that to properly change the value of this register, the PC1 bit in CTRL_REG1 must first be set to "0".

R/W	R/W	R/W	R/W	R/W	R/W	R/W	R/W	
0	TMEN	TLEM	TRIM	TDOM	TUPM	TFDM	TFUM	Reset Value
Bit7	Bit6	Bit5	Bit4	Bit3	Bit2	Bit1	Bit0	00111111
								I ² C Address: 0x20h

Bit	Description
TLEM	X Negative (X-)
TRIM	X Positive (X+)
TDOM	Y Negative (Y-)
TUPM	Y Positive (Y+)
TFDM	Z Negative (Z-)
TFUM	Z Positive (Z+)

Table 18. Directional Tap™ Axis Mask

***TMEN** enables/disables alternate tap masking scheme*



± 2g / 4g / 8g Tri-axis Digital Accelerometer Specifications

PART NUMBER:

**KXTIK-1004
Rev. 2
Dec-2011**

*TMEN = 0 – alternate tap masking scheme disabled
TMEN = 1 – alternate tap masking scheme enabled*

DATA_CTRL_REG

Read/write control register that configures the acceleration outputs. Note that to properly change the value of this register, the PC1 bit in CTRL_REG1 must first be set to “0”.

R/W	R/W	R/W	R/W	R/W	R/W	R/W	R/W	
0	0	HPFROA	HPROB	0	OSAA	OSAB	OSAC	Reset Value
Bit7	Bit6	Bit5	Bit4	Bit3	Bit2	Bit1	Bit0	00000010
								I ² C Address: 0x21h

HPFROA, HPFROB sets the roll-off frequency for the first-order high-pass filter in conjunction with the output data rate (OWUFA, OWUFB) that is chosen for the HPF acceleration outputs that are used in the Motion Wake Up (WUF) application per Table 19. Note that this roll-off frequency is also applied to the X, Y and Z high-pass filtered outputs.

High-Pass Filter Configuration			
HPFROA	HPFROB	Beta	HPF Roll-Off (Hz)
0	0	7/8	ODR / 50
0	1	15/16	ODR / 100
1	0	31/32	ODR / 200
1	1	63/64	ODR / 400

Table 19. High-Pass Filter Roll-Off Frequency

OSAA, OSAB, OSAC sets the output data rate (ODR) for the low-pass filtered acceleration outputs per Table 20.



± 2g / 4g / 8g Tri-axis Digital Accelerometer Specifications

PART NUMBER:

**KXTIK-1004
Rev. 2
Dec-2011**

OSAA	OSAB	OSAC	Output Data Rate	LPF Roll-Off
0	0	0	12.5Hz	6.25Hz
0	0	1	25Hz	12.5Hz
0	1	0	50Hz	25Hz
0	1	1	100Hz	50Hz
1	0	0	200Hz	100Hz
1	0	1	400Hz	200Hz
1	1	0	800Hz	400Hz
1	1	1	Does Not Exist	Does Not Exist

Table 20. LPF Acceleration Output Data Rate (ODR)

TILT_TIMER

This register is the initial count register for the tilt position state timer (0 to 255 counts). Every count is calculated as 1/ODR delay period, where the Tilt Position ODR is user-defined per Table 14. A new state must be valid as many measurement periods before the change is accepted. Note that to properly change the value of this register, the PC1 bit in CTRL_REG1 must first be set to “0”.

R/W	R/W	R/W	R/W	R/W	R/W	R/W	R/W	
TSC7	TSC6	TSC5	TSC4	TSC3	TSC2	TSC1	TSC0	Reset Value
Bit7	Bit6	Bit5	Bit4	Bit3	Bit2	Bit1	Bit0	00000000
I ² C Address: 0x28h								

WUF_TIMER

This register is the initial count register for the motion detection timer (0 to 255 counts). Every count is calculated as 1/ODR delay period, where the Motion Wake Up ODR is user-defined per Table 16. A new state must be valid as many measurement periods before the change is accepted. Note that to properly change the value of this register, the PC1 bit in CTRL_REG1 must first be set to “0”.

R/W	R/W	R/W	R/W	R/W	R/W	R/W	R/W	
WUFC7	WUFC6	WUFC5	WUFC4	WUFC3	WUFC2	WUFC1	WUFC0	Reset Value
Bit7	Bit6	Bit5	Bit4	Bit3	Bit2	Bit1	Bit0	00000000
I ² C Address: 0x29h								

TDT_TIMER

This register contains counter information for the detection of a double tap event. When the Directional Tap™ ODR is 400Hz or less, every count is calculated as 1/ODR delay period. When the Directional Tap™ ODR is 800Hz, every count is calculated as 2/ODR delay period. When the Directional Tap™ ODR is 1600Hz, every count is calculated as 4/ODR delay period. The Directional Tap™ ODR is user-



± 2g / 4g / 8g Tri-axis Digital Accelerometer Specifications

PART NUMBER:

**KXTIK-1004
Rev. 2
Dec-2011**

defined per Table 15. TDT_TIMER represents the minimum time separation between the first tap and the second tap in a double tap event. The Kionix recommended default value is 0.3 seconds (0x78h). Note that to properly change the value of this register, the PC1 bit in CTRL_REG1 must first be set to "0".

R/W	R/W	R/W	R/W	R/W	R/W	R/W	R/W	
TDTC7	TDTC6	TDTC5	TDTC4	TDTC3	TDTC2	TDTC1	TDTC0	Reset Value
Bit7	Bit6	Bit5	Bit4	Bit3	Bit2	Bit1	Bit0	01111000
								I ² C Address: 0x2Bh

TDT_H_THRESH

This register represents the 8-bit jerk high threshold to determine if a tap is detected. Though this is an 8-bit register, the KXTIK internally multiplies the register value by two in order to set the high threshold. This multiplication results in a range of 0d to 510d with a resolution of two counts. The Performance Index (PI) is the jerk signal that is expected to be less than this threshold, but greater than the TDT_L_THRESH threshold during single and double tap events. Note that to properly change the value of this register, the PC1 bit in CTRL_REG1 must first be set to "0". The Kionix recommended default value is 203 (0xCBh) and the Performance Index is calculated as:

$$\begin{aligned}
 X' &= X(\text{current}) - X(\text{previous}) \\
 Y' &= Y(\text{current}) - Y(\text{previous}) \\
 Z' &= Z(\text{current}) - Z(\text{previous})
 \end{aligned}$$

$$PI = |X'| + |Y'| + |Z'|$$

Equation 1. Performance Index

R/W	R/W	R/W	R/W	R/W	R/W	R/W	R/W	
TTH7	TTH6	TTH5	TTH4	TTH3	TTH2	TTH1	TTH0	Reset Value
Bit7	Bit6	Bit5	Bit4	Bit3	Bit2	Bit1	Bit0	11001011
								I ² C Address: 0x2Ch



± 2g / 4g / 8g Tri-axis Digital Accelerometer Specifications

PART NUMBER:

**KXTIK-1004
Rev. 2
Dec-2011**

TDT_L_THRESH

This register represents the 8-bit (0d– 255d) jerk low threshold to determine if a tap is detected. The Performance Index (PI) is the jerk signal that is expected to be greater than this threshold and less than the TDT_H_THRESH threshold during single and double tap events. This register also contains the LSB of the TDT_H_THRESH threshold. The Kionix recommended default value is 26 (0x1Ah). Note that to properly change the value of this register, the PC1 bit in CTRL_REG1 must first be set to “0”.

R/W	R/W	R/W	R/W	R/W	R/W	R/W	R/W	
TTH7	TTL6	TTL5	TTL4	TTL3	TTL2	TTL1	TTL0	Reset Value
Bit7	Bit6	Bit5	Bit4	Bit3	Bit2	Bit1	Bit0	00011010
								I ² C Address: 0x2Dh

TDT_TAP_TIMER

This register contains counter information for the detection of any tap event. When the Directional Tap™ ODR is 400Hz or less, every count is calculated as 1/ODR delay period. When the Directional Tap™ ODR is 800Hz, every count is calculated as 2/ODR delay period. When the Directional Tap™ ODR is 1600Hz, every count is calculated as 4/ODR delay period. The Directional Tap™ ODR is user-defined per Table 15. In order to ensure that only tap events are detected, these time limits are used. A tap event must be above the performance index threshold (TDT_THRESH) for at least the low limit (FTDL0 – FTDL2) and no more than the high limit (FTDH0 – FTDH4). The Kionix recommended default value for the high limit is 0.05 seconds and for the low limit is 0.005 seconds (0xA2h). Note that to properly change the value of this register, the PC1 bit in CTRL_REG1 must first be set to “0”.

R/W	R/W	R/W	R/W	R/W	R/W	R/W	R/W	
FTDH4	FTDH3	FTDH2	FTDH1	FTDH0	FTDL2	FTDL1	FTDL0	Reset Value
Bit7	Bit6	Bit5	Bit4	Bit3	Bit2	Bit1	Bit0	10100010
								I ² C Address: 0x2Eh



± 2g / 4g / 8g Tri-axis Digital Accelerometer Specifications

PART NUMBER:

**KXTIK-1004
Rev. 2
Dec-2011**

TDT_TOTAL_TIMER

This register contains counter information for the detection of a double tap event. When the Directional Tap™ ODR is 400Hz or less, every count is calculated as 1/ODR delay period. When the Directional Tap™ ODR is 800Hz, every count is calculated as 2/ODR delay period. When the Directional Tap™ ODR is 1600Hz, every count is calculated as 4/ODR delay period. The Directional Tap™ ODR is user-defined per Table 15. In order to ensure that only tap events are detected, this time limit is used. This register sets the total amount of time that the two taps in a double tap event can be above the PI threshold (TDT_L_THRESH). The Kionix recommended default value for TDT_TOTAL_TIMER is 0.09 seconds (0x24h). Note that to properly change the value of this register, the PC1 bit in CTRL_REG1 must first be set to “0”.

R/W	R/W	R/W	R/W	R/W	R/W	R/W	R/W	
STD7	STD6	STD5	STD4	STD3	STD2	STD1	STD0	Reset Value
Bit7	Bit6	Bit5	Bit4	Bit3	Bit2	Bit1	Bit0	00100100
I ² C Address: 0x2Fh								

TDT_LATENCY_TIMER

This register contains counter information for the detection of a tap event. When the Directional Tap™ ODR is 400Hz or less, every count is calculated as 1/ODR delay period. When the Directional Tap™ ODR is 800Hz, every count is calculated as 2/ODR delay period. When the Directional Tap™ ODR is 1600Hz, every count is calculated as 4/ODR delay period. The Directional Tap™ ODR is user-defined per Table 15. In order to ensure that only tap events are detected, this time limit is used. This register sets the total amount of time that the tap algorithm will count samples that are above the PI threshold (TDT_L_THRESH) during a potential tap event. It is used during both single and double tap events. However, reporting of single taps on the physical interrupt pin (11) will occur at the end of the TDT_WINDOW_TIMER. The Kionix recommended default value for TDT_LATENCY_TIMER is 0.1 seconds (0x28h). Note that to properly change the value of this register, the PC1 bit in CTRL_REG1 must first be set to “0”.

R/W	R/W	R/W	R/W	R/W	R/W	R/W	R/W	
TLT7	TLT6	TLT5	TLT4	TLT3	TLT2	TLT1	TLT0	Reset Value
Bit7	Bit6	Bit5	Bit4	Bit3	Bit2	Bit1	Bit0	00101000
I ² C Address: 0x30h								

TDT_WINDOW_TIMER

This register contains counter information for the detection of single and double taps. When the Directional Tap™ ODR is 400Hz or less, every count is calculated as 1/ODR delay period. When the Directional Tap™ ODR is 800Hz, every count is calculated as 2/ODR delay period. When the Directional Tap™ ODR is 1600Hz, every count is calculated as 4/ODR delay period. The Directional Tap™ ODR is user-defined per Table 15. It defines the time window for the entire tap event, single or double, to occur. Reporting of single taps on the physical interrupt pin (11) will occur at the end of this tap window. The Kionix recommended default value for TDT_WINDOW_TIMER is 0.4 seconds



± 2g / 4g / 8g Tri-axis Digital Accelerometer Specifications

PART NUMBER:

**KXTIK-1004
Rev. 2
Dec-2011**

(0xA0h). Note that to properly change the value of this register, the PC1 bit in CTRL_REG1 must first be set to "0".

R/W	R/W	R/W	R/W	R/W	R/W	R/W	R/W	
TWS7	TWS6	TWS5	TWS4	TWS3	TWS2	TWS1	TWS0	Reset Value
Bit7	Bit6	Bit5	Bit4	Bit3	Bit2	Bit1	Bit0	10100000
								I ² C Address: 0x31h

BUF_CTRL1

Read/write control register that controls the buffer sample threshold.

R/W	R/W	R/W	R/W	R/W	R/W	R/W	R/W	
-	SMP_TH6	SMP_TH5	SMP_TH4	SMP_TH3	SMP_TH2	SMP_TH1	SMP_TH0	Reset Value
Bit7	Bit6	Bit5	Bit4	Bit3	Bit2	Bit1	Bit0	00000000
								I ² C Address: 0x32h

SMP_TH[6:0] Sample Threshold; determines the number of samples that will trigger a watermark interrupt or will be saved prior to a trigger event. When BUF_RES=1, the maximum number of samples is 41; when BUF_RES=0, the maximum number of samples is 84.

Buffer Model	Sample Function
Bypass	None
FIFO	Specifies how many buffer sample are needed to trigger a watermark interrupt.
Stream	Specifies how many buffer samples are needed to trigger a watermark interrupt.
Trigger	Specifies how many buffer samples before the trigger event are retained in the buffer.
FILO	Specifies how many buffer samples are needed to trigger a watermark interrupt.

Table 21. Sample Threshold Operation by Buffer Mode



± 2g / 4g / 8g Tri-axis Digital Accelerometer Specifications

PART NUMBER:

**KXTIK-1004
Rev. 2
Dec-2011**

BUF_CTRL2

Read/write control register that controls sample buffer operation.

R/W	R/W	R/W	R/W	R/W	R/W	R/W	R/W	
BUFE	BUF_RES	0	0	0	0	BUF_M1	BUF_M0	Reset Value
Bit7	Bit6	Bit5	Bit4	Bit3	Bit2	Bit1	Bit0	00000000
								I ² C Address: 0x33h

BUFE controls activation of the sample buffer.

BUFE = 0 – sample buffer inactive

BUFE = 1 – sample buffer active

BUF_RES determines the resolution of the acceleration data samples collected by the sample buffer.

BUF_RES = 0 – 8-bit samples are accumulated in the buffer

BUF_RES = 1 – 12-bit samples are accumulated in the buffer

BUF_M1, BUF_M0 selects the operating mode of the sample buffer per Table 22.

BUF_M1	BUF_M0	Mode	Description
0	0	FIFO	The buffer collects 84 sets of 8-bit low resolution values or 41 sets of 12bit high resolution values and then stops collecting data, collecting new data only when the buffer is not full.
0	1	Stream	The buffer holds the last 84 sets of 8-bit low resolution values or 41 sets of 12bit high resolution values. Once the buffer is full, the oldest data is discarded to make room for newer data.
1	0	Trigger	When a trigger event occurs, the buffer holds the last data set of SMP[6:0] samples before the trigger event and then continues to collect data until full. New data is collected only when the buffer is not full.
1	1	FILO	The buffer holds the last 84 sets of 8-bit low resolution values or 41 sets of 12bit high resolution values. Once the buffer is full, the oldest data is discarded to make room for newer data. Reading from the buffer in this mode will return the most recent data first.

Table 22. Selected Buffer Mode



± 2g / 4g / 8g Tri-axis Digital Accelerometer Specifications

PART NUMBER:

KXTIK-1004
Rev. 2
Dec-2011

BUF_STATUS_REG1

This register reports the status of the sample buffer.

R/W	R/W	R/W	R/W	R/W	R/W	R/W	R/W
SMP_LEV7	SMP_LEV6	SMP_LEV5	SMP_LEV4	SMP_LEV3	SMP_LEV2	SMP_LEV1	SMP_LEV0
Bit7	Bit6	Bit5	Bit4	Bit3	Bit2	Bit1	Bit0
I ² C Address: 0x34h							

SMP_LEV[7:0] Sample Level; reports the number of data bytes that have been stored in the sample buffer. When *BUF_RES=1*, this count will increase by 6 for each 3-axis sample in the buffer; when *BUF_RES=0*, the count will increase by 3 for each 3-axis sample. If this register reads 0, no data has been stored in the buffer.

BUF_STATUS_REG2

This register reports the status of the sample buffer trigger function.

R/W	R/W	R/W	R/W	R/W	R/W	R/W	R/W
BUF_TRIG	0	0	0	0	0	0	0
Bit7	Bit6	Bit5	Bit4	Bit3	Bit2	Bit1	Bit0
I ² C Address: 0x35h							

BUF_TRIG reports the status of the buffer's trigger function if this mode has been selected. When using trigger mode, a buffer read should only be performed after a trigger event.

BUF_CLEAR

Latched buffer status information and the entire sample buffer are cleared when any data is written to this register.

R/W	R/W	R/W	R/W	R/W	R/W	R/W	R/W
X	X	X	X	X	X	X	X
Bit7	Bit6	Bit5	Bit4	Bit3	Bit2	Bit1	Bit0
I ² C Address: 0x36h							



± 2g / 4g / 8g Tri-axis Digital Accelerometer Specifications

PART NUMBER:

**KXTIK-1004
Rev. 2
Dec-2011**

SELF_TEST

When 0xCA is written to this register, the MEMS self-test function is enabled. Electrostatic-actuation of the accelerometer, results in a DC shift of the X, Y and Z axis outputs. Writing 0x00 to this register will return the accelerometer to normal operation.

R/W	R/W	R/W	R/W	R/W	R/W	R/W	R/W	
1	1	0	0	1	0	1	0	Reset Value
Bit7	Bit6	Bit5	Bit4	Bit3	Bit2	Bit1	Bit0	00000000
								I ² C Address: 0x3Ah

WUF_THRESH

This register sets the acceleration threshold, WUF Threshold that is used to detect a general motion input. WUF_THRESH scales with GSEL1-GSEL0 in CTRL_REG1, and the KXTIK will ship from the factory with this value set to correspond to a change in acceleration of 0.5g when configured to +/- 8g. Note that to properly change the value of this register, the PC1 bit in CTRL_REG1 must first be set to "0".

R/W	R/W	R/W	R/W	R/W	R/W	R/W	R/W	
WUFTH7	WUFTH6	WUFTH5	WUFTH4	WUFTH3	WUFTH2	WUFTH1	WUFTH0	Reset Value
Bit7	Bit6	Bit5	Bit4	Bit3	Bit2	Bit1	Bit0	00001000
								I ² C Address: 0x5Ah

TILT_ANGLE

This register sets the tilt angle that is used to detect the transition from Face-up/Face-down states to Screen Rotation states. The KXTIK ships from the factory with tilt angle set to a low threshold of 26° from horizontal. A different default tilt angle can be requested from the factory. Note that the minimum suggested tilt angle is 10°. Note that to properly change the value of this register, the PC1 bit in CTRL_REG1 must first be set to "0".

R/W	R/W	R/W	R/W	R/W	R/W	R/W	R/W	
TA7	TA6	TA5	TA4	TA3	TA2	TA1	TA0	Reset Value
Bit7	Bit6	Bit5	Bit4	Bit3	Bit2	Bit1	Bit0	00001100
								I ² C Address: 0x5Ch



± 2g / 4g / 8g Tri-axis Digital Accelerometer Specifications

PART NUMBER:

**KXTIK-1004
Rev. 2
Dec-2011**

HYST_SET

This register sets the Hysteresis that is placed in between the Screen Rotation states. The KXTIK ships from the factory with HYST_SET set to +/-15° of hysteresis. A different default hysteresis can be requested from the factory. Note that when writing a new value to this register the current values of RES0, RES1 and RES2 must be preserved. These values are set at the factory and must not change. Note that to properly change the value of this register, the PC1 bit in CTRL_REG1 must first be set to "0".

R/W	R/W	R/W	R/W	R/W	R/W	R/W	R/W	
RES2	RES1	RES0	HYST4	HYST3	HYST2	HYST1	HYST0	Reset Value
Bit7	Bit6	Bit5	Bit4	Bit3	Bit2	Bit1	Bit0	---10100
								I ² C Address: 0x5Fh

BUF_READ

Data in the buffer can be read according to the BUF_RES and BUF_M settings in BUF_CTRL2 by executing this command. More samples can be retrieved by continuing to toggle SCL after the read command is executed. Data should only be read by set (6 bytes for high-resolution samples and 3 bytes for low-resolution samples) and by using auto-increment. Additional samples cannot be written to the buffer while data is being read from the buffer using auto-increment mode. Output data is in 2's Complement format.

R/W	R/W	R/W	R/W	R/W	R/W	R/W	R/W
X	X	X	X	X	X	X	X
Bit7	Bit6	Bit5	Bit4	Bit3	Bit2	Bit1	Bit0
							I ² C Address: 0x7Fh

	± 2g / 4g / 8g Tri-axis Digital Accelerometer Specifications	PART NUMBER: KXTIK-1004 Rev. 2 Dec-2011
---	---	--

KXTIK Embedded Applications

Orientation Detection Feature

The orientation detection feature of the KXTIK will report changes in face up, face down, +/- vertical and +/- horizontal orientation. This intelligent embedded algorithm considers very important factors that provide accurate orientation detection from low cost tri-axis accelerometers. Factors such as: hysteresis, device orientation angle and delay time are described below as these techniques are utilized inside the KXTIK.

Hysteresis

A 45° tilt angle threshold seems like a good choice because it is halfway between 0° and 90°. However, a problem arises when the user holds the device near 45°. Slight vibrations, noise and inherent sensor error will cause the acceleration to go above and below the threshold rapidly and randomly, so the screen will quickly flip back and forth between the 0° and the 90° orientations. This problem is avoided in the KXTIK by choosing a 30° threshold angle. With a 30° threshold, the screen will not rotate from 0° to 90° until the device is tilted to 60° (30° from 90°). To rotate back to 0°, the user must tilt back to 30°, thus avoiding the screen flipping problem. This example essentially applies +/- 15° of hysteresis in between the four screen rotation states. Table 23 shows the acceleration limits implemented for $\phi_T = 30^\circ$.

Orientation	X Acceleration (g)	Y Acceleration (g)
0°/360°	$-0.5 < a_x < 0.5$	$a_y > 0.866$
90°	$a_x > 0.866$	$-0.5 < a_y < 0.5$
180°	$-0.5 < a_x < 0.5$	$a_y < -0.866$
270°	$a_x < -0.866$	$-0.5 < a_y < 0.5$

Table 23. Acceleration at the four orientations with +/- 15° of hysteresis

The KXTIK allows the user to change the amount of hysteresis in between the four screen rotation states. By simply writing to the HYST_SET register, the user can adjust the amount of hysteresis up to +/- 45°. The plot in Figure 2 shows the typical amount of hysteresis applied for a given digital count value of HYST_SET.



± 2g / 4g / 8g Tri-axis Digital Accelerometer Specifications

PART NUMBER:

KXTIK-1004
Rev. 2
Dec-2011

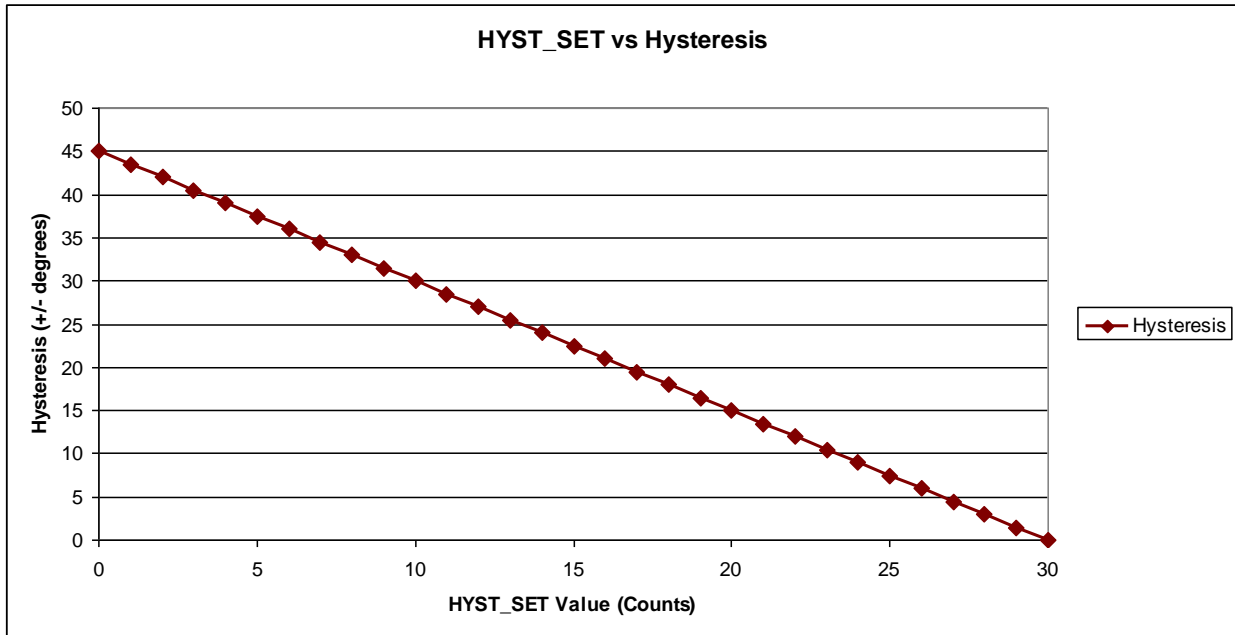

Figure 2. HYST_SET vs Hysteresis

Device Orientation Angle (aka Tilt Angle)

To ensure that horizontal and vertical device orientation changes are detected, even when it isn't in the ideal vertical orientation – where the angle θ in Figure 3 is 90° , the KXTIK considers device orientation angle in its algorithm.

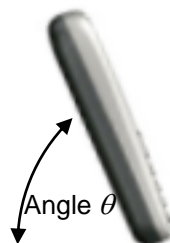

Figure 3. Device Orientation Angle

As the angle in Figure 3 is decreased, the maximum gravitational acceleration on the X-axis or Y-axis will also decrease. Therefore, when the angle becomes small enough, the user will not be able to make the screen



± 2g / 4g / 8g Tri-axis Digital Accelerometer Specifications

PART NUMBER:

KXTIK-1004
Rev. 2
Dec-2011

orientation change. When the device orientation angle approaches 0° (device is flat on a desk or table), $a_x = a_y = 0g$, $a_z = +1g$, and there is no way to determine which way the screen should be oriented, the internal algorithm determines that the device is in either the face-up or face-down orientation, depending on the sign of the z-axis. The KXTIK will only change the screen orientation when the orientation angle is above the factory-defaulted/user-defined threshold set in the TILT_ANGLE register. Equation 2 can be used to determine what value to write to the TILT_ANGLE register to set the device orientation angle.

$$\text{TILT_ANGLE (counts)} = \sin \theta * (32 \text{ (counts/g)})$$

Equation 2. Tilt Angle Threshold

Tilt Timer

The 8-bit register, TILT_TIMER can be used to qualify changes in orientation. The KXTIK does this by incrementing a counter with a size that is specified by the value in TILT_TIMER for each set of acceleration samples to verify that a change to a new orientation state is maintained. A user defined output data rate (ODR) determines the time period for each sample. Equation 3 shows how to calculate the TILT_TIMER register value for a desired delay time.

$$\text{TILT_TIMER (counts)} = \text{Delay Time (sec)} \times \text{ODR (Hz)}$$

Equation 3. Tilt Position Delay Time

Motion Interrupt Feature Description

The Motion interrupt feature of the KXTIK reports qualified changes in the high-pass filtered acceleration based on the Wake Up (WUF) threshold. If the high-pass filtered acceleration on any axis is greater than the user-defined wake up threshold (WUF_THRESH), the device has transitioned from an inactive state to an active state. When configured in the unlatched mode, the KXTIK will report when the motion event finished and the device has returned to an inactive state. Equation 4 shows how to calculate the WUF_THRESH register value for a desired wake up threshold. Note that this calculation varies based on the configured g-range of the part.

$$\text{WUF_THRESH (counts)} = \text{Wake Up Threshold (g)} \times \text{Sensitivity (counts/g)}$$

Equation 4. Wake Up Threshold



± 2g / 4g / 8g Tri-axis Digital Accelerometer Specifications

PART NUMBER:

KXTIK-1004
Rev. 2
Dec-2011

A WUF (WUF_TIMER) 8-bit raw unsigned value represents a counter that permits the user to qualify each active/inactive state change. Note that each WUF Timer count qualifies 1 (one) user-defined ODR period (OWUF). Equation 5 shows how to calculate the WUF_TIMER register value for a desired wake up delay time.

$$\text{WUF_TIMER (counts)} = \text{Wake Up Delay Time (sec)} \times \text{OWUF (Hz)}$$

Equation 5. Wake Up Delay Time

Figure 4 below shows the latched response of the motion detection algorithm with WUF Timer = 10 counts.

Typical Motion Interrupt Example

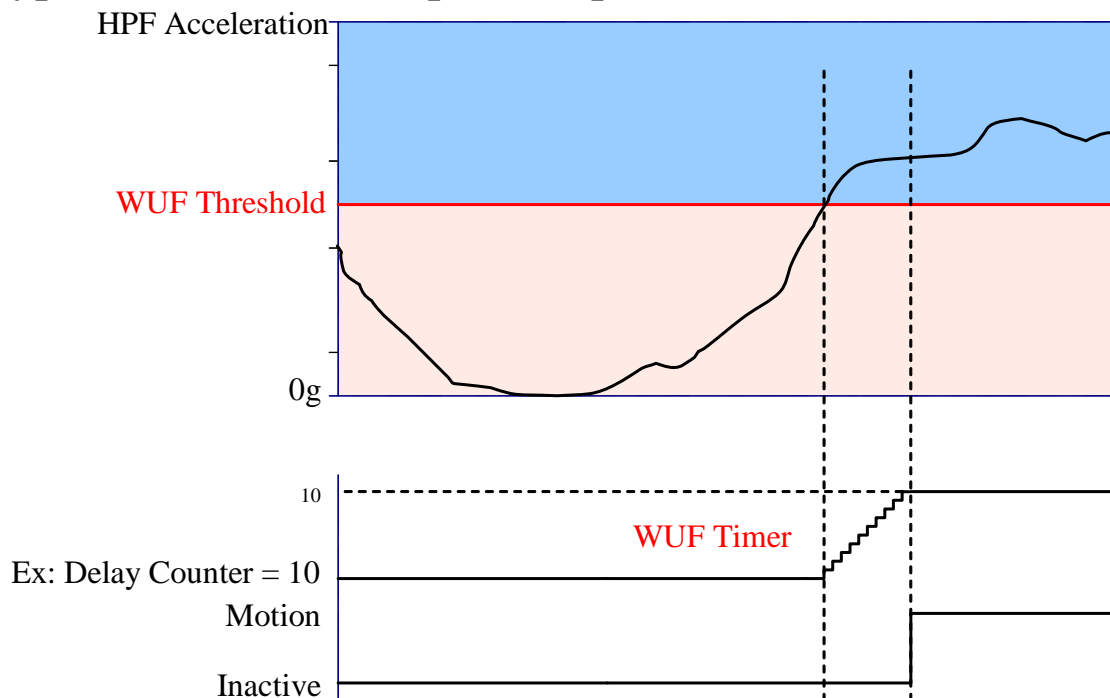

Figure 4. Latched Motion Interrupt Response



± 2g / 4g / 8g Tri-axis Digital Accelerometer Specifications

PART NUMBER:
KXTIK-1004
Rev. 2
Dec-2011

Figure 5 below shows the unlatched response of the motion detection algorithm with WUF Timer = 10 counts.

Typical Motion Interrupt Example

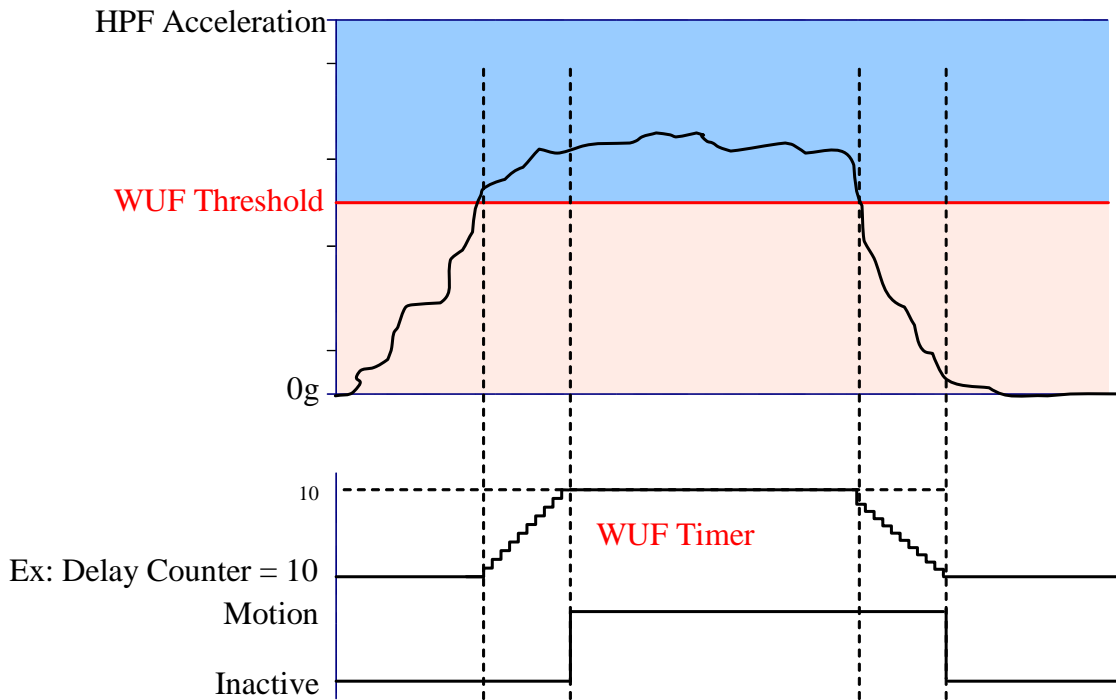

Figure 5. Unlatched Motion Interrupt Response



± 2g / 4g / 8g Tri-axis Digital Accelerometer Specifications

PART NUMBER:

KXTIK-1004
Rev. 2
Dec-2011

Directional Tap Detection Feature Description

The Directional Tap Detection feature of the KXTIK recognizes single and double tap inputs and reports the acceleration axis and direction that each tap occurred. Eight performance parameters, as well as a user-selectable ODR are used to configure the KXTIK for a desired tap detection response.

Performance Index

The Directional Tap™ detection algorithm uses low and high thresholds to help determine when a tap event has occurred. A tap event is detected when the previously described jerk summation exceeds the low threshold (TDT_L_THRESH) for more than the tap detection low limit, but less than the tap detection high limit as contained in TDT_TAP_TIMER. Samples that exceed the high limit (TDT_H_THRESH) will be ignored. Figure 6 shows an example of a single tap event meeting the performance index criteria.

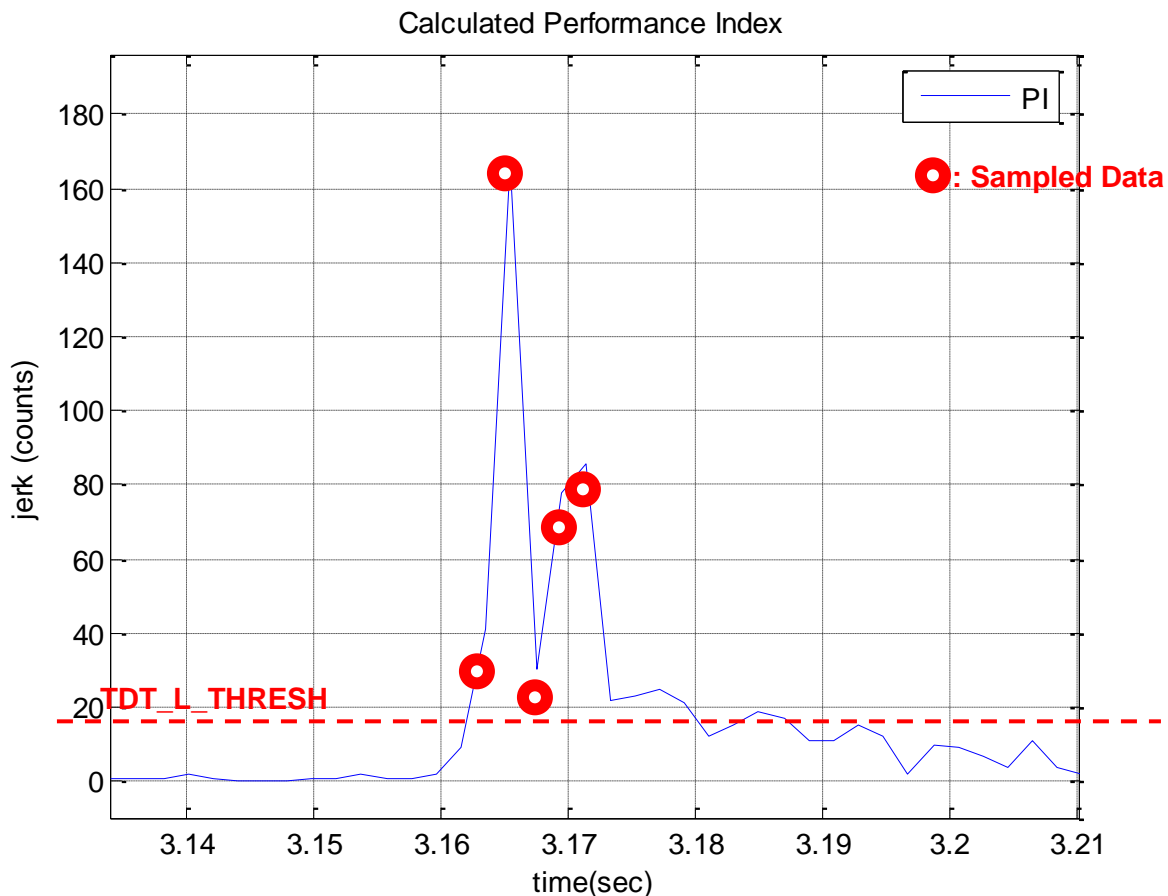

Figure 6. Jerk Summation vs Threshold



± 2g / 4g / 8g Tri-axis Digital Accelerometer Specifications

PART NUMBER:

KXTIK-1004
Rev. 2
Dec-2011

Single Tap Detection

The latency timer (TDT_LATENCY_TIMER) sets the time period that a tap event will only be characterized as a single tap. A second tap has to occur outside of the latency timer. If a second tap occurs inside the latency time, it will be ignored as it occurred too quickly. The single tap will be reported at the end of the TDT_WINDOW_TIMER. Figure 7 shows a single tap event meeting the PI, latency and window requirements.

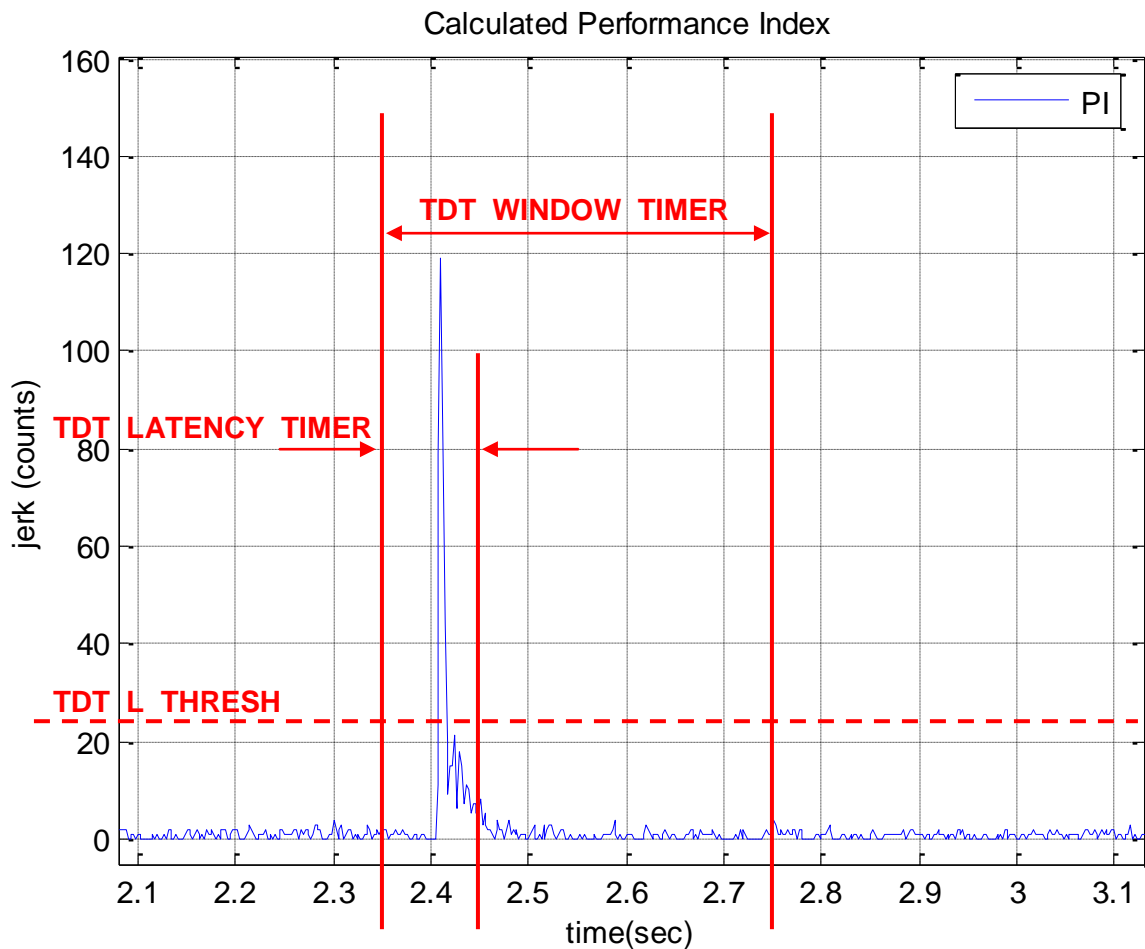

Figure 7. Single Directional Tap™ Timing



± 2g / 4g / 8g Tri-axis Digital Accelerometer Specifications

PART NUMBER:

KXTIK-1004
Rev. 2
Dec-2011

Double Tap Detection

An event can be characterized as a double tap only if the second tap crosses the performance index (TDT_L_THRESH) outside the TDT_TIMER. This means that the TDT_TIMER determines the minimum time separation that must exist between the two taps of a double tap event. Similar to the single tap, the second tap event must exceed the performance index for the time limit contained in TDT_TAP_TIMER. The double tap will be reported at the end of the second TDT_LATENCY_TIMER. Figure 8 shows a double tap event meeting the PI, latency and window requirements.

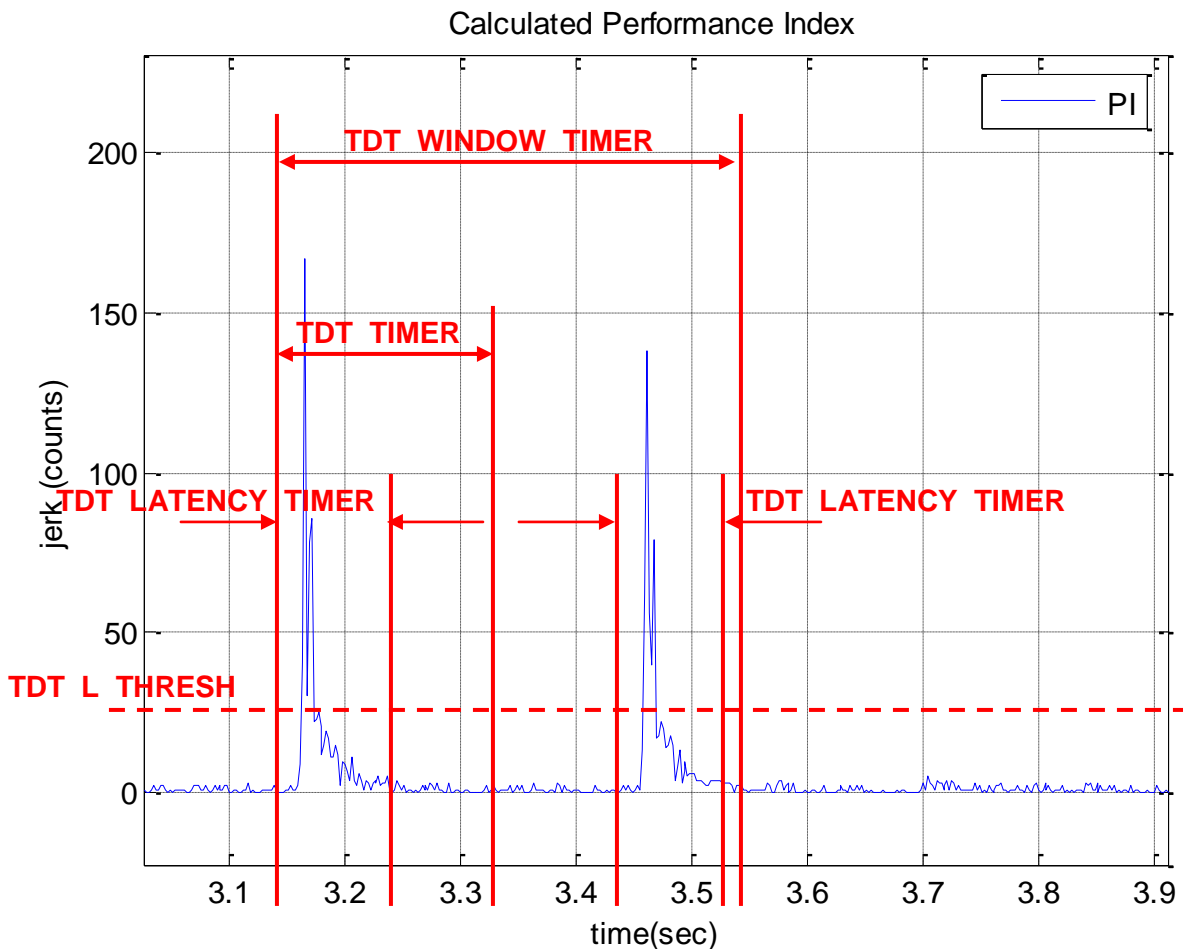

Figure 8. Double Directional Tap™ Timing

	± 2g / 4g / 8g Tri-axis Digital Accelerometer Specifications	PART NUMBER: KXTIK-1004 Rev. 2 Dec-2011
---	---	--

Sample Buffer Feature Description

The sample buffer feature of the KXTIK accumulates and outputs acceleration data based on how it is configured. There are 4 buffer modes available, and samples can be accumulated at either low (8-bit) or high (12-bit) resolution. Acceleration data is collected at the ODR specified by OSAA:OSAD in the Output Data Control Register. Each buffer mode accumulates data, reports data, and interacts with status indicators in a slightly different way.

FIFO Mode

Data Accumulation

Sample collection stops when the buffer is full.

Data Reporting

Data is reported with the oldest byte of the oldest sample first (X_L or X based on resolution).

Status Indicators

A watermark interrupt occurs when the number of samples in the buffer reaches the Sample Threshold. The watermark interrupt stays active until the buffer contains less than this number of samples. This can be accomplished through clearing the buffer or explicitly reading greater than SMPX samples (calculated with Equation 6).

BUF_RES=0:

$$SMPX = SMP_LEV[7:0] / 3 - SMP_TH[6:0]$$

BUF_RES=1:

$$SMPX = SMP_LEV[7:0] / 6 - SMP_TH[6:0]$$

Equation 6. Samples Above Sample Threshold

Stream Mode

Data Accumulation

Sample collection continues when the buffer is full; older data is discarded to make room for newer data.

Data Reporting

Data is reported with the oldest sample first (uses FIFO read pointer).

Status Indicators

A watermark interrupt occurs when the number of samples in the buffer reaches the Sample Threshold. The watermark interrupt stays active until the buffer contains less than this number of samples. This can be accomplished through clearing the buffer or explicitly reading greater than SMPX samples (calculated with Equation 1).



± 2g / 4g / 8g Tri-axis Digital Accelerometer Specifications

PART NUMBER:

KXTIK-1004
Rev. 2
Dec-2011

Trigger Mode

Data Accumulation

When a physical interrupt is caused by one of the digital engines, the trigger event is asserted and SMP[6:0] samples prior to the event are retained. Sample collection continues until the buffer is full.

Data Reporting

Data is reported with the oldest sample first (uses FIFO read pointer).

Status Indicators

When a physical interrupt occurs and there are at least SMP[6:0] samples in the buffer, BUF_TRIG in BUF_STATUS_REG2 is asserted.

FILO Mode

Data Accumulation

Sample collection continues when the buffer is full; older data is discarded to make room for newer data.

Data Reporting

Data is reported with the newest byte of the newest sample first (Z_H or Z based on resolution).

Status Indicators

A watermark interrupt occurs when the number of samples in the buffer reaches the Sample Threshold. The watermark interrupt stays active until the buffer contains less than this number of samples. This can be accomplished through clearing the buffer or explicitly reading greater than SMPX samples (calculated with Equation 1).

Buffer Operation

The following diagrams illustrate the operation of the buffer conceptually. Actual physical implementation has been abstracted to offer a simplified explanation of how the different buffer modes operate. Figure 9 represents a high-resolution 3-axis sample within the buffer. Figures 10-19 represent a 10-sample version of the buffer (for simplicity), with Sample Threshold set to 8.

Regardless of the selected mode, the buffer fills sequentially, one byte at a time. Figure 9 shows one 6-byte data sample. Note the location of the FILO read pointer versus that of the FIFO read pointer.



± 2g / 4g / 8g Tri-axis Digital Accelerometer Specifications

PART NUMBER:

**KXTIK-1004
Rev. 2
Dec-2011**

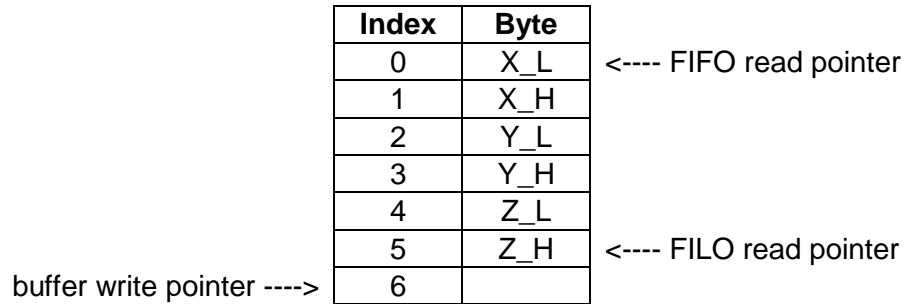

Figure 9. One Buffer Sample

Regardless of the selected mode, the buffer fills sequentially, one sample at a time. Note in Figure 10 the location of the FILO read pointer versus that of the FIFO read pointer. The buffer write pointer shows where the next sample will be written to the buffer.

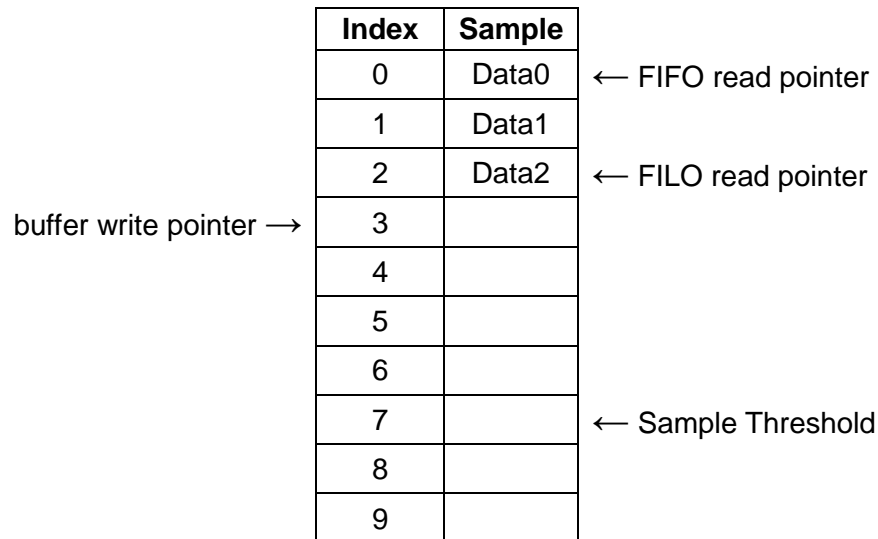

Figure 10. Buffer Filling



± 2g / 4g / 8g Tri-axis Digital Accelerometer Specifications

PART NUMBER:

**KXTIK-1004
Rev. 2
Dec-2011**

The buffer continues to fill sequentially until the Sample Threshold is reached. Note in Figure 11 the location of the FILO read pointer versus that of the FIFO read pointer.

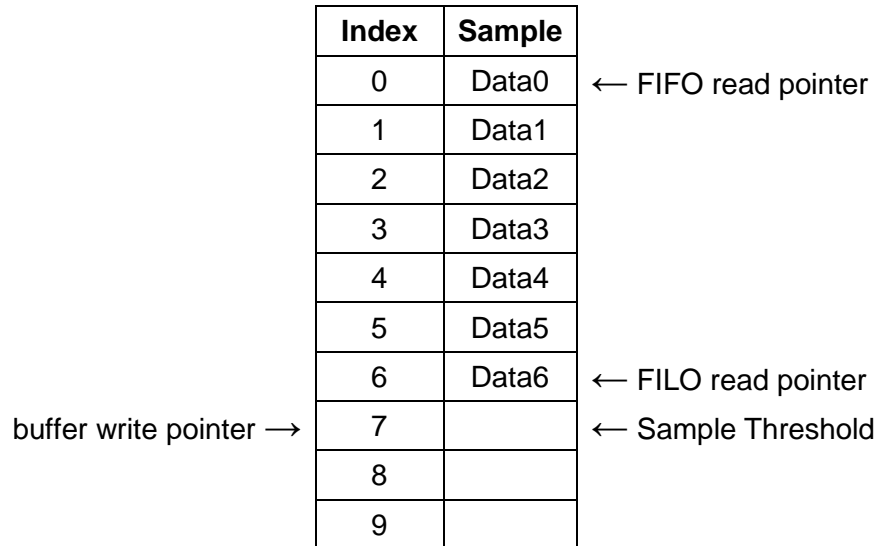

Figure 11. Buffer Approaching Sample Threshold

In FIFO, Stream, and FILO modes, a watermark interrupt is issued when the number of samples in the buffer reaches the Sample Threshold. In trigger mode, this is the point where the oldest data in the buffer is discarded to make room for newer data.

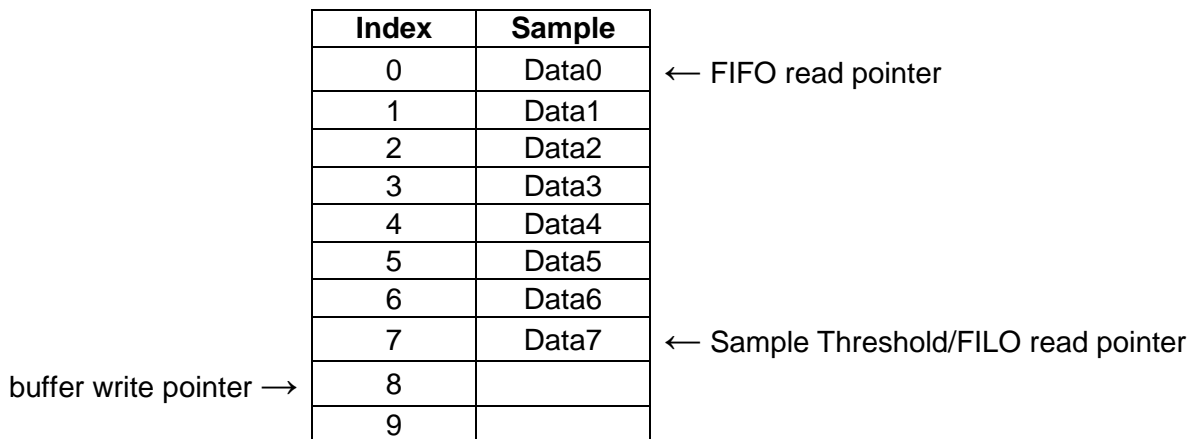

Figure 12. Buffer at Sample Threshold



± 2g / 4g / 8g Tri-axis Digital Accelerometer Specifications

PART NUMBER:

**KXTIK-1004
Rev. 2
Dec-2011**

In trigger mode, data is accumulated in the buffer sequentially until the Sample Threshold is reached. Once the Sample Threshold is reached, the oldest samples are discarded when new samples are collected. Note in Figure 13 how Data0 was thrown out to make room for Data8.

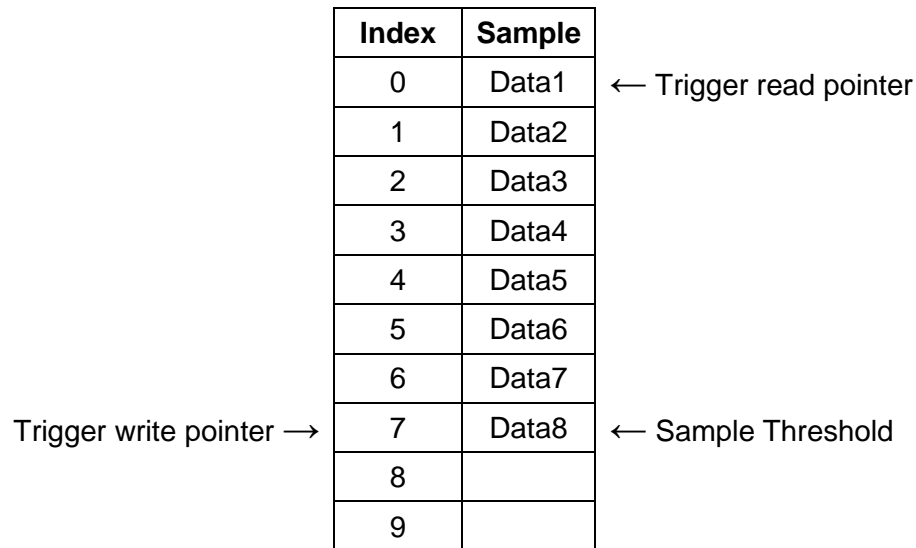

Figure 13. Additional Data Prior to Trigger Event

After a trigger event occurs, the buffer no longer discards the oldest samples, and instead begins accumulating samples sequentially until full. The buffer then stops collecting samples, as seen in Figure 14. This results in the buffer holding SMP_TH[6:0] samples prior to the trigger event, and SMPX samples after the trigger event.

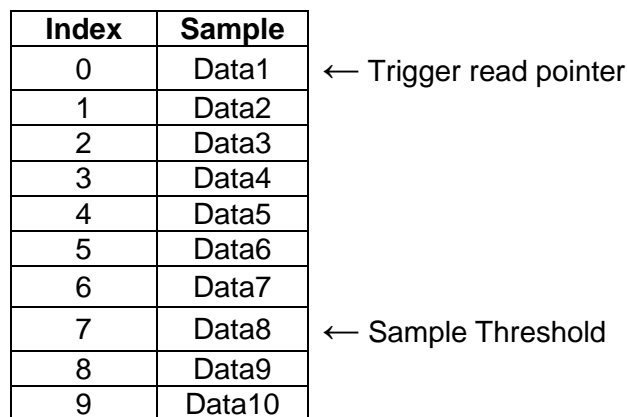

Figure 14. Additional Data After Trigger Event



± 2g / 4g / 8g Tri-axis Digital Accelerometer Specifications

PART NUMBER:

**KXTIK-1004
Rev. 2
Dec-2011**

In FIFO, Stream, FILO, and Trigger (after a trigger event has occurred) modes, the buffer continues filling sequentially after the Sample Threshold is reached. Sample accumulation after the buffer is full depends on the selected operation mode. FIFO and Trigger modes stop accumulating samples when the buffer is full, and Stream and FILO modes begin discarding the oldest data when new samples are accumulated.

Index	Sample	
0	Data0	← FIFO read pointer
1	Data1	
2	Data2	
3	Data3	
4	Data4	
5	Data5	
6	Data6	
7	Data7	← Sample Threshold
8	Data8	
9	Data9	← FILO read pointer

Figure 15. Buffer Full

After the buffer has been filled in FILO or Stream mode, the oldest samples are discarded when new samples are collected. Note in Figure 16 how Data0 was thrown out to make room for Data10.

Index	Sample	
0	Data1	← FIFO read pointer
1	Data2	
2	Data3	
3	Data4	
4	Data5	
5	Data6	
6	Data7	
7	Data8	← Sample Threshold
8	Data9	
9	Data10	← FILO read pointer

Figure 16. Buffer Full – Additional Sample Accumulation in Stream or FILO Mode



± 2g / 4g / 8g Tri-axis Digital Accelerometer Specifications

PART NUMBER:

**KXTIK-1004
Rev. 2
Dec-2011**

In FIFO, Stream, or Trigger mode, reading one sample from the buffer will remove the oldest sample and effectively shift the entire buffer contents up, as seen in Figure 17.

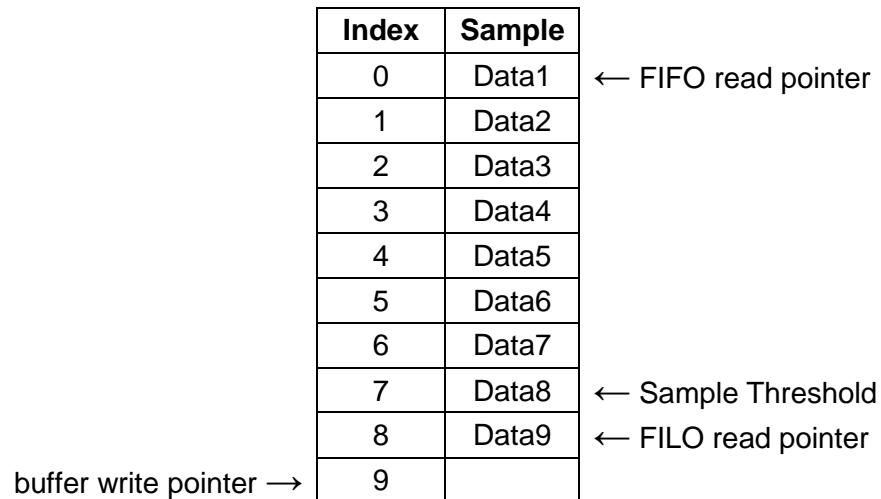

Figure 17. FIFO Read from Full Buffer

In FILO mode, reading one sample from the buffer will remove the newest sample and leave the older samples untouched, as seen in Figure 18.

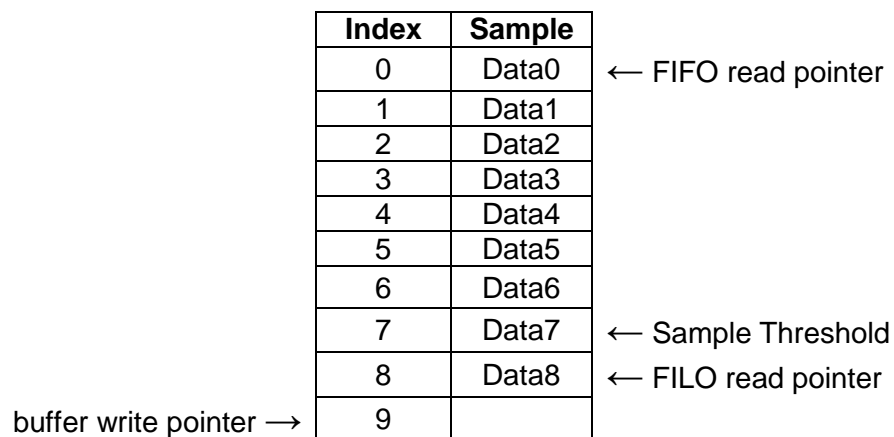



Figure 18. FILO Read from Full Buffer

	± 2g / 4g / 8g Tri-axis Digital Accelerometer Specifications	PART NUMBER: KXTIK-1004 Rev. 2 Dec-2011
---	---	--

Revision History

REVISION	DESCRIPTION	DATE
1	Initial Product Release	19-Jul-2011
2	Adjusted Pin Descriptions for Pins 2, 13 and 16	14-Dec-2011

"Kionix" is a registered trademark of Kionix, Inc. Products described herein are protected by patents issued or pending. No license is granted by implication or otherwise under any patent or other rights of Kionix. The information contained herein is believed to be accurate and reliable but is not guaranteed. Kionix does not assume responsibility for its use or distribution. Kionix also reserves the right to change product specifications or discontinue this product at any time without prior notice. This publication supersedes and replaces all information previously supplied.