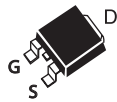
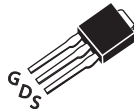
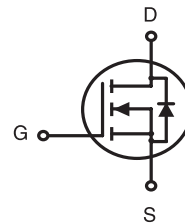

**N-Channel Field Effect Transistor****PRODUCT SUMMARY**

V <sub>DSS</sub>	I <sub>D</sub>	R <sub>DS(ON)</sub> (Ω) Typ
250V	2A	3.2 @ V <sub>GS</sub> =10V

**FEATURES**

- Super high dense cell design for low R<sub>DS(ON)</sub>.
- Rugged and reliable.
- Surface Mount Package.

SDU SERIES  
TO - 252AA(D-PAK)SDD SERIES  
TO - 251(I-PAK)**ABSOLUTE MAXIMUM RATINGS** (T<sub>A</sub>=25°C unless otherwise noted)

Symbol	Parameter	Limit	Units
V <sub>DS</sub>	Drain-Source Voltage	250	V
V <sub>GS</sub>	Gate-Source Voltage	±30	V
I <sub>D</sub>	Drain Current-Continuous	T <sub>A</sub> =25°C	2
		T <sub>A</sub> =70°C	1.5
I <sub>DM</sub>	-Pulsed <sup>a</sup>	6	A
E <sub>AS</sub>	Single Pulse Avalanche Energy <sup>c</sup>	10.4	mJ
P <sub>D</sub>	Maximum Power Dissipation	T <sub>A</sub> =25°C	42
		T <sub>A</sub> =70°C	27
T <sub>J</sub> , T <sub>STG</sub>	Operating Junction and Storage Temperature Range	-55 to 150	°C

**THERMAL CHARACTERISTICS**

R <sub>θJC</sub>	Thermal Resistance, Junction-to-Case	3	°C/W
R <sub>θJA</sub>	Thermal Resistance, Junction-to-Ambient	50	°C/W

# SDU/D02N25

Ver 1.1

## ELECTRICAL CHARACTERISTICS (TA=25°C unless otherwise noted)

Symbol	Parameter	Conditions	Min	Typ	Max	Units
<b>OFF CHARACTERISTICS</b>						
BV <sub>DSS</sub>	Drain-Source Breakdown Voltage	V <sub>GS</sub> =0V , I <sub>D</sub> =250uA	250			V
I <sub>DSS</sub>	Zero Gate Voltage Drain Current	V <sub>DS</sub> =200V , V <sub>GS</sub> =0V			1	uA
I <sub>GSS</sub>	Gate-Body Leakage Current	V <sub>GS</sub> = ±30V , V <sub>DS</sub> =0V			±100	nA
<b>ON CHARACTERISTICS</b>						
V <sub>GS(th)</sub>	Gate Threshold Voltage	V <sub>DS</sub> =V <sub>GS</sub> , I <sub>D</sub> =250uA	2	3	4	V
R <sub>DS(ON)</sub>	Drain-Source On-State Resistance	V <sub>GS</sub> =10V , I <sub>D</sub> =1A		3.2	4.2	ohm
g <sub>FS</sub>	Forward Transconductance	V <sub>DS</sub> =10V , I <sub>D</sub> =1A		0.9		S
<b>DYNAMIC CHARACTERISTICS<sup>b</sup></b>						
C <sub>ISS</sub>	Input Capacitance	V <sub>DS</sub> =25V, V <sub>GS</sub> =0V f=1.0MHz		185		pF
C <sub>OSS</sub>	Output Capacitance			31		pF
C <sub>RSS</sub>	Reverse Transfer Capacitance			6.1		pF
<b>SWITCHING CHARACTERISTICS<sup>b</sup></b>						
t <sub>D(ON)</sub>	Turn-On Delay Time	V <sub>DD</sub> =125V I <sub>D</sub> =1A V <sub>GS</sub> =10V R <sub>GEN</sub> =25 ohm		13.4		ns
t <sub>r</sub>	Rise Time			12.2		ns
t <sub>D(OFF)</sub>	Turn-Off Delay Time			21.5		ns
t <sub>f</sub>	Fall Time			5.6		ns
Q <sub>g</sub>	Total Gate Charge	V <sub>DS</sub> =125V, I <sub>D</sub> =1A, V <sub>GS</sub> =10V		4.36		nC
Q <sub>gs</sub>	Gate-Source Charge	V <sub>DS</sub> =125V, I <sub>D</sub> =1A, V <sub>GS</sub> =10V		1.28		nC
Q <sub>gd</sub>	Gate-Drain Charge			1.48		nC
<b>DRAIN-SOURCE DIODE CHARACTERISTICS AND MAXIMUM RATINGS</b>						
V <sub>SD</sub>	Diode Forward Voltage	V <sub>GS</sub> =0V, I <sub>S</sub> =1A		0.81	1.4	V

### Notes

- a. Pulse Test: Pulse Width < 300us, Duty Cycle < 2%.
- b. Guaranteed by design, not subject to production testing.
- c. Starting T<sub>J</sub>=25°C, L=1mH, R<sub>G</sub>=25Ω, V<sub>DD</sub> = 50V. (See Figure12)

Jun,07,2012

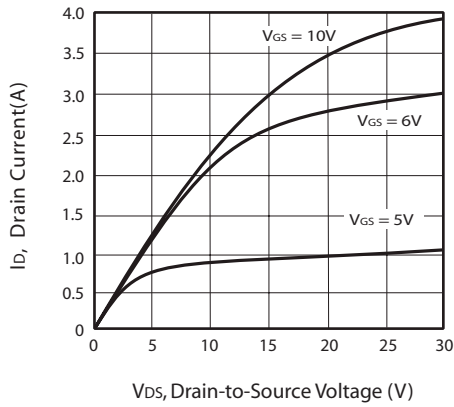

Figure 1. Output Characteristics

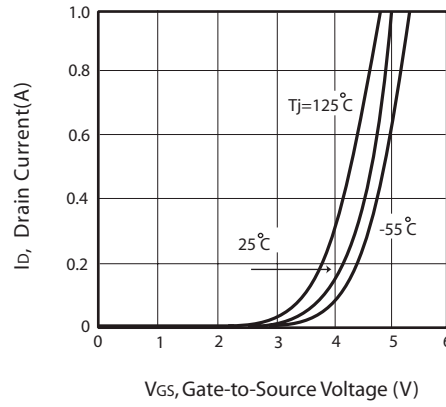

Figure 2. Transfer Characteristics

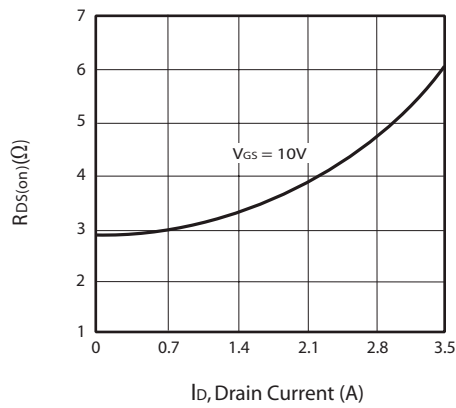

Figure 3. On-Resistance vs. Drain Current and Gate Voltage

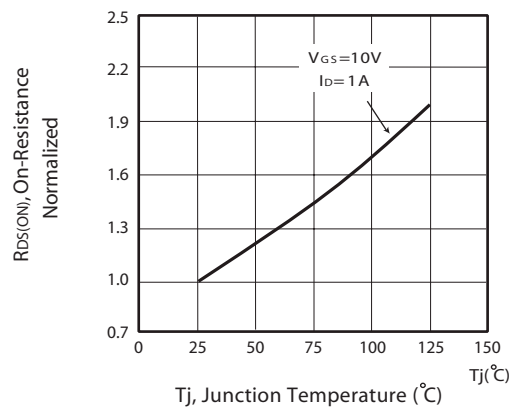

Figure 4. On-Resistance Variation with Drain Current and Temperature

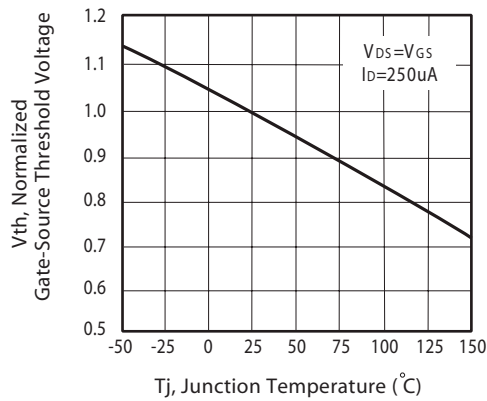

Figure 5. Gate Threshold Variation with Temperature

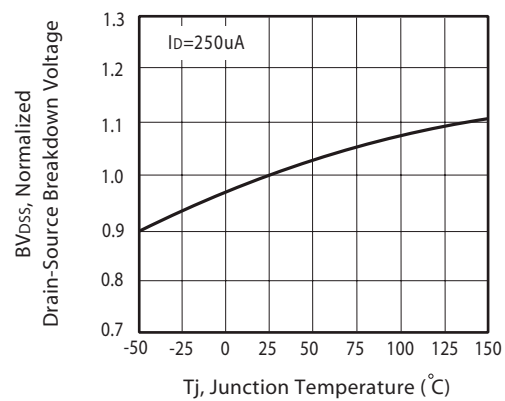

Figure 6. Breakdown Voltage Variation with Temperature

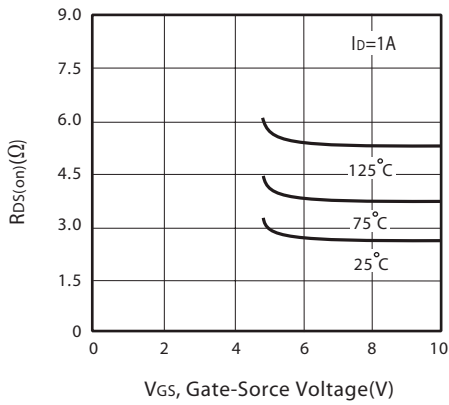

Figure 7. On-Resistance vs. Gate-Source Voltage

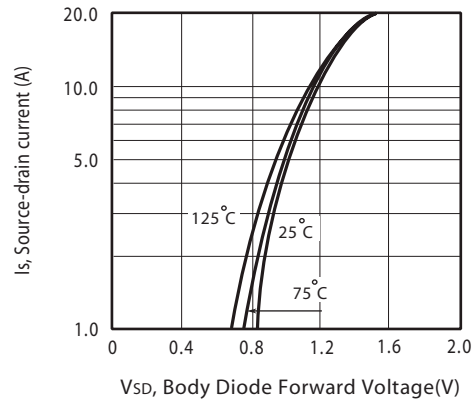

Figure 8. Body Diode Forward Voltage Variation with Source Current

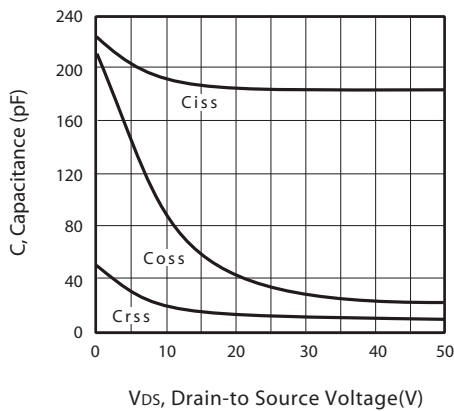

Figure 9. Capacitance

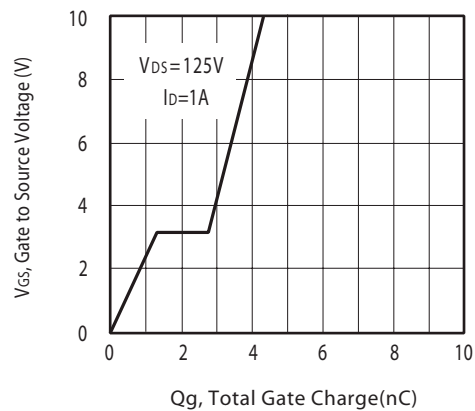

Figure 10. Gate Charge

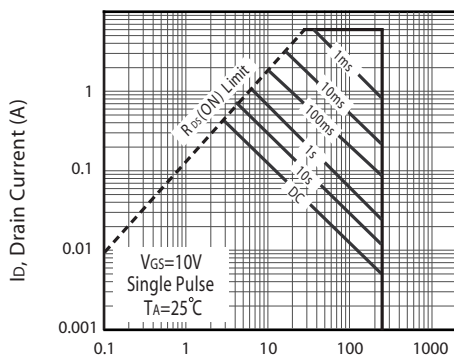
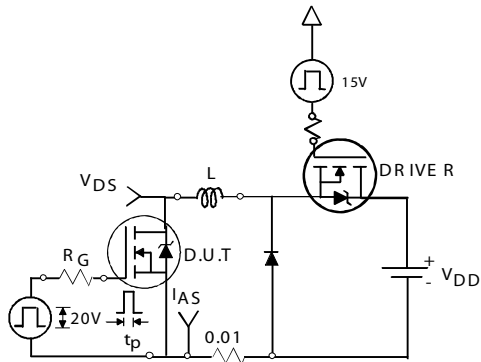
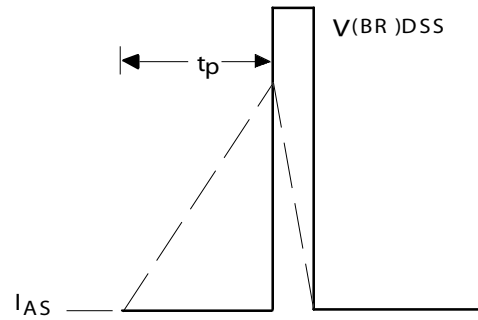

Figure 11. Maximum Safe Operating Area



Unclamped Inductive Test Circuit

Figure 13a.



Unclamped Inductive Waveforms

Figure 13b.

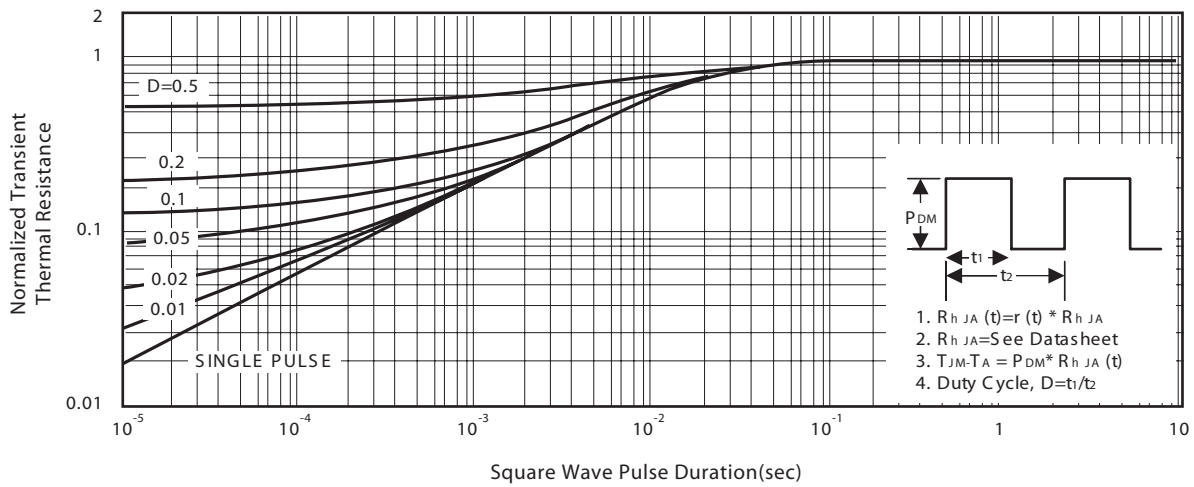
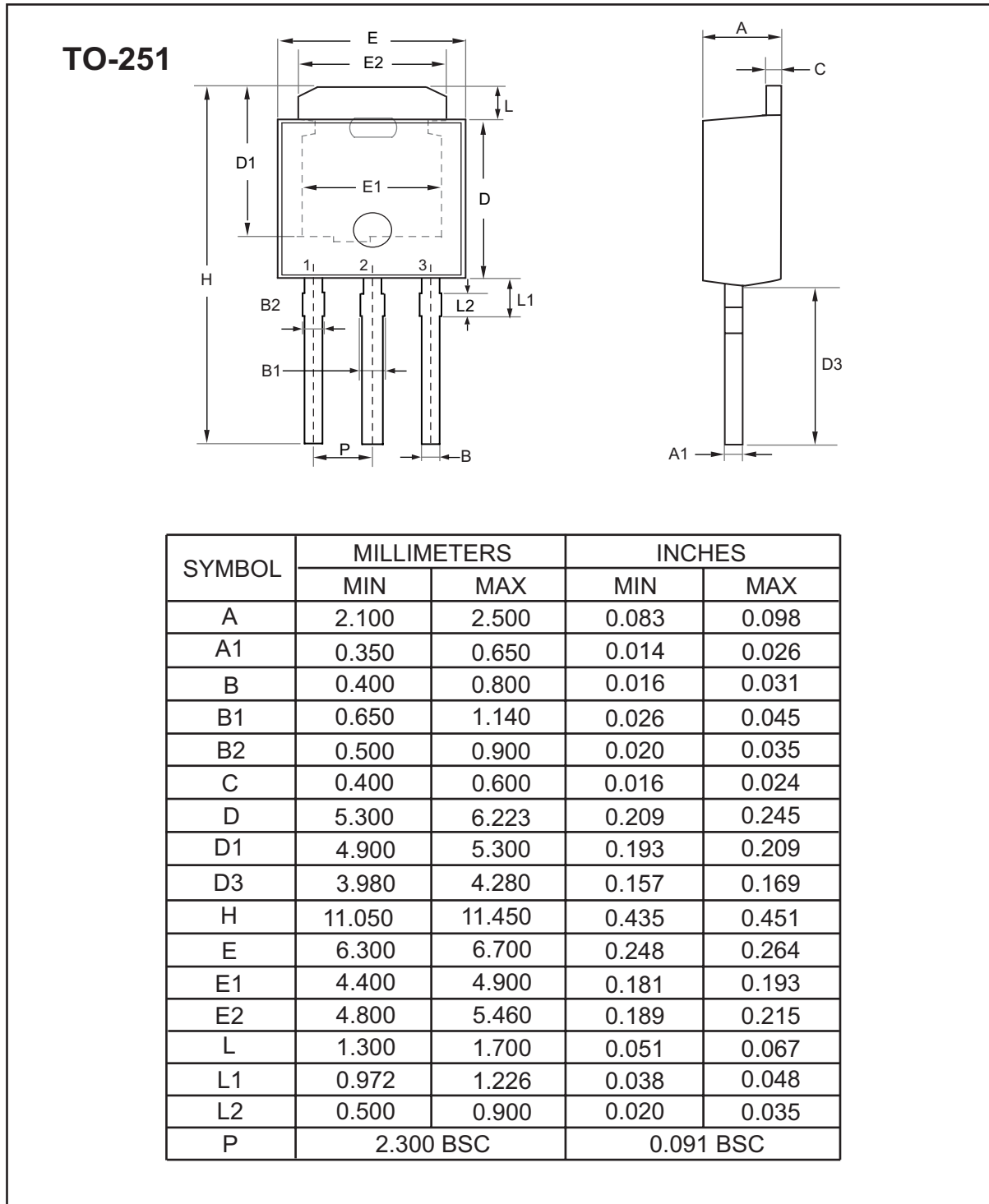

Figure 14. Normalized Thermal Transient Impedance Curve

## PACKAGE OUTLINE DIMENSIONS



# SDU/D02N25

Ver 1.1

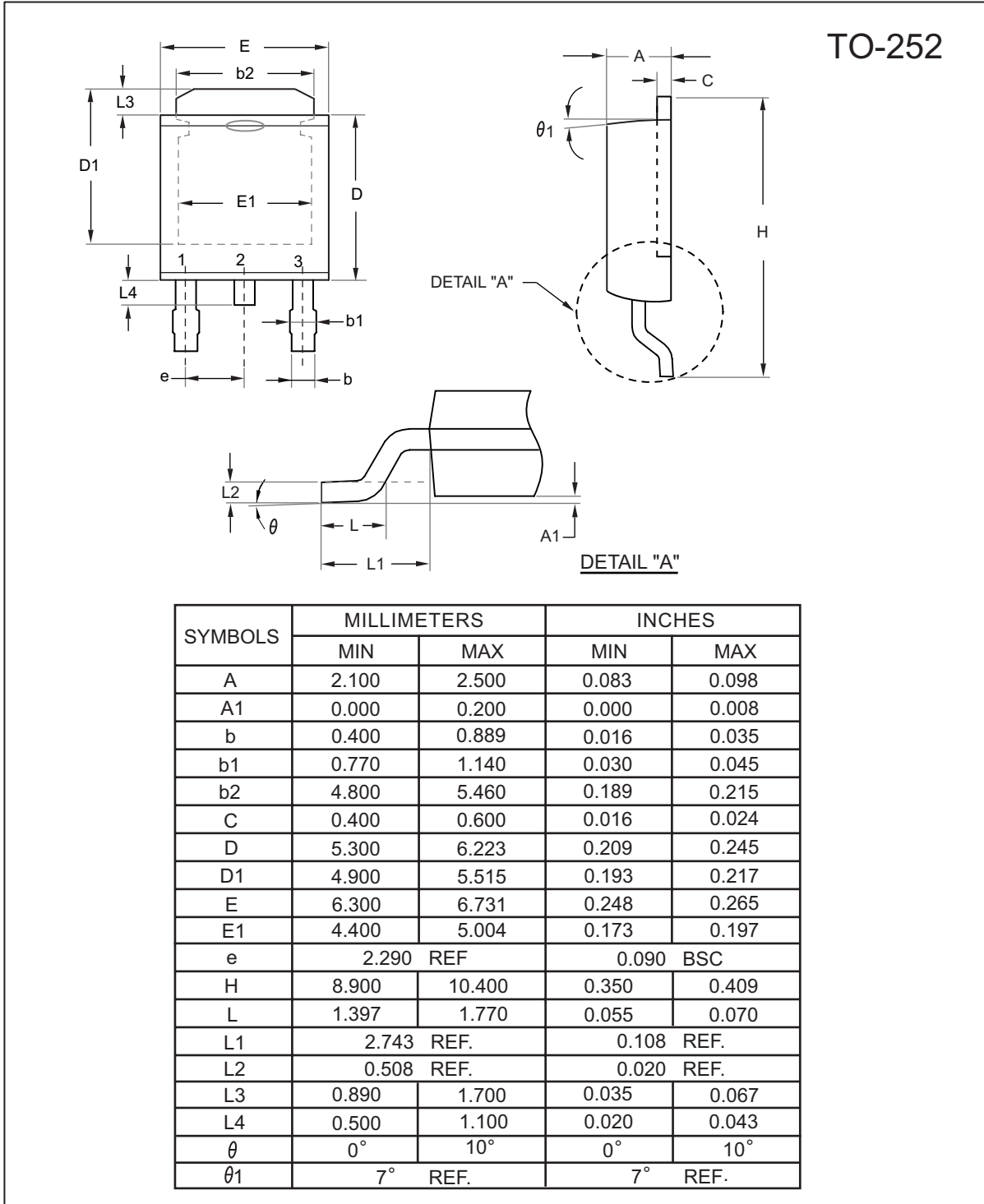

Jun,07,2012

## TO-251 Tube/TO-252 Tape and Reel Data

### TO-251 Tube

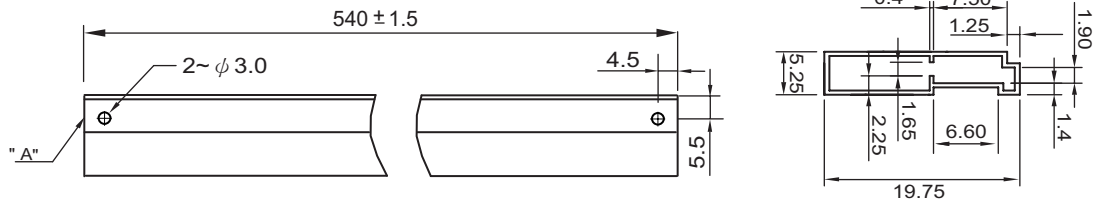

### TO-252 Carrier Tape

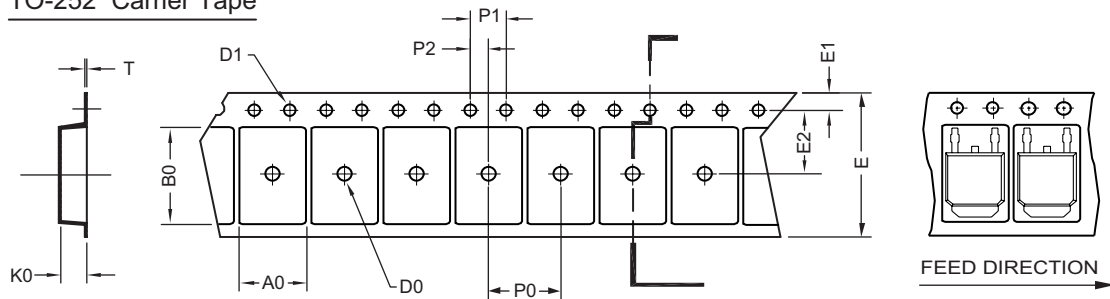

UNIT:mm

PACKAGE	A0	B0	K0	D0	D1	E	E1	E2	P0	P1	P2	T
TO-252 (16 mm)	6.96 ±0.1	10.49 ±0.1	2.79 ±0.1	φ 2	φ 1.5 + 0.1 - 0	16.0 ±0.3	1.75 ±0.1	7.5 ±0.15	8.0 ±0.1	4.0 ±0.1	2.0 ±0.15	0.3 ±0.05

### TO-252 Reel

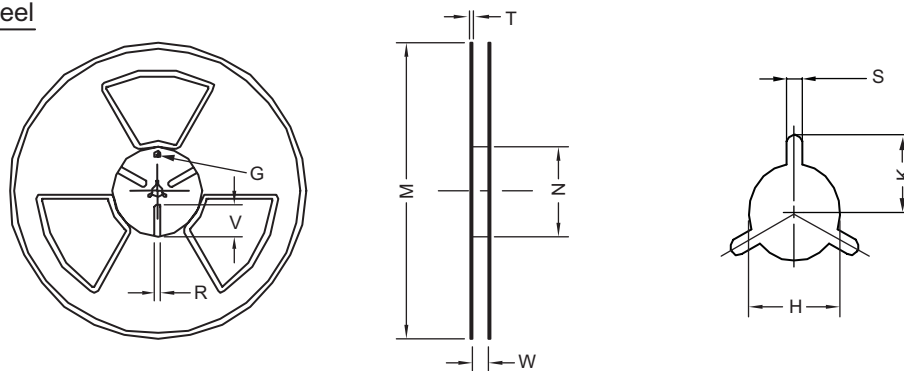

UNIT:mm

TAPE SIZE	REEL SIZE	M	N	W	T	H	K	S	G	R	V
16 mm	φ 330	φ 330 ± 0.5	φ 97 ± 1.0	17.0 + 1.5 - 0	2.2	φ 13.0 + 0.5 - 0.2	10.6	2.0 ±0.5	---	---	---