

SERVICE MANUAL

BG-3S CHASSIS

<u>MODEL</u>	<u>COMMANDER</u>	<u>DEST.</u>	<u>CHASSIS NO.</u>	<u>MODEL</u>	<u>COMMANDER</u>	<u>DEST.</u>	<u>CHASSIS NO.</u>
KV-PF21L70	RM-952	ME	SCC-U30B-A				
KV-PF21M40	RM-952	GE	SCC-U12N-A				
KV-PF21M70	RM-952	E	SCC-U13E-A				
KV-PF21M70	RM-952	ME	SCC-U30C-A				
KV-PF21P10	RM-952	OCE	SCC-U24D-A				
KV-PF21P40	RM-952	Singapore	SCC-U29B-A				
KV-PF21P40	RM-952	Malaysia	SCC-U21C-A				
KV-PF21P41	RM-952	Malaysia	SCC-U21E-A				
KV-PF21Q70	RM-952	ME	SCC-U30A-A				

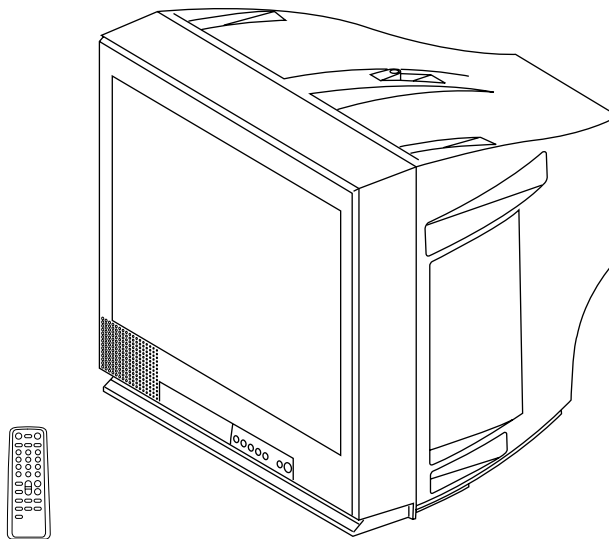

TRINITRON® COLOR TV
SONY®

SPECIFICATIONS

		Note
Power requirements	110-240 V AC, 50/60 Hz	Except Malaysia and OCE
	220-240V AC, 50/60Hz	For Malaysia and OCE
Power consumption (W)	Indicated on the rear of the TV	
Television system	B/G, I, D/K, M	KV-PF21M40/PF21M70
	B/G	Except KV-PF21M40/PF21M70
Color system	PAL, PAL60, SECAM, NTSC4.43, NTSC3.58	KV-PF21M70 (ME)/ KV-PF21M40/PF21M70(E)
	PAL, PAL60, NTSC4.43, NTSC3.58 (AV IN)	KV-PF21P10/PF21P40/PF21P41
	PAL, PAL60, SECAM, NTSC4.43, NTSC3.58 (AV IN)	KV-PF21L70
	PAL, PAL60, SECAM, NTSC4.43	PF21Q70
Teletext language	English, Arabic, French	KV-PF21P41 only
Channel coverage B/G	VHF : E2 to E12/ UHF : E21 to E69/ CATV : S01 to S03, S1 to S41	
	VHF : 0 to 12, 5A, 9A UHF : 28 to 69 CATV : S01 to S03, S1 to S41	Australia only
	VHF : 1 to 11 UHF : 21 to 69 CATV : S01 to S03, S1 to S41	New Zealand only
I	UHF : B21 to B68/ CATV : S01 to S03, S1 to S41	KV-PF21M40/PF21M70
D/K	VHF : C1 to C12, R1 to R12/ UHF : C13 to C57, R21 to R60 CATV: Z1 to Z39, S01 to S03, S1 to S41	KV-PF21M40/PF21M70
M	VHF : A2 to A13/ UHF : A14 to A79/ CATV : A-8 to A-2, A to W+4, W+6 to W+84	KV-PF21M40/PF21M70
ㄗ (Antenna)	75-ohm external terinal	
Audio output	3W	
Number of terminal		
Ⓜ (Video)	Input : 2 Output : 1 Phono jacks; 1 Vp-p, 75 ohms	
♪ (Audio)	Input : 2 Output : 1 Phono jacks; 500 mVrms	
📞 (Earphone)	Output : 1 Minijack	
Picture tube	21 inch	
Tube size (cm)	54	Measured diagonally
Screen size (cm)	51	Measured diagonally
Dimension (w/h/d, mm)	490 x 458 x 487	
Mass (kg)	25	

Design and specifications are subject to change without notice.

CAUTION

SHORT CIRCUIT THE ANODE OF THE PICTURE TUBE AND THE ANODE CAP TO THE METAL CHASSIS, CRT SHIELD, OR CARBON PAINTED ON THE CRT, AFTER REMOVING THE ANODE.

SAFETY-RELATED COMPONENT WARNING!!

COMPONENTS IDENTIFIED BY SHADING AND MARK **⚠** ON THE SCHEMATIC DIAGRAMS, EXPLODED VIEWS AND IN THE PARTS LIST ARE CRITICAL TO SAFE OPERATION. REPLACE THESE COMPONENTS WITH SONY PARTS WHOSE PART NUMBERS APPEAR AS SHOWN IN THIS MANUAL OR IN SUPPLEMENTS PUBLISHED BY SONY. CIRCUIT ADJUSTMENTS THAT ARE CRITICAL TO SAFE OPERATION ARE IDENTIFIED IN THIS MANUAL. FOLLOW THESE PROCEDURES WHENEVER CRITICAL COMPONENTS ARE REPLACED OR IMPROPER OPERATION IS SUSPECTED.

TABLE OF CONTENTS

<u>Section</u>	<u>Title</u>	<u>Page</u>	<u>Section</u>	<u>Title</u>	<u>Page</u>
	SELF DIAGNOSIS FUNCTION	4	5. DIAGRAMS		
1. GENERAL		8	5-1	Block Diagram	41
2. DISASSEMBLY			5-2	Frame Schematic Diagram	44
2-1.	Rear Cover Removal	23	5-3	Circuit Boards Location	46
2-2.	Chassis Assy Removal	23	5-4	Schematic Diagrams and Printed Wiring Boards ...	47
2-3.	F Bracket Removal	23	(1)	Schematic Diagram of A(1/2) Board	49
2-4.	Service Position	23	(2)	Schematic Diagram of A(2/2) Board	53
2-5.	Replacement of Parts	24	(3)	Schematic Diagrams of C3 and F Boards	61
2-5-1.	Replacement of Control Button	24	(4)	Schematic Diagram of V1 Board	65
2-5-2.	Replacement of Bar Control	24	5-5	Semiconductors	68
2-6.	Terminal Bracket Removal	24	6. EXPLODED VIEW		
2-7.	V1 Board Removal	24	6-1.	Chassis	71
2-8.	Degauss Coil Removal	25	7. ELECTRICAL PARTS LIST		73
2-9.	Picture Tube Removal	25			
3. SET-UP ADJUSTMENTS					
3-1.	Beam Landing	27			
3-2.	Convergence	28			
3-3.	Focus Adjustment	30			
3-4.	G2 (Screen) and White Balance Adjustments	30			
4. CIRCUIT ADJUSTMENTS					
4-1.	Adjustments with Commander	31			
4-2.	Adjustment Method	32			
4-3.	Picture Quality Adjustments	37			
4-4.	A Board Adjustment After IC003 (Memory) Replacement	37			
4-5.	Picture Distortion Adjustment	38			

SELF DIAGNOSTIC FUNCTION

The units in this manual contain a self-diagnostic function. If an error occurs, the STANDBY/TIMER lamp will automatically begin to flash.

The number of times the lamp flashes translates to a probable source of the problem. A definition of the STANDBY/TIMER lamp flash indicators is listed in the instruction manual for the user's knowledge and reference. If an error symptom cannot be reproduced, the remote commander can be used to review the failure occurrence data stored in memory to reveal past problems and how often these problems occur.

1. DIAGNOSTIC TEST INDICATORS

When an errors occurs, the STANDBY/TIMER lamp will flash a set number of times to indicate the possible cause of the problem. If there is more than one error, the lamp will identify the first of the problem areas.

Result for all of the following diagnostic items are displayed on screen. No error has occurred if the screen displays a "0".

Diagnostic Item Description	No. of times STANDBY/TIMER lamp flashes	Self-diagnostic display/Diagnostic result	Probable Cause Location	Detected Symptoms
• Power does not turn on	Does not light	—	<ul style="list-style-type: none"> • Power cord is not plugged in. • Fuse is burned out F4601 (F Board) 	<ul style="list-style-type: none"> • Power does not come on. • No power is supplied to the TV. • AC power supply is faulty.
<ul style="list-style-type: none"> • +B overcurrent (OCP) or overvoltage (OVP) • Vertical deflection stopped • Horizontal deflection overdrive 	2 times	002:000 or 002:001~255 003:001~255 004:001~255 at the same time	<ul style="list-style-type: none"> • H.OUT Q511 is shorted. (A board) • -13V is not supplied. (A board) • IC 503 faulty (A board) • IC 301 faulty (A board) 	<ul style="list-style-type: none"> • Power does not come on. • Load on power line is shorted. • Has entered standby state after horizontal raster. • Vertical deflection pulse is stopped. • Power line is shorted or power supply is stopped.
• White balance failure (no PICTURE)	5 times	005:000 or 005:001~225	<ul style="list-style-type: none"> • G2 is improperly adjusted. (Note 2) • CRT problem. • IC301 is faulty. (A board) • No connection A board to C3 board. 	<ul style="list-style-type: none"> • No raster is generated. • CRT cathode current detection reference pulse output is small.
• Micro reset	—	101:00 or 101:001~225	<ul style="list-style-type: none"> • Discharge CRT (C3 Board) • Static discharge • External noise 	<ul style="list-style-type: none"> • Power is shut down shortly, after this return back to normal. • Detect Micro latch up.

Note 1: If a + B overcurrent is detected, stoppage of the vertical deflection is detected simultaneously.

The symptom that is diagnosed first by the microcontroller is displayed on the screen.

Note 2: Refer to screen (G2) Adjustment in section 3-4 of this manual.

2. DISPLAY OF STANDBY/TIMER LIGHT FLASH COUNT

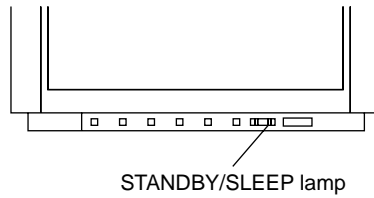
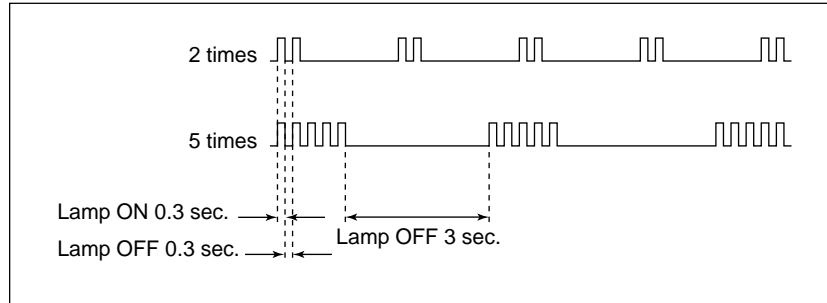

<u>Diagnostic Item</u>	<u>Flash Count*</u>
+B overcurrent/overvoltage Vertical deflection stopped	2 times
White balance failure	5 times

* One flash count is not used for self-diagnostic.

3. STOPPING THE STANDBY/TIMER FLASH

Turn off the power switch on the TV main unit or unplug the power cord from the outlet to stop the STANDBY/TIMER lamp from flashing.

4. SELF-DIAGNOSTIC SCREEN DISPLAY

For errors with symptoms such as “power sometimes shuts off” or “screen sometimes goes out” that cannot be confirmed, it is possible to bring up past occurrences of failure for confirmation on the screen:

[To Bring Up Screen Test]

In standby mode, press buttons on the remote commander sequentially in rapid succession as shown below:

Screen display → channel [5] → Sound volume [−] → Power ON



Note that this differs from entering the service mode (mode volume [+]).

Self-Diagnosis screen display

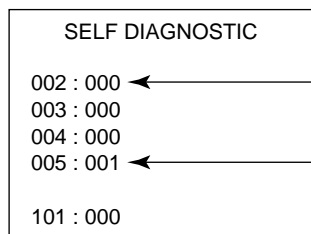

Numeral "0" means that no fault has been detected.

Numeral "1" means a fault has been detected.

5. HANDLING OF SELF-DIAGNOSTIC SCREEN DISPLAY

Since the diagnostic results displayed on the screen are not automatically cleared, always check the self-diagnostic screen during repairs. When you have completed the repairs, clear the result display to “0”.

Unless the result display is cleared to “0”, the self-diagnostic function will not be able to detect subsequent faults after completion of the repairs.

[Clearing the result display]

To clear the result display to “0”, press buttons on the remote commander sequentially as shown below when the diagnostic screen is being displayed.

Channel [8] → 0

[Quitting Self-diagnostic screen]

To quit the entire self-diagnostic screen, turn off the power switch on the remote commander or the main unit.

6. SELF-DIAGNOSTIC CIRCUIT

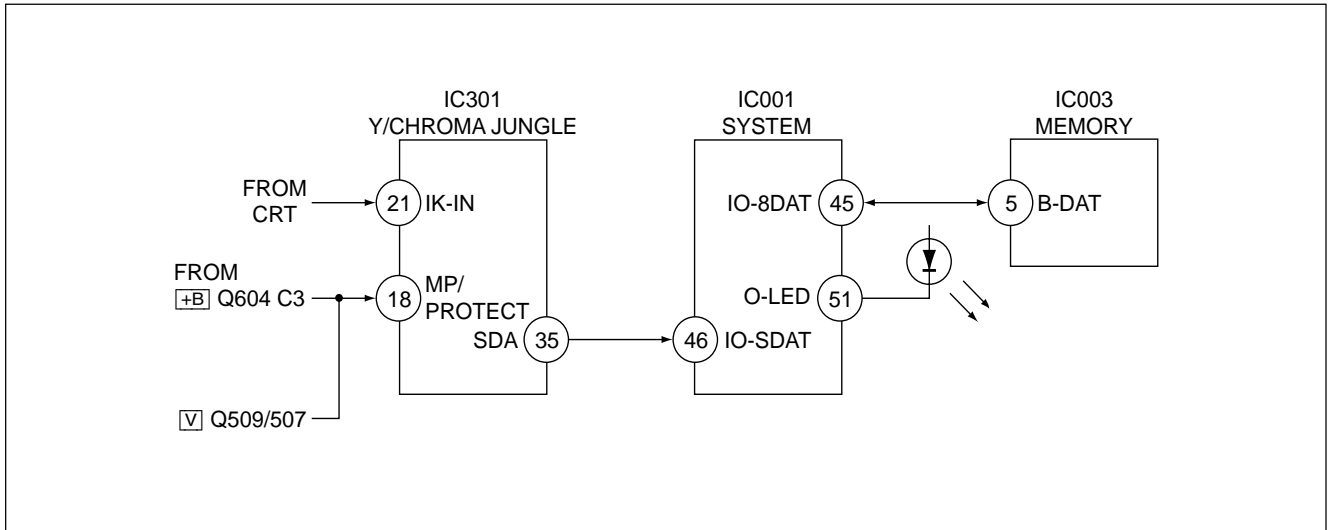

+B overcurrent (OCP)

Occurs when an overcurrent on the +B(135) line is detected by Q604. If Q604 go to ON and the voltage to pin 18 of IC301 should go down when V.SYNC is more than seven verticals in a period, the unit will automatically turn off.

Vertical deflection stopped

Occurs when an absence of the vertical deflection pulse is detected by Q509 and IC001 shut down the power supply.

Vertical deflection overcurrent

Occurs when an overcurrent on V drive line is detected by Q507. Power supply will be shut down when detect this by IC001.

White balance failure

If the RGB levels* do not balance or become low level within 5 seconds, this error will be detected by IC301. TV will stay on, but there will be no picture.







* (Refers to the RGB levels of the AKB detection Ref pulse that detects IK.)

The operating instructions mentioned here are partial abstracts from the Operating Instruction Manual. The page numbers of the Operating Instruction Manual remain as in the manual.

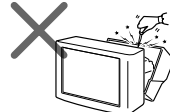
SECTION 1 GENERAL

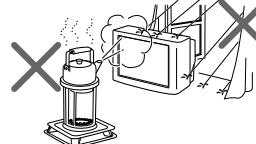
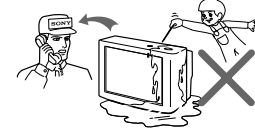
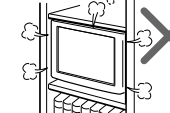
WARNING

- Dangerously high voltages are present inside the TV.
- TV operating voltage: 110 – 240 V AC. (For Malaysia only: 220 – 240 V AC.)

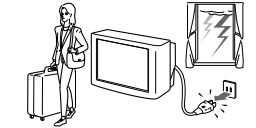
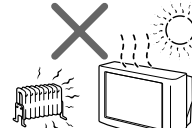
 <p>Do not open the cabinet and the rear cover of the TV. Refer servicing to qualified personnel.</p>	 <p>Install the TV in a stable position. Do not allow children to climb onto it.</p>
 <p>To prevent fire or shock hazard, do not expose the TV to rain or moisture.</p>	 <p>Do not operate the TV if any liquid or solid object falls into it. Have it checked immediately by qualified personnel only.</p>
 <p>Do not install the TV in a confined space, such as a bookcase or built-in cabinet. Do not block the ventilation openings of the TV.</p>	 <p>Clean the TV with a dry and soft cloth. Do not use benzene, thinner, or any other chemicals to clean the TV. Do not scratch the picture tube.</p>
 <p>Do not pull the power cord to disconnect the TV. Pull it out by the plug.</p>	 <p>Do not plug in too many appliances to the same power socket. Do not damage the power cord.</p>
 <p>Disconnect the power cord during lightning storms or if you are not going to use the TV for several days.</p>	 <p>Do not install the TV in hot, humid or excessively dusty places.</p>

Using Your New TV

Getting Started

Step 1

Connect the antenna (Except KV-PF21P10)

If you wish to connect a VCR, see the "Connecting a VCR" diagram below.

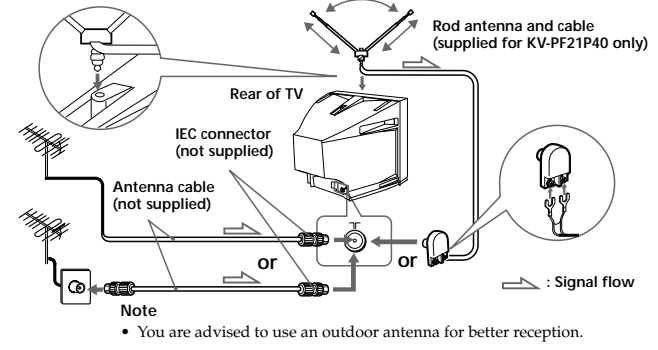

Connecting a VCR

To watch the video, press  (see page 12).

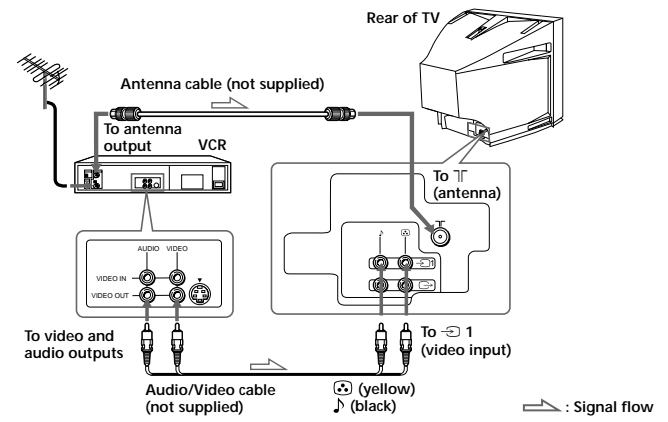

Getting Started

Step 1

Connect the antenna (PF21P10)

If you wish to connect a VCR, see the "Connecting a VCR" diagram below.

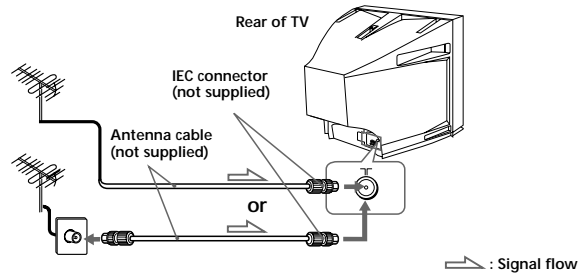

Notes

- If you connect a stereo VCR, connect the yellow plug to (the yellow jack) and the white plug to (the black jack).
- If you connect a VCR to the (antenna) terminal, preset the signal output from the VCR to the program number 0 on the TV.
- When no signal is input to the connected video equipment, the TV screen becomes blue.

CAUTION

Do not connect the power cord until you have completed making all other connections; otherwise a minimum leakage current might flow through the antenna and other terminals to ground.

Step 2

Insert the batteries into the remote

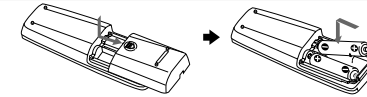

Note

- Do not use old batteries nor use different types of batteries together.

Step 3

Preset the channels automatically

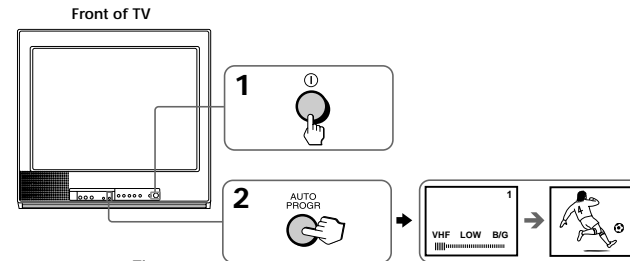

Tips

- If you want to stop automatic channel presetting, press SELECT twice.
- If your TV has preset an unwanted channel or cannot preset a particular channel, then preset your TV manually (see page 9).

Note (KV-PF21M40/PF21M70 only)

- During automatic channel presetting, your TV screen will indicate "B/G", "I", "D/K" or "M" for the TV system.

Now You Are Ready. . .

To watch your TV, see page 11.

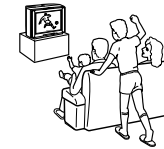

Connecting optional components

You can connect optional video components, such as a VCR, multi disc player, camcorder or video game.

To watch the picture of the connected equipment, press (see page 12).

Connecting a camcorder/video game equipment using the 2 (video input) jacks

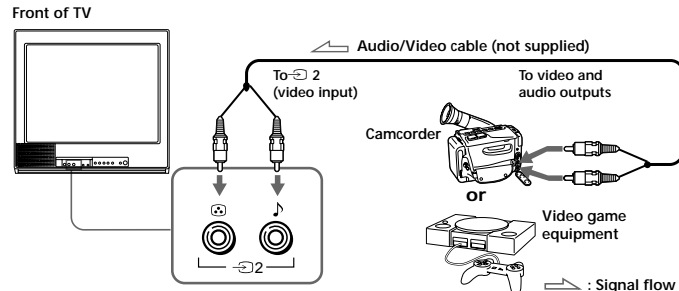

Note

- You can also connect video equipment to the 1 (video input) jacks at the rear of your TV.

Connecting video equipment using the (monitor output) jacks

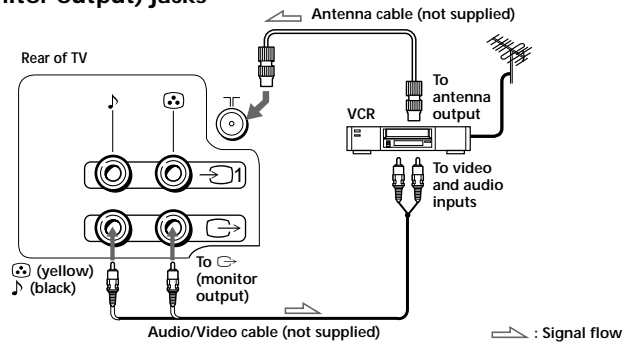

Note

- When connecting a stereo VCR, connect the yellow plug to (the yellow jack) and the white plug to (the black jack).

Securing the TV

To prevent the TV from falling, secure the TV using one of the following methods:

A With the supplied screws, attach the band to the TV stand and to the rear of the TV using the provided hole.

or

B Put the cord or chain through the clamps to secure the TV against a wall or pillar.

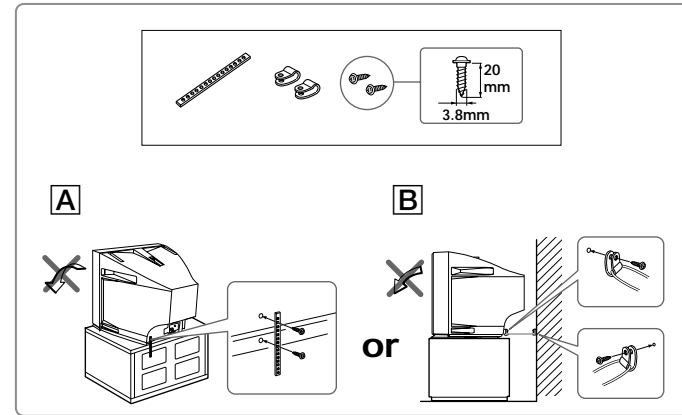

Note

- Use only the supplied screws. Use of other screws may damage the TV.

Presetting channels

You can preset up to 100 TV channels in numerical sequence from program number 1 using the remote and the buttons on your TV as well.

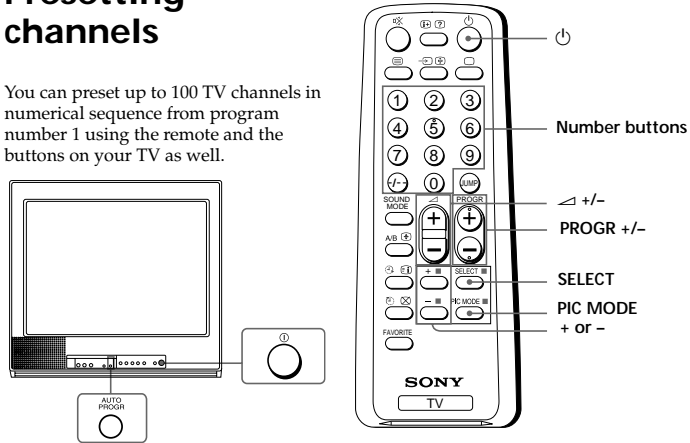

Presetting channels automatically

- 1 Press to turn on the TV.



- 2 Press AUTO PROGR.



Note (KV-PF21M40/PF21M70 only)

- During automatic channel presetting, your TV screen will indicate "B/G", "I", "D/K" or "M" for the TV system.

To preset channels automatically from a specified program number

- (1) Press SELECT until "AUTO PROGRAM" appears.
- (2) Press + or -. The on-screen display will start flashing.
- (3) Press PROGR +/- or the number buttons until the desired program number appears.
- (4) Press + or -.

8 | Using Your New TV

Presetting channels manually

- 1 Press SELECT until "MANUAL PROGRAM" appears.



- 2 Press + or -.



- 3 Press PROGR +/- or the number buttons until the desired program number appears.

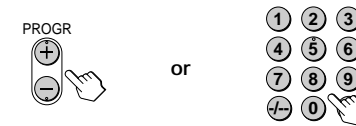

- 4 Press + or - until the desired channel picture appears.

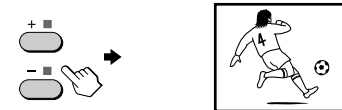

- 5 Press SELECT.



To change the color system setting (KV-PF21P10/PF21P40/PF21P41)

If the color is abnormal when receiving programs through the (antenna) terminal or the (video input) jack

- (1) Press SELECT until "COL SYS" appears.

COL SYS: AUTO

- (2) Press + or - to select the appropriate color system until the color is optimal.

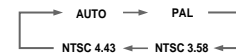

Tip

- Normally set "COL SYS" to "AUTO".

continued

Using Your New TV | 9

**To change the color system setting
(KV-PF21L70/PF21M40/PF21M70/PF21Q70)**

If the color is abnormal when receiving programs through the ㊂ (antenna) terminal or the ㊂ (video input) jack

(1) Press SELECT until "COL SYS" appears.



(2) Press + or - to select the appropriate color system until the color is optimal.



- Tip**
- Normally set "COL SYS" to "AUTO".
- Note**
- The color system "NTSC3.58" is not available for KV-PF21Q70.

Using Your New TV

continued

Presetting channels (continued)

To change the TV system setting (KV-PF21M40/PF21M70 only)

If the picture or sound is abnormal when receiving programs through the ㊂ (antenna) terminal

(1) Press SELECT until "TV SYS" appears.

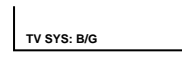

(2) Press + or - to select the appropriate TV system until the picture or sound quality is optimal.

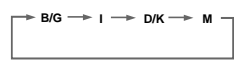

- Note**
- The TV system "I" and "M" are available for KV-PF21M70 only.

Skipping program numbers

- 1** Press PROGR +/- or the number buttons until the unused or unwanted program number appears.
- 2** Press SELECT until "MANUAL PROGRAM" appears.
- 3** Press + or -.
- 4** Press PIC MODE.
- 5** Press SELECT.

To preset the skipped program number again

Preset the channel automatically or manually.

- Tip**
- You can also use SELECT and ㊂ +/- on the TV to preset channels and skip program numbers.

To use the fine tuning (FINE) function

The fine tuning (FINE) function may help to reduce the following problems: double images and lines moving across the TV screen.

You can use the fine tuning function as below:

- (1) Select the program number you want to adjust.
- (2) Press SELECT until "MANUAL PROGRAM" appears on the screen.
- (3) Press + or - on the remote control once.
- (4) Press ㊂ ㊂ to display "FINE" on the screen.
- (5) Press + or - continuously until the above problems are minimized.
The + or - icon on the screen flashes while tuning.
- (6) Press SELECT to return to normal screen.

Watching the TV

This section explains functions used while watching the TV. Most operations can be done using the remote.

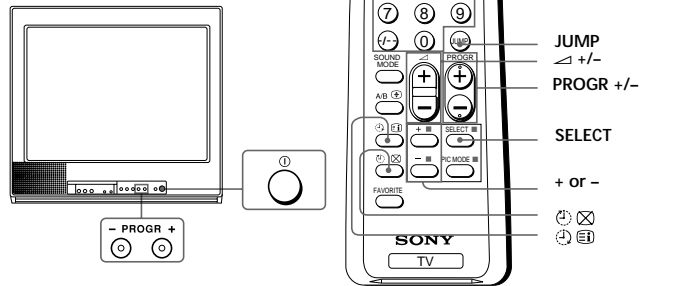

1 Press to turn on the TV.

When the TV is in the standby mode (the on the TV is lit red), press on the remote or PROGR +/- on the TV.



2 Press PROGR +/- or the number buttons to select the TV program.

For double digit numbers, press +/-, then the number (e.g., for 25, press +/-, then 2 and 5).

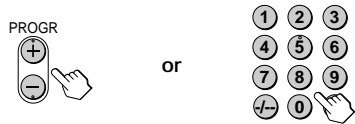

3 Press to adjust the volume.



Watching the TV (continued)

Additional tasks

To	Do this
Turn off temporarily	Press . The on the TV lights up red.
Turn off completely	Press on the TV.
Mute the sound	Press .
Watch the video input (VCR, camcorder, etc.)	Press to select "VIDEO 1" or "VIDEO 2". To return to the TV program, press .
Jump back to the previous channel	Press JUMP.
Display the on-screen information*	Press .
Adjust the volume of each TV program automatically	Press SELECT repeatedly until "INTELLIGENT VOL" appears, then press + or - to select "ON". To cancel, select "OFF".

* The picture, sound, and either the program number or video mode are displayed. The on-screen display for the picture and sound information disappears after about 3 seconds.

Changing the on-screen display language (Except KV-PF21L70/PF21M70(ME)/PF21Q70)

1 Press SELECT until "LANGUAGE / 语言: ENGLISH" appears on the screen.



2 Press + or - to select "中文".

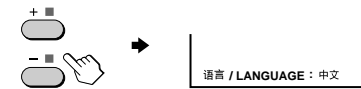

Tip

- You can also use SELECT and +/- on the TV to select the on-screen display language.

continued

Watching the TV (continued)

Changing the on-screen display language
 (KV-PF21L70/PF21M70(ME)/PF21Q70)

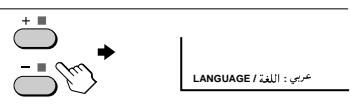
- 1 Press SELECT until "LANGUAGE / اللغة : ENGLISH" appears on the screen.
 
- 2 Press + or - to select "عربي".
 

Tip

- You can also use SELECT and \triangleleft +/ - on the TV to select the on-screen display language.

Setting the Wake Up timer

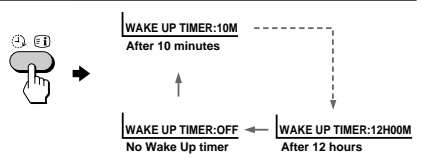
- 1 Press \odot Ⓜ until the desired period of time appears.
 
- 2 Select the TV program or video mode you want to display when you wake up.
- 3 Press ⏻ or set the Sleep timer if you want the TV to turn off automatically.

The \odot indicator on the TV lights up orange.

To cancel the Wake Up timer

Press \odot Ⓜ until "WAKE UP TIMER: OFF" appears or turn off the TV's main power.

- Notes**
- The Wake Up timer starts immediately after the on-screen display disappears.
 - If no buttons or controls are pressed for more than two hours after the TV is turned on using the Wake Up timer, the TV automatically goes into the standby mode. To continue watching the TV, press any button or control on the TV or the remote.

Setting the Sleep timer

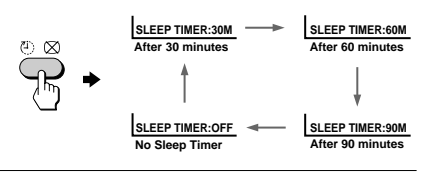
- Press \odot Ⓜ until the desired period of time appears.
- 

To cancel the Sleep timer

Press \odot Ⓜ until "SLEEP TIMER: OFF" appears or turn the TV off.

Advanced Operations

Customizing the picture and sound

You can customize the picture and sound by selecting the picture and sound modes or by adjusting its settings.

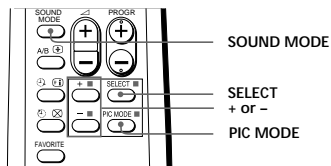

Selecting the picture and sound modes

To select the picture mode

Press PIC MODE repeatedly until you get the desired picture mode.

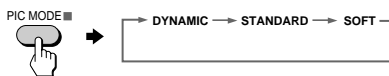

Select	To
DYNAMIC	receive high contrast pictures.
STANDARD	receive normal contrast pictures.
SOFT	receive mild pictures.

To select the sound mode

Press SOUND MODE repeatedly until you get the desired sound mode.



Select	To
DYNAMIC	listen to dynamic and clear sound that emphasizes the low and high sound.
DRAMA	listen to sound that emphasizes vocals and background music.
SOFT	receive soft sound.

Adjusting the picture and sound settings

- 1 Press SELECT until the desired setting appears.



Each time you press SELECT, the setting item will change as follows:



- 2 Press + or - to adjust the item.



- 3 To adjust other items, repeat steps 1 to 2.

* "HUE" can be adjusted for the NTSC system only.

Notes

- When you select a picture or sound mode, the adjusted settings will be reset according to the selected mode.
- You can also use SELECT and +/- on the TV to adjust the picture and sound settings.

Blocking the channels (CHILD LOCK)

You can prevent a child from watching certain programs by using the buttons on the remote control.

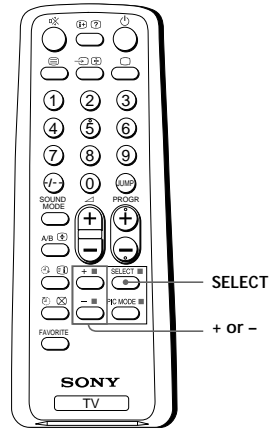



1 Select the TV program you want to lock.

2 Press SELECT until "CHILD LOCK" appears on the screen.



3 Press + or - to select "ON".

The  symbol appears on the screen.

To unlock the channel, press + or - to select "OFF". The  symbol disappears from the screen.

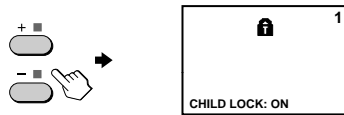

Note

- If you preset a locked channel, that particular channel will be unlocked automatically.

Viewing Teletext

(KV-PF21P41 only)

TV stations broadcast an information service called Teletext via some TV channels. Teletext allows you to receive various information, such as shares market or news.

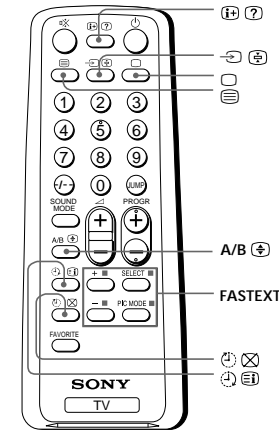

Displaying Teletext

1 Select a TV channel that carries the Teletext broadcast you want to watch.

2 Press  to display the text.

A Teletext page (normally the index page) is displayed. If there is no Teletext broadcast, "100" is displayed at the top left corner of the screen.

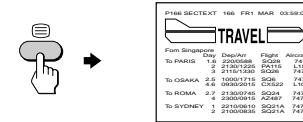

To turn off Teletext

Press .

continued

Viewing Teletext (continued)

Additional Teletext tasks

To	Do this
display a Teletext page on the TV picture	Press . Each time you press , the screen changes as follows: Teletext → Teletext and TV → TV.
check the contents of a Teletext service	Press . An overview of the Teletext contents and page numbers appear on the screen.
select a Teletext page	Press the number buttons to enter the three-digit page number of the desired Teletext page.* If you make a mistake, reenter the correct page number. To access the next or previous page, press PROGR +/-.
hold a Teletext page (stop the page from scrolling)	Press to display the symbol “” at the top left corner of the screen. To resume normal Teletext operation, press or .
reveal concealed information (e.g., an answer to a quiz)	Press . To conceal the information, press the button again.
enlarge the Teletext display	Press A/B . Each time you press A/B , the Teletext display changes as follows: Enlarge upper half → Enlarge lower half → Normal size.
wait for a Teletext page while watching a TV program	1 Enter the Teletext page number that you want to refer to, then press .
	2 When the page number is displayed, press to show the text.

* You can also select a Teletext page of any page number that appears in the colored column at the bottom of the screen using the corresponding color-coded button on the remote.

Using FASTEXT

This feature allows you to quickly access a Teletext page that uses FASTEXT. When a FASTEXT program is broadcasted, the colored menus appear at the bottom of the screen. The colors of the menus correspond to the red, green, yellow, and blue color-coded buttons on the remote.

To access a FASTEXT menu

Press the color-coded button on the remote corresponding to the menu you want. The menu page appears on the screen after several seconds.

Additional Information

Self-diagnosis function

Your TV is equipped with a self-diagnosis function. If there is a problem with your TV, the indicator flashes red. The number of times the indicator flashes indicates the possible causes.

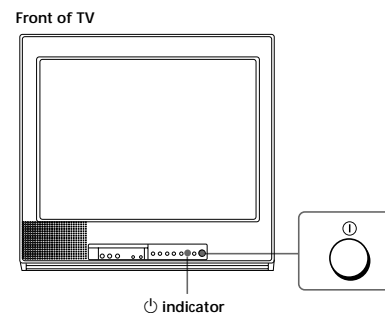

- 1 Check that the indicator flashes red a number of times between 3-second intervals.
- 2 Count the number of times the indicator flashes.
- 3 Press (main power) to turn off your TV.
- 4 Inform your nearest Sony service center about the number of times the indicator flashes.
Be sure to note the model name and serial number located on the rear of your TV.

Troubleshooting Shortcuts

For better viewing, please check the following connections.

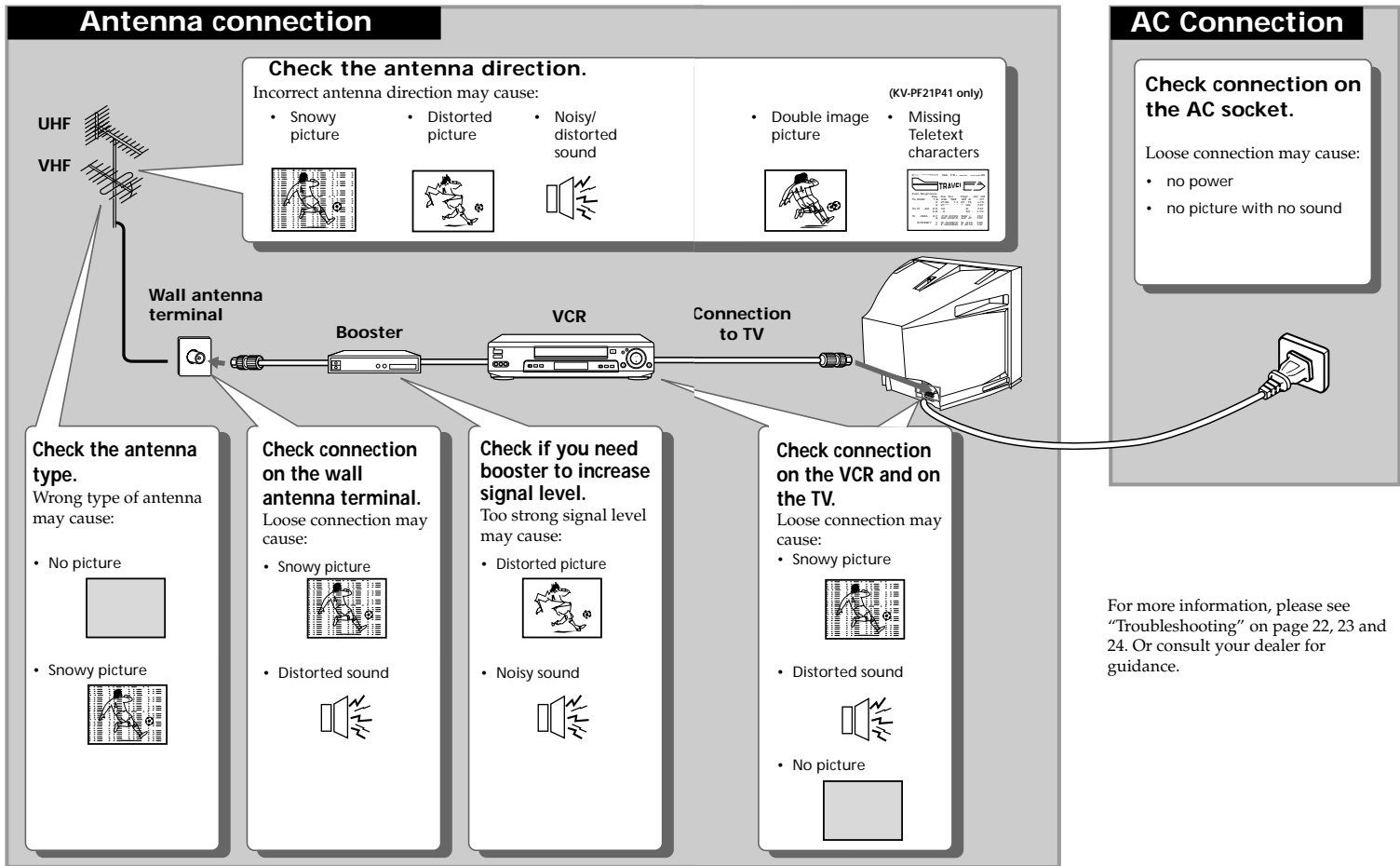









For more information, please see "Troubleshooting" on page 22, 23 and 24. Or consult your dealer for guidance.

Additional Information

Troubleshooting

(KV-PF21L70/PF21M70(ME)/PF21Q70)









If you find any problem while viewing your TV, please check the following guide. If any problem persists, contact your Sony dealer .

Symptom	Solutions	Possible cause
Snowy picture 	<ul style="list-style-type: none"> Check the antenna cable and connection on the TV, VCR and on the wall. (page 4) Press SELECT until "MANUAL PROGRAM" appears on the screen then preset the channel again. (page 9) 	<ul style="list-style-type: none"> Connection is loose or the cable is damaged. Channel presetting is inappropriate or incomplete.
Noisy sound 	<ul style="list-style-type: none"> Check the antenna type (VHF/UHF). Contact a Sony dealer for advice. Adjust the antenna direction. Contact a Sony dealer for advice. Try using a booster. 	<ul style="list-style-type: none"> The antenna type is inappropriate. The antenna direction is inappropriate. Signal transmission is low.
Distorted picture 	<ul style="list-style-type: none"> Turn off or disconnect the booster if it is in use. 	<ul style="list-style-type: none"> Broadcast signals are too strong.
Noisy sound 		
Good picture 	<ul style="list-style-type: none"> If the sound of some channels are noisy, select the channel, then select the appropriate TV system (TV SYS). (page 10) 	<ul style="list-style-type: none"> The TV system setting is inappropriate.
Noisy sound 		
No picture 	<ul style="list-style-type: none"> Check the power cord, antenna and the VCR connections. Press ⏻ (power). Press ⏻ (main power) on the TV to turn off the TV for about five seconds, then turn it on again. 	<ul style="list-style-type: none"> The power cord, antenna or VCR is not connected. The TV is not turned on.
No sound 		

Troubleshooting

(KV-PF21M40/PF21M70(E))

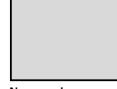





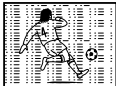

If you find any problem while viewing your TV, please check the following guide. If any problem persists, contact your Sony dealer .

Symptom	Solutions	Possible cause
Snowy picture 	<ul style="list-style-type: none"> Check the antenna cable and connection on the TV, VCR and on the wall. (page 4) Press SELECT until "MANUAL PROGRAM" appears on the screen then preset the channel again. (page 9) 	<ul style="list-style-type: none"> Connection is loose or the cable is damaged. Channel presetting is inappropriate or incomplete.
Noisy sound 	<ul style="list-style-type: none"> Check the antenna type (VHF/UHF). Contact a Sony dealer for advice. Adjust the antenna direction. Contact a Sony dealer for advice. Try using a booster. 	<ul style="list-style-type: none"> The antenna type is inappropriate. The antenna direction is inappropriate. Signal transmission is low.
Distorted picture 	<ul style="list-style-type: none"> Turn off or disconnect the booster if it is in use. 	<ul style="list-style-type: none"> Broadcast signals are too strong.
Noisy sound 		
Good picture 	<ul style="list-style-type: none"> If the sound of all the channels are noisy, check the TV system (TV SYS) setting (page 10), then press AUTO PROGR to preset the channels again (page 8). If the sound of some channels are noisy, select the channel, then select the appropriate TV system (TV SYS). (page 10) 	<ul style="list-style-type: none"> The TV system setting or channel presetting is inappropriate or incomplete.
Noisy sound 		
No picture 	<ul style="list-style-type: none"> Check the power cord, antenna and the VCR connections. Press ⏻ (power). Press ⏻ (main power) on the TV to turn off the TV for about five seconds, then turn it on again. 	<ul style="list-style-type: none"> The power cord, antenna or VCR is not connected. The TV is not turned on.
No sound 		

Troubleshooting

(KV-PF21P10)







If you find any problem while viewing your TV, please check the following guide. If any problem persists, contact your Sony dealer .







Symptom	Solutions	Possible cause
Snowy picture 	<ul style="list-style-type: none"> Check the antenna cable and connection on the TV, VCR and on the wall. (page 4) Press SELECT until "MANUAL PROGRAM" appears on the screen then preset the channel again. (page 9) 	<ul style="list-style-type: none"> Connection is loose or the cable is damaged. Channel presetting is inappropriate or incomplete.
Noisy sound 	<ul style="list-style-type: none"> Check the antenna type (VHF/UHF). Contact a Sony dealer for advice. Adjust the antenna direction. Contact a Sony dealer for advice. Try using a booster. 	<ul style="list-style-type: none"> The antenna type is inappropriate. The antenna direction is inappropriate. Signal transmission is low.
Distorted picture 	<ul style="list-style-type: none"> Turn off or disconnect the booster if it is in use. 	<ul style="list-style-type: none"> Broadcast signals are too strong.
Noisy sound 		
Good picture 	<ul style="list-style-type: none"> If the sound of all the channels are noisy, press AUTO PROGR to preset the channels again (page 8). 	<ul style="list-style-type: none"> Channel presetting is inappropriate or incomplete.
Noisy sound 		
No picture 	<ul style="list-style-type: none"> Check the power cord, antenna and the VCR connections. Press ⏻ (power). Press ⏻ (main power) on the TV to turn off the TV for about five seconds, then turn it on again. 	<ul style="list-style-type: none"> The power cord, antenna or VCR is not connected. The TV is not turned on.
No sound 		

Troubleshooting

(KV-PF21P40/PF21P41)

If you find any problem while viewing your TV, please check the following guide. If any problem persists, contact your Sony dealer .

Symptom	Solutions	Possible cause
Snowy picture 	<ul style="list-style-type: none"> Check the antenna cable and connection on the TV, VCR and on the wall. (page 4) Press SELECT until "MANUAL PROGRAM" appears on the screen then preset the channel again. (page 9) 	<ul style="list-style-type: none"> Connection is loose or the cable is damaged. Channel presetting is inappropriate or incomplete.
Noisy sound 	<ul style="list-style-type: none"> Check the antenna type (VHF/UHF). Contact a Sony dealer for advice. Adjust the antenna direction. Contact a Sony dealer for advice. Try using a booster. 	<ul style="list-style-type: none"> The antenna type is inappropriate. The antenna direction is inappropriate. Signal transmission is low.
Distorted picture 	<ul style="list-style-type: none"> Turn off or disconnect the booster if it is in use. 	<ul style="list-style-type: none"> Broadcast signals are too strong.
Noisy sound 		
No picture 	<ul style="list-style-type: none"> Check the power cord, antenna and the VCR connections. Press ⏻ (power). Press ⏻ (main power) on the TV to turn off the TV for about five seconds, then turn it on again. 	<ul style="list-style-type: none"> The power cord, antenna or VCR is not connected. The TV is not turned on.
No sound 		

Symptom	Solutions	Possible cause
Good picture 	<ul style="list-style-type: none"> Press \triangleleft + to increase the volume level. Press \otimes to cancel the muting. 	<ul style="list-style-type: none"> The volume level is too low. The sound is muted.
No sound 		
Dotted lines or stripes 	<ul style="list-style-type: none"> Do not use a hair dryer or other equipment near the TV. Adjust the antenna direction for minimum interference. Contact a Sony dealer for advice. 	<ul style="list-style-type: none"> There is local interference from cars, neon signs, hair dryers, power generators, etc.
Double images or "ghosts" 	<ul style="list-style-type: none"> Use a highly directional antenna. Use the fine tuning (FINE) function. (page 10) Adjust the antenna direction. Contact a Sony dealer for advice. Turn off or disconnect the booster if it is in use. 	<ul style="list-style-type: none"> Broadcast signals are reflected by nearby mountains or buildings. The antenna direction is inappropriate. Use of a booster is inappropriate.
No color 	<ul style="list-style-type: none"> Press SELECT until "COLOR" appears on the screen, then press + or - to adjust the color level. (page 15) Press SELECT until "COL SYS" appears on the screen, then check the color system setting (usually set this to "AUTO"). (page 9). Adjust the antenna direction. Contact a Sony dealer for advice. 	<ul style="list-style-type: none"> The color level setting is too low. The color system setting is inappropriate. The antenna direction is inappropriate.
Abnormal color patches 	<ul style="list-style-type: none"> Keep external speakers or other electrical equipment away from the TV. Do not move the TV while the TV is turned on. Press O (main power) on the TV to turn off the TV for about five minutes, then turn it on again. 	<ul style="list-style-type: none"> The magnetic disturbance from external speakers or other equipment, or the direction of the earth's magnetic field may affect the TV.

Troubleshooting (continued)

Symptom	Solutions	Possible cause
Lines moving across the TV screen.	<ul style="list-style-type: none"> Use the fine tuning (FINE) function. (page 10) 	<ul style="list-style-type: none"> There is interference from external sources, e.g., heavy machineries, nearby broadcast station.
The O indicator on your TV flashes red a number of times between 3-second intervals.	<ul style="list-style-type: none"> Contact your nearest Sony service center. (page 19) 	<ul style="list-style-type: none"> Your TV may need service.
TV cabinet creaks.	—	<ul style="list-style-type: none"> Changes in room temperature sometimes make the TV cabinet expand or contract, making a noise. This does not indicate a malfunction.
A "boom" sound is heard when the TV is turned on.	—	<ul style="list-style-type: none"> The TV's demagnetizing function is working. This does not indicate a malfunction.

continued

Identifying parts and controls

Refer to the pages indicated in parentheses () for details.

Front panel

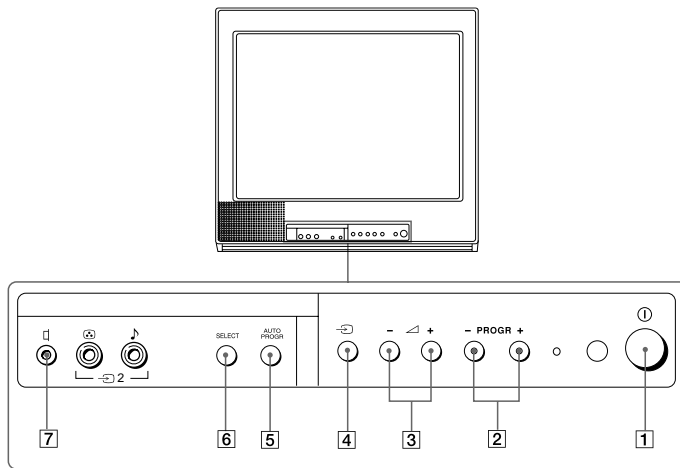

- 1 ① (main power) button (5)
- 2 PROGR +/- (program) buttons (11)
- 3 +/- (volume) buttons (11)
- 4 TV/video button (12)
- 5 AUTO PROGR (program) button (5)
- 6 SELECT button (9)
- 7 (earphone) jack

Remote Control

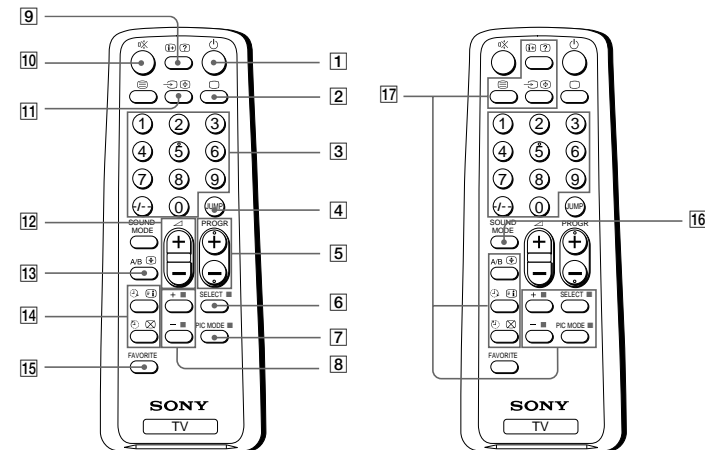

- 1 ① (power) button (11)
- 2 □ (TV) button (12)
- 3 Number buttons (11)
- 4 JUMP button (12)
- 5 PROGR +/- buttons (11)
- 6 SELECT button (9)
- 7 PIC MODE button (14)
- 8 + or - buttons (9)
- 9 (display) button (12)
- 10 ✖ (muting) button (12)
- 11 (video) button (12)
- 12 +/- (volume) buttons (11)
- 13 A/B button
(not used for these models)
- 14 Timer setting buttons (13)
⌚ (wake up timer)
⌚ (sleep timer)
- 15 FAVORITE button
(not used for these models)

- 16 SOUND MODE button (14)
- 17 Teletext operation buttons (17)
(KV-PF21P41 only)
☰ (text) ⊕ (enlarge)
⊙ (reveal) ⊗ (hold)
⊞ (index) ⊗ (text clear)
■ (FASTEXT: red, green, yellow, blue)

Names/symbols of buttons on the remote are indicated in different colors to represent the available functions.

Label color	Button function
White	For general TV operations
Green	For Teletext operations

SECTION 2 DISASSEMBLY

2-1. REAR COVER REMOVAL

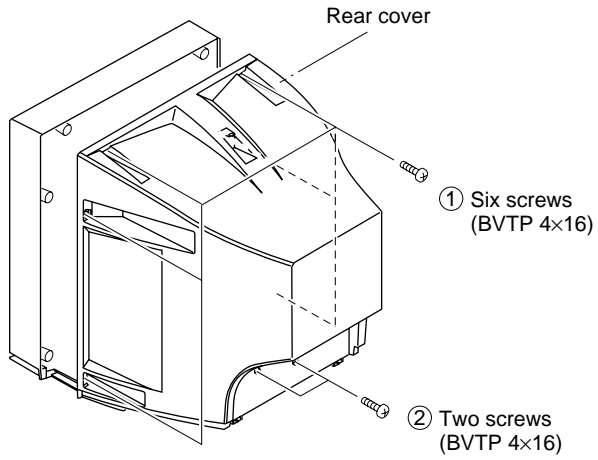

2-2. CHASSIS ASSY REMOVAL

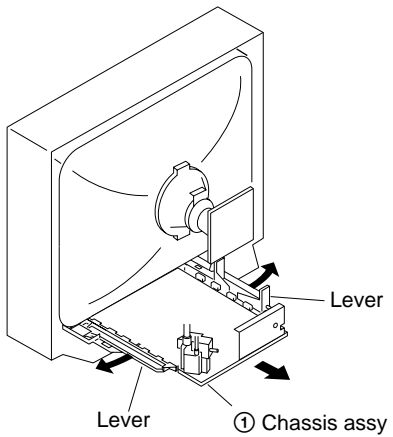

2-3. F BRACKET REMOVAL

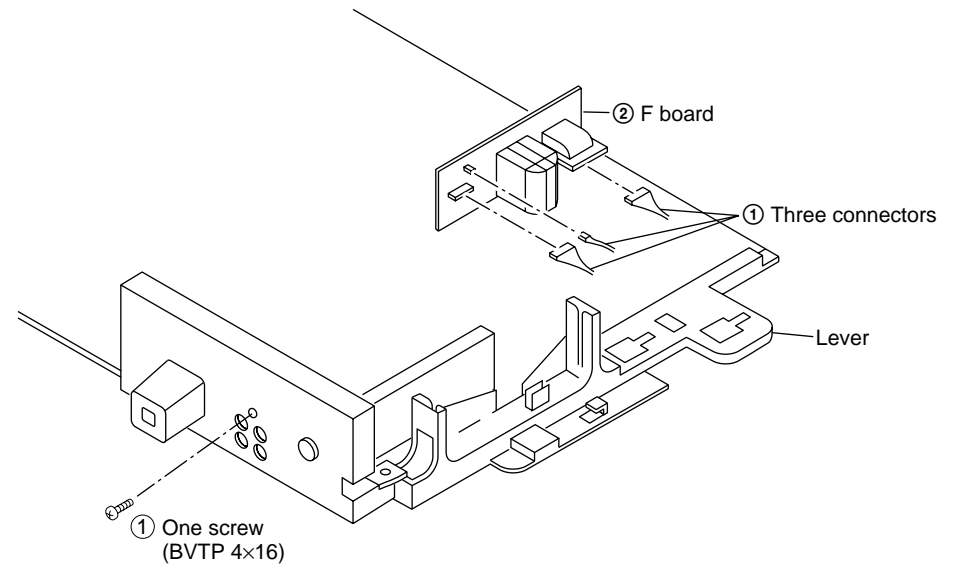

2-4. SERVICE POSITION

(Note: Remove F Bracket first.)

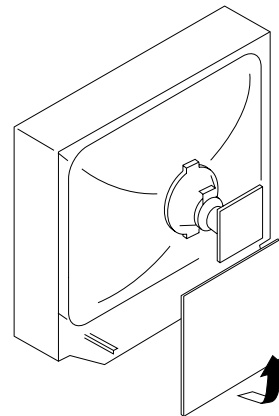

2-5. REPLACEMENT OF PARTS

For replacement of the Multi Button and Bar Optical ,unscrew to exchange with the new parts, and fix them with screws (+BVTP) respectively.

2-5-1. REPLACEMENT OF MULTI BUTTON

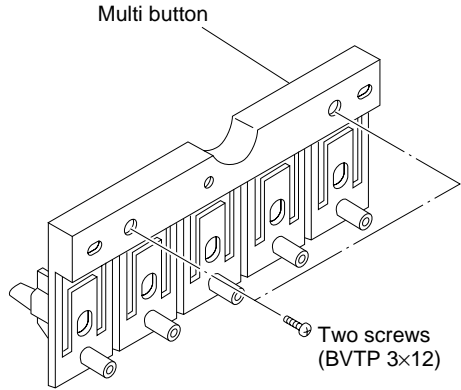

2-5-2. REPLACEMENT OF BAR OPTICAL

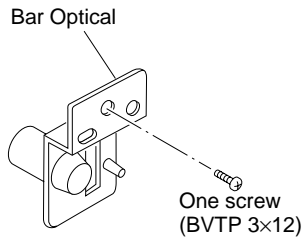

2-6. TERMINAL BRACKET REMOVAL

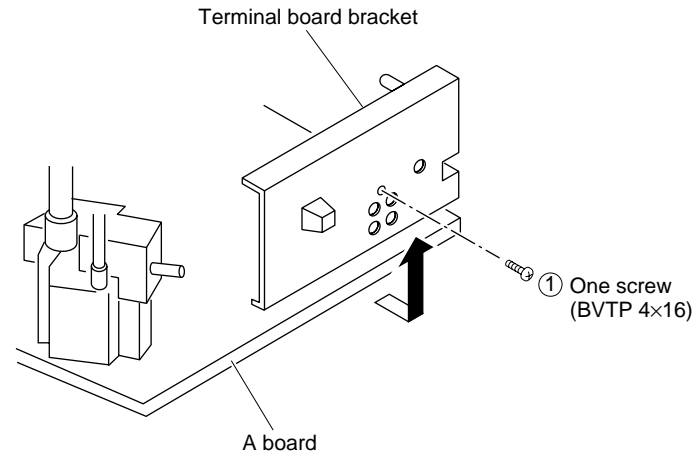

2-7. V1 BOARD REMOVAL

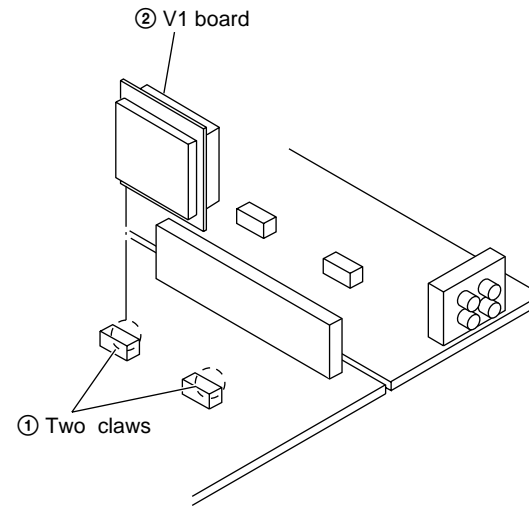

2-8. DEGAUSS COIL REMOVAL

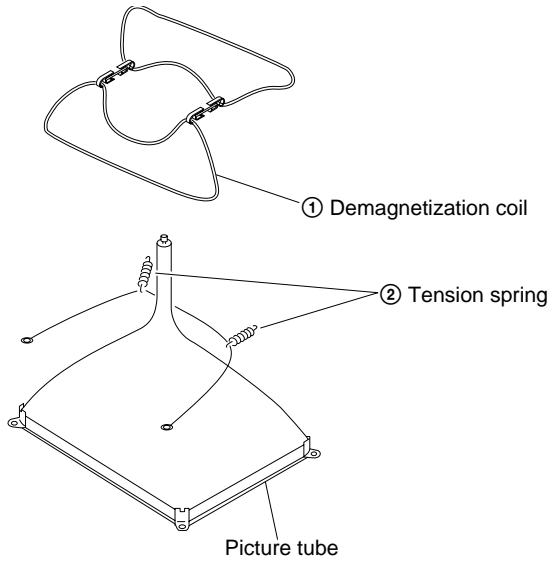

2-9. PICTURE TUBE REMOVAL

NOTE : The picture tube for OCE model is upside down, and the position for the anode cap and tension springs are changed accordingly.

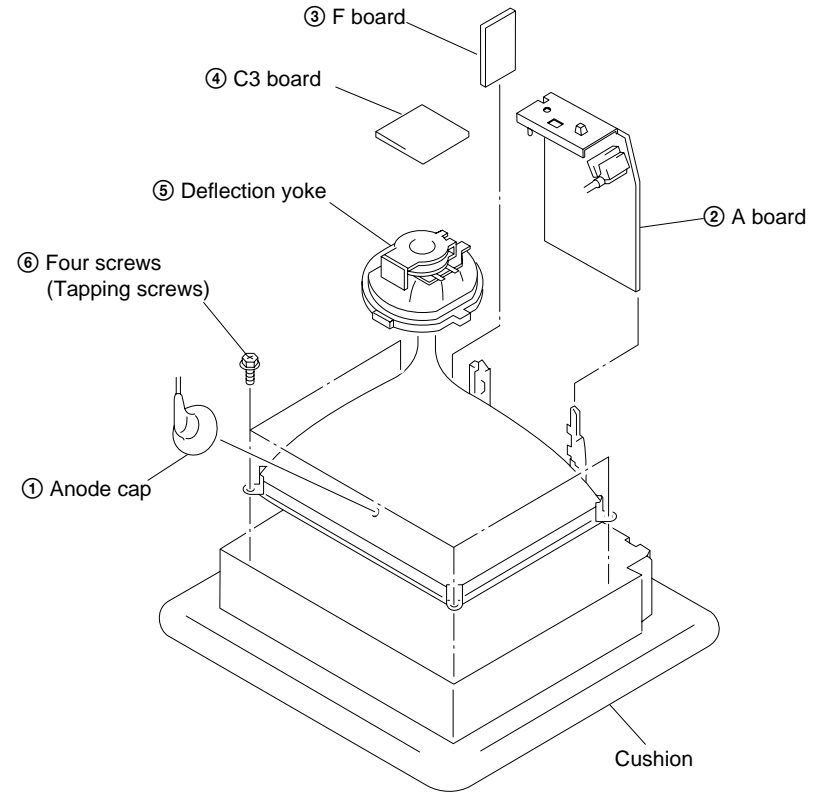

•REMOVAL OF ANODE-CAP

NOTE : After removing the anode, short circuit the anode of the picture tube and the anode cap to the metal chassis, CRT shield or carbon paint on the CRT.

•REMOVING PROCEDURES

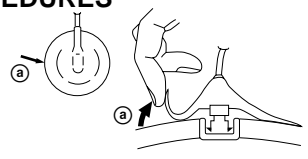

① Turn up one side of the rubber cap in the direction indicated by the arrow ①.

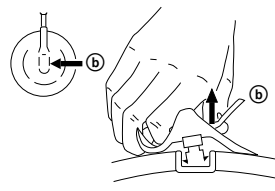

② Using a thumb pull up the rubber cap firmly in the direction indicated by the arrow ②.

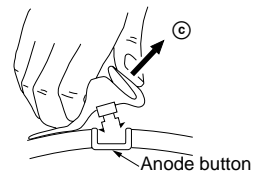

③ When one side of the rubber cap is separated from the anode button, the anode-cap can be removed by turning up the rubber cap and pulling it up in the direction of the arrow ③.

• HOW TO HANDLE AN ANODE-CAP

- ① Do not damage the surface of anode-caps with sharp shaped objects.
- ② Do not press the rubber too hard so as not to damage the inside of anode-cap. A metal fitting called the shatter-hook terminal is built into the rubber.
- ③ Do not turn the foot of rubber over too hard. The shatter-hook terminal will stick out or damage the rubber.

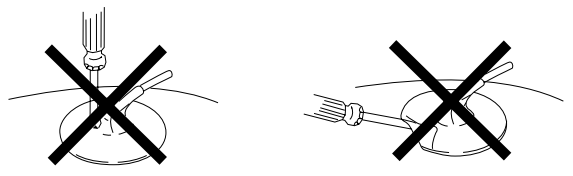

SECTION 3 SET-UP ADJUSTMENTS

- The following adjustments should be made when a complete realignment is required or a new picture tube is installed.
- These adjustments should be performed with rated power supply voltage unless otherwise noted.

Controls and switches should be set as follows unless otherwise noted:

PICTURE control normal
BRIGHTNESS control normal

Perform the adjustments in the following order :

1. Beam Landing
2. Convergence
3. Focus
4. White Balance

Note : Test Equipment Required.

1. Color-bar/Pattern Generator
2. Degausser
3. Oscilloscope

Preparation :

- In order to reduce the influence of geomagnetism on the set's picture tube, face it east or west.
- Switch on the set's power and degauss with the degausser.

3-1. BEAM LANDING

1. Input a white signal with the pattern generator.

Contrast } normal
Brightness }

2. Set the pattern generator raster signal to a green raster.
3. Move the deflection yoke to the rear and adjust with the purity control so that the green is at the center and the blue and the red take up equally sized areas on each side.
(See Figures 3-1 through 3-3.)
4. Move the deflection yoke forward and adjust so that the entire screen is green. (See Figure 3-1.)
5. Switch the raster signal to blue, then to red and verify the condition.
6. When the position of the deflection yoke has been decided, fasten the deflection yoke with the screws and DY spacers.
7. If the beam does not land correctly in all the corners, use a magnet to adjust it.
(See Figure 3-4.)

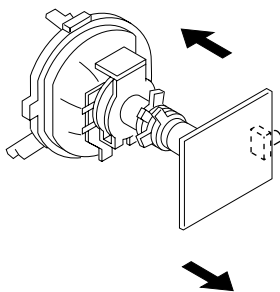

Fig. 3-1

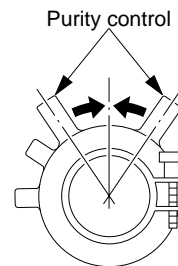

Fig. 3-2

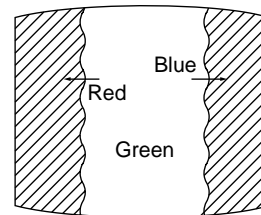

Fig. 3-3

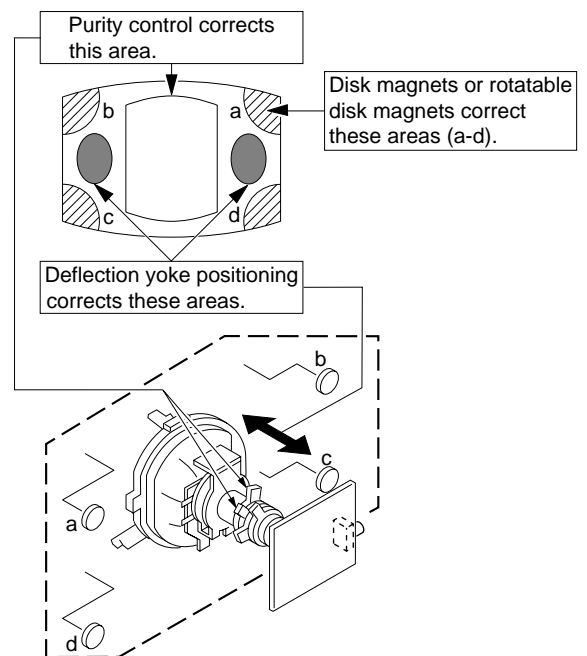

Fig. 3-4

3-2. CONVERGENCE

Preparation :

- Before starting this adjustment, adjust the focus, horizontal size and vertical size.
- Minimize the brightness setting.
- Provide dot pattern.

(1) Horizontal and Vertical Static Convergence

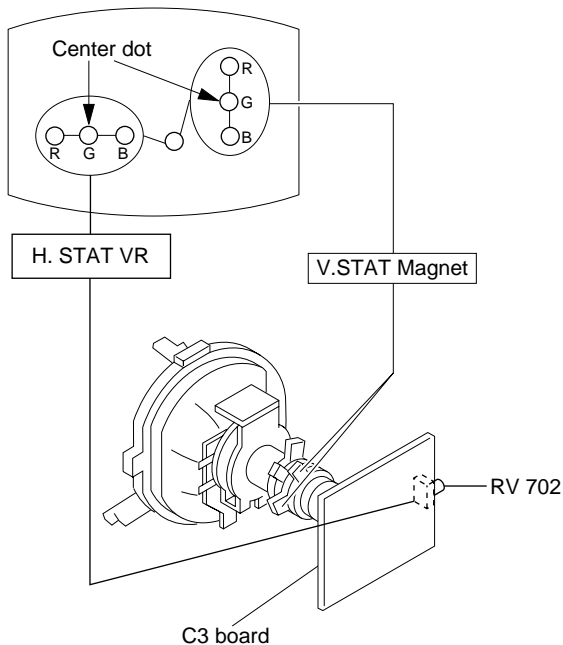

(Moving vertically), adjust the V.STAT magnet so that the red, green and blue dots are on top of each other at the center of the screen.

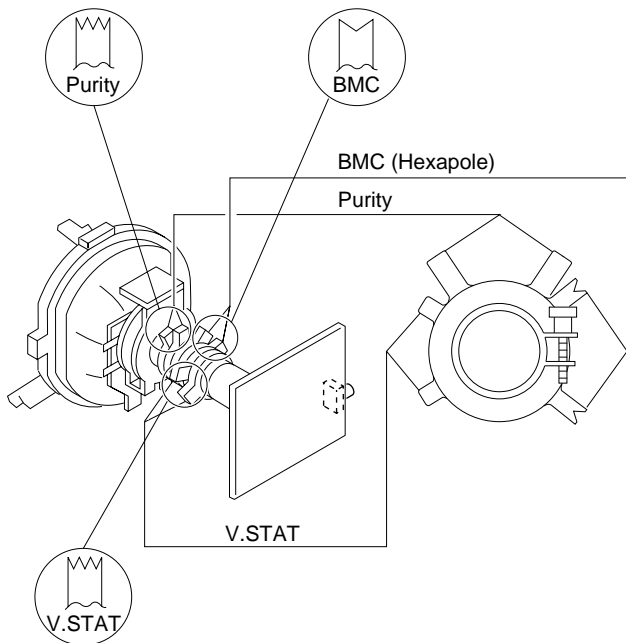

① V. STAT

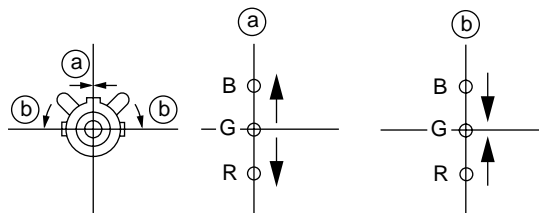

② H. STAT VR

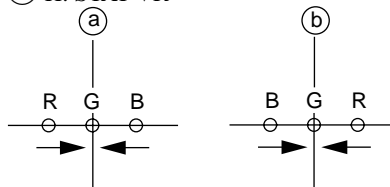

③

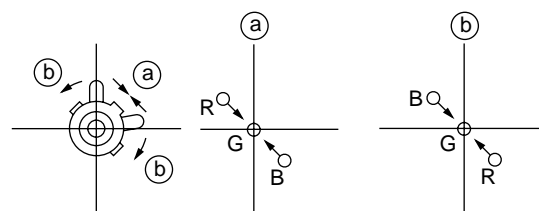

④ BMC (Hexapole) Magnet.

If the red, green and blue dots are not balanced or aligned, then use the BMC magnet to adjust in the manner described below.

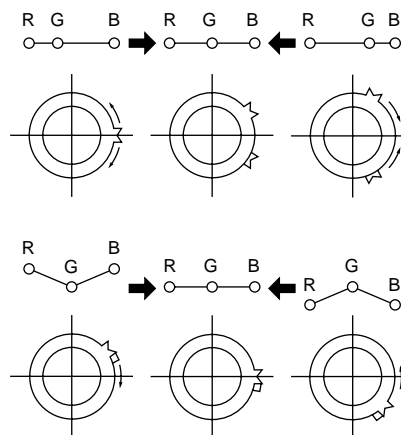

(2) Dynamic Convergence Adjustment

Preparation:

- Before starting this adjustment, adjust the horizontal static convergence and the vertical static convergence

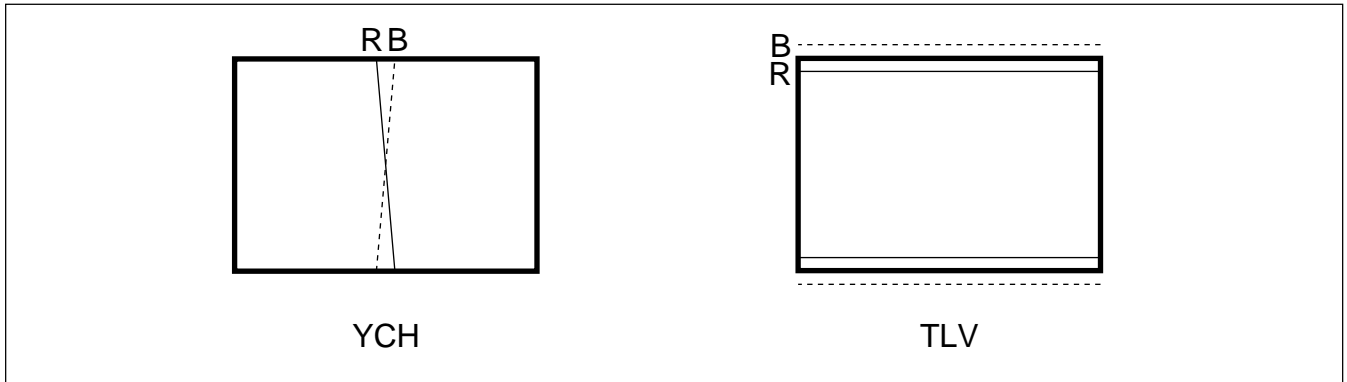

on DY

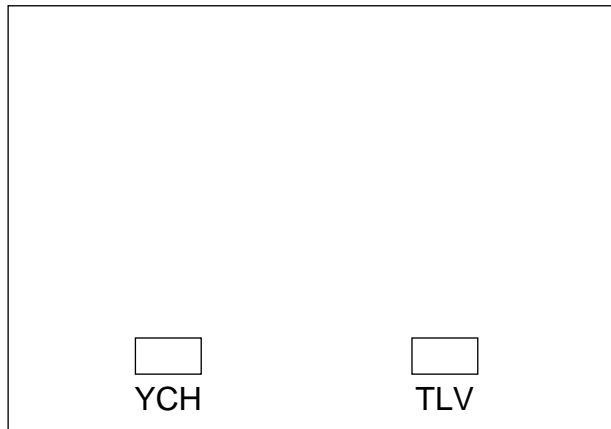

(3) Screen-corner Convergence

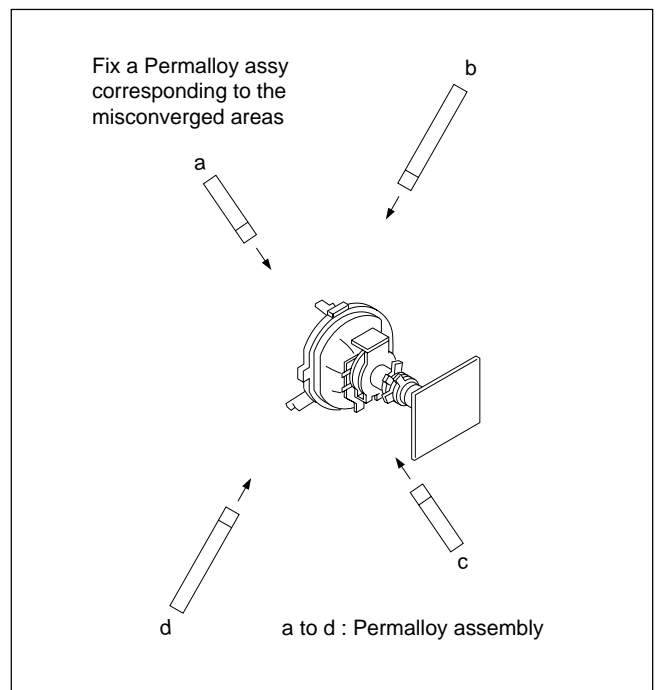
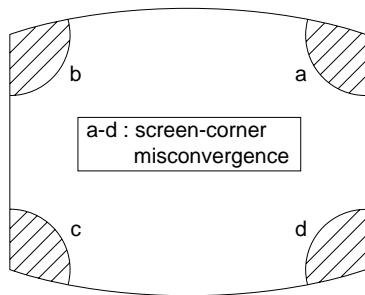

3-3. FOCUS ADJUSTMENT

Adjust FOCUS control on the flyback transformer for the best focus.

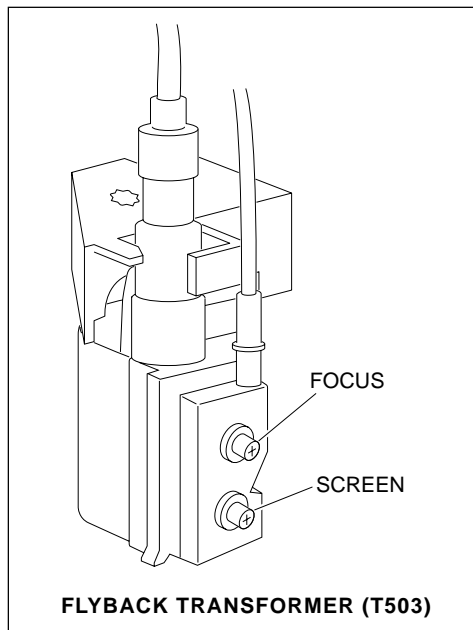

3-4. G2 (SCREEN) AND WHITE BALANCE ADJUSTMENTS

1. G2 (SCREEN) ADJUSTMENT

- 1) Set the PICTURE to normal.
- 2) Put to VIDEO input mode without signals.
- 3) Connect R, G and B of the C3 board cathode to the oscilloscope.
- 4) Adjust BRIGHTNESS to obtain the cathode voltage to the value below.
- 5) Adjust G2 (Screen) on FBT until picture shows the point before cut-off.

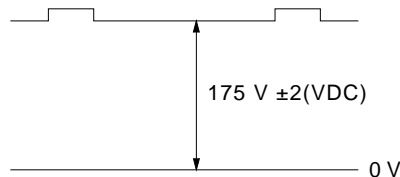

2. WHITE BALANCE ADJUSTMENT

- 1) Set to Service Mode (Refer Section 4-1: ADJUSTMENTS WITH COMMANDER).
- 2) Input white raster signal.
- 3) Set the PICTURE to minimum.
- 4) Select GCT (WHB 4) and BCT (WHB 5) with [1] and [4], and adjust the level with [3] and [6] for the best white balance.
- 5) Set the PICTURE to maximum.
- 6) Select GDR (WHB 1) and BDR (WHB 2) with [1] and [4], and adjust the level with [3] and [6] for the best white balance.
- 7) Write into the memory by pressing [MUTING] then [0].

3. SUB BRIGHT ADJUSTMENT

- 1) Set to service mode.
- 2) Input a staircase signal of black to white from the pattern generator.
- 3) BRIGHTNESS 50%.
 PICTURE MINIMUM
- 4) Select SBR (WHB7) with [1] and [4], and adjust SBR (WHB7) level with [3] and [6] so that the second stripe from the right is dimly lit.

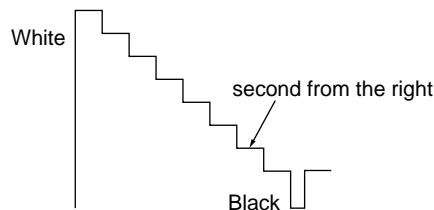

SECTION 4 CIRCUIT ADJUSTMENTS

4-1. ADJUSTMENTS WITH COMMANDER

Service adjustments are made with the RM-952 that comes with this unit.

a. ENTERING SERVICE MODE

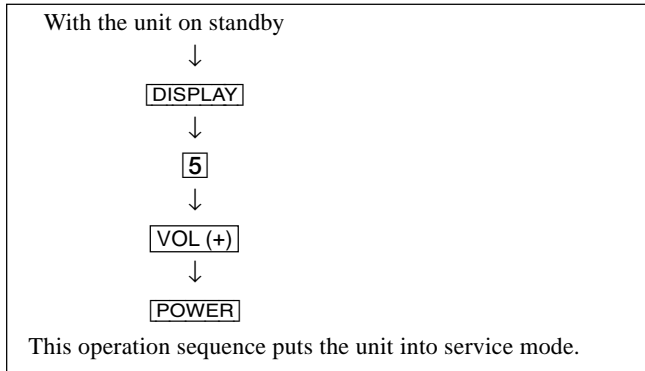

b. METHOD OF CANCELLATION FROM SERVICE MODE

Set the standby condition (Press **POWER** button on the commander), then press **POWER** button again, hereupon it becomes TV mode.

c. METHOD OF WRITE INTO MEMORY

- 1) Set to Service Mode.
- 2) Press **1** (UP) and **4** (DOWN), select an item of adjustment.
- 3) Press **MUTING** button and it will indicate WRITE on the screen.
- 4) Press **0** button to write into memory.

d. MEMORY WRITE CONFIRMATION METHOD

- 1) After adjustment, pull out the plug from AC outlet, and then plug into AC outlet again.
- 2) Turn the power switch ON and set to Service Mode.
- 3) Call the adjusted items again to confirm adjustments were made.

The screen display is :

Device Name	Item Name	Marking of virgin NVM		Mode	
	Item No	Data			
GEO	00	HPS	1C	■	SERVICE 50 ←
623S or 622S	1.0C	59	7F	0	000A
Suffix No (OEM Code)	Software version	Total Power-On time (hours)			

PAL, SECAM : 50
NTSC : 60

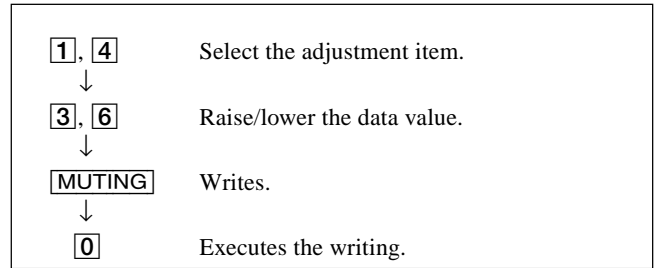

7, 0

All the data becomes the values in memory.

8, 0

All user control goes to the standard state.

5, 0

Service data initialization (Be sure not to use usually.)

2, 0

Write 50Hz adjustment data to 60Hz, or vice versa.

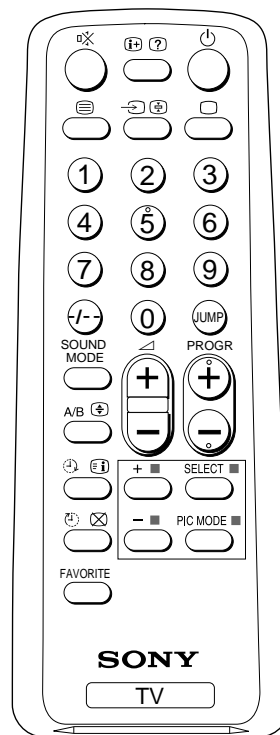

RM-952

4-2. ADJUSTMENT METHOD

Item Number 00 of device GEO

This explanation uses H-Position as an example.

1. Select "GEO 00 HPS" with the **[1]** and **[4]** buttons.
2. Raise/lower the data with the **[3]** and **[6]** buttons.
3. Select the optimum state. (The standard is 1F for PAL reception.)
4. Write with the **[MUTING]** button. (The display changes to WRITE.)
5. Execute the writing with the **[0]** button. (The WRITE display will be changed to red color while excuting, and back to SERVICE.)

Use the same method for all Items. Use **[1]** and **[4]** to select the adjustment item, use **[3]** and **[6]** to adjust, write with **[MUTING]**, then execute the write with **[0]**.

- Note :**
1. In **[WRITE]**, the data for all items are written into memory together.
 2. For adjustment items that have different standard data between 50Hz or 60Hz, be sure to use the respective input signal after adjustment.

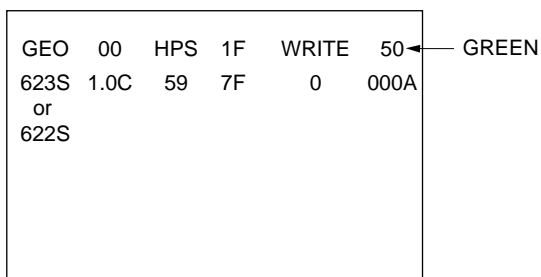
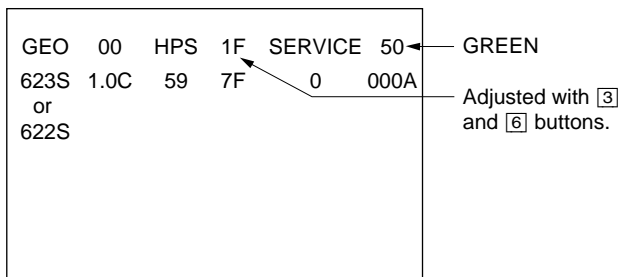

Written with **[MUTING]**

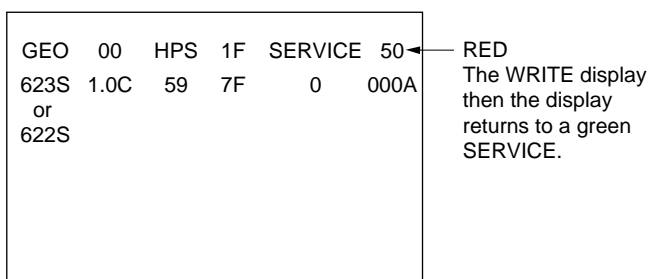

Write executed with **[0]**

Adjustment Item Table

Category	Functionality		Micro Init	Data Range	Function	Note for Different Data	Register No. (bit)	Slave Address	RAM Address (bit)
	No.	Name							
GEO	0	HPS	7	3F	H Position	50/60HZ	12 (7-2)	CXA2130S(88H)	82 (7-2)
	1	HSZ	1F	3F	H Size	50/60HZ	11 (7-2)		81 (7-2)
	2	PAP	1F	3F	Pin Amp	50/60HZ	13 (7-2)		83 (7-2)
	3	TLT	7	0F	Trapezium	50/60HZ	15 (7-4)		85 (7-4)
	4	VPS	1F	3F	V Position	50/60HZ	0F (7-2)		7F (7-2)
	5	VSZ	1F	3F	V Size	50/60HZ	0E (7-2)		7E (7-2)
	6	SCO	7	0F	S Correction	50/60HZ	10 (7-4)		80 (7-4)
	7	VLN	7	0F	V Linearity	50/60HZ	10 (3-0)		80 (3-0)
	8	BOW	7	0F	AFC Bow	50/60HZ	16 (7-4)		86 (7-4)
	9	AGL	7	0F	AFC-Angle	50/60HZ	16 (3-0)		86 (3-0)
	10	UPN	1F	3F	Upper Pin	50/60HZ	14 (7-2)		84 (7-2)
	11	LPN	1F	3F	Lower Pin	50/60HZ	18 (7-2)		88 (7-2)
	12	HBL	0	1	H Blanking on/off		18 (1)		67 (1)
	13	LBL	7	0F	Left H Blanking	50/60HZ	17 (7-4)		87 (7-4)
14	RBL	7	0F	Right H Blanking	50/60HZ	17 (3-0)	87 (3-0)		
WHB	0	RDR	2A	3F	R Drive	DYNAMIC/others	09 (7-2)	CXA2130S(88H)	8F (7-2)
	1	GDR	2A	3F	G Drive	DYNAMIC/others	0A (7-2)		90 (7-2)
	2	BDR	2A	3F	B Drive	DYNAMIC/others	0B (7-2)		91 (7-2)
	3	RCT	7	0F	R Cutoff	SECAM/others	07 (3-0)		93 (3-0)
	4	GCT	7	0F	G Cutoff	SECAM/others	08 (7-4)		94 (7-4)
	5	BCT	7	0F	B Cutoff	SECAM/others	08 (3-0)		94 (3-0)
	6	BMN	15	1F	Brightness Minimum Data				97
7	SBR	28	3F	Sub Brightness Control			98		
SAJ	0	PMX	33	3F	Picture Maximum Data			CXA2130S(88H)	96
	1	SHU	8	0F	Sub Hue Control	TV/Video			99
	2	SSH	3	0F	Sub Sharpness Control	TV/Video			9A
	3	SCL	1F	3F	Sub Color Control	NTSC/others			9B
VP	0	EHT	4	0F	EHT Comp	50/60HZ	15 (3-0)	CXA2130S(88H)	85 (3-0)
	1	GMA	2	03	Gamma Correction	Refer NVM Map A4	0B (1-0)		1A3 (1-0)
	2	YDL	6	0F	Y Delay	PAL/SECAM/NTSC	0C (3-0)		8C (3-0)
	3	SST	1	03	SECAM ID Start Position		1B (1-0)		6A (1-0)
	4	SSP	1	03	SECAM ID Stop Position		1B (3-2)		6A (3-2)
	5	SLV	2	03	SECAM ID Level		1C (1-0)		6B (1-0)
	6	SBF	22	3F	SECAM BELL f0		1C (7-2)		6B (7-2)
	7	DYC	0	1	Dynamic Color on/off		0A (1)		59 (1)
	8	ABL	1	1	ABL Mode Switching	STANDARD Always 0	09 (1)		58 (1)
	9	VTH	1	1	ABL Detection Vth Switching		09 (0)		58 (0)
	10	SFO	1	1	FO Switching for Sharpness	NTSC/others	05 (1)		198 (1)
	11	DCX	1	1	DC Trans. Ratio Switching		06 (1)		55 (1)
12	SHT	1	1	Pre-/Overshoot ratio Switch	NTSC/others	06 (0)	199 (0)		

Adjustment Item Table

Category	Functionality		Micro Init	Data Range	Function	Note for Different Data	Register No. (bit)	Slave Address	RAM Address (bit)
	No.	Name							
VP	13	HDW	0	1	H Drive Pulse Width Switch	TV/Video/Text	00 (6)	TDA7429	4F (6)
	14	AFC	1	03	AFC Gain Control		0F (1-0)		8D (1-0)
	15	HOS	7	0F	H Oscillation		0C (7-4)		5B (7-4)
	16	HSS	0	1	Slice Level of H Sync Sep.		0D (1)		5C (1)
	17	VSS	0	1	Slice Level of V Sync Sep.	0D (0)	5C (0)		
	18	HMS	0	1	Macro Vision C/m off/on	50/60Hz 0E (0)	7E (0)		
	19	YUV	0	1	YUV Switch Control	01 (0)	50 (0)		
	20	CDV	1	3	CD mode for Video	Video only 0D (5-4)	1A1 (5-4)		
	21	RON	1	1	R ON	not memorized 01 (3)	50 (3)		
	22	GON	1	1	G ON	not memorized 01 (2)	50 (2)		
	23	BON	1	1	B ON	not memorized 01 (1)	50 (1)		
	24	PON	1	1	P ON	not memorized 00 (7)	4F (7)		
	25	BLK	0	1	BLK Off	12 (0)	61 (0)		
	26	VMC	0	1	VM Off	13 (0)	62 (0)		
AP	0	INF	0	3F	Input Attenuation When surround off	00 (5-0)	TDA7429	19F (5-0)	
	1	INS	0	3F	Input Attenuation When surround on	02		1A0 (5-0)	
	2	PH1	0	3	Phase 1 Register Selection			76 (1-0)	
	3	PH2	0	3	Phase 2 Register Selection			76 (3-2)	
	4	PH3	0	3	Phase 3 Register Selection			76 (5-4)	
	5	PH4	0	3	Phase 4 Register Selection	76 (7-6)			
	6	BCS	2	3	Bass Center Shift	#4 (3-0)		1A8 (1-0)	
	7	TCS	2	3	Treble Center Shift	#5 (3-0)		1A9 (1-0)	
8	TRF	2	3	RF Treble Offset	#5 (3-0)	1A9 (5-4)			
MSP	0	WST	15	FF	W/G Stereo Threshold	MSP3415D (84H)	MSP3415D (84H)	157 (7-0)	
	1	WBT	EA	FF	W/G Bilingual Threshold			158 (7-0)	
	2	WLL	5	FF	W/G Monaural Threshold			159 (7-0)	
	3	WAC	0	0F	W/G Agreement Count			15A (3-0)	
	4	WDL	30	FF	W/G Search Delay			15B (7-0)	
	5	NDL	20	FF	NICAM Search Delay			15C (7-0)	
	6	SDL	10	FF	Stereo status Read Delay			15D (7-0)	
	7	AGC	1	1	AGC Switch Auto/Constant			BB (7)	108 (7)
	8	REL	28	3F	AGC Gain at Constant Mode			BB (6-1)	108 (6-1)
	9	CRM	0	1	Carrier muting on/off			BB (9)	107 (1)
	10	ACO	1	1	Audio Clock out on/off			83 (5)	10C (5)
	11	FP	1B	7F	FM Prescale for non-M system			0E (7-0)	16C (6-0)
	12	FPM	32	7F	FM Prescale for M system			0E (7-0)	16D (6-0)
	13	FH	36	7F	FM Prescale for HDEV			0E (7-0)	16E (6-0)
	14	FHM	65	7F	FM Prescale for HDEV and M			0E (7-0)	16F (6-0)
	15	WGP	2A	7F	W/G Prescale			0E (7-0)	170 (6-0)
	16	NIP	6D	7F	NICAM Prescale			10 (7-0)	138 (6-0)
	17	ERR	50	FF	Auto FM switch Threshold			21 (10-3)	166 (7-0)
18	VOL	6D	FF	Loud Speaker gain 7000h to 7f0h	0000 (15-4)	1A7 (7-0)			

Adjustment Item Table

Category	Functionality		Micro Init	Data Range	Function	Note for Different Data	Register No. (bit)	Slava Address	RAM Address (bit)
	No.	Name							
TXT	0	TXH	1	3	Teletext Horizontal Position			(58H)	18D (1-0)
	1	TXV	0	3	Teletext Vertical Position				18D (6-4)
OPM	0	OSH	0A	3F	OSD H Position	Option-Misc			AC (7-2)
	1	COM	0	03	Comb Selection				A5 (7-6)
	2	APC	1	1	APC Switch				A4 (5)
	3	TSY	0	03	TV Sys at Auto TV Sys				A4 (4-3)
	4	MUT	0	1	No Signal Mute				A4 (0)
	5	AFM	0	1	Auto FM switch				A4 (1)
	6	RFB	0	3	C-BPF Control				A5 (5-4)
	7	TV0	0	7	Tilt to V-Angle offset				A5 (2-0)
8	DBL	0	1	Disable Blueback Function	A4 (2)				
OPB	0	OP1	FF	FF	Optional Bits 1 (see below)	Option-Bits			45
	1	OP2	1	FF	Optional Bits 2 (see below)				46
	2	OP3	0	FF	Optional Bits 3 (see below)				47

NOTE

- shaded items are fixed data.
- Standard data listed on the Adjustment Item Table are reference values, therefore it may be different for each model and for each mode.
- Note for Different Data Those are the standard data values written on the microprocessor. Therefore, the data values of the modes and stored respectively in the memory.
In case of a device replacement, adjustment by rewriting the data value is necessary for some items.

**KV-PF21L70/PF21M40/PF21M70/PF21P10
KV-PF21P40/PF21P41/PF21Q70**

RM-952

ITEM INFORMATION.

No. OPB0 OP1

Item	XTAL 4.43	XTAL 3.58	SECAM	2nd. Lang	B/G	I	D/K	M
KV-PF21L70	1	1	1	1	1	0	0	0
KV-PF21M40	1	1	1	1	1	1	1	1
KV-PF21M70 (E)	1	1	1	1	1	1	1	1
KV-PF21M70 (ME)	1	1	1	1	1	1	1	1
KV-PF21P10	1	1	0	1	1	0	0	0
KV-PF21P40 (Singapore)	1	1	0	1	1	0	0	0
KV-PF21P40 (Malaysia)	1	1	0	1	1	0	0	0
KV-PF21P41	1	1	0	1	1	0	0	0
KV-PF21Q70	1	0	1	1	1	0	0	0

No. OPB1 OP2

Item	TOP	NICAM	HDEV	Thai Bil	Dis Fav.	DVD Input	AV Input	
KV-PF21L70	0	0	0	0	1	0	1	0
KV-PF21M40	0	0	0	0	1	0	1	0
KV-PF21M70 (E)	0	0	0	0	1	0	1	0
KV-PF21M70 (ME)	0	0	0	0	1	0	1	0
KV-PF21P10	0	0	0	0	1	0	1	0
KV-PF21P40 (Singapore)	0	0	0	0	1	0	1	0
KV-PF21P40 (Malaysia)	0	0	0	0	1	0	1	0
KV-PF21P41	0	0	0	0	1	0	1	0
KV-PF21Q70	0	0	0	0	1	0	1	0

No. OPB2 OP3

Item	Pic Rot	2199 Curve	Auto PIC	Auto TV sys	US ST	AV Mono	11 KEY	Color SW
KV-PF21L70	0	0	1	0	0	1	0	1
KV-PF21M40	0	0	1	0	0	1	0	1
KV-PF21M70 (E)	0	0	1	0	0	1	0	1
KV-PF21M70 (ME)	0	0	1	0	0	1	0	1
KV-PF21P10	0	0	1	0	0	1	0	1
KV-PF21P40 (Singapore)	0	0	1	0	0	1	0	1
KV-PF21P40 (Malaysia)	0	0	1	0	0	1	0	1
KV-PF21P41	0	0	1	0	0	1	0	1
KV-PF21Q70	0	0	1	0	0	1	0	1

4-3. PICTURE QUALITY ADJUSTMENTS

SUB COLOR ADJUSTMENT

1. Input a PAL color-bar.
2. Set to the following condition:
PICTURE 100%, BRIGHTNESS 50%, COLOR 50%
3. Connect an oscilloscope to pin ① (B OUT) of CN305, A board.
4. Set to Service Mode and select SAJ 3 'SCL' with **[1]** and **[4]** of the commander then adjust to VB2=VB3=VB4 with **[3]** and **[6]**.
5. Press **[MUTING]** → **[0]** of the commander to write the data.
6. Adjust SAJ 3 'SCL' as step 2 to 5 when receiving NTSC color-bar.

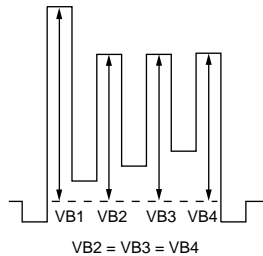

SUB HUE ADJUSTMENT

1. Select Video 1.
2. Input a NTSC color-bar, video into Video 1.
3. Set the following condition:
PICTURE 100%, BRIGHTNESS 50%, COLOR 50%
4. Connect an oscilloscope to pin ① (B OUT) of CN305, A board.
5. Select SAJ 1 'SHU' with **[1]** and **[4]** of the commander by setting to Service Mode and adjust to VB1=VB2=VB3=VB4 with **[3]** and **[6]**.

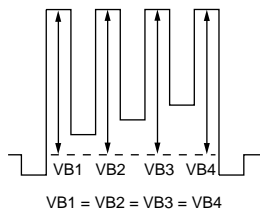

6. Press **[MUTING]** → **[0]** of the commander to write the data.

BELL FILTER ADJUSTMENT

1. Input SECAM color-bar signal.
2. Connect the dual-trace oscilloscope to the pin ⑨ (R-Y) of CN303 (not mounted).
3. Adjust SERVICE MODE, ITEMS 'SBF' as shown below.

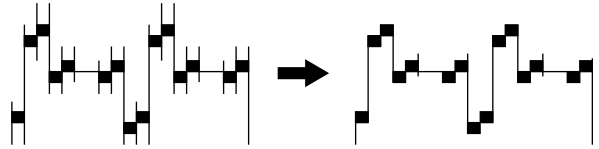

4-4. A BOARD ADJUSTMENT AFTER IC003 (MEMORY) REPLACEMENT

When replacing IC003 (MEMORY), be sure to change IC001 (μ-COM) to the following new IC at the same time.

IC001 (μ-CON) : CXP86461-622S (For ME)
: CXP86461-623S (Except ME)

1. Enter to Service Mode.
2. Press commander buttons **[5]** and **[0]** (Data Initialize), and **[2]** and **[0]** (Data Copy) to initialize the data.
3. Call each item number and check if the respective screen shows the normal picture.
In cases where items are not well adjusted, rectify the items with fine adjustment.
Write the data per each item number (**[MUTING]** + **[0]**).
4. Select item numbers "OPB0" (OP1), "OPB1" (OP2) and "OPB2" (OP3) and respectively set the bit per model with command buttons **[3]** and **[6]**.
5. Press commander buttons **[8]** and **[0]** (Test Normal) to return to the data that was set on the shipment from the factory.
(This will also cancel Service Mode.)

4-5. PICTURE DISTORTION ADJUSTMENT

Item Number 00 – 0B

GEO 0 HSH (H POSITION)



GEO 1 HSZ (H SIZE)

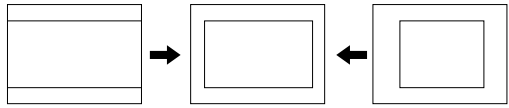

GEO 2 PAP (PIN AMP)

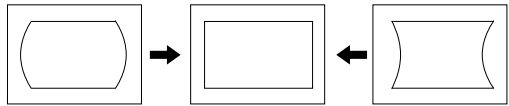

GEO 3 TILT (TRAPEZIUM)

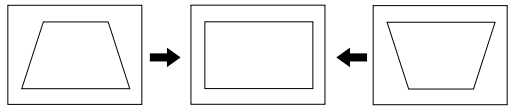

GEO 4 VSH (V POSITION)

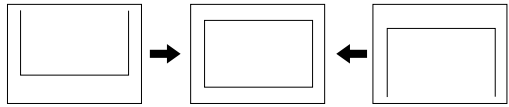

GEO 5 VSZ (V SIZE)

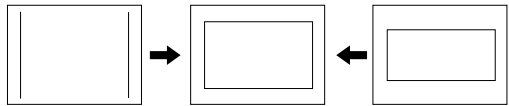

GEO 6 SCR (VERTICAL S-Correction)

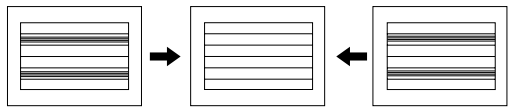

GEO 7 VLN (V LINEARITY)

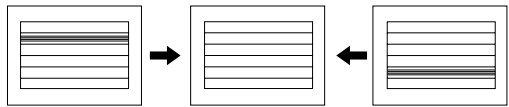

GEO 8 VBOW (AFC.BOW)

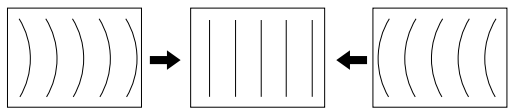

GEO 9 AGL (AFC.ANGLE)

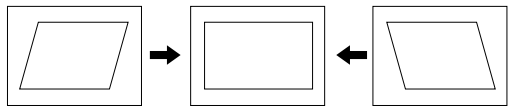

GEO 0A UCP (UPPER CORNER PIN)

GEO 0B LCP (LOWER CORNER PIN)

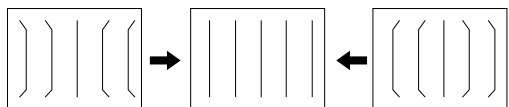

**SECTION 5
DIAGRAM**

KV-PF21L70/PF21M40/PF21M70/PF21P10
KV-PF21P40/PF21P41/PF21Q70

RM-952

KV-PF21L70/PF21M40/PF21M70/PF21P10
KV-PF21P40/PF21P41/PF21Q70

RM-952

KV-PF21L70/PF21M40/PF21M70/PF21P10
KV-PF21P40/PF21P41/PF21Q70

RM-952

5-1. BLOCK DIAGRAM

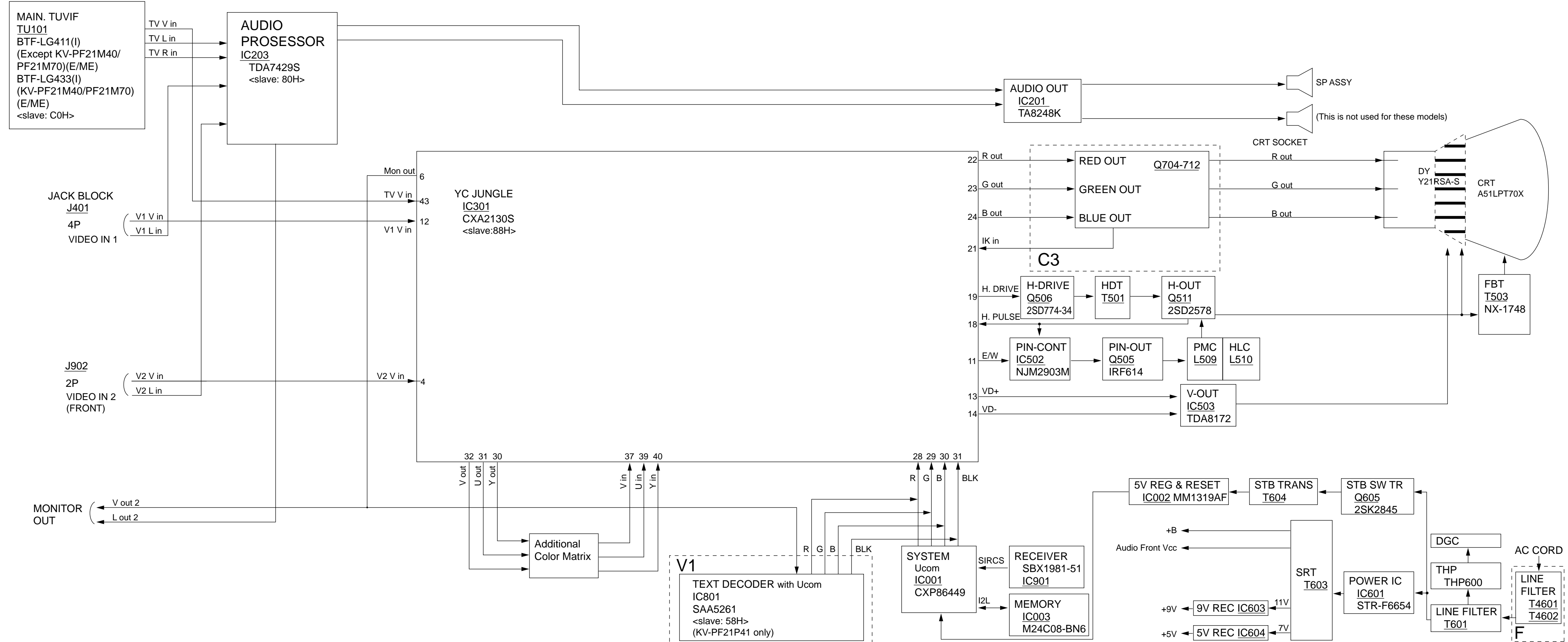

5-2. FRAME SCHEMATIC DIAGRAM

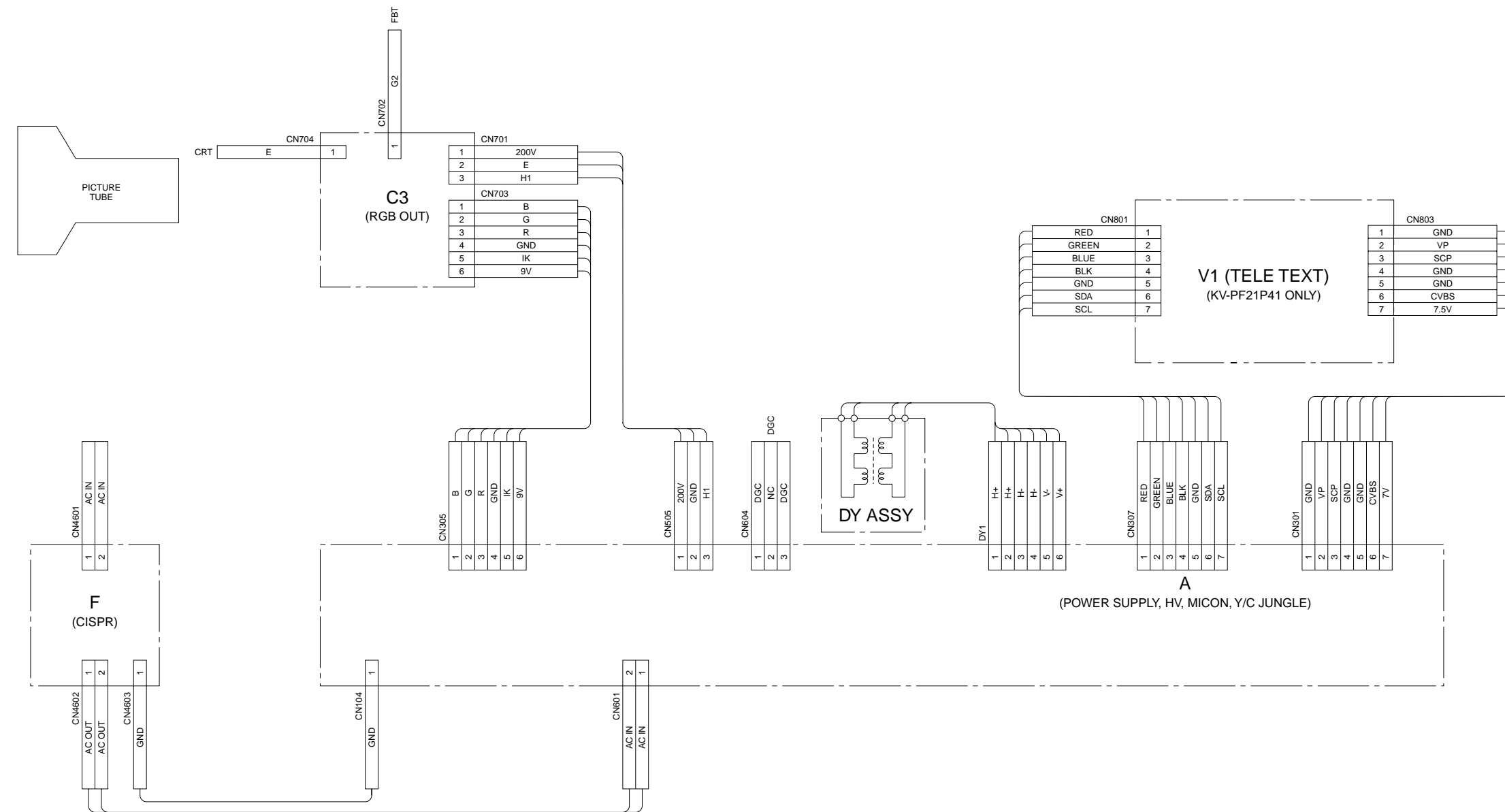

5-3. CIRCUIT BOARDS LOCATION

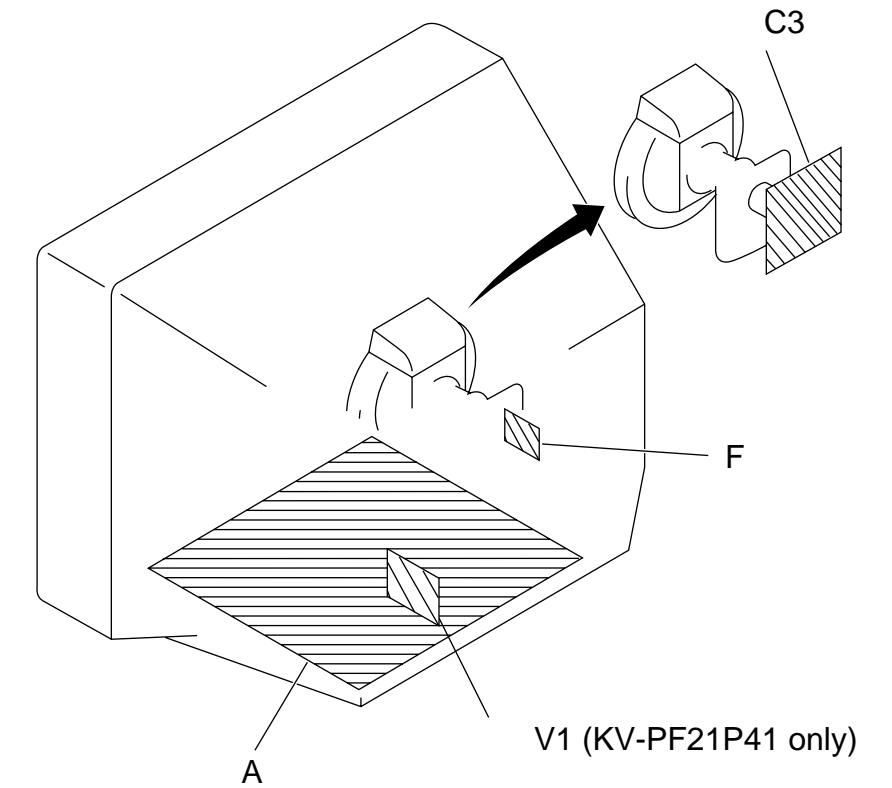







5-4. SCHEMATIC DIAGRAMS AND PRINTED WIRING BOARDS

Note:

- All capacitors are in μF unless otherwise noted.
- All electrolytic capacitors are rated at 50V unless otherwise noted.
- All resistors are in ohms.
 $\text{k}\Omega = 1000\Omega$, $\text{M}\Omega = 1000\text{k}\Omega$
- Indication of resistance which does not have rating electrical power is as follows.

Pitch: 5 mm
Rating electrical power 1/4W (CHIP: 1/10W)

-  : nonflammable resistor.
-  : internal component.
-  : panel designation or adjustment for repair.
- All variable and adjustable resistors have characteristic curve B unless otherwise noted.
- **Readings are taken with a color-bar signal input.**
no mark : PAL
() : SECAM
[] : NTSC 3.58
« » : NTSC 4.43
- **Readings are taken with a 10 M Ω digital multimeter.**
- **Voltage are dc with respect to ground unless otherwise noted.**
- **Voltage variations may be noted due to normal production tolerances.**
- **All voltages are in V.**
- * : **Cannot be measured.**
- **Circled numbers are waveform references.**
-  : **B + bus.**
-  : **B - bus.**
-  : **signal path.**

Reference information

RESISTOR	: RN	METAL FILM
	: RC	SOLID
	: FPRD	NONFLAMMABLE CARBON
	: FUSE	NONFLAMMABLE FUSIBLE
	: RS	NONFLAMMABLE METAL OXIDE
	: RB	NONFLAMMABLE CEMENT
	: RW	NONFLAMMABLE WIREWOUND
	: ✕	ADJUSTMENT RESISTOR
COIL	: LF-8L	MICRO INDUCTOR
CAPACITOR	: TA	TANTALUM
	: PS	STYROL
	: PP	POLYPROPYLENE
	: PT	MYLAR
	: MPS	METALIZED POLYESTER
	: MPP	METALIZED POLYPROPYLENE
	: ALB	BIPOLAR
	: ALT	HIGH TEMPERATURE
	: ALR	HIGH RIPPLE

Note: The component identified by shading and mark \triangle are critical for safety. Replace only with part number specified.

A BOARD IC001 CXP86461-622S (FOR ME)

A BOARD IC001 CXP86461-623S (EXCEPT ME)

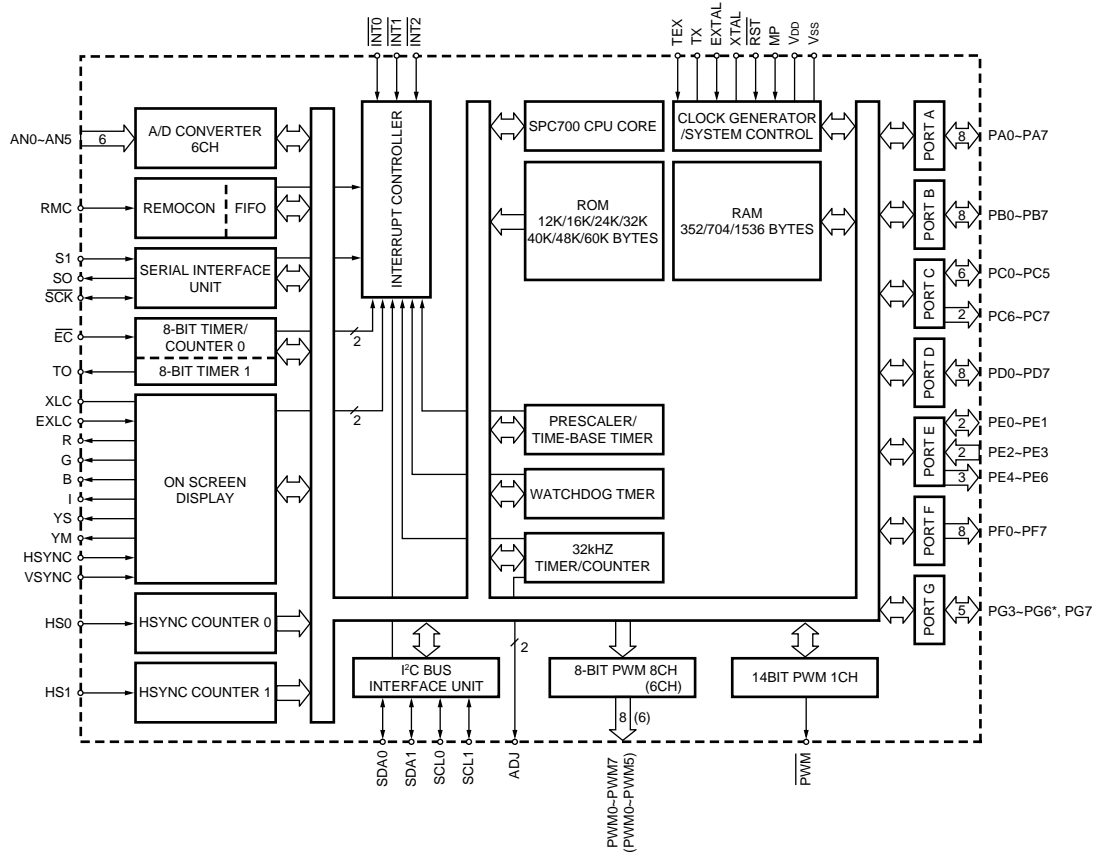

A BOARD WAVEFORMS

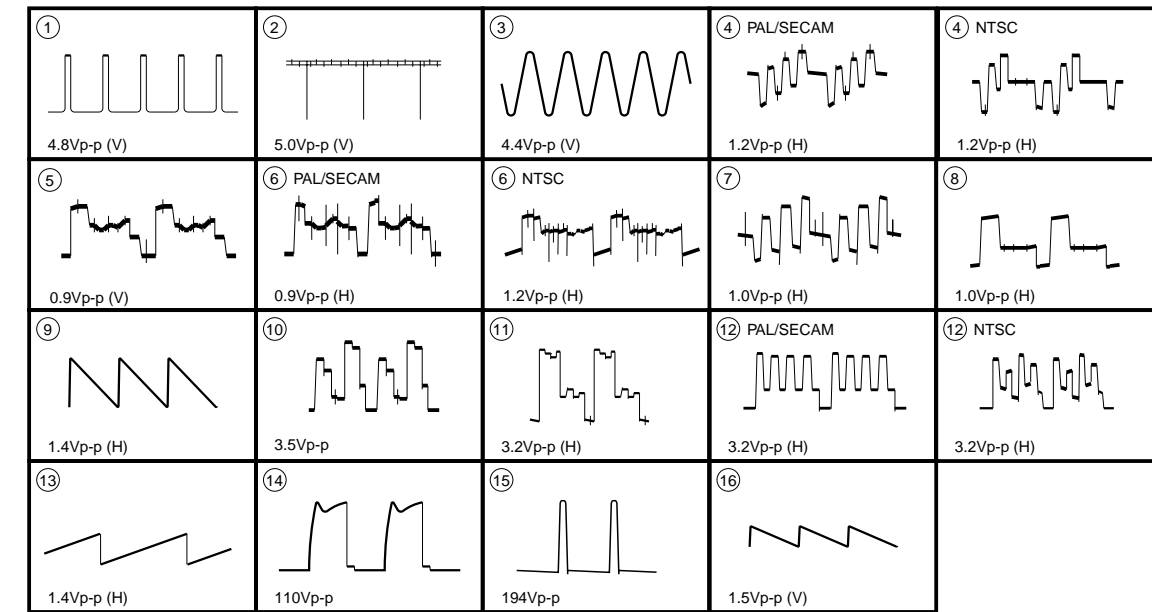

A BOARD

IC		D004	D-8	D614	H-7
IC001	B-10	D005	B-8	D615	E-7
IC002	C-9	D006	A-3	D616	E-9
IC003	A-9	D203	C-11	D617	F-8
IC100	B-5	D300	A-9	D618	F-9
IC201	B-11	D301	B-9	D620	D-8
IC203	C-3	D302	B-6	D621	F-8
IC204	B-2	D303	B-5	D622	F-7
IC301	B-6	D304	B-5	D623	F-12
IC502	E-6	D305	B-5	D624	F-12
IC503	J-5	D306	C-5	D625	D-12
IC601	H-6	D307	C-5	D627	F-8
IC602	H-6	D308	B-5	D628	G-5
IC603	D-8	D309	B-6	D629	F-9
IC604	D-10	D310	A-6	D630	E-9
IC901	I-13	D311	C-6	D631	G-12
PH600	H-7	D312	C-6	D632	F-12
		D313	A-8	D633	E-12
		D315	B-7	D634	F-11
		D316	C-7	D635	F-12
		D317	B-9	D636	D-12
		D314	A-9	D637	F-11
		D319	C-6	D638	E-11
		D320	C-6	D901	C-13
		D321	B-6	D902	D-13
		D401	D-2	D903	C-13
		D402	C-3	D904	D-13
		D403	B-1	D905	F-13
		D404	C-2	D906	I-13
		D405	C-1		
		D406	B-1		
		D407	C-2		
		D408	C-1		
		D409	A-1		
		D504	D-5		
		D505	H-6		
		D506	F-6		
		D507	F-6		
		D508	I-5		
		D509	E-6		
		D510	F-5		
		D511	F-5		
		D512	G-5		
		D513	I-5		
		D517	F-2		
		D518	F-2		
		D519	F-2		
		D520	E-5		
		D521	I-4		
		D522	J-4		
		D525	F-5		
		D526	F-6		
		D527	F-3		
		D528	F-3		
		D529	F-5		
		D530	F-2		
		D531	E-6		
		D532	E-6		
		D533	D-2		
		D534	E-6		
		D600	G-13		
		D601	I-8		
		D602	G-13		
		D603	F-11		
		D604	J-7		
		D605	G-10		
		D606	E-11		
		D607	F-10		
		D608	E-11		
		D609	H-8		
		D610	J-8		
		D611	I-7		
		D612	F-8		
		D613	I-7		
TRANSISTOR					
Q001	B-8				
Q002	B-8				
Q003	C-9				
Q004	C-9				
Q101	A-4				
Q201	A-11				
Q202	A-11				
Q203	C-11				
Q204	C-11				
Q205	A-12				
Q206	A-11				
Q207	A-11				
Q301	B-8				
Q302	A-6				
Q303	A-6				
Q304	B-6				
Q305	B-5				
Q306	B-5				
Q307	C-7				
Q308	C-7				
Q309	C-7				
Q310	D-7				
Q311	D-9				
Q312	B-7				
Q313	B-8				
Q315	B-5				
Q401	D-2				
Q402	D-1				
Q403	D-2				
Q404	C-3				
Q501	D-6				
Q502	E-7				
Q503	F-6				
Q505	D-6				
Q506	D-2				
Q507	H-6				
Q509	F-6				
Q511	F-1				
Q600	C-12				
Q601	F-11				
Q602	J-7				
Q603	I-7				
Q604	H-6				
Q605	E-12				
Q606	F-11				
Q607	H-13				
Q901	H-13				
Q902	H-13				
DIODE					
D001	B-8				
D002	C-8				
D003	C-9				

PRINTED WIRING BOARD

A [POWER SUPPLY, HV, MICON, Y/C JUNGLE]

- A Board -

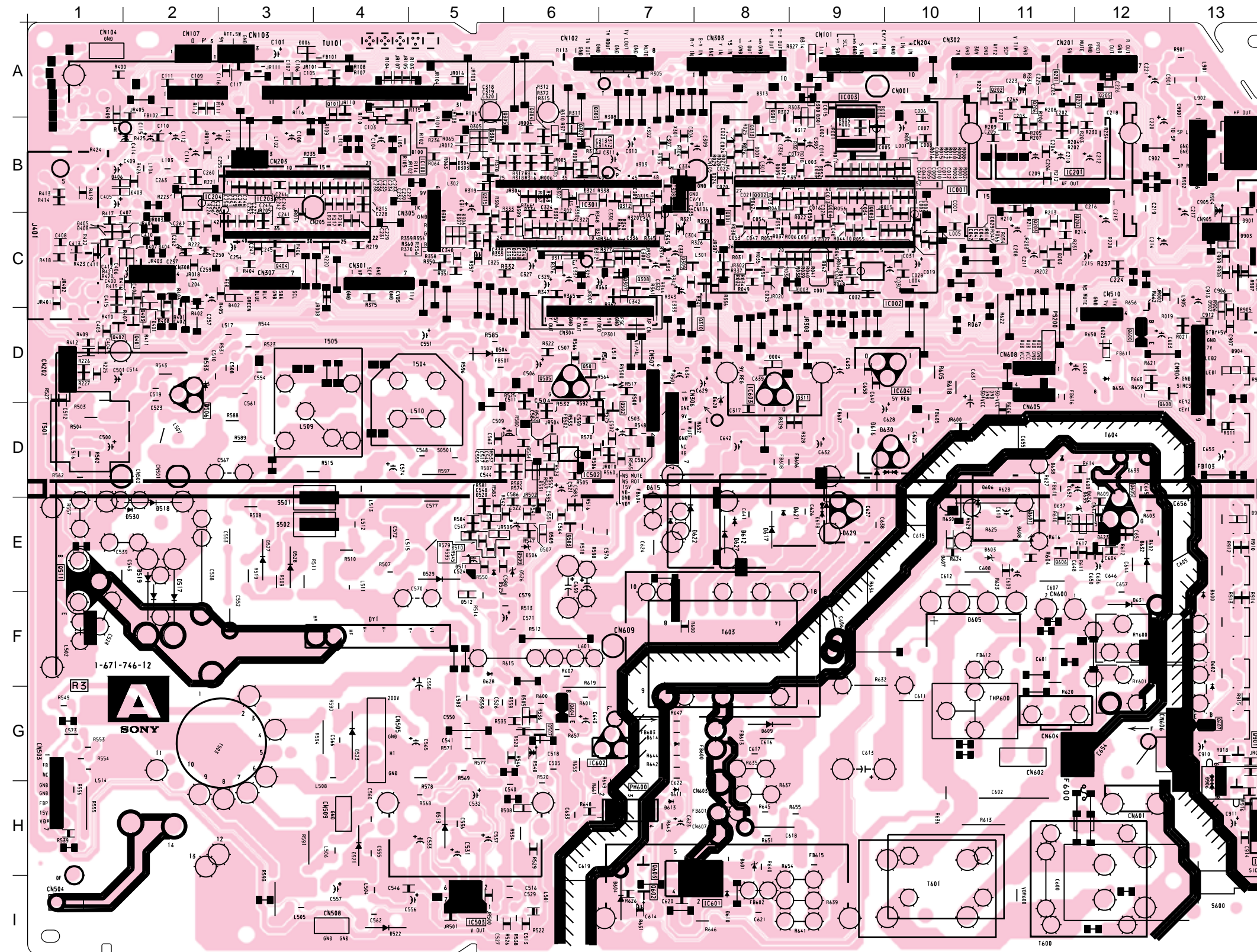

A BOARD * MARK LIST

	KV-PF21L70 (ME)	KV-PF21M40 (GE)	KV-PF21M70 (E)	KV-PF21M70 (ME)	KV-PF21P10 (OCE)	KV-PF21M40 (Singapore)	PF21P40 (Malaysia)	KV-PF21P41 (Malaysia)	KV-PF21Q70 (ME)
C307	18p :CHIP	18p :CHIP	18p :CHIP	18p :CHIP	18p :CHIP	18p :CHIP	18p :CHIP	18p :CHIP	#
C622	0.0015	#	#	0.0015	0.0015	0.0015	0.0015	#	0.0015
C624	1500P 2KV	#	#	1500P 2KV	1500P 2KV	1500P 2KV	1500P 2KV	#	1500P 2KV
CN 301	#	#	#	#	#	#	#	7P	#
CN 307	#	#	#	#	#	#	#	7P	#
IC 001	CXP86449-622S	CXP86449-623S	CXP86449-623S	CXP86449-622S	CXP86449-623S	CXP86449-623S	CXP86449-623S	CXP86449-623S	CXP86449-622S
R 375	#	#	#	#	#	#	#	CHIP 100	#
TU 101	BTF-LG411	BTF-LG433	BTF-LG433	BTF-LG433	BTF-LG411	BTF-LG411	BTF-LG411	BTF-LG411	BTF-LG411
X 302	CTYSTAL	CTYSTAL	CTYSTAL	CTYSTAL	CTYSTAL	CTYSTAL	CTYSTAL	CTYSTAL	#

Note) The parts indicated as "#" in this circuit diagram are not listed here, as they are not used in this models.

NOTE:
The circuit indicated at left contains high voltage of over 600 Vp-p. Please pay attention when inspecting or repairing it to prevent an electric shock.

(3) Schematic Diagrams of C3 and F boards

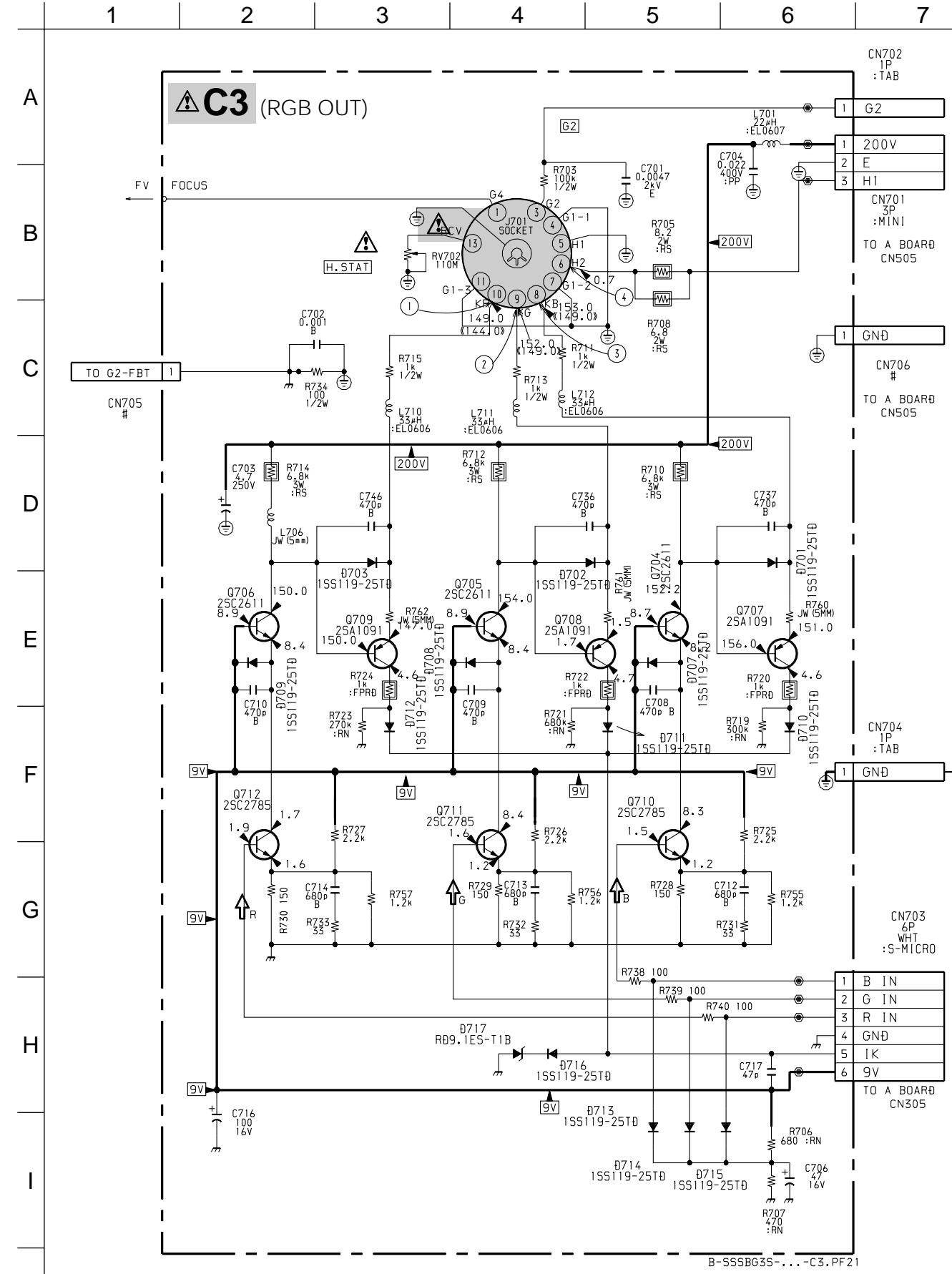

C3 BOARD WAVEFORMS

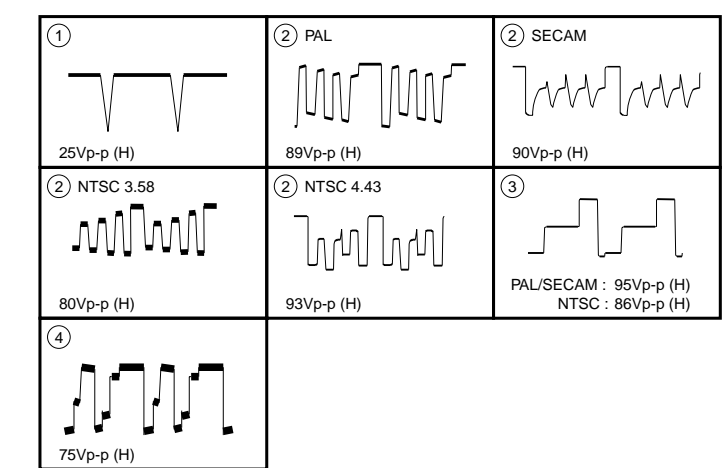

F [CISPR] C3 [RGB OUT]

PRINTED WIRING BOARD

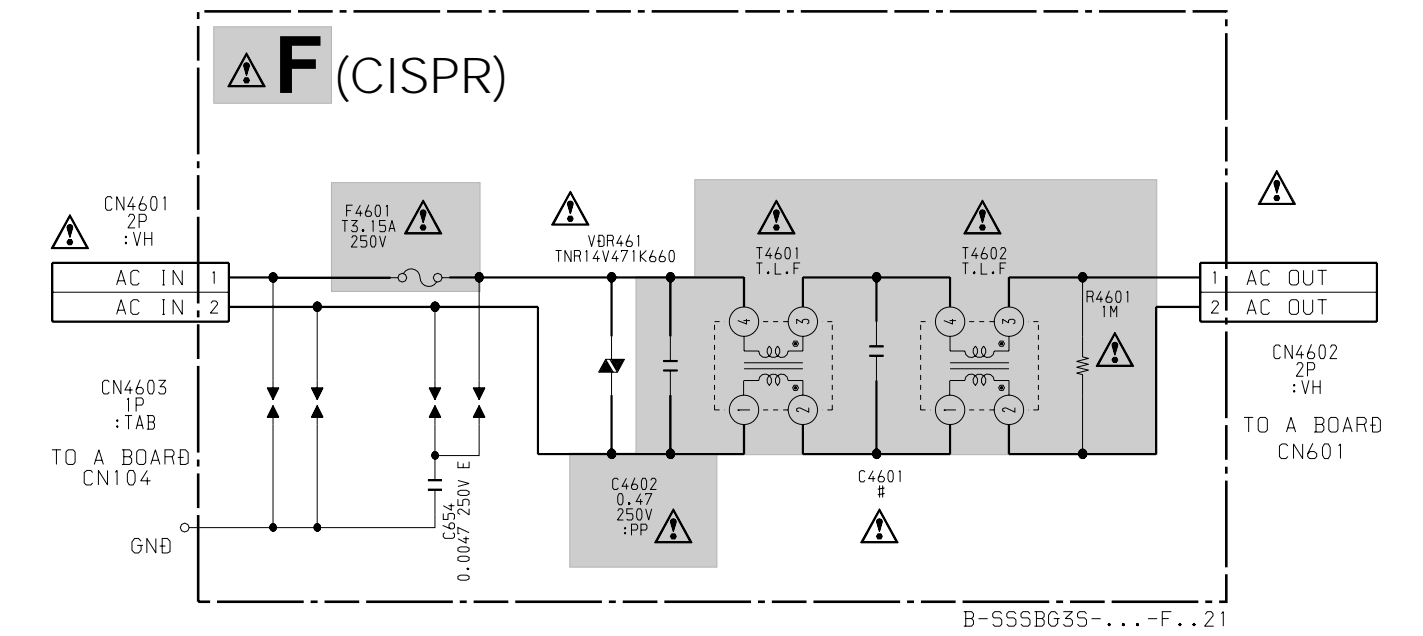

- F Board -

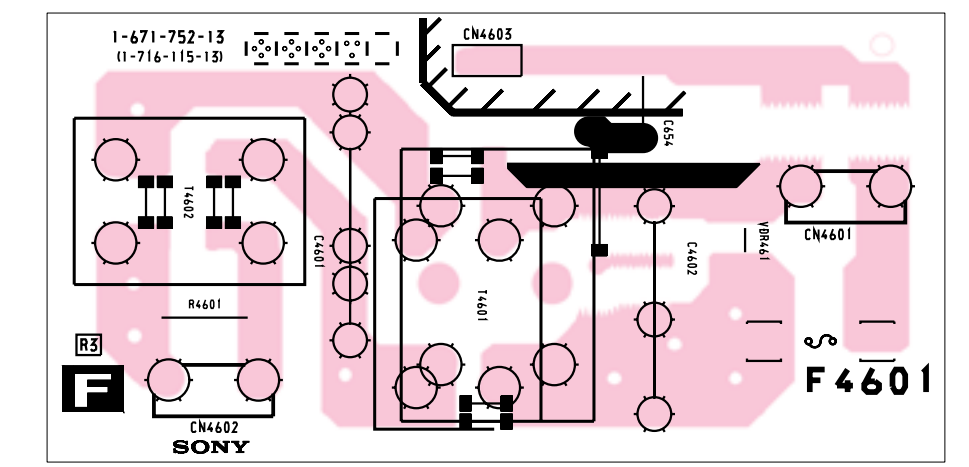

- C3 Board -

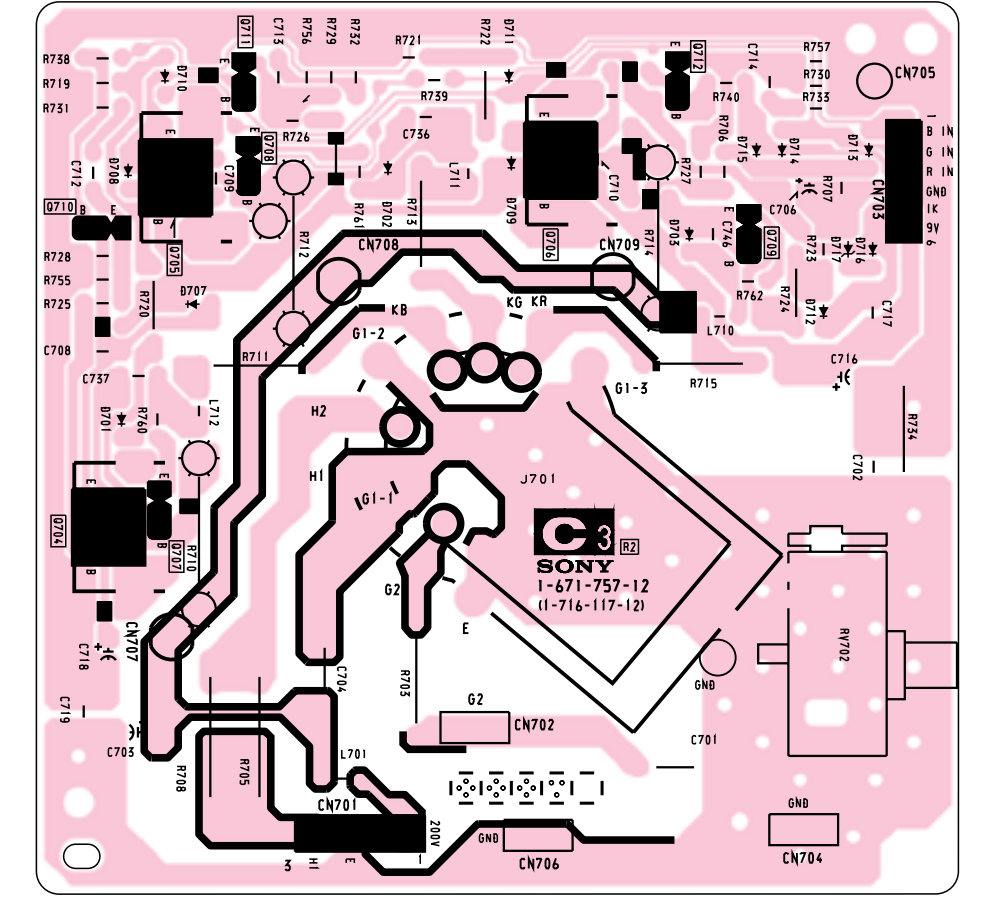

(4) Schematic Diagrams of V1 board

1 2 3 4 5 6 7 8 9 10 11 12 13 14 15

A

B

C

D

E

F

G

H

I

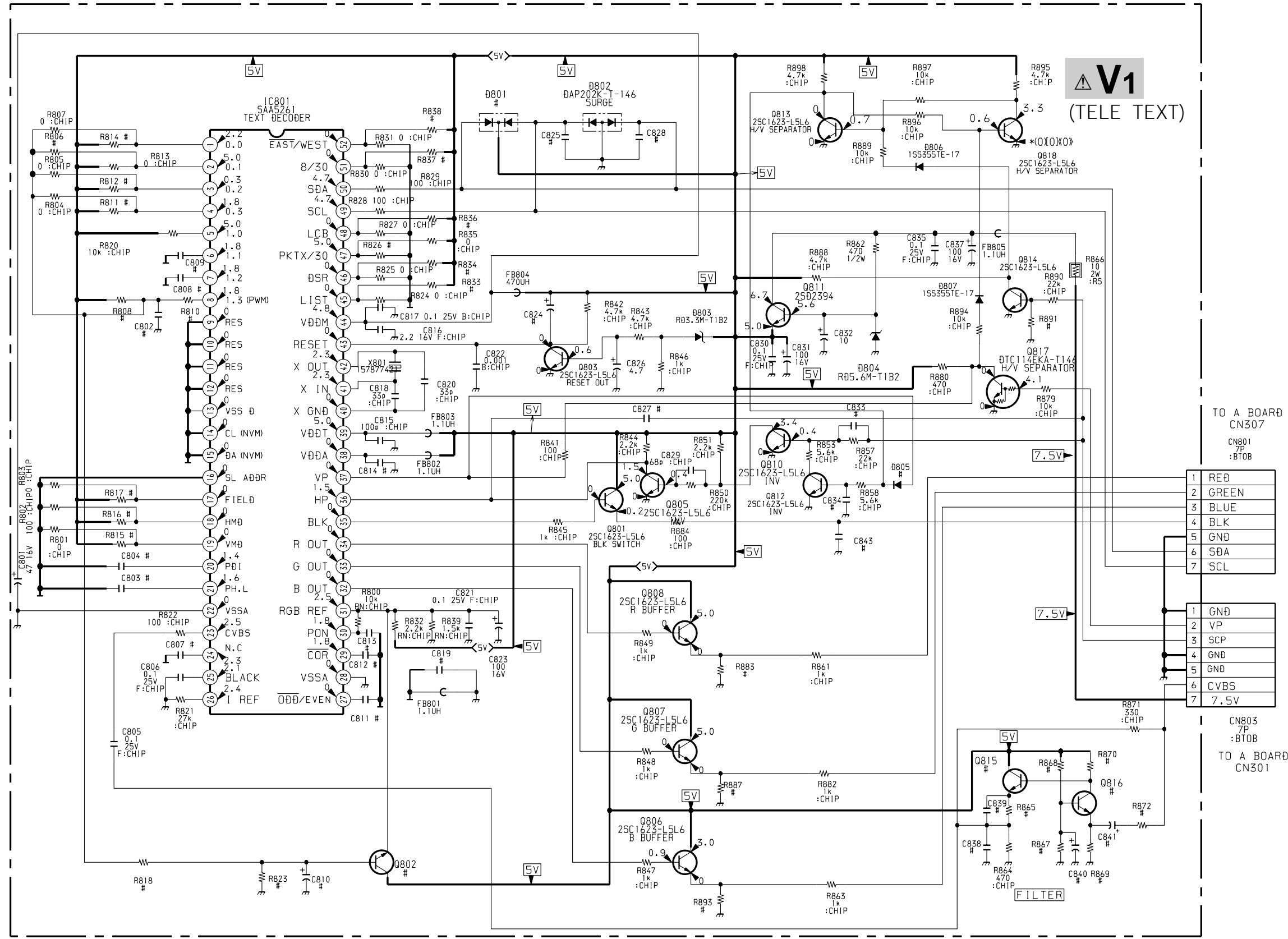

V1
(TELE TEXT)

TO A BOARD
CN307

- 1 RED
- 2 GREEN
- 3 BLUE
- 4 BLK
- 5 GND
- 6 SDA
- 7 SCL

- 1 GND
- 2 VP
- 3 SCP
- 4 GND
- 5 GND
- 6 CVBS
- 7 7.5V

TO A BOARD
CN301

B-SSSBG3S-...-V1.21

PRINTED WIRING BOARD

V1 (TELE TEXT)

- V1 Board - (KV-PF21P41 only)

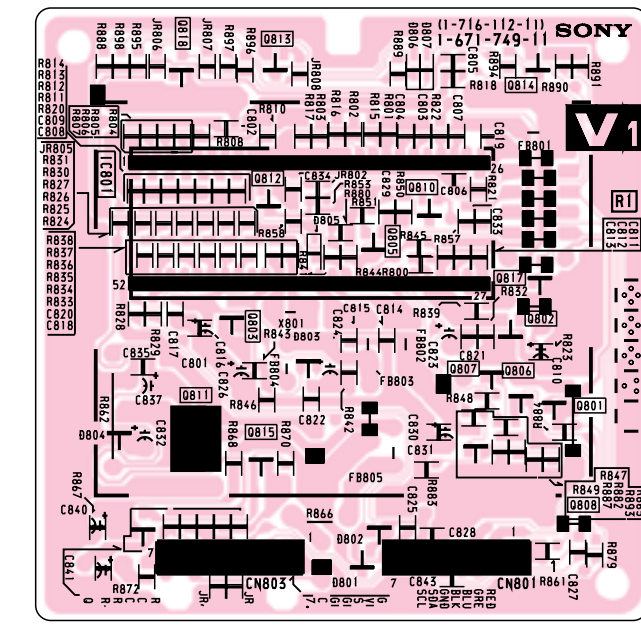

5-5. SEMICONDUCTORS

DIODE

AU-01Z-V1
EL1Z
GP08D
RD33EB3T
RGP02-17EL-6433

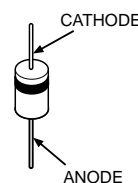

D4SB60L

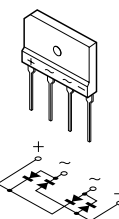

ERC04-06SE
RN4Z
RS 3FS
31DQ06-FC5

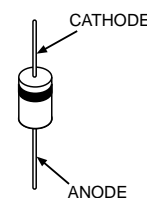

ERD29-08J

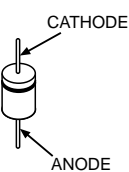

ON3171-R

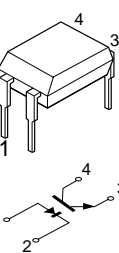

D1NS4
RD1.1ES-L2
RD20ES-B2
RD30ESB2
RD6.8ES-B1
1SS119-25
11EQS04
11ES2-NTA2B

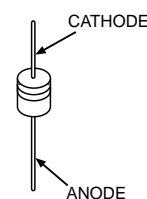

DTZ-TT11-15B
DTZ-10B
MA 111-(K8).SO
UDZS-TE17-5.1B
UDZS-TE17-6.8B
1SS355TE-17

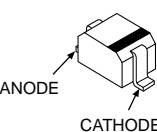

5P6M

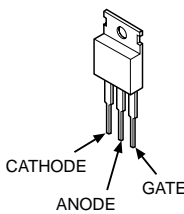

DA204K

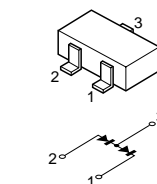

FMU-G26S

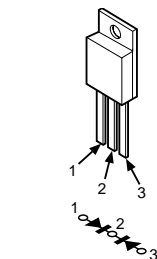

TRANSISTOR

DTC114EK
UN2111
UN2211
UN2213
UN2216
2SC1623-L5L6
2SC2712-YG

RD3.3M-B2
RD5.6M-B2

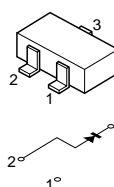

EG01CV0

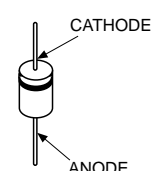

DAP020K

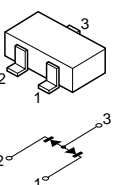

LED

SPB-26MVWF

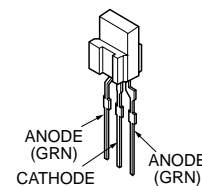

2SA1091-O

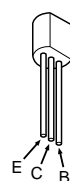

2SD2394-EF

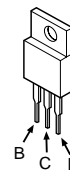

2SD2144S-UVW



2SC2611

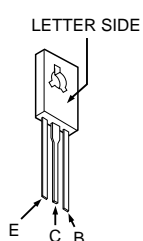

2SC2785-HFE

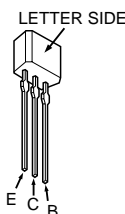

IC

CXA2130S (64PIN)
CXP86449-622S (64PIN)
CXP86449-623S (64PIN)
TDA7429S (42PIN)

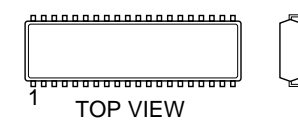

Dual In-line Package
Pin 6~98

MM1319AFBE (7PIN)
NJM2903M (8PIN)

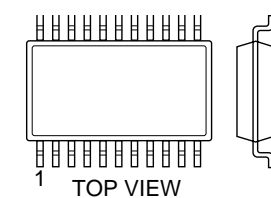

Single In -line Package
Pin 6~98

NJM78M09FA
TA7805S

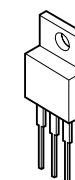

SBX1981-51



SE-135N

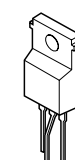

TDA8172

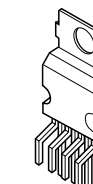

STR-F6654

MARKING SIDE VIEW

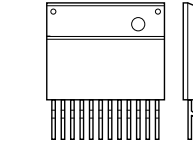

Zig-zag In -line Package
Pin 6~99

RU-1P

MARKING SIDE VIEW

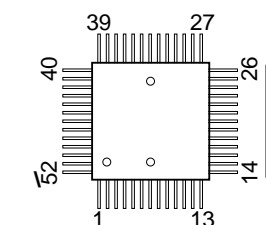

TA8248K

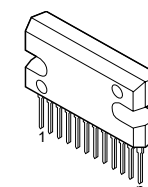

SECTION 6
EXPLODED VIEW

NOTE:

- Items with no part number and no description are not stocked because they are seldom required for routine service.
- The construction parts of an assembled part are indicated with a collation number in the remark column.
- Items marked " * " are not stocked since they are seldom required for routine service. Some delay should be anticipated when ordering these items.

The components identified by shading and mark Δ are critical for safety.
Replace only with part number specified.

6-1. CHASSIS

●: BVTP 3 x 12 7-685-648-79

■: BVTP 4 x 16 7-685-663-71

NOTE : The picture tube for OCE model is upside down, and the position for the anode cap and tension springs are changed accordingly.

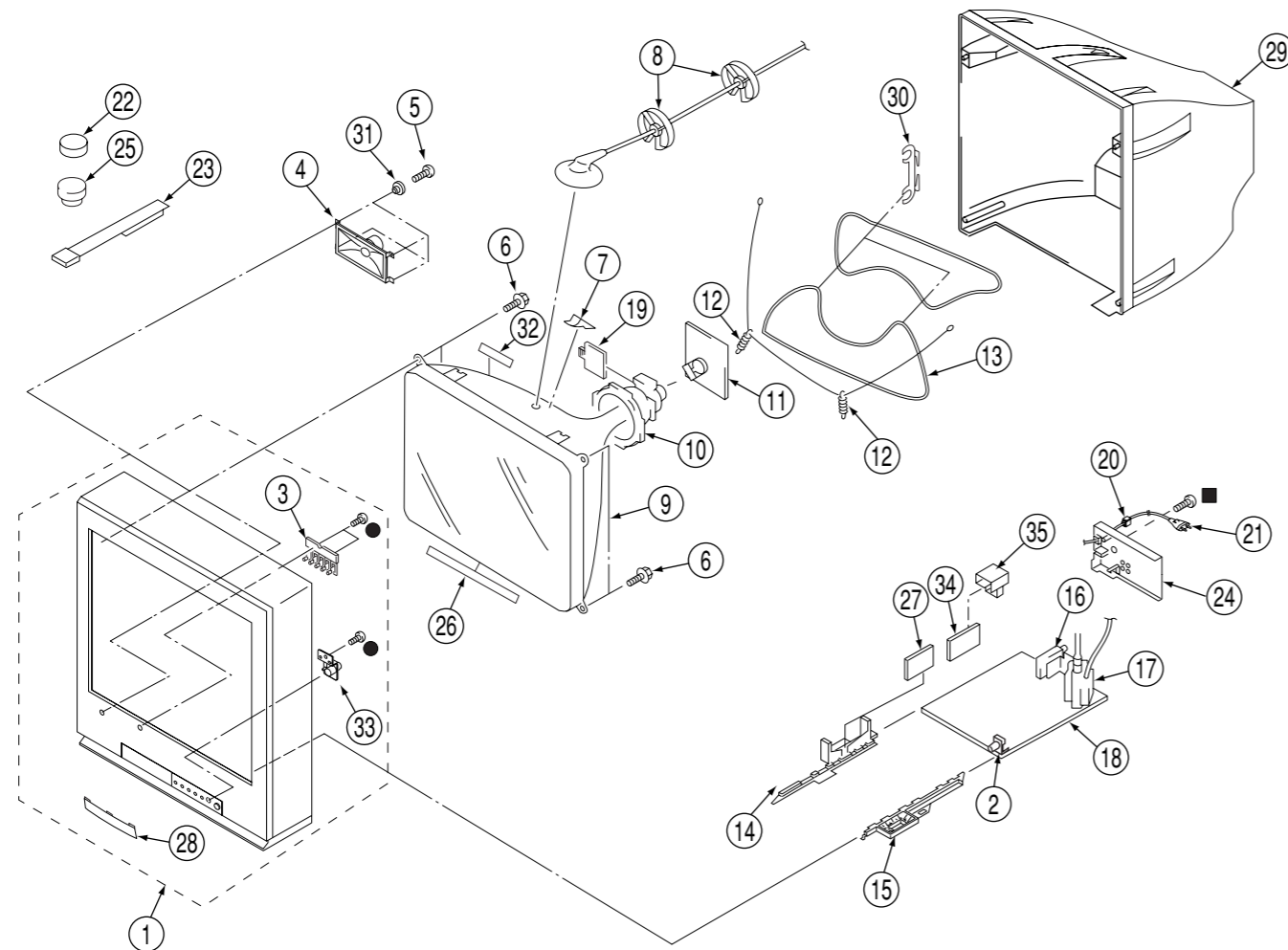

REF. NO.	PART NO.	DESCRIPTION	REMARK	REF. NO.	PART NO.	DESCRIPTION	REMARK
1	X-4036-748-2	BEZNET ASSY (KV-PF21P41)	3,28,33	18	* A-1299-010-A	A BOARD, COMPLETE (KV-PF21P41)	
	X-4036-758-1	BEZNET ASSY (KV-PF21L70)	3,28,33		A-1298-989-A	A BOARD, COMPLETE (KV-PF21P10/P40(MALAYSIA))	
	X-4036-758-3	BEZNET.ASSY (KV-PF21Q70)	3,28,33		A-1298-979-A	A BOARD, COMPLETE (KV-PF21L70)	
	X-4036-748-1	BEZNET.ASSY (KV-PF21M40/PF21M70)	3,28,33		A-1298-978-A	A BOARD, COMPLETE (KV-PF21Q70)	
	X-4036-748-3	BEZNET.ASSY (KV-PF21P10/PF21P40)	3,28,33		A-1298-996-A	A BOARD, COMPLETE (KV-PF21M70(ME))	
2	4-070-291-01	BUTTON, POWER (KV-PF21M40)			A-1298-975-A	A BOARD, COMPLETE (KV-PF21P40(SINGAPORE))	
	4-070-291-11	BUTTON, POWER (KV-PF21L70/PF21Q70/PF21M70/PF21P10/PF21P40)			A-1299-009-A	A BOARD, COMPLETE (KV-PF21M40)	
3	4-070-290-01	BUTTON, MULTI (Except KV-PF21Q70)		19	A-1299-007-A	A BOARD, COMPLETE (KV-PF21M70(E))	
	4-070-290-11	BUTTON, MULTI (KV-PF21Q70)		20	4-057-714-01	PIECE ASSY, TLH CORRECTION	
4	1-505-740-11	SPEAKER (5X9CM)			4-022-115-00	HOLDER, AC CORD	
5	4-054-981-01	SCREW, STEP TAPPING		21	Δ 1-574-062-11	CORD, POWER (WITH CONNECTOR) 2.5A/250V (Except KV-PF21P10)	
6	4-365-808-01	SCREW (5), TAPPING			Δ 1-574-358-11	CORD, POWER (WITH CONNECTOR) 7.5A/250V (KV-PF21P10)	
7	4-046-600-11	SPACER, DY		22	1-452-032-00	MAGNET,DISC	
8	* 3-704-372-11	HOLDER, HV CABLE (Except KV-PF21P10)		23	4-051-736-21	PIECE A(90), CONV. CORRECT	
9	Δ 8-738-812-05	PICTURE TUBE (A51LPT70X) (KV-PF21M40/PF21P40/PF21P41)		24	4-067-167-21	BRACKET,TERMINAL	
	Δ 8-738-809-05	PICTURE TUBE (A51LPT70X) (KV-PF21L70/PF21M70/PF21P10/PF21Q70)		25	1-452-094-00	CIRCULAR DISC MAGNET B	
10	8-451-505-11	DEFLCETION YOKE (Y21RSA-S) (Except KV-PF21P10)		26	4-069-651-02	BLOTTING SHEET (except KV-PF21L70/Q70)	
	Δ 8-451-505-11	DEFLCETION YOKE (Y21RSA-S) (KV-PF21P10)		27	4-069-651-01	BLOTTING SHEET (KV-PF21L70/Q70)	
11	* A-1331-884-A	C3 BOARD, MOUNTED		28	* A-1241-355-A	F BOARD, MOUNTED	
12	4-369-318-61	SPRING, TENSION			X-4036-750-2	DOOR ASSY, CONTROL (KV-PF21P41)	
13	Δ 1-416-946-21	COIL, DEMAGNETIC			X-4036-753-1	DOOR ASSY, CONTROL (KV-PF21L70)	
14	* 4-067-189-01	PWB(L), GUIDE			X-4036-750-1	DOOR ASSY, CONTROL (KV-PF21M40/M70)	
15	* 4-067-187-01	PWB(R), GUIDE			X-4036-753-3	DOOR ASSY, CONTROL (KV-PF21Q70)	
16	* 8-598-447-00	TUNER, FSS BTF-LG411 (Except KV-PF21M40/M70)		29	Δ 4-070-300-01	COVER, REAR	
	* 8-598-447-10	TUNER, FSS BTF-LG433 (KV-PF21M40/M70)		30	4-064-883-11	HOLDER, DGC	
17	Δ * 1-453-293-11	TRANSFORMER ASSY, FLYBACK (NX-1748/M3A4) (Except KV-PF21M70(ME))		31	* 4-379-189-11	CUSHION, SPEAKER	
	Δ 1-453-298-11	TRANSFORMER ASSY, FLYBACK (NX-1748/M3A4) (KV-PF21M70(ME))		32	4-069-652-02	CUSHION (HS BAND)	
				33	* 4-070-292-01	BAR, OPTICAL	
				34	* A-1347-155-A	V1 BOARD, COMPLETE (KV-PF21P41 only)	
				35	* 4-068-953-02	BRACKET, V1 (KV-PF21P41 only)	
				36	3-704-372-11	HOLDER, HV CABLE (KV-PF21P10)	



SECTION 7

ELECTRICAL PARTS LIST

NOTE:

The components identified by shading and mark Δ are critical for safety. Replace only with part number specified.

When indicating parts by reference number, please include the board name.

• Items marked " * " are not stocked since they are seldom required for routine service. Some delay should be anticipated when ordering these items.

• All variable and adjustable resistors have characteristic curve B, unless otherwise noted.

• All resistors are in ohms
• F : nonflammable

CAPACITORS
• MF : μF, PF : μμF

COILS
• MMH : mH, UH : μH

REF.NO.	PART NO.	DESCRIPTION	REMARK	REF.NO.	PART NO.	DESCRIPTION	REMARK
* A-1298-979-A	A BOARD COMPLETE (KV-PF21L70)			C042	1-163-251-11	CERAMIC CHIP 100PF	5% 50V
* A-1299-009-A	A BOARD COMPLETE (KV-PF21M40)			C043	1-163-251-11	CERAMIC CHIP 100PF	5% 50V
* A-1299-007-A	A BOARD COMPLETE (KV-PF21M70(E))			C044	1-163-251-11	CERAMIC CHIP 100PF	5% 50V
* A-1298-996-A	A BOARD COMPLETE (KV-PF21M70(ME))			C047	1-163-251-11	CERAMIC CHIP 100PF	5% 50V
* A-1298-989-A	A BOARD COMPLETE (KV-PF21P10/PF21P40(MALAYSIA))			C048	1-163-251-11	CERAMIC CHIP 100PF	5% 50V
* A-1298-975-A	A BOARD COMPLETE (KV-PF21P40(SINGAPORE))			C050	1-163-251-11	CERAMIC CHIP 100PF	5% 50V
* A-1299-010-A	A BOARD COMPLETE (KV-PF21P41)			C051	1-163-251-11	CERAMIC CHIP 100PF	5% 50V
* A-1298-978-A	A BOARD COMPLETE (KV-PF21Q70)			C053	1-163-251-11	CERAMIC CHIP 100PF	5% 50V
* 4-055-304-01	HOLDER, LED			C054	1-163-251-11	CERAMIC CHIP 100PF	5% 50V
* 4-067-182-02	HOLDER, FBT			C055	1-163-251-11	CERAMIC CHIP 100PF	5% 50V
4-382-854-11	SCREW (M3X10), P, SW (+)			C103	1-164-004-11	CERAMIC CHIP 0.1MF	10% 25V
4-382-854-21	SCREW (M3X14), P, SW (+)			C104	1-104-665-11	ELECT 100MF	20% 10V
7-685-648-79	SCREW +BVT 3X12 TYPE2 IT-3			C107	1-163-005-11	CERAMIC CHIP 470PF	10% 50V
	<<CAPACITOR>			C108	1-104-664-11	ELECT 47MF	20% 16V
C003	1-163-251-11	CERAMIC CHIP 100PF	5% 50V	C109	1-163-005-11	CERAMIC CHIP 470PF	10% 50V
C004	1-163-001-11	CERAMIC CHIP 220PF	10% 50V	C110	1-163-005-11	CERAMIC CHIP 470PF	10% 50V
C005	1-163-001-11	CERAMIC CHIP 220PF	10% 50V	C111	1-163-005-11	CERAMIC CHIP 470PF	10% 50V
C006	1-164-004-11	CERAMIC CHIP 0.1MF	10% 25V	C112	1-104-664-11	ELECT 47MF	20% 16V
C007	1-104-664-11	ELECT 47MF	20% 16V	C113	1-104-664-11	ELECT 47MF	20% 25V
C008	1-163-251-11	CERAMIC CHIP 100PF	5% 50V	C114	1-126-967-11	ELECT 47MF	20% 50V
C010	1-163-251-11	CERAMIC CHIP 100PF	5% 50V	C202	1-163-021-91	CERAMIC CHIP 0.01MF	10% 50V
C012	1-163-251-11	CERAMIC CHIP 100PF	5% 50V	C204	1-130-481-00	MYLAR 0.0068MF	5% 50V
C013	1-163-021-91	CERAMIC CHIP 0.01MF	10% 50V	C206	1-164-182-11	CERAMIC CHIP 0.0033MF	10% 50V
C014	1-104-664-11	ELECT 47MF	20% 25V	C209	1-126-964-11	ELECT 10MF	20% 50V
C015	1-163-009-11	CERAMIC CHIP 0.001MF	10% 50V	C210	1-126-933-11	ELECT 100MF	20% 16V
C016	1-163-113-00	CERAMIC CHIP 68PF	5% 50V	C211	1-126-941-11	ELECT 470MF	20% 25V
C017	1-163-113-00	CERAMIC CHIP 68PF	5% 50V	C212	1-126-933-11	ELECT 100MF	20% 16V
C019	1-104-664-11	ELECT 47MF	20% 25V	C215	1-126-942-61	ELECT 1000MF	20% 25V
C022	1-163-227-11	CERAMIC CHIP 10PF	0.5PF 50V	C216	1-163-021-91	CERAMIC CHIP 0.01MF	10% 50V
C023	1-163-227-11	CERAMIC CHIP 10PF	0.5PF 50V	C218	1-136-167-00	FILM 0.15MF	5% 50V
C024	1-163-227-11	CERAMIC CHIP 10PF	0.5PF 50V	C220	1-126-942-61	ELECT 1000MF	20% 25V
C026	1-164-004-11	CERAMIC CHIP 0.1MF	10% 25V	C221	1-126-964-11	ELECT 10MF	20% 50V
C027	1-164-004-11	CERAMIC CHIP 0.1MF	10% 25V	C223	1-126-965-11	ELECT 22MF	20% 50V
C028	1-163-037-11	CERAMIC CHIP 0.022MF	10% 50V	C224	1-163-133-00	CERAMIC CHIP 470PF	5% 50V
C030	1-126-965-11	ELECT 22MF	20% 50V	C226	1-109-982-11	CERAMIC CHIP 1MF	10% 10V
C031	1-164-004-11	CERAMIC CHIP 0.1MF	10% 25V	C227	1-163-037-11	CERAMIC CHIP 0.022MF	10% 50V
C032	1-107-823-11	CERAMIC CHIP 0.47MF	10% 16V	C228	1-163-024-00	CERAMIC CHIP 0.018MF	10% 50V
C034	1-163-031-11	CERAMIC CHIP 0.01MF	50V	C229	1-163-018-00	CERAMIC CHIP 0.0056MF	10% 50V
C041	1-163-251-11	CERAMIC CHIP 100PF	5% 50V	C230	1-163-024-00	CERAMIC CHIP 0.018MF	10% 50V
				C231	1-163-018-00	CERAMIC CHIP 0.0056MF	10% 50V
				C232	1-163-037-11	CERAMIC CHIP 0.022MF	10% 50V
				C233	1-164-004-11	CERAMIC CHIP 0.1MF	10% 25V
				C234	1-164-004-11	CERAMIC CHIP 0.1MF	10% 25V
				C235	1-164-004-11	CERAMIC CHIP 0.1MF	10% 25V
				C236	1-164-004-11	CERAMIC CHIP 0.1MF	10% 25V
				C238	1-164-505-11	CERAMIC CHIP 2.2MF	16V
				C240	1-164-505-11	CERAMIC CHIP 2.2MF	16V



The components identified by shading and mark Δ are critical for safety. Replace only with part number specified.

REF. NO.	PART NO.	DESCRIPTION	REMARK	REF. NO.	PART NO.	DESCRIPTION	REMARK
C241	1-164-346-11	CERAMIC CHIP 1MF	16V	C507	1-161-830-00	CERAMIC 0.0047MF	500V
C242	1-164-505-11	CERAMIC CHIP 2.2MF	16V	C510	1-102-112-00	CERAMIC 330PF	10% 50V
C243	1-216-295-91	SHORT 0		C512	1-163-989-11	CERAMIC CHIP 0.033MF	10% 25V
C244	1-164-700-11	CERAMIC CHIP 0.68MF	16V	C513	1-163-263-11	CERAMIC CHIP 330PF	5% 50V
C245	1-164-346-11	CERAMIC CHIP 1MF	16V	C514	1-106-383-00	MYLAR 0.047MF	10% 200V
C246	1-163-018-00	CERAMIC CHIP 0.0056MF	10% 50V	C517	1-164-182-11	CERAMIC CHIP 0.0033MF	10% 50V
C248	1-163-010-11	CERAMIC CHIP 0.0012MF	10% 50V	C518	1-104-665-11	ELECT 100MF	20% 10V
C249	1-164-004-11	CERAMIC CHIP 0.1MF	10% 25V	C519	1-102-212-00	CERAMIC 820PF	10% 500V
C251	1-163-017-00	CERAMIC CHIP 0.0047MF	10% 50V	C521	1-126-934-11	ELECT 220MF	20% 16V
C252	1-164-346-11	CERAMIC CHIP 1MF	16V	C522	1-126-933-11	ELECT 100MF	20% 16V
C253	1-163-037-11	CERAMIC CHIP 0.022MF	10% 50V	C523	1-102-002-00	CERAMIC 680PF	10% 500V
C254	1-126-965-11	ELECT 22MF	20% 50V	C524	1-126-967-11	ELECT 47MF	20% 50V
C255	1-163-037-11	CERAMIC CHIP 0.022MF	10% 50V	C526	1-130-495-00	MYLAR 0.1MF	5% 50V
C256	1-164-004-11	CERAMIC CHIP 0.1MF	10% 25V	C527	1-102-820-00	CERAMIC 330PF	5% 50V
C259	1-126-933-11	ELECT 100MF	20% 16V	C528	1-162-134-11	CERAMIC 470PF	10% 2KV
C265	1-164-505-11	CERAMIC CHIP 2.2MF	16V	C530	1-137-372-11	FILM 0.022MF	5% 50V
C301	1-126-935-11	ELECT 470MF	20% 16V	C531	1-126-961-11	ELECT 2.2MF	20% 50V
C302	1-163-005-11	CERAMIC CHIP 470PF	10% 50V	C532	1-126-941-11	ELECT 470MF	20% 25V
C303	1-126-964-11	ELECT 10MF	20% 50V	C533	1-126-941-11	ELECT 470MF	20% 25V
C304	1-126-967-11	ELECT 47MF	20% 50V	C536	1-136-165-00	FILM 0.1MF	5% 50V
C305	1-164-004-11	CERAMIC CHIP 0.1MF	10% 25V	C537	1-126-969-11	ELECT 220MF	20% 50V
C306	1-163-233-11	CERAMIC CHIP 18PF	5% 50V	C538	1-136-076-00	FILM 0.0085MF	3% 2KV
C307	1-163-233-11	CERAMIC CHIP 18PF	5% 50V	C539	1-129-746-91	FILM 0.039MF	5% 400V
		(Except KV-PF21Q70)		C540	1-136-171-00	FILM 0.33MF	5% 50V
C308	1-163-259-91	CERAMIC CHIP 220PF	5% 50V	C546	1-165-319-11	CERAMIC CHIP 0.1MF	50V
C309	1-126-957-11	ELECT 0.22MF	20% 50V	C549	1-163-017-00	CERAMIC CHIP 0.0047MF	10% 50V
C310	1-126-963-11	ELECT 4.7MF	20% 50V	C550	1-106-220-00	MYLAR 0.1MF	10% 100V
C311	1-126-964-11	ELECT 10MF	20% 50V	C551	1-126-960-11	ELECT 1MF	20% 50V
C312	1-164-346-11	CERAMIC CHIP 1MF	16V	C552	1-162-116-00	CERAMIC 680PF	10% 2KV
C313	1-164-346-11	CERAMIC CHIP 1MF	16V	C553	1-162-116-00	CERAMIC 680PF	10% 2KV
C315	1-164-004-11	CERAMIC CHIP 0.1MF	10% 25V	C554	1-137-417-11	MYLAR 0.0047MF	10% 200V
C316	1-104-664-11	ELECT 47MF	20% 25V	C556	1-126-941-11	ELECT 470MF	20% 25V
C317	1-164-004-11	CERAMIC CHIP 0.1MF	10% 25V	C557	1-126-941-11	ELECT 470MF	20% 25V
C318	1-163-031-11	CERAMIC CHIP 0.01MF	50V	C558	1-123-024-21	ELECT 33MF	160V
C319	1-163-031-11	CERAMIC CHIP 0.01MF	50V	C560	1-102-228-00	CERAMIC 470PF	10% 500V
C320	1-163-031-11	CERAMIC CHIP 0.01MF	50V	C561	1-136-557-11	FILM 0.0033MF	5% 630V
C322	1-163-005-11	CERAMIC CHIP 470PF	10% 50V	C562	1-102-228-00	CERAMIC 470PF	10% 500V
C324	1-163-017-00	CERAMIC CHIP 0.0047MF	10% 50V	C564	1-163-038-91	CERAMIC CHIP 0.1MF	25V
C325	1-126-960-11	ELECT 1MF	20% 50V	C565	1-107-655-11	ELECT 47MF	20% 250V
C327	1-126-965-11	ELECT 22MF	20% 50V	C566	1-102-244-00	CERAMIC 220PF	10% 500V
C328	1-164-004-11	CERAMIC CHIP 0.1MF	10% 25V	C567	1-115-521-11	FILM 0.82MF	5% 250V
C330	1-164-004-11	CERAMIC CHIP 0.1MF	10% 25V	C568	1-102-228-00	CERAMIC 470PF	10% 500V
C332	1-126-963-11	ELECT 4.7MF	20% 50V	C570	1-115-520-11	FILM 0.68MF	5% 250V
C335	1-164-004-11	CERAMIC CHIP 0.1MF	10% 25V	C573	1-106-379-12	MYLAR 0.033MF	10% 200V
C336	1-164-004-11	CERAMIC CHIP 0.1MF	10% 25V	C574	1-107-636-11	ELECT 10MF	20% 160V
C337	1-126-961-11	ELECT 2.2MF	20% 50V	C576	1-130-495-00	MYLAR 0.1MF	5% 50V
C338	1-163-017-00	CERAMIC CHIP 0.0047MF	10% 50V	C577	1-106-395-00	MYLAR 0.15MF	10% 200V
C341	1-115-340-11	CERAMIC CHIP 0.22MF	10% 25V	C582	1-164-004-11	CERAMIC CHIP 0.1MF	10% 25V
C342	1-163-259-91	CERAMIC CHIP 220PF	5% 50V	C586	1-216-295-91	SHORT 0	
C402	1-164-346-11	CERAMIC CHIP 1MF	16V	C600	Δ 1-104-705-51	FILM 0.1MF	20% 250V
C404	1-163-005-11	CERAMIC CHIP 470PF	10% 50V	C602	Δ 1-104-705-51	FILM 0.1MF	20% 250V
C405	1-126-935-11	ELECT 470MF	20% 16V	C604	1-163-009-11	CERAMIC CHIP 0.001MF	10% 50V
C407	1-164-346-11	CERAMIC CHIP 1MF	16V	C605	Δ 1-127-942-51	CERAMIC 330PF	10% 250V
C408	1-163-133-00	CERAMIC CHIP 470PF	5% 50V	C606	Δ 1-127-942-51	CERAMIC 330PF	10% 250V
C409	1-126-963-11	ELECT 4.7MF	20% 50V	C607	1-161-830-00	CERAMIC 0.0047MF	9

The components identified by shading
and mark Δ are critical for safety.
Replace only with part number specified.

A

REF. NO.	PART NO.	DESCRIPTION	REMARK	REF. NO.	PART NO.	DESCRIPTION	REMARK
C610	1-126-964-11	ELECT	10MF 20%	50V	CN305 *	1-564-509-11	PLUG, CONNECTOR 6P
C610	8-719-210-21	DIODE 11EQS04			CN307 *	1-774-813-11	CONNECTOR, BOARD TO BOARD 7P (KV-PF21P41 only)
C611	1-161-830-00	CERAMIC	0.0047MF 99%	500V	CN505	1-508-765-00	PIN, CONNECTOR (5MM PITCH) 3P
C612	1-161-830-00	CERAMIC	0.0047MF 99%	500V	CN506	4-352-844-01	PIN, LEAD, COATING
C613	1-117-752-11	ELECT(BLOCK)	330MF 20%	450V	CN601 *	1-580-843-11	PIN, CONNECTOR (POWER)
C614	1-126-964-11	ELECT	10MF 20%	50V	CN602 *	1-508-786-00	PIN, CONNECTOR (5MM PITCH) 2P
C616	1-130-202-00	FILM	0.022MF 10%	400V	CN604 *	1-573-963-11	PIN, CONNECTOR (PC BOARD) 3P
C617	1-107-792-11	CERAMIC	100PF 5%	1KV	CN609 *	1-508-784-21	PIN, CONNECTOR (5MM PITCH) 1P
C618	1-125-893-11	FILM	680PF 3%	1.5KV	CN901 *	1-564-506-11	PLUG, CONNECTOR 3P
C619 Δ	1-119-886-51	CERAMIC	470PF 10%	250V			
C620	1-163-133-00	CERAMIC CHIP	470PF 5%	50V			
C621	1-102-114-00	CERAMIC	470PF 10%	50V			
C622	1-102-119-00	CERAMIC	0.0015MF 10%	50V			
		(Except KV-PF21M40/PFM70(E)/PF21P41)					
C623	1-104-665-11	ELECT	100MF 20%	25V			
C624	1-125-772-91	CERAMIC	1500PF 10%	2KV			
		(Except KV-PF21M40/PF21M70(E)/PF21P41)					
C627	1-102-002-00	CERAMIC	680PF 10%	500V			
C628	1-126-942-61	ELECT	1000MF 20%	25V			
C629	1-126-964-11	ELECT	10MF 20%	50V			
C630	1-123-024-21	ELECT	33MF 160V				
C633	1-104-999-11	MYLAR	0.1MF 10%	200V			
C634	1-126-933-11	ELECT	100MF 20%	16V			
C635	1-104-665-11	ELECT	100MF 20%	10V			
C636	1-104-760-11	CERAMIC CHIP	0.047MF 10%	50V			
C639	1-164-004-11	CERAMIC CHIP	0.1MF 10%	25V			
C640	1-164-004-11	CERAMIC CHIP	0.1MF 10%	25V			
C641	1-102-002-00	CERAMIC	680PF 10%	500V			
C642	1-126-943-11	ELECT	2200MF 20%	25V			
C643	1-104-665-11	ELECT	100MF 20%	10V			
C644	1-104-331-11	CERAMIC	0.0022MF 10%	1KV			
C645	1-137-605-11	FILM	0.01MF 10%	250V			
C646	1-107-679-91	ELECT	10MF 20%	450V			
C647	1-163-275-11	CERAMIC CHIP	0.001MF 5%	50V			
C649	1-126-940-11	ELECT	330MF 20%	25V			
C650	1-163-275-11	CERAMIC CHIP	0.001MF 5%	50V			
C651	1-163-133-00	CERAMIC CHIP	470PF 5%	50V			
C652	1-126-965-11	ELECT	22MF 20%	50V			
C653	1-104-664-11	ELECT	47MF 20%	25V			
C657	1-101-821-00	CERAMIC	0.0022MF	500V			
C658	1-164-004-11	CERAMIC CHIP	0.1MF 10%	25V			
C901	1-136-153-00	FILM	0.01MF 5%	50V			
C905	1-126-963-11	ELECT	4.7MF 20%	50V			
C906	1-164-346-11	CERAMIC CHIP	1MF	16V			
C907	1-163-133-00	CERAMIC CHIP	470PF 5%	50V			
C910	1-126-967-11	ELECT	47MF 20%	50V			
C911	1-126-967-11	ELECT	47MF 20%	50V			
C912	1-164-004-11	CERAMIC CHIP	0.1MF 10%	25V			
C913	1-104-665-11	ELECT	100MF 20%	10V			
C914	1-163-133-00	CERAMIC CHIP	470PF 5%	50V			
		<<CONNECTOR>					
CN104	1-695-915-11	TAB (CONTACT)					
CN202 *	1-785-608-11	PIN, CONNECTOR 4P					
CN203 *	1-564-506-11	PLUG, CONNECTOR 3P					
CN204 *	1-564-506-11	PLUG, CONNECTOR 3P					
CN301 *	1-774-813-11	CONNECTOR, BOARD TO BOARD 7P (KV-PF21P41 only)					
		<<DIODE>					
D001	8-719-988-61	DIODE 1SS355TE-17					
D005	8-719-988-61	DIODE 1SS355TE-17					
D006	8-719-988-61	DIODE 1SS355TE-17					
D203	8-719-914-42	DIODE DA204K					
D300	1-216-295-91	SHORT		0			
D301	8-719-988-61	DIODE 1SS355TE-17					
D306	8-719-988-61	DIODE 1SS355TE-17					
D307	8-719-988-61	DIODE 1SS355TE-17					
D308	8-719-988-61	DIODE 1SS355TE-17					
D309	8-719-069-54	DIODE UDZS-TE17-5.1B					
D311	8-719-988-61	DIODE 1SS355TE-17					
D312	8-719-988-61	DIODE 1SS355TE-17					
D313	8-719-988-61	DIODE 1SS355TE-17					
D314	8-719-988-61	DIODE 1SS355TE-17					
D315	8-719-988-61	DIODE 1SS355TE-17					
D316	8-719-069-57	DIODE UDZS-TE17-6.8B					
D320	8-719-069-60	DIODE UDZS-TE17-9.1B					
D321	8-719-069-60	DIODE UDZS-TE17-9.1B					
D402	8-719-069-60	DIODE UDZS-TE17-9.1B					
D403	8-719-069-60	DIODE UDZS-TE17-9.1B					
D405	8-719-069-60	DIODE UDZS-TE17-9.1B					
D406	8-719-069-60	DIODE UDZS-TE17-9.1B					
D504	8-719-302-43	DIODE EL1Z					
D505	8-719-988-61	DIODE 1SS355TE-17					
D506	8-719-911-19	DIODE 1SS119-25					
D507	8-719-988-61	DIODE 1SS355TE-17					
D508	8-719-988-61	DIODE 1SS355TE-17					
D509	1-216-073-00	RES.CHIP 10K	5%	1/10W			
D510	8-719-988-61	DIODE 1SS355TE-17					
D511	8-719-988-61	DIODE 1SS355TE-17					
D512	8-719-988-61	DIODE 1SS355TE-17					
D513	8-719-908-03	DIODE GP08D					
D517	8-719-312-71	DIODE RS3FS					
D518	8-719-900-26	DIODE ERD29-08J					
D521	8-719-302-43	DIODE EL1Z					
D522	8-719-302-43	DIODE EL1Z					
D523	8-719-302-43	DIODE EL1Z					
D527	8-719-908-03	DIODE GP08D					
D528	8-719-908-03	DIODE GP08D					
D531	8-719-988-61	DIODE 1SS355TE-17					
D532	8-719-988-61	DIODE 1SS355TE-17					
D534	1-216-295-91	SHORT		0			
D602	8-719-911-19	DIODE 1SS119-25					
D603	8-719-150-92	DIODE RD33EB3T					
D604	8-719-028-72	DIODE RGP02-17EL-6433					



REF. NO.	PART NO.	DESCRIPTION	REMARK	REF. NO.	PART NO.	DESCRIPTION	REMARK
D605	8-719-510-53	DIODE D4SB60L		IC203	8-759-553-40	IC TDA7429S	
D606	8-719-108-18	THYRISTOR 5P6M		IC301	8-752-088-39	IC CXA2130S	
D607	8-719-073-01	DIODE MA111-(K8).S0		IC502	8-759-700-07	IC NJM2903M	
D608	8-719-110-53	DIODE RD20ESB2		IC503	8-759-980-58	IC TDA8172	
D609	8-719-311-31	DIODE RU-1P		IC601	8-749-013-75	IC STR-F6654	
D611	8-719-046-74	DIODE AU-01Z-V1		IC602	8-749-920-61	IC SE-135N	
D613	8-719-046-74	DIODE AU-01Z-V1		IC603	8-759-701-59	IC NJM78M09FA	
D614	8-719-046-74	DIODE AU-01Z-V1		IC604	8-759-231-53	IC TA7805S	
D618	8-719-067-18	DIODE RN4Z		IC901	8-742-014-11	HYB IC SBX1981-51	
D620	8-719-110-72	DIODE RD30ESB2				<<JACK>	
D622	8-719-071-39	DIODE FMU-G26S					
D623	8-719-978-65	DIODE DTZ-TT11-15B		J401	1-779-849-11	JACK BLOCK, PIN 4P	
D624	8-719-073-01	DIODE MA111-(K8).S0		J901	1-770-785-11	JACK	
D625	8-719-977-28	DIODE DTZ10B		J902	1-779-205-11	JACK, PIN 2P	
D627	8-719-073-84	DIODE 31DQ06-FC5				<<CHIP CONDUCTOR>	
D628	8-719-911-19	DIODE ISS119-25		JR001	1-216-295-91	SHORT	0
D631	8-719-068-00	DIODE ERC04-06SE		JR002	1-216-295-91	SHORT	0
D632	8-719-068-00	DIODE ERC04-06SE		JR003	1-216-295-91	SHORT	0
D633	8-719-030-25	DIODE EG01CV0		JR004	1-216-295-91	SHORT	0
D634	8-719-073-01	DIODE MA111-(K8).S0		JR005	1-216-295-91	SHORT	0
D635	8-719-073-01	DIODE MA111-(K8).S0		JR006	1-216-295-91	SHORT	0
D636	8-719-510-02	DIODE D1NS4		JR007	1-216-295-91	SHORT	0
D637	8-719-109-96	DIODE RD6.8ESB1		JR008	1-216-295-91	SHORT	0
D638	8-719-024-99	DIODE 11ES2-NTA2B		JR009	1-216-295-91	SHORT	0
D901	8-719-069-60	DIODE UDZS-TE17-9.1B		JR010	1-216-295-91	SHORT	0
D902	8-719-069-60	DIODE UDZS-TE17-9.1B		JR011	1-216-295-91	SHORT	0
D904	8-719-069-60	DIODE UDZS-TE17-9.1B		JR012	1-216-295-91	SHORT	0
D905	8-719-069-60	DIODE UDZS-TE17-9.1B		JR013	1-216-295-91	SHORT	0
D906	8-719-045-19	DIODE SPB-26MVWF		JR014	1-216-295-91	SHORT	0
		<<CONNECTOR>		JR015	1-216-295-91	SHORT	0
DY1	* 1-580-798-11	CONNECTOR PIN (DY) 6P		JR016	1-216-295-91	SHORT	0
		<<FERRITE BEAD>		JR018	1-216-295-91	SHORT	0
FB501	1-410-397-21	FERRITE 1.1UH		JR019	1-216-295-91	SHORT	0
FB502	1-410-397-21	FERRITE 1.1UH		JR102	1-216-295-91	SHORT	0
FB600	1-410-397-21	FERRITE 1.1UH		JR109	1-216-295-91	SHORT	0
FB601	1-410-397-21	FERRITE 1.1UH		JR202	1-216-295-91	SHORT	0
FB602	1-410-397-21	FERRITE 1.1UH		JR301	1-216-295-91	SHORT	0
FB603	1-410-397-21	FERRITE 1.1UH		JR303	1-216-295-91	SHORT	0
FB604	1-410-397-21	FERRITE 1.1UH		JR404	1-216-295-91	SHORT	0
FB607	1-410-397-21	FERRITE 1.1UH		JR405	1-216-295-91	SHORT	0
FB608	1-410-397-21	FERRITE 1.1UH		JR500	1-216-295-91	SHORT	0
FB611	1-410-397-21	FERRITE 1.1UH		JR501	1-216-295-91	SHORT	0
FB613	1-410-397-21	FERRITE 1.1UH		JR503	1-216-295-91	SHORT	0
FB615	1-410-397-21	FERRITE 1.1UH		JR600	1-216-295-91	SHORT	0
		<<IC>				<<COIL>	
IC001	8-752-906-20	IC CXP86449-622S (KV-PF21L70/PF21Q70)/M70(ME)		L002	1-414-856-11	INDUCTOR 10UH	
IC001	8-752-906-21	IC CXP86449-623S (Except KV-PF21L70/PF21Q70/M70(ME))		L003	1-414-180-11	INDUCTOR 3.3UH	
IC002	8-759-371-21	IC MM1319AFBE		L005	1-414-233-22	INDUCTOR CHIP 0UH	
IC003	8-759-527-71	IC M24C08-BN6		L101	1-414-856-11	INDUCTOR 10UH	
IC201	8-759-339-60	IC TA8248K		L102	1-414-856-11	INDUCTOR 10UH	
				L103	1-414-856-11	INDUCTOR 10UH	
				L104	1-414-856-11	INDUCTOR 10UH	
				L105	1-414-856-11	INDUCTOR 10UH	

The components identified by shading
and mark \triangle are critical for safety.
Replace only with part number specified.

A

REF. NO.	PART NO.	DESCRIPTION	REMARK	REF. NO.	PART NO.	DESCRIPTION	REMARK
L204	1-414-856-11	INDUCTOR	10UH	Q509	8-729-230-49	TRANSISTOR 2SC2712-YG	
L301	1-414-189-31	INDUCTOR	100UH	Q511	8-729-048-07	TRANSISTOR 2SD2578-CA	
L302	1-414-185-41	INDUCTOR	22UH	Q601	8-729-023-22	TRANSISTOR 2SD2114K	
L501	1-412-525-31	INDUCTOR	10UH	Q602	8-729-230-49	TRANSISTOR 2SC2712-YG	
L502	1-422-613-11	COIL, AIR CORE		Q603	8-729-424-08	TRANSISTOR UN2111	
L503	1-412-525-31	INDUCTOR	10UH	Q604	8-729-200-17	TRANSISTOR 2SA1091-O	
L504	1-412-525-31	INDUCTOR	10UH	Q605	8-729-044-30	TRANSISTOR 2SK2845-LB102	
L505	1-412-525-31	INDUCTOR	10UH	Q606	8-729-230-49	TRANSISTOR 2SC2712-YG	
L506	1-412-525-31	INDUCTOR	10UH	Q606	8-729-120-28	TRANSISTOR 2SC1623-L5L6	
L507	1-459-111-00	INDUCTOR	10MMH	Q607	8-729-922-37	TRANSISTOR 2SD2144S-UVW	
L508	1-412-525-31	INDUCTOR	10UH	Q608	8-729-230-49	TRANSISTOR 2SC2712-YG	
L509	1-459-390-00	INDUCTOR	390UH	Q901	8-729-421-19	TRANSISTOR UN2213	
L510	1-416-972-11	COIL, HORIZONTAL LINEARITY		Q902	8-729-421-19	TRANSISTOR UN2213	
L512	1-412-549-31	INDUCTOR	1MMH			<<RESISTOR>	
L513	1-412-549-31	INDUCTOR	1MMH	R001	1-414-233-22	INDUCTOR CHIP	0UH
L515	1-459-104-00	COIL, WITH CORE		R002	1-216-025-91	RES,CHIP	100 5% 1/10W
L518	1-414-187-11	INDUCTOR	47UH	R003	1-216-295-91	SHORT	0
L601	1-412-527-11	INDUCTOR	15UH	R004	1-216-025-91	RES,CHIP	100 5% 1/10W
L901	1-408-603-31	INDUCTOR	10UH	R005	1-216-025-91	RES,CHIP	100 5% 1/10W
L905	1-414-856-11	INDUCTOR	10UH	R007	1-216-295-91	SHORT	0
		<<PHOTO COUPLER>		R008	1-216-065-91	RES,CHIP	4.7K 5% 1/10W
PH600 \triangle	8-749-010-64	PHOTO COUPLER PC123F2		R010	1-216-065-91	RES,CHIP	4.7K 5% 1/10W
		<<IC LINK>		R011	1-216-065-91	RES,CHIP	4.7K 5% 1/10W
PS200	1-532-675-21	LINK, IC 1.5A/150V		R012	1-216-065-91	RES,CHIP	4.7K 5% 1/10W
		<<TRANSISTOR>		R013	1-216-065-91	RES,CHIP	4.7K 5% 1/10W
Q002	8-729-230-49	TRANSISTOR 2SC2712-YG		R014	1-216-025-91	RES,CHIP	100 5% 1/10W
Q003	8-729-424-08	TRANSISTOR UN2111		R015	1-216-025-91	RES,CHIP	100 5% 1/10W
Q004	8-729-421-22	TRANSISTOR UN2211		R017	1-216-049-91	RES,CHIP	1K 5% 1/10W
Q101	8-729-230-49	TRANSISTOR 2SC2712-YG		R018	1-216-033-00	RES,CHIP	220 5% 1/10W
Q201	8-729-424-67	TRANSISTOR UN2216		R019	1-216-073-00	RES,CHIP	10K 5% 1/10W
Q203	8-729-421-19	TRANSISTOR UN2213		R021	1-216-073-00	RES,CHIP	10K 5% 1/10W
Q204	8-729-216-22	TRANSISTOR 2SA1162-G		R022	1-216-033-00	RES,CHIP	220 5% 1/10W
Q206	8-729-421-19	TRANSISTOR UN2213		R024	1-216-057-00	RES,CHIP	2.2K 5% 1/10W
Q207	8-729-421-19	TRANSISTOR UN2213		R025	1-216-057-00	RES,CHIP	2.2K 5% 1/10W
Q301	8-729-216-22	TRANSISTOR 2SA1162-G		R026	1-216-057-00	RES,CHIP	2.2K 5% 1/10W
Q302	8-729-230-49	TRANSISTOR 2SC2712-YG		R027	1-216-073-00	RES,CHIP	10K 5% 1/10W
Q303	8-729-216-22	TRANSISTOR 2SA1162-G		R029	1-216-049-91	RES,CHIP	1K 5% 1/10W
Q305	8-729-216-22	TRANSISTOR 2SA1162-G		R031	1-216-049-91	RES,CHIP	1K 5% 1/10W
Q306	8-729-216-22	TRANSISTOR 2SA1162-G		R035	1-216-025-91	RES,CHIP	100 5% 1/10W
Q307	8-729-230-49	TRANSISTOR 2SC2712-YG		R036	1-216-025-91	RES,CHIP	100 5% 1/10W
Q308	8-729-216-22	TRANSISTOR 2SA1162-G		R037	1-216-025-91	RES,CHIP	100 5% 1/10W
Q312	8-729-216-22	TRANSISTOR 2SA1162-G		R040	1-216-025-91	RES,CHIP	100 5% 1/10W
Q313	8-729-230-49	TRANSISTOR 2SC2712-YG		R041	1-216-025-91	RES,CHIP	100 5% 1/10W
Q315	8-729-421-19	TRANSISTOR UN2213		R042	1-216-295-91	SHORT	0
Q401	8-729-424-67	TRANSISTOR UN2216		R043	1-216-049-91	RES,CHIP	1K 5% 1/10W
Q404	8-729-216-22	TRANSISTOR 2SA1162-G		R044	1-216-025-91	RES,CHIP	100 5% 1/10W
Q503	8-729-230-49	TRANSISTOR 2SC2712-YG		R045	1-414-233-22	INDUCTOR CHIP	0UH
Q505	8-729-931-45	TRANSISTOR IRF614		R046	1-216-049-91	RES,CHIP	1K 5% 1/10W
Q506	8-729-140-96	TRANSISTOR 2SD774-34		R047	1-414-233-22	INDUCTOR CHIP	0UH
Q507	8-729-216-22	TRANSISTOR 2SA1162-G		R048	1-216-073-00	RES,CHIP	10K 5% 1/10W
				R050	1-216-073-00	RES,CHIP	10K 5% 1/10W
				R053	1-216-049-91	RES,CHIP	1K 5% 1/10W
				R055	1-216-073-00	RES,CHIP	10K 5% 1/10W
				R056	1-216-073-00	RES,CHIP	10K 5% 1/10W

**KV-PF21L70/PF21M40/PF21M70/PF21P10
KV-PF21P40/PF21P41/PF21Q70**

RM-952



REF. NO.	PART NO.	DESCRIPTION	REMARK	REF. NO.	PART NO.	DESCRIPTION	REMARK
R061	1-216-033-00	RES,CHIP	220 5%	R331	1-216-295-91	SHORT	0
R062	1-216-041-00	RES,CHIP	470 5%	R332	1-216-033-00	RES,CHIP	220 5%
R063	1-216-037-00	RES,CHIP	330 5%	R333	1-216-073-00	RES,CHIP	10K 5%
R064	1-216-037-00	RES,CHIP	330 5%	R334	1-216-129-00	RES,CHIP	2.2M 5%
R065	1-216-037-00	RES,CHIP	330 5%	R335	1-216-045-00	RES,CHIP	680 5%
R066	1-216-049-91	RES,CHIP	1K 5%	R338	1-216-033-00	RES,CHIP	220 5%
R067	1-216-049-91	RES,CHIP	1K 5%	R340	1-216-025-91	RES,CHIP	100 5%
R105	1-216-295-91	SHORT	0	R345	1-216-081-00	RES,CHIP	22K 5%
R109	1-216-041-00	RES,CHIP	470 5%	R348	1-208-806-11	RES,CHIP	10K 0.50%
R111	1-216-025-91	RES,CHIP	100 5%	R349	1-216-073-00	RES,CHIP	10K 5%
R112	1-216-025-91	RES,CHIP	100 5%	R350	1-216-061-00	RES,CHIP	3.3K 5%
R113	1-216-047-91	RES,CHIP	820 5%	R351	1-216-053-00	RES,CHIP	1.5K 5%
R202	1-216-071-00	RES,CHIP	8.2K 5%	R354	1-216-057-00	RES,CHIP	2.2K 5%
R203	1-216-077-00	RES,CHIP	15K 5%	R355	1-216-057-00	RES,CHIP	2.2K 5%
R204	1-216-071-00	RES,CHIP	8.2K 5%	R356	1-216-057-00	RES,CHIP	2.2K 5%
R208	1-216-073-00	RES,CHIP	10K 5%	R357	1-216-079-00	RES,CHIP	18K 5%
R210	1-164-004-11	CERAMIC CHIP	0.1MF 10%	R358	1-216-049-91	RES,CHIP	1K 5%
R211	1-216-043-91	RES,CHIP	560 5%	R359	1-216-033-00	RES,CHIP	220 5%
R212	1-216-033-00	RES,CHIP	220 5%	R360	1-216-033-00	RES,CHIP	220 5%
R213	1-216-073-00	RES,CHIP	10K 5%	R361	1-216-073-00	RES,CHIP	10K 5%
R214	1-216-073-00	RES,CHIP	10K 5%	R362	1-216-075-00	RES,CHIP	12K 5%
R215	1-216-059-00	RES,CHIP	2.7K 5%	R363	1-216-079-00	RES,CHIP	18K 5%
R216	1-216-059-00	RES,CHIP	2.7K 5%	R364	1-216-295-91	SHORT	0
R217	1-216-067-00	RES,CHIP	5.6K 5%	R365	1-216-033-00	RES,CHIP	220 5%
R218	1-216-067-00	RES,CHIP	5.6K 5%	R366	1-216-073-00	RES,CHIP	10K 5%
R219	1-216-025-91	RES,CHIP	100 5%	R367	1-216-073-00	RES,CHIP	10K 5%
R220	1-216-025-91	RES,CHIP	100 5%	R370	1-216-033-00	RES,CHIP	220 5%
R221	1-216-295-91	SHORT	0	R375	1-216-025-91	RES,CHIP	100 5%
R225	1-216-033-00	RES,CHIP	220 5%	(KV-PF21P41 only)			
R226	1-216-033-00	RES,CHIP	220 5%	R376	1-216-081-00	RES,CHIP	22K 5%
R227	1-216-033-00	RES,CHIP	220 5%	R377	1-216-121-91	RES,CHIP	1M 5%
R229	1-216-073-00	RES,CHIP	10K 5%	R378	1-216-031-00	RES,CHIP	180 5%
R231	1-216-295-91	SHORT	0	R404	1-216-073-00	RES,CHIP	10K 5%
R234	1-249-389-11	CARBON	4.7 5%	R405	1-216-049-91	RES,CHIP	1K 5%
R235	1-216-069-00	RES,CHIP	6.8K 5%	R406	1-216-073-00	RES,CHIP	10K 5%
R236	1-216-069-00	RES,CHIP	6.8K 5%	R408	1-216-049-91	RES,CHIP	1K 5%
R237	1-216-308-00	RES,CHIP	4.7 5%	R411	1-216-113-00	RES,CHIP	470K 5%
R301	1-216-073-00	RES,CHIP	10K 5%	R412	1-216-041-00	RES,CHIP	470 5%
R302	1-216-295-91	SHORT	0	R413	1-216-021-00	RES,CHIP	68 5%
R303	1-216-049-91	RES,CHIP	1K 5%	R414	1-216-113-00	RES,CHIP	470K 5%
R304	1-216-073-00	RES,CHIP	10K 5%	R417	1-216-077-00	RES,CHIP	15K 5%
R305	1-216-051-00	RES,CHIP	1.2K 5%	R418	1-216-113-00	RES,CHIP	470K 5%
R306	1-216-073-00	RES,CHIP	10K 5%	R419	1-216-022-00	RES,CHIP	75 5%
R308	1-216-025-91	RES,CHIP	100 5%	R426	1-216-033-00	RES,CHIP	220 5%
R309	1-216-025-91	RES,CHIP	100 5%	R505	1-216-099-00	RES,CHIP	120K 5%
R310	1-216-025-91	RES,CHIP	100 5%	R506	1-216-085-00	RES,CHIP	33K 5%
R311	1-216-017-91	RES,CHIP	47 5%	R507	1-249-389-11	CARBON	4.7 5%
R312	1-216-041-00	RES,CHIP	470 5%	R508	1-215-910-00	METAL OXIDE	68 5%
R313	1-216-053-00	RES,CHIP	1.5K 5%	R509	1-215-911-11	METAL OXIDE	100 5%
R314	1-216-045-00	RES,CHIP	680 5%	R510	1-215-885-00	METAL OXIDE	68 5%
R316	1-216-053-00	RES,CHIP	1.5K 5%	R511	1-215-911-11	METAL OXIDE	100 5%
R317	1-216-077-00	RES,CHIP	15K 5%	R516	1-216-081-00	RES,CHIP	22K 5%
R318	1-216-051-00	RES,CHIP	1.2K 5%	R518	1-247-807-31	CARBON	100 5%
R319	1-216-025-91	RES,CHIP	100 5%	R520	1-215-445-00	METAL	10K 1%
R320	1-216-065-91	RES,CHIP	4.7K 5%	R522	1-208-806-11	RES,CHIP	10K 0.50%
R321	1-216-073-00	RES,CHIP	10K 5%	R523	1-249-411-11	CARBON	330 5%
R322	1-216-033-00	RES,CHIP	220 5%	R525	1-208-830-11	RES,CHIP	100K 0.50%

The components identified by shading
and mark Δ are critical for safety.
Replace only with part number specified.

A

REF. NO.	PART NO.	DESCRIPTION		REMARK	REF. NO.	PART NO.	DESCRIPTION		REMARK
R526	1-208-798-11	RES,CHIP	4.7K	0.50% 1/10W	R610	1-216-073-00	RES,CHIP	10K	5% 1/10W
R527	1-216-001-00	RES,CHIP	10	5% 1/10W	R611	1-216-089-91	RES,CHIP	47K	5% 1/10W
R528	1-208-814-91	RES,CHIP	22K	0.50% 1/10W	R612	1-216-045-00	RES,CHIP	680	5% 1/10W
R529	1-208-766-11	RES,CHIP	220	0.50% 1/10W	R614	1-216-041-00	RES,CHIP	470	5% 1/10W
R531	1-247-843-11	CARBON	3.3K	5% 1/4W	R615	1-216-350-11	METAL OXIDE	1.2	5% 1W F
R533	1-249-417-11	CARBON	1K	5% 1/4W	R616	1-260-302-51	CARBON	6.8	5% 1/2W F
R534	1-216-361-00	METAL OXIDE	0.22	5% 2W F	R617	1-247-791-91	CARBON	22	5% 1/4W
R535	1-216-067-00	RES,CHIP	5.6K	5% 1/10W	R619	1-260-128-11	CARBON	270K	5% 1/2W
R536	1-216-067-00	RES,CHIP	5.6K	5% 1/10W	R620	1-215-915-11	METAL OXIDE	470	5% 3W F
R537	1-208-814-91	RES,CHIP	22K	0.50% 1/10W	R622	1-215-908-00	METAL OXIDE	33	5% 3W F
R540	1-216-065-91	RES,CHIP	4.7K	5% 1/10W	R623	1-216-095-00	RES,CHIP	82K	5% 1/10W
R541	1-216-065-91	RES,CHIP	4.7K	5% 1/10W	R624	1-216-089-91	RES,CHIP	47K	5% 1/10W
R542	1-216-295-91	SHORT	0		R626	1-216-049-91	RES,CHIP	1K	5% 1/10W
R543	1-249-426-11	CARBON	5.6K	5% 1/4W F	R627	1-240-251-11	CMT,MELF	6.8	5% 10W
R545	1-216-077-00	RES,CHIP	15K	5% 1/10W	R629	1-247-747-11	CARBON	470	5% 1/2W F
R546	1-216-077-00	RES,CHIP	15K	5% 1/10W	R630	1-249-429-11	CARBON	10K	5% 1/4W F
R547	1-216-085-00	RES,CHIP	33K	5% 1/10W	R631	1-216-089-91	RES,CHIP	47K	5% 1/10W
R549	1-215-451-00	METAL	18K	1% 1/4W	R632	1-202-933-61	FUSIBLE	0.1	10% 1/2W F
R550	1-216-097-91	RES,CHIP	100K	5% 1/10W	R634 Δ	1-218-265-11	METAL	8.2M	5% 1W
R551	1-249-421-11	CARBON	2.2K	5% 1/4W	R635	1-216-492-11	METAL OXIDE	82K	5% 3W F
R552	1-216-057-00	RES,CHIP	2.2K	5% 1/10W	R636	1-215-924-00	METAL OXIDE	15K	5% 3W F
R553	1-215-457-00	METAL	33K	1% 1/4W	R637	1-216-492-11	METAL OXIDE	82K	5% 3W F
R554	1-215-457-00	METAL	33K	1% 1/4W	R639	1-216-363-00	METAL OXIDE	0.33	5% 2W F
R556	1-215-437-00	METAL	4.7K	1% 1/4W	R640	1-249-415-11	CARBON	680	5% 1/4W
R558	1-249-421-11	CARBON	2.2K	5% 1/4W	R641	1-216-362-11	METAL OXIDE	0.27	5% 2W F
R559	1-249-429-11	CARBON	10K	5% 1/4W	R642	1-249-419-11	CARBON	1.5K	5% 1/4W
R560	1-216-073-00	RES,CHIP	10K	5% 1/10W	R643	1-247-843-11	CARBON	3.3K	5% 1/4W
R562	1-249-401-11	CARBON	47	5% 1/4W	R644	1-249-419-11	CARBON	1.5K	5% 1/4W
R565	1-216-073-00	RES,CHIP	10K	5% 1/10W	R646	1-215-924-00	METAL OXIDE	15K	5% 3W F
R567	1-216-105-91	RES,CHIP	220K	5% 1/10W	R647	1-249-401-11	CARBON	47	5% 1/4W
R568	1-249-383-11	CARBON	1.5	5% 1/4W F	R648	1-216-057-00	RES,CHIP	2.2K	5% 1/10W
R570	1-216-069-00	RES,CHIP	6.8K	5% 1/10W	R649	1-249-417-11	CARBON	1K	5% 1/4W
R571	1-215-437-00	METAL	4.7K	1% 1/4W	R650	1-215-882-00	METAL OXIDE	22	5% 2W F
R573	1-216-089-91	RES,CHIP	47K	5% 1/10W	R652	1-215-900-11	METAL OXIDE	22K	5% 2W F
R577	1-215-913-11	METAL OXIDE	220	5% 3W F	R653	1-215-873-00	METAL OXIDE	4.7K	5% 1W F
R578	1-216-369-00	METAL OXIDE	1	5% 2W F	R657	1-260-127-11	CARBON	220K	5% 1/2W
R579	1-216-097-91	RES,CHIP	100K	5% 1/10W	R659	1-216-049-91	RES,CHIP	1K	5% 1/10W
R580	1-208-830-11	RES,CHIP	100K	0.50% 1/10W	R660	1-216-073-00	RES,CHIP	10K	5% 1/10W
R581	1-208-798-11	RES,CHIP	4.7K	0.50% 1/10W	R661	1-215-873-00	METAL OXIDE	4.7K	5% 1W F
R585	1-249-391-11	CARBON	6.8	5% 1/4W F	R901	1-249-411-11	CARBON	330	5% 1/4W
R588	1-215-888-00	METAL OXIDE	220	5% 2W F	R903	1-216-022-00	RES,CHIP	75	5% 1/10W
R589	1-215-888-00	METAL OXIDE	220	5% 2W F	R904	1-216-033-00	RES,CHIP	220	5% 1/10W
R590	1-215-465-00	METAL	68K	1% 1/4W	R905	1-216-113-00	RES,CHIP	470K	5% 1/10W
R591	1-260-288-11	CARBON	0.47	5% 1/2W F	R906	1-216-077-00	RES,CHIP	15K	5% 1/10W
R593	1-260-288-11	CARBON	0.47	5% 1/2W F	R909	1-216-065-91	RES,CHIP	4.7K	5% 1/10W
R594	1-260-288-11	CARBON	0.47	5% 1/2W F	R910	1-216-065-91	RES,CHIP	4.7K	5% 1/10W
R596	1-215-922-11	METAL OXIDE	6.8K	5% 3W F	R911	1-216-067-00	RES,CHIP	5.6K	5% 1/10W
R597	1-247-750-11	CARBON	680	5% 1/2W F	R912	1-216-041-00	RES,CHIP	470	5% 1/10W
R598	1-249-438-11	CARBON	56K	5% 1/4W	R913	1-216-049-91	RES,CHIP	1K	5% 1/10W
R599	1-249-389-11	CARBON	4.7	5% 1/4W	R914	1-216-055-00	RES,CHIP	1.8K	5% 1/10W
R600	1-249-438-11	CARBON	56K	5% 1/4W	R915	1-216-061-00	RES,CHIP	3.3K	5% 1/10W
R601	1-249-418-11	CARBON	1.2K	5% 1/4W F	R916	1-216-017-91	RES,CHIP	47	5% 1/10W
R602	1-249-389-11	CARBON	4.7	5% 1/4W F	R917	1-216-041-00	RES,CHIP	470	5% 1/10W
R603	1-215-485-00	METAL	470K	1% 1/4W	R918	1-216-041-00	RES,CHIP	470	5% 1/10W
R604	1-216-097-91	RES,CHIP	100K	5% 1/10W					
R607	1-249-425-11	CARBON	4.7K	5% 1/4W					
R608	1-240-205-91	CARBON	22M	5% 1/2W					
R609	1-216-057-00	RES,CHIP	2.2K	5% 1/10W					

**KV-PF21L70/PF21M40/PF21M70/PF21P10
KV-PF21P40/PF21P41/PF21Q70**

RM-952



The components identified by shading and mark Δ are critical for safety. Replace only with part number specified.

REF. NO.	PART NO.	DESCRIPTION	REMARK
		<<RELAY>	
R	RY601 Δ 1-755-266-11	RELAY, AC POWER	
		<<SWITCH>	
S	S502 1-572-707-11	SWITCH, LEVER	
S	S600 Δ 1-571-433-21	SWITCH, PUSH (AC POWER)	
S	S901 1-692-431-21	SWITCH, TACTILE	
S	S902 1-692-431-21	SWITCH, TACTILE	
S	S903 1-692-431-21	SWITCH, TACTILE	
S	S904 1-692-431-21	SWITCH, TACTILE	
S	S905 1-692-431-21	SWITCH, TACTILE	
S	S906 1-692-431-21	SWITCH, TACTILE	
S	S907 1-692-431-21	SWITCH, TACTILE	
		<<TRANSFORMER>	
T	T501 1-437-195-11	TRANSFORMER, HORIZONTAL DRIVE	
T	T503 Δ 1-453-293-11	TRANSFORMER ASSY, FLYBACK (NX-1748/M3A4) (Except KV-PF21M70(ME))	
T	T503 Δ 1-453-298-11	TRANSFORMER ASSY, FLYBACK (NX-1748/M3A4) (KV-PF21M70(ME))	
T	T601 1-424-682-11	TRANSFORMER, LINE FILTER	
T	T603 Δ 1-433-512-31	TRANSFORMER, CONVERTER (SRT)	
T	T604 Δ 1-431-852-11	TRANSFORMER, CONVERTER (SRT)	
		<<THERMISTOR>	
THP	THP600 1-810-961-11	THERMISTOR, POSITIVE	
		<<TUNER>	
TU	TU101 8-598-447-00	TUNER, FSS BTF-LG411 (Except KV-PF21M40/ PF21M70)	
TU	TU101 8-598-449-10	TUNER, FSS BTF-LG433 (KV-PF21M40/PF21M70)	
		<<CRYSTAL>	
X	X001 1-579-125-11	VIBRATOR, CERAMIC	
X	X301 1-781-134-21	VIBRATOR, CRYSTAL	
X	X302 1-781-132-21	VIBRATOR, CRYSTAL (Except KV-PF21Q70)	

	* A-1331-884-A	C3 BOARD, MOUNTED *****	
	7-682-948-01	SCREW +PSW 3X8	
		<<CAPACITOR>	
C	C701 1-162-114-00	CERAMIC 0.0047MF 2KV	
C	C702 1-102-074-00	CERAMIC 0.001MF 10% 50V	
C	C703 1-107-651-11	ELECT 4.7MF 20% 250V	
C	C704 1-130-202-00	FILM 0.022MF 5% 400V	
C	C706 1-104-664-11	ELECT 47MF 20% 16V	

REF. NO.	PART NO.	DESCRIPTION	REMARK
C	C708 1-102-114-00	CERAMIC 470PF 10% 50V	
C	C709 1-102-114-00	CERAMIC 470PF 10% 50V	
C	C710 1-102-114-00	CERAMIC 470PF 10% 50V	
C	C712 1-102-116-00	CERAMIC 680PF 10% 50V	
C	C713 1-102-116-00	CERAMIC 680PF 10% 50V	
C	C714 1-102-116-00	CERAMIC 680PF 10% 50V	
C	C716 1-126-933-11	ELECT 100MF 20% 16V	
C	C717 1-101-880-00	CERAMIC 47PF 5% 50V	
C	C736 1-102-114-00	CERAMIC 470PF 10% 50V	
C	C737 1-102-114-00	CERAMIC 470PF 10% 50V	
C	C746 1-102-114-00	CERAMIC 470PF 10% 50V	
		<<CONNECTOR>	
CN	CN701 1-508-765-00	PIN, CONNECTOR (5MM PITCH) 3P	
CN	CN702 1-695-915-11	TAB (CONTACT)	
CN	CN703 * 1-564-509-11	PLUG, CONNECTOR 6P	
CN	CN704 1-695-915-11	TAB (CONTACT)	
		<<DIODE>	
D	D701 8-719-911-19	DIODE 1SS119-25	
D	D702 8-719-911-19	DIODE 1SS119-25	
D	D703 8-719-911-19	DIODE 1SS119-25	
D	D707 8-719-911-19	DIODE 1SS119-25	
D	D708 8-719-911-19	DIODE 1SS119-25	
D	D709 8-719-911-19	DIODE 1SS119-25	
D	D710 8-719-911-19	DIODE 1SS119-25	
D	D711 8-719-911-19	DIODE 1SS119-25	
D	D712 8-719-911-19	DIODE 1SS119-25	
D	D713 8-719-911-19	DIODE 1SS119-25	
D	D714 8-719-911-19	DIODE 1SS119-25	
D	D715 8-719-911-19	DIODE 1SS119-25	
D	D716 8-719-911-19	DIODE 1SS119-25	
D	D717 8-719-121-26	DIODE RD9.1ESL2	
		<<JACK>	
J	J701 Δ 1-540-071-22	SOCKET, CRT	
		<<COIL>	
L	L701 1-410-667-31	INDUCTOR 22UH	
L	L710 1-408-613-31	INDUCTOR 68UH	
L	L711 1-408-613-31	INDUCTOR 68UH	
L	L712 1-408-613-31	INDUCTOR 68UH	
		<<TRANSISTOR>	
Q	Q704 8-729-326-11	TRANSISTOR 2SC2611	
Q	Q705 8-729-326-11	TRANSISTOR 2SC2611	
Q	Q706 8-729-326-11	TRANSISTOR 2SC2611	
Q	Q707 8-729-200-17	TRANSISTOR 2SA1091-O	
Q	Q708 8-729-200-17	TRANSISTOR 2SA1091-O	
Q	Q709 8-729-200-17	TRANSISTOR 2SA1091-O	
Q	Q710 8-729-119-78	TRANSISTOR 2SC2785-HFE	
Q	Q711 8-729-119-78	TRANSISTOR 2SC2785-HFE	
Q	Q712 8-729-119-78	TRANSISTOR 2SC2785-HFE	

The components identified by shading and mark Δ are critical for safety. Replace only with part number specified.



REF. NO.	PART NO.	DESCRIPTION	REMARK
<<RESISTOR>			
R703	1-249-496-11	CARBON 100K	5% 1/2W
R705	1-216-380-11	METAL OXIDE 8.2	5% 2W F
R706	1-215-417-00	METAL 680	1% 1/4W
R707	1-215-413-00	METAL 470	1% 1/4W
R708	1-216-379-11	METAL OXIDE 6.8	5% 2W F
R710	1-215-922-11	METAL OXIDE 6.8K	5% 3W F
R711	1-247-752-11	CARBON 1K	5% 1/2W
R712	1-215-922-11	METAL OXIDE 6.8K	5% 3W F
R713	1-247-752-11	CARBON 1K	5% 1/2W
R714	1-215-922-11	METAL OXIDE 6.8K	5% 3W F
R715	1-247-752-11	CARBON 1K	5% 1/2W
R719	1-215-480-00	METAL 300K	1% 1/4W
R720	1-249-923-11	CARBON 1K	5% 1/4W F
R721	1-215-489-00	METAL 680K	1% 1/4W
R722	1-249-923-11	CARBON 1K	5% 1/4W F
R723	1-215-479-00	METAL 270K	1% 1/4W
R724	1-249-923-11	CARBON 1K	5% 1/4W F
R725	1-249-421-11	CARBON 2.2K	5% 1/4W
R726	1-249-421-11	CARBON 2.2K	5% 1/4W
R727	1-249-421-11	CARBON 2.2K	5% 1/4W
R728	1-249-407-11	CARBON 150	5% 1/4W
R729	1-249-407-11	CARBON 150	5% 1/4W
R730	1-249-407-11	CARBON 150	5% 1/4W
R731	1-249-407-11	CARBON 150	5% 1/4W
R732	1-249-407-11	CARBON 150	5% 1/4W
R733	1-249-406-11	CARBON 120	5% 1/4W
R734	1-247-739-11	CARBON 100	5% 1/2W
R738	1-247-807-31	CARBON 100	5% 1/4W
R739	1-247-807-31	CARBON 100	5% 1/4W
R740	1-247-807-31	CARBON 100	5% 1/4W
R755	1-249-418-11	CARBON 1.2K	5% 1/4W
R756	1-249-418-11	CARBON 1.2K	5% 1/4W
R757	1-249-418-11	CARBON 1.2K	5% 1/4W
<<VARIABLE RESISTOR>			
RV702	1-241-656-21	RES, ADJ, METAL FILM 110M	

	* A-1241-355-A	F BOARD, MOUNTED	*****
	1-533-223-11	CLIP, FUSE	
	* 4-374-846-01	COVER, CAPACITOR, CAP TYPE	
<<CAPACITOR>			
C654	1-117-703-11	CERAMIC 0.0047MF	99% 250V
C4602 Δ	1-104-708-91	FILM 0.47MF	20% 250V

REF. NO.	PART NO.	DESCRIPTION	REMARK
<<CONNECTOR>			
CN4601 *	1-580-843-11	PIN, CONNECTOR (POWER)	
CN4602 *	1-580-843-11	PIN, CONNECTOR (POWER)	
CN4603	1-695-915-11	TAB (CONTACT)	
<<FUSE>			
F4601 Δ	1-532-237-11	FUSE, TIME-LAG (BET) 3.15A/250V	
<<RESISTOR>			
R4601 Δ	1-202-719-11	SOLID 1M 10% 1/2W	
<<TRANSFORMER>			
T4601	1-424-682-91	TRANSFORMER, LINE FILTER (EXCEPT KV-PF21P10)	
T4602	1-424-682-91	TRANSFORMER, LINE FILTER (EXCEPT KV-PF21P10)	
T4601 Δ	1-424-682-91	TRANSFORMER, LINE FILTER (KV-PF21P10)	
T4602 Δ	1-424-682-91	TRANSFORMER, LINE FILTER (KV-PF21P10)	
<<VARISTOR>			
VDR461	1-801-073-31	VARISTOR TNR14V471K660	

	* A-1347-155-A	V1 BOARD, COMPLETE (KV-PF21P41 only)	*****
<<CAPACITOR>			
C801	1-104-664-11	ELECT 47MF	20% 16V
C805	1-163-038-91	CERAMIC CHIP 0.1MF	25V
C806	1-163-038-91	CERAMIC CHIP 0.1MF	25V
C815	1-163-251-11	CERAMIC CHIP 100PF	5% 50V
C816	1-164-505-11	CERAMIC CHIP 2.2MF	16V
C817	1-164-004-11	CERAMIC CHIP 0.1MF	10% 25V
C818	1-163-239-11	CERAMIC CHIP 33PF	5% 50V
C820	1-163-239-11	CERAMIC CHIP 33PF	5% 50V
C821	1-163-038-91	CERAMIC CHIP 0.1MF	25V
C822	1-163-009-11	CERAMIC CHIP 0.001MF	10% 50V
C823	1-126-933-11	ELECT 100MF	20% 16V
C826	1-126-963-11	ELECT 4.7MF	20% 50V
C829	1-163-113-00	CERAMIC CHIP 68PF	5% 50V
C830	1-163-038-91	CERAMIC CHIP 0.1MF	25V
C831	1-126-933-11	ELECT 100MF	20% 16V
C832	1-126-964-11	ELECT 10MF	20% 50V
C835	1-163-038-91	CERAMIC CHIP 0.1MF	25V
C837	1-126-933-11	ELECT 100MF	20% 16V



REF. NO.	PART NO.	DESCRIPTION	REMARK	REF. NO.	PART NO.	DESCRIPTION	REMARK
		<<CONNECTOR>					
CN801 *	1-774-812-11	CONNECTOR, BOARD TO BOARD 7P		R805	1-216-295-91	SHORT	0
CN803 *	1-774-812-11	CONNECTOR, BOARD TO BOARD 7P		R807	1-216-295-91	SHORT	0
		<<DIODE>		R813	1-216-295-91	SHORT	0
D802	8-719-914-44	DIODE DAP202K		R820	1-216-073-00	RES,CHIP	10K 5% 1/10W
D803	8-719-105-46	DIODE RD3.3M-B2		R821	1-216-083-00	RES,CHIP	27K 5% 1/10W
D804	8-719-105-91	DIODE RD5.6M-B2					
D806	8-719-988-61	DIODE ISS355TE-17		R822	1-216-025-91	RES,CHIP	100 5% 1/10W
D807	8-719-988-61	DIODE ISS355TE-17		R824	1-216-295-91	SHORT	0
		<<FERRITE BEAD>		R825	1-216-295-91	SHORT	0
FB801	1-410-397-21	FERRITE 1.1UH		R827	1-216-295-91	SHORT	0
FB802	1-410-397-21	FERRITE 1.1UH		R828	1-216-025-91	RES,CHIP	100 5% 1/10W
FB803	1-410-397-21	FERRITE 1.1UH					
FB804	1-410-682-31	INDUCTOR 470UH		R829	1-216-025-91	RES,CHIP	100 5% 1/10W
FB805	1-410-397-21	FERRITE 1.1UH		R830	1-216-295-91	SHORT	0
		<<IC>		R831	1-216-295-91	SHORT	0
IC801	8-759-476-87	IC SAA5261		R832	1-208-790-11	RES,CHIP	2.2K 0.50% 1/10W
		<<CHIP CONDUCTOR>		R835	1-216-295-91	SHORT	0
JR801	1-216-295-91	SHORT 0		R839	1-216-655-11	RES,CHIP	1.5K 0.50% 1/10W
JR802	1-216-295-91	SHORT 0		R841	1-216-025-91	RES,CHIP	100 5% 1/10W
JR804	1-216-295-91	SHORT 0		R842	1-216-065-91	RES,CHIP	4.7K 5% 1/10W
JR805	1-216-295-91	SHORT 0		R843	1-216-065-91	RES,CHIP	4.7K 5% 1/10W
JR806	1-216-295-91	SHORT 0		R844	1-216-057-00	RES,CHIP	2.2K 5% 1/10W
JR807	1-216-295-91	SHORT 0					
JR808	1-216-295-91	SHORT 0		R845	1-216-049-91	RES,CHIP	1K 5% 1/10W
		<<TRANSISTOR>		R846	1-216-049-91	RES,CHIP	1K 5% 1/10W
Q801	8-729-120-28	TRANSISTOR 2SC1623-L5L6		R847	1-216-049-91	RES,CHIP	1K 5% 1/10W
Q803	8-729-120-28	TRANSISTOR 2SC1623-L5L6		R848	1-216-049-91	RES,CHIP	1K 5% 1/10W
Q805	8-729-120-28	TRANSISTOR 2SC1623-L5L6		R849	1-216-049-91	RES,CHIP	1K 5% 1/10W
Q806	8-729-120-28	TRANSISTOR 2SC1623-L5L6					
Q807	8-729-120-28	TRANSISTOR 2SC1623-L5L6		R850	1-216-105-91	RES,CHIP	220K 5% 1/10W
Q808	8-729-120-28	TRANSISTOR 2SC1623-L5L6		R851	1-216-057-00	RES,CHIP	2.2K 5% 1/10W
Q810	8-729-120-28	TRANSISTOR 2SC1623-L5L6		R853	1-216-067-00	RES,CHIP	5.6K 5% 1/10W
Q811	8-729-019-01	TRANSISTOR 2SD2394-EF		R857	1-216-081-00	RES,CHIP	22K 5% 1/10W
Q812	8-729-120-28	TRANSISTOR 2SC1623-L5L6		R858	1-216-067-00	RES,CHIP	5.6K 5% 1/10W
Q813	8-729-120-28	TRANSISTOR 2SC1623-L5L6					
Q814	8-729-120-28	TRANSISTOR 2SC1623-L5L6		R861	1-216-049-91	RES,CHIP	1K 5% 1/10W
Q817	8-729-900-53	TRANSISTOR DTC114EK		R862	1-260-095-11	CARBON	470 5% 1/2W
Q818	8-729-120-28	TRANSISTOR 2SC1623-L5L6		R863	1-216-049-91	RES,CHIP	1K 5% 1/10W
		<<RESISTOR>		R864	1-216-041-00	RES,CHIP	470 5% 1/10W
R800	1-208-806-11	RES,CHIP 10K	0.50% 1/10W	R866	1-215-880-00	METAL OXIDE	10 5% 2W F
R801	1-216-295-91	SHORT 0					
R802	1-216-025-91	RES,CHIP 100	5% 1/10W	R871	1-216-037-00	RES,CHIP	330 5% 1/10W
R803	1-216-295-91	SHORT 0		R879	1-216-073-00	RES,CHIP	10K 5% 1/10W
R804	1-216-295-91	SHORT 0		R880	1-216-041-00	RES,CHIP	470 5% 1/10W
		<<CRYSTAL>		R882	1-216-049-91	RES,CHIP	1K 5% 1/10W
				R884	1-216-025-91	RES,CHIP	100 5% 1/10W
				R888	1-216-065-91	RES,CHIP	4.7K 5% 1/10W
				R889	1-216-073-00	RES,CHIP	10K 5% 1/10W
				R890	1-216-081-00	RES,CHIP	22K 5% 1/10W
				R894	1-216-073-00	RES,CHIP	10K 5% 1/10W
				R895	1-216-065-91	RES,CHIP	4.7K 5% 1/10W
				R896	1-216-073-00	RES,CHIP	10K 5% 1/10W
				R897	1-216-073-00	RES,CHIP	10K 5% 1/10W
				R898	1-216-065-91	RES,CHIP	4.7K 5% 1/10W
				X801	1-578-774-11	VIBRATOR, CRYSTAL	

The components identified by shading and mark Δ are critical for safety. Replace only with part number specified.

REF. NO.	PART NO.	DESCRIPTION	REMARK
		MISCELLANEOUS *****	
	1-416-946-21	COIL, DEMAGNETIC	
	1-417-151-21	MATCHING TRANSFORMER, ANTENNA (Except KV-PF21P41)	
	1-452-032-00	MAGNET,DISC	
	1-452-094-00	CIRCULAR DISC MAGNET B	
	1-501-372-81	ANTENNA, TELESCOPIC (Except KV-PF21L70/PF21P41)	
	1-569-008-21	ADAPTOR, CONVERSION 2P (KV-PF21L70/PF21M70(ME)/PF21Q70 only)	
	1-505-740-11	SPEAKER (5X9CM)	
	Δ 1-574-062-11	CORD, POWER (WITH CONNECTOR) 2.5A/250V (Exept KV-PF21P10)	
	Δ 1-574-358-11	CORD, POWER (WITH CONNECTOR) 7.5A/250V (KV-PF21P10)	
	8-451-505-11	DEFLECTION YOKE (Y21RSA-S) (Exept KV-PF21P10)	
	Δ 8-451-505-11	DEFLECTION YOKE (Y21RSA-S)(KV-PF21P10)	
	8-738-812-05	PICTURE TUBE (A51LPT70X) (KV-PF21M40/PF21P40/PF21P41)	
	8-738-809-05	PICTURE TUBE (A51LPT70X) (KV-PF21L70/PF21M70/PF21P10/PF21Q70)	

REF. NO.	PART NO.	DESCRIPTION	REMARK
		ACCESSORIES AND PACKING MATERIALS *****	
	1-417-151-21	MATCHING TRANSFORMER, ANTENNA (Except KV-PF21P41)	
	1-501-372-81	ANTENNA, TELESCOPIC (Except KV-PF21L70/PF21P41)	
	1-569-008-21	ADAPTOR, CONVERSION 2P (KV-PF21L70/M70(ME)/PF21Q70 only)	
	3-701-910-00	SCREW, SPECIAL (DIA 3.8X20)	
	3-867-184-21	MANUAL,INSTRUCTION (KV-PF21M40/PF21P40/PF21P41)	
	3-867-184-31	MANUAL,INSTRUCTION (KV-PF21L70(ME)/PF21Q70)/M70(ME))	
	3-867-184-61	MANUAL,INSTRUCTION (KV-PF21M70(E))	
	3-867-184-41	MANUAL,INSTRUCTION (KV-PF21P10)	
	* 4-070-297-01	CUSHION(UPPER)(ASSY)	
	* 4-070-298-01	CUSHION(LOWER)(ASSY)	
	3-867-184-12	MANUAL, INSTRUCTION (KV-PF21M40/GE)	
	* 4-070-299-01	INDIVIDUAL CARTON	
	4-392-003-11	BAND, HOLD	
	4-392-004-11	CLIP	
	* 4-392-859-01	BAG, PROTECTION	
		REMOTE COMMANDER *****	
	1-418-163-11	REMOTE COMMANDER (RM-952)	
	9-933-895-01	BATTERY COVER, REMOTE COMMANDER	

