

Tantalum Surface Mount Capacitors

Space Grade



One world. One KEMET.

Electronic Components
KEMET
CHARGED.®

Table of Contents	Page
Why Choose KEMET	3
T493 Series COTS Space Grade	5
T496 Series Fail-Safe Fused Space Grade	18
T497 Series High Grade COTS Space Grade	30
T510 Series Multiple Anode Low ESR Space Grade	43
Packaging Information.....	53
KEMET Corporation Sales Offices	58
Disclaimer	59

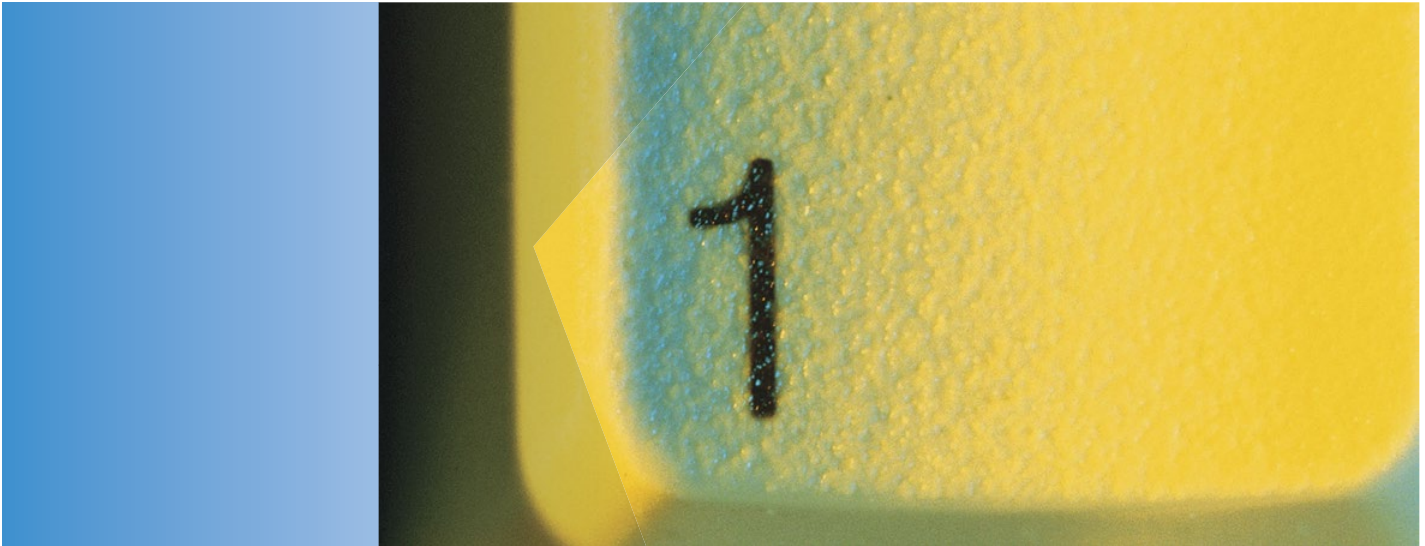

One world. One source. One KEMET.

When you partner with KEMET, our entire global organization provides you with the coordinated service you need. No bouncing from supplier to supplier. No endless phone calls and web browsing. We're your single, integrated source for electronic component solutions worldwide.

Less hassles. More solutions.

Our commitment to product quality and on-time delivery has helped customers succeed for over 90 years. There's a reason KEMET components can be found in defense and aerospace equipment. Our reputation is built on a history of consistency, reliability and service.

The "Easy-to-Buy-From" company.

KEMET offers a level of responsiveness that far surpasses any other supplier. Our passion for customer service is evident throughout our global sales organization, which offers localized support bolstered by our worldwide logistics capabilities. Whether you need rush samples, technical assistance, in-person consultation, accelerated custom design, design collaboration or prototype services, we have a solution.



Made for you.

When you need custom products delivered on a tight schedule, you can trust KEMET. Get direct design consultation from global experts, who help you get the job done on time and within budget.

Working for a better world.

KEMET is dedicated to economically, environmentally and socially sustainable development. We've adopted the Electronic Industry Code of Conduct (EICC) to address all aspects of corporate responsibility. Our manufacturing facilities have won numerous environmental excellence awards and recognitions, and our supply chain is certified. We believe doing the right thing is in everyone's interest.

About KEMET.

KEMET Corporation is a leading global supplier of electronic components. We offer our customers the broadest selection of capacitor technologies in the industry across multiple dielectrics, along with an expanding range of electromechanical devices, and electromagnetic compatibility solutions. Our vision is to be the preferred supplier of electronic component solutions for customers demanding the highest standards of quality, delivery and service.

Overview

KEMET's Space Grade Series of capacitors are suitable for use by defense/aerospace customers in high reliability space applications. This series meets the requirements of MIL-PRF-55365 as well as MIL-STD-1580. These capacitors incorporate an intensive testing and screening protocol which is customizable depending upon customer's specific needs. The full part number allows for designation of Weibull grading level

(B=0.1%/k hours or C=0.01%/k hours), surge current level (10 cycles -55°C and +85°C before and/or after Weibull grading), performance testing level (see chart for details on available options), ESR (low and standard), and termination finish (see description in each series). Fused versions are available for built-in circuit protection, as well as multi-anode designs for very low ESR values.

Benefits

- Standard case sizes A-X per EIA 535BAAC
- Termination finishes options per MIL-PRF-55365: Gold Plated B, Hot Solder Dipped C, Solder Plated H, Solder Fused K
- Weibull Grading C (0.01%/1,000 hours)
- Surge current testing available per MIL-PRF-55365: 10 cycles @ 25°C, 10 cycles @ -55°C and +85°C
- Standard and low ESR options available
- Operating temperature range of -55°C to +125°C
- Capacitance values of 0.1 µF to 330 µF
- Voltage rating of 4 – 50 VDC

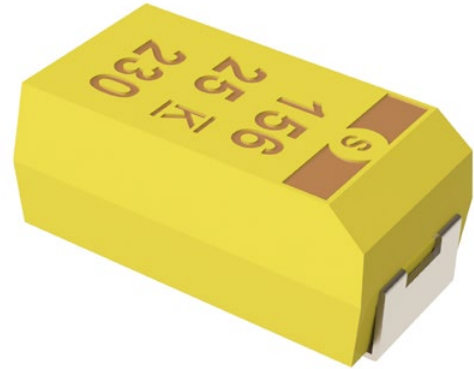

Applications

Typical applications include decoupling and filtering in defense and aerospace applications.

Environmental Compliance

RoHS Compliant (6/6) according to Directive 2002/95/EC when ordered with 100% Sn solder.



RoHS Compliant

SPICE

For a detailed analysis of specific part numbers, please visit www.kemet.com for a free download of KEMET's SPICE software. The KEMET SPICE program is freeware intended to aid design engineers in analyzing the performance of these capacitors over frequency, temperature, ripple, and DC bias conditions.

Ordering Information

T	493	D	227	K	006	C	H	61	2	A
Capacitor Class	Series	Case Size	Capacitance Code (pF)	Capacitance Tolerance	Voltage	Failure Rate/Design	Lead Material	Surge	ESR	Testing
T = Tantalum	CRW11 Style Space Grade	A, B, C, D, X	First two digits represent significant figures. Third digit specifies number of zeros.	J = ±5% K = ±10% M = ±20%	004 = 4 V 006 = 6.3 V 010 = 10 V 016 = 16 V 020 = 20 V 025 = 25 V 035 = 35 V 050 = 50 V	C = .01%/1,000 hours	C = Hot Solder Dipped H = Standard Solder Coated (SnPb 5% Pb minimum) B = Gold Plated K = Solder Fused T = 100% Tin	61 = None 62 = 10 Cycles after Weibull, 25°C 63 = 10 Cycles, after Weibull, -55°C and 85°C 64 = 10 Cycles before Weibull, -55°C and 85°C 65 = 10 Cycles Before and After Weibull, -55°C and 85°C	1 = ESR - Standard 2 = ESR - Low	A = Option A B = Option B C = Option C

Performance Characteristics

Item	Performance Characteristics
Operating Temperature	-55°C to 125°C
Rated Capacitance Range	0.1 – 330 µF @ 120 Hz/25°C
Capacitance Tolerance	J Tolerance (5%), K Tolerance (10%), M Tolerance (20%)
Rated Voltage Range	4 – 50 V
DF (120 Hz)	Refer to Part Number Electrical Specification Table
ESR (100 kHz)	Refer to Part Number Electrical Specification Table
Leakage Current	≤ 0.01 CV (mA) at rated voltage after 5 minutes

Qualification

Test	Condition	Characteristics				
Endurance	85°C @ rated voltage, 2,000 hours 125°C @ 2/3 rated voltage, 2,000 hours	Δ C/C	Within ±10% of initial value			
		DF	Within initial limits			
		DCL	Within 1.25 x initial limit			
		ESR	Within initial limits			
Storage Life	125°C @ 0 volts, 2,000 hours	Δ C/C	Within ±10% of initial value			
		DF	Within initial limits			
		DCL	Within 1.25 x initial limit			
		ESR	Within initial limits			
Thermal Shock	MIL-STD-202, Method 107, Condition B, mounted, -55°C to 125°C, 1,000 cycles	Δ C/C	Within ±5% of initial value			
		DF	Within initial limits			
		DCL	Within 1.25 x initial limit			
		ESR	Within initial limits			
Temperature Stability	Extreme temperature exposure at a succession of continuous steps at +25°C, -55°C, +25°C, +85°C, +125°C, +25°C		+25°C	-55°C	+85°C	+125°C
		Δ C/C	IL*	±10%	±10%	±20%
		DF	IL	IL	1.5 x IL	1.5 x IL
		DCL	IL	n/a	10 x IL	12 x IL
Surge Voltage	25°C and 85°C, 1.32 x rated voltage 1,000 cycles. (125°C, 1.2 x rated voltage)	Δ C/C	Within ±5% of initial value			
		DF	Within initial limits			
		DCL	Within initial limits			
		ESR	Within initial limits			
Mechanical Shock/Vibration	MIL-STD-202, Method 213, Condition I, 100 G peak. MIL-STD-202, Method 204, Condition D, 10 Hz to 2,000 Hz, 20 G peak	Δ C/C	Within ±10% of initial value			
		DF	Within initial limits			
		DCL	Within initial limits			

*IL = Initial Limit

Certification

MIL-PRF-55365/8
 DSCC Drawing 07016

Test Methods

Test Sequence	Test Method	Option A	Option B	Option C
100% Serialization	KEMET Standard			X
100% IR Reflow	MIL-PRF-55365	X	X	X
100% Thermal Shock	MIL-PRF-55365	X	X	X
100% Electrical Verification	KEMET Standard	X		X
Read and Record Attributes/Variables Data	KEMET Standard			X
100% Surge Current, Option C with 5% PDA Calculation	MIL-PRF-55365 with 5% PDA Calculation	X	X	X
100% Electrical Verification	KEMET Standard		X	X
Read and Record Attributes/Variables Data	KEMET Standard			X
100% Voltage Aging, 10 hours @1.32 Vr	MIL-PRF-55365		X	X
100% Electrical Verification	KEMET Standard		X	X
100% Weibull Grading B or C	MIL-PRF-55365	X	X	X
100% Electrical Verification	KEMET Standard	X	X	X
Read and Record Attributes/Variables Data	KEMET Standard			X
100% Surge Current, Option A or B with 5% PDA Calculation	MIL-PRF-55365 with 5% PDA Calculation	X	X	X
100% Electrical Verification	KEMET Standard	X	X	X
Read and Record Attributes/Variables Data	KEMET Standard			X
3 Sigma Screening - All Electricals	KEMET Standard	X	X	X
Read and Record Attributes/Variables Data	KEMET Standard			X
Destructive Physical Analysis (DPA) (5 pieces- each lot)	MIL-PRF-55365	X	X	X
Group B Testing (22 pieces - each lot)	* See Note Below		X	X
Temperature Stability - sample	MIL-PRF-55365	X	X	X
Solderability - Sample	MIL-PRF-55365	X	X	X
Group C Testing (57 pieces - each Lot)**	MIL-PRF-55365		X	X
100% X-ray	MIL-PRF-55365	X		
100% X-ray - 2 Plane***	MIL-PRF-55365 and KEMET Standard		X	X
100% Physical Dimension Verification	MIL-PRF-55365	X	X	X
Data Pack				
Group A and C Summaries			X	X
2 Plane X-ray JPEG photos			X	X
DPA Report			X	X
Attributes/Variables Data for Cap/Df/DCL/ESR				X

X = Included in test option

* Group B Testing = 10,000 Cycles Surge Current, 85°C, 40% Vr

** Group C Post Moisture ESR limit = 1.25 initial limit

*** 2 Plane X-ray = Top and side views, molded case wall thickness minimum 0.005" on all sides, negative/positive termination attachment criteria per MIL-STD-1580

Electrical Characteristics

ESR vs. Frequency

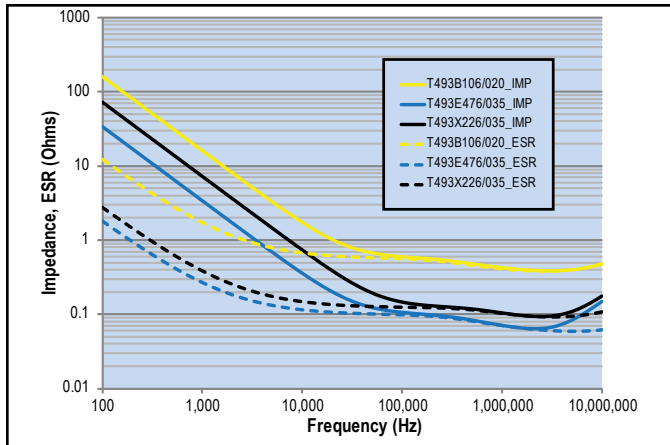

Capacitance vs. Frequency

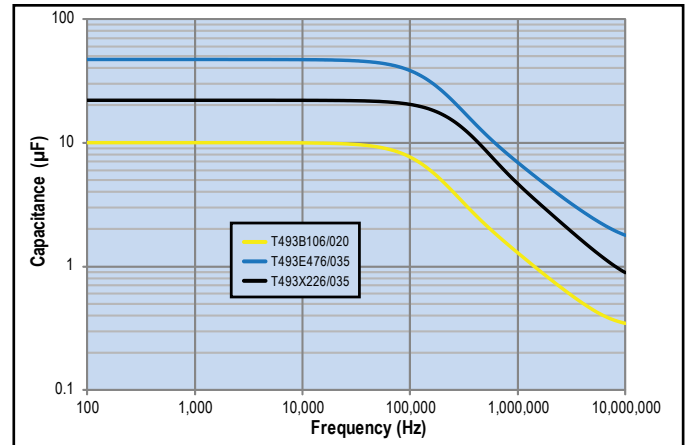

Dimensions – Millimeters (Inches)

Metric will govern

CATHODE (-) END VIEW

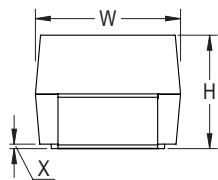

SIDE VIEW

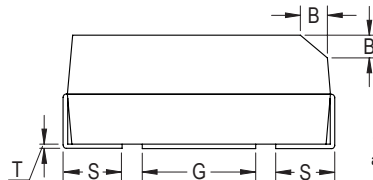

ANODE (+) END VIEW

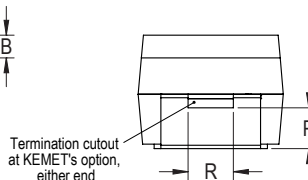

BOTTOM VIEW

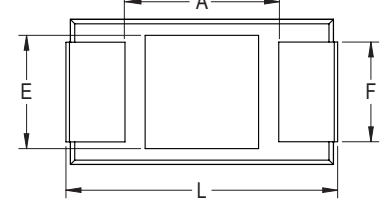

Case Size		Component												
KEMET	EIA	L*	W*	H*	F* ±0.1 ±(.004)	S* ±0.3 ±(.012)	B* ±0.15 (Ref) ±.006	X (Ref)	P (Ref)	R (Ref)	T (Ref)	A (Min)	G (Ref)	E (Ref)
A	3216-18	3.2 ±0.2 (0.126 ±0.008)	1.6 ±0.2 (0.063 ±0.008)	1.6 ±0.2 (0.063 ±0.008)	1.2 (.047)	0.8 (.031)	0.4 (.016)	0.10 ± 0.10 (.004 ± .004)	0.4 (.016)	0.4 (.016)	0.13 (.005)	0.8 (.031)	1.1 (.043)	1.3 (.051)
B	3528-21	3.5 ±0.2 (0.138 ±0.008)	2.8 ±0.2 (0.110 ±0.008)	1.9 ±0.2 (0.075 ±0.008)	2.2 (.087)	0.8 (.031)	0.4 (.016)	0.10 ± 0.10 (.004 ± .004)	0.5 (.020)	1.0 (.039)	0.13 (.005)	1.1 (.043)	1.8 (.071)	2.2 (.087)
C	6032-28	6.0 ±0.3 (0.236 ±0.03)	3.2 ±0.3 (0.126 ±0.012)	2.5 ±0.3 (0.098 ±0.012)	2.2 (.087)	1.3 (.051)	0.5 (.020)	0.10 ± 0.10 (.004 ± .004)	0.9 (.035)	1.0 (.039)	0.13 (.005)	2.5 (.098)	2.8 (.110)	2.4 (.094)
D	7343-31	7.3 ±0.3 (0.287 ±0.012)	4.3 ±0.3 (0.169 ±0.012)	2.8 ±0.3 (0.110 ±0.012)	2.4 (.094)	1.3 (.051)	0.5 (.020)	0.10 ± 0.10 (.004 ± .004)	0.9 (.035)	1.0 (.039)	0.13 (.005)	3.8 (.150)	3.5 (.138)	3.5 (.138)
X	7343-43	7.3 ±0.3 (0.287 ±0.012)	4.3 ±0.3 (0.169 ±0.012)	4.0 ±0.3 (0.157 ±0.012)	2.4 (.094)	1.3 (.051)	0.5 (.020)	0.10 ± 0.10 (.004 ± .004)	1.7 (.067)	1.0 (.039)	0.13 (.005)	3.8 (.150)	3.5 (.138)	3.5 (.138)

Notes: (Ref) – Dimensions provided for reference only. No dimensions provided for B, P or R because low profile cases do not have a bevel or a notch.

* MIL-C-55365/8 specified dimensions

Table 1 – Ratings & Part Number Reference

Rated Voltage	Rated Capacitance	Case Code/ Case Size	KEMET Part Number	DC Leakage	DF	Standard ESR	Low ESR	Moisture Sensitivity
V	µF	KEMET/EIA	(See below for part options)	µA @ +20°C Maximum/5 Min	% @ +20°C 120 Hz Maximum	Ω @ +20°C 100 kHz Maximum	Ω @ +20°C 100 kHz Maximum	Temperature ≤ 260°C
4	2.2	A/3216-18	T493A225(1)004(2)(3)(4)(5)(6)	0.5	6.0	8.0	6.0	1
4	3.3	A/3216-18	T493A335(1)004(2)(3)(4)(5)(6)	0.5	6.0	8.0	4.0	1
4	4.7	A/3216-18	T493A475(1)004(2)(3)(4)(5)(6)	0.5	6.0	8.0	3.5	1
4	6.8	A/3216-18	T493A685(1)004(2)(3)(4)(5)(6)	0.5	6.0	6.0	3.0	1
4	6.8	B/3528-21	T493B685(1)004(2)(3)(4)(5)(6)	0.5	6.0	5.5	2.0	1
4	10.0	A/3216-18	T493A106(1)004(2)(3)(4)(5)(6)	0.5	6.0	6.0	2.0	1
4	10.0	B/3528-21	T493B106(1)004(2)(3)(4)(5)(6)	0.5	6.0	3.5	1.2	1
4	15.0	A/3216-18	T493A156(1)004(2)(3)(4)(5)(6)	0.6	6.0	4.0	1.5	1
4	15.0	B/3528-21	T493B156(1)004(2)(3)(4)(5)(6)	0.6	6.0	3.5	1.2	1
4	22.0	A/3216-18	T493A226(1)004(2)(3)(4)(5)(6)	0.9	6.0	4.0	1.5	1
4	22.0	B/3528-21	T493B226(1)004(2)(3)(4)(5)(6)	0.9	6.0	3.5	0.6	1
4	22.0	C/6032-28	T493C226(1)004(2)(3)(4)(5)(6)	0.9	6.0	1.8	0.5	1
4	33.0	B/3528-21	T493B336(1)004(2)(3)(4)(5)(6)	1.3	6.0	3.5	0.5	1
4	33.0	C/6032-28	T493C336(1)004(2)(3)(4)(5)(6)	1.3	6.0	1.8	0.5	1
4	47.0	B/3528-21	T493B476(1)004(2)(3)(4)(5)(6)	1.9	6.0	3.0	0.5	1
4	47.0	C/6032-28	T493C476(1)004(2)(3)(4)(5)(6)	1.9	6.0	1.8	0.5	1
4	68.0	B/3528-21	T493B686(1)004(2)(3)(4)(5)(6)	2.7	6.0	3.5	2.0	1
4	68.0	C/6032-28	T493C686(1)004(2)(3)(4)(5)(6)	2.7	6.0	1.6	0.25	1
4	68.0	D/7343-31	T493D686(1)004(2)(3)(4)(5)(6)	2.7	6.0	0.8	0.2	1
4	100.0	C/6032-28	T493C107(1)004(2)(3)(4)(5)(6)	4.0	8.0	1.2	0.2	1
4	100.0	D/7343-31	T493D107(1)004(2)(3)(4)(5)(6)	4.0	8.0	0.8	0.2	1
4	150	C/6032-28	T493C157(1)004(2)(3)(4)(5)(6)	6	8	1.2	0.3	1
4	150	D/7343-31	T493D157(1)004(2)(3)(4)(5)(6)	6	8	0.8	0.15	1
4	220	D/7343-31	T493D227(1)004(2)(3)(4)(5)(6)	8.8	8	0.9	0.7	1
4	330	D/7343-31	T493D337(1)004(2)(3)(4)(5)(6)	13.2	8	0.7	0.15	1
4	330	X/7343-43	T493X337(1)004(2)(3)(4)(5)(6)	13.2	8	0.5	0.2	1
6.3	1.5	A/3216-18	T493A155(1)006(2)(3)(4)(5)(6)	0.5	6	8	6	1
6.3	2.2	A/3216-18	T493A225(1)006(2)(3)(4)(5)(6)	0.5	6	8	6	1
6.3	3.3	A/3216-18	T493A335(1)006(2)(3)(4)(5)(6)	0.5	6	8	6	1
6.3	4.7	A/3216-18	T493A475(1)006(2)(3)(4)(5)(6)	0.5	6	6	3.5	1
6.3	4.7	B/3528-21	T493B475(1)006(2)(3)(4)(5)(6)	0.5	6	5.5	3.5	1
6.3	6.8	A/3216-18	T493A685(1)006(2)(3)(4)(5)(6)	0.5	6	6	2	1
6.3	6.8	B/3528-21	T493B685(1)006(2)(3)(4)(5)(6)	0.5	6	3.5	1.2	1
6.3	10	A/3216-18	T493A106(1)006(2)(3)(4)(5)(6)	0.6	6	4	2	1
6.3	10	B/3528-21	T493B106(1)006(2)(3)(4)(5)(6)	0.6	6	3.5	1	1
6.3	15	A/3216-18	T493A156(1)006(2)(3)(4)(5)(6)	0.9	6	4	1.5	1
6.3	15	B/3528-21	T493B156(1)006(2)(3)(4)(5)(6)	0.9	6	3.5	0.7	1
6.3	15	C/6032-28	T493C156(1)006(2)(3)(4)(5)(6)	0.9	6	1.8	0.6	1
6.3	22	B/3528-21	T493B226(1)006(2)(3)(4)(5)(6)	1.4	6	3.5	0.6	1
6.3	22	C/6032-28	T493C226(1)006(2)(3)(4)(5)(6)	1.4	6	1.8	0.5	1
6.3	33	B/3528-21	T493B336(1)006(2)(3)(4)(5)(6)	2	6	3	0.6	1
6.3	33	C/6032-28	T493C336(1)006(2)(3)(4)(5)(6)	2	6	1.8	0.3	1
6.3	47	B/3528-21	T493B476(1)006(2)(3)(4)(5)(6)	2.9	6	3.5	2	1
6.3	47	C/6032-28	T493C476(1)006(2)(3)(4)(5)(6)	2.9	6	1.6	0.25	1
6.3	47	D/7343-31	T493D476(1)006(2)(3)(4)(5)(6)	2.9	6	0.8	0.22	1
6.3	68	C/6032-28	T493C686(1)006(2)(3)(4)(5)(6)	4.1	6	1.2	0.2	1
6.3	68	D/7343-31	T493D686(1)006(2)(3)(4)(5)(6)	4.1	6	0.8	0.2	1
V	µF	KEMET/EIA	(See below for part options)	µA @ +20°C Maximum/5 Min	% @ +20°C 120 Hz Maximum	Ω @ +20°C 100 kHz Maximum	Ω @ +20°C 100 kHz Maximum	Temperature ≤ 260°C
Rated Voltage	Rated Capacitance	Case Code/ Case Size	KEMET Part Number	DC Leakage	DF	Standard ESR	Low ESR	Moisture Sensitivity

(1) To complete KEMET part number, insert M for ±20%, K for ±10%. Designates Capacitance tolerance.
 (2) To complete KEMET part number, insert C (0.01%/1,000 hours). Designates Reliability Level.
 (3) To complete KEMET part number, insert H = Solder Plated or T = 100% Tin (Sn). Designates Termination Finish.
 (4) To complete KEMET part number, insert 61 = None, 62 = 10 cycles +25°C, 63 = 10 cycles -55°C +85°C after Weibull, 64 = 10 cycles -55°C +85°C before Weibull or 65 = Both. Designates Surge current option.
 (5) To complete KEMET part number, insert 1 = Standard ESR, 2 = Low ESR. Designates ESR option.
 (6) To complete KEMET part number, insert A = Option 1, B = Option 2 or C = Option 3. Designates Test Option. See Space Grade Test Methods chart for more information.
 Refer to Ordering Information for additional detail.

Table 1 – Ratings & Part Number Reference cont'd

Rated Voltage	Rated Capacitance	Case Code/ Case Size	KEMET Part Number	DC Leakage	DF	Standard ESR	Low ESR	Moisture Sensitivity
V	µF	KEMET/EIA	(See below for part options)	µA @ +20°C Maximum/5 Min	% @ +20°C 120 Hz Maximum	Ω @ +20°C 100 kHz Maximum	Ω @ +20°C 100 kHz Maximum	Temperature ≤ 260°C
6.3	100	C/6032-28	T493C107(1)006(2)(3)(4)(5)(6)	6	8	1.2	0.3	1
6.3	100	D/7343-31	T493D107(1)006(2)(3)(4)(5)(6)	6	8	0.8	0.15	1
6.3	150	D/7343-31	T493D157(1)006(2)(3)(4)(5)(6)	9	8	0.7	0.15	1
6.3	220	D/7343-31	T493D227(1)006(2)(3)(4)(5)(6)	13.2	8	0.7	0.1	1
6.3	220	X/7343-43	T493X227(1)006(2)(3)(4)(5)(6)	13.2	8	0.7	0.15	1
6.3	330	D/7343-31	T493D337(1)006(2)(3)(4)(5)(6)	19.8	8	0.5	0.15	1
6.3	330	X/7343-43	T493X337(1)006(2)(3)(4)(5)(6)	19.8	8	0.5	0.1	1
10	1	A/3216-18	T493A105(1)010(2)(3)(4)(5)(6)	0.5	4	10	6	1
10	1.5	A/3216-18	T493A155(1)010(2)(3)(4)(5)(6)	0.5	6	8	6	1
10	2.2	A/3216-18	T493A225(1)010(2)(3)(4)(5)(6)	0.5	6	8	6	1
10	3.3	A/3216-18	T493A335(1)010(2)(3)(4)(5)(6)	0.5	6	6	4	1
10	3.3	B/3528-21	T493B335(1)010(2)(3)(4)(5)(6)	0.5	6	5.5	3.5	1
10	4.7	A/3216-18	T493A475(1)010(2)(3)(4)(5)(6)	0.5	6	6	3	1
10	4.7	B/3528-21	T493B475(1)010(2)(3)(4)(5)(6)	0.5	6	3.5	1.5	1
10	6.8	A/3216-18	T493A685(1)010(2)(3)(4)(5)(6)	0.7	6	6	3	1
10	6.8	B/3528-21	T493B685(1)010(2)(3)(4)(5)(6)	0.7	6	3.5	1.2	1
10	10	A/3216-18	T493A106(1)010(2)(3)(4)(5)(6)	1	6	4	1.8	1
10	10	B/3528-21	T493B106(1)010(2)(3)(4)(5)(6)	1	6	3.5	0.8	1
10	10	C/6032-28	T493C106(1)010(2)(3)(4)(5)(6)	1	6	1.8	0.6	1
10	15	B/3528-21	T493B156(1)010(2)(3)(4)(5)(6)	1.5	6	3.5	0.7	1
10	15	C/6032-28	T493C156(1)010(2)(3)(4)(5)(6)	1.5	6	1.8	0.5	1
10	22	B/3528-21	T493B226(1)010(2)(3)(4)(5)(6)	2.2	6	3	0.7	1
10	22	C/6032-28	T493C226(1)010(2)(3)(4)(5)(6)	2.2	6	1.8	0.4	1
10	33	C/6032-28	T493C336(1)010(2)(3)(4)(5)(6)	3.3	6	1.6	0.3	1
10	33	D/7343-31	T493D336(1)010(2)(3)(4)(5)(6)	3.3	6	0.8	0.25	1
10	47	C/6032-28	T493C476(1)010(2)(3)(4)(5)(6)	4.7	6	1.2	0.3	1
10	47	D/7343-31	T493D476(1)010(2)(3)(4)(5)(6)	4.7	6	0.8	0.22	1
10	68	C/6032-28	T493C686(1)010(2)(3)(4)(5)(6)	6.8	6	1.2	0.3	1
10	68	D/7343-31	T493D686(1)010(2)(3)(4)(5)(6)	6.8	6	0.8	0.2	1
10	68	X/7343-43	T493X686(1)010(2)(3)(4)(5)(6)	5.4	4	0.5	0.15	1
10	100	D/7343-31	T493D107(1)010(2)(3)(4)(5)(6)	10	8	0.7	0.1	1
10	150	D/7343-31	T493D157(1)010(2)(3)(4)(5)(6)	15	8	0.7	0.1	1
10	150	X/7343-43	T493X157(1)010(2)(3)(4)(5)(6)	15	8	0.7	0.15	1
10	220	D/7343-31	T493D227(1)010(2)(3)(4)(5)(6)	22	8	0.5	0.15	1
10	220	X/7343-43	T493X227(1)010(2)(3)(4)(5)(6)	22	8	0.5	0.1	1
10	330	X/7343-43	T493X337(1)010(2)(3)(4)(5)(6)	33	10	0.5	0.1	1
16	0.68	A/3216-18	T493A684(1)016(2)(3)(4)(5)(6)	1.1	6	12	8	1
16	1	A/3216-18	T493A105(1)016(2)(3)(4)(5)(6)	0.5	4	10	6	1
16	1.5	A/3216-18	T493A155(1)016(2)(3)(4)(5)(6)	0.5	6	8	6	1
16	2.2	A/3216-18	T493A225(1)016(2)(3)(4)(5)(6)	0.5	6	6	4	1
16	3.3	B/3528-21	T493B335(1)016(2)(3)(4)(5)(6)	0.5	6	3.5	2	1
16	4.7	B/3528-21	T493B475(1)016(2)(3)(4)(5)(6)	0.8	6	3.5	1.5	1
16	6.8	B/3528-21	T493B685(1)016(2)(3)(4)(5)(6)	1.1	6	3.5	1.2	1
16	6.8	C/6032-28	T493C685(1)016(2)(3)(4)(5)(6)	1.1	6	1.9	0.8	1
16	10	C/6032-28	T493C106(1)016(2)(3)(4)(5)(6)	1.6	6	1.8	0.6	1
16	15	C/6032-28	T493C156(1)016(2)(3)(4)(5)(6)	2.4	6	1.8	0.4	1
16	22	C/6032-28	T493C226(1)016(2)(3)(4)(5)(6)	3.6	6	1.6	0.35	1
V	µF	KEMET/EIA	(See below for part options)	µA @ +20°C Maximum/5 Min	% @ +20°C 120 Hz Maximum	Ω @ +20°C 100 kHz Maximum	Ω @ +20°C 100 kHz Maximum	Temperature ≤ 260°C
Rated Voltage	Rated Capacitance	Case Code/ Case Size	KEMET Part Number	DC Leakage	DF	Standard ESR	Low ESR	Moisture Sensitivity

(1) To complete KEMET part number, insert M for ±20%, K for ±10%. Designates Capacitance tolerance.
 (2) To complete KEMET part number, insert C (0.01%/1,000 hours). Designates Reliability Level.
 (3) To complete KEMET part number, insert H = Solder Plated or T = 100% Tin (Sn). Designates Termination Finish.
 (4) To complete KEMET part number, insert 61 = None, 62 = 10 cycles +25°C, 63 = 10 cycles -55°C +85°C after Weibull, 64 = 10 cycles -55°C +85°C before Weibull or 65 = Both. Designates Surge current option.
 (5) To complete KEMET part number, insert 1 = Standard ESR, 2 = Low ESR. Designates ESR option.
 (6) To complete KEMET part number, insert A = Option 1, B = Option 2 or C = Option 3. Designates Test Option. See Space Grade Test Methods chart for more information.
 Refer to Ordering Information for additional detail.

Table 1 – Ratings & Part Number Reference cont'd

Rated Voltage	Rated Capacitance	Case Code/ Case Size	KEMET Part Number	DC Leakage	DF	Standard ESR	Low ESR	Moisture Sensitivity
V	µF	KEMET/EIA	(See below for part options)	µA @ +20°C Maximum/5 Min	% @ +20°C 120 Hz Maximum	Ω @ +20°C 100 kHz Maximum	Ω @ +20°C 100 kHz Maximum	Temperature ≤ 260°C
16	22	D/7343-31	T493D226(1)016(2)(3)(4)(5)(6)	3.6	6	0.8	0.25	1
16	33	D/7343-31	T493D336(1)016(2)(3)(4)(5)(6)	5.3	6	0.8	0.25	1
16	47	D/7343-31	T493D476(1)016(2)(3)(4)(5)(6)	7.5	6	0.8	0.2	1
16	68	D/7343-31	T493D686(1)016(2)(3)(4)(5)(6)	10.9	6	0.7	0.15	1
16	100	X/7343-43	T493X107(1)016(2)(3)(4)(5)(6)	16	8	0.7	0.1	1
20	0.47	A/3216-18	T493A474(1)020(2)(3)(4)(5)(6)	0.5	4	14	9	1
20	0.68	A/3216-18	T493A684(1)020(2)(3)(4)(5)(6)	0.5	4	12	8	1
20	1	A/3216-18	T493A105(1)020(2)(3)(4)(5)(6)	0.5	4	10	5.5	1
20	1.5	B/3528-21	T493B155(1)020(2)(3)(4)(5)(6)	0.5	6	6	4.0	1
20	2.2	B/3528-21	T493B225(1)020(2)(3)(4)(5)(6)	0.5	6	3.5	1.5	1
20	3.3	B/3528-21	T493B335(1)020(2)(3)(4)(5)(6)	0.7	6	3.5	1.3	1
20	4.7	C/6032-28	T493C475(1)020(2)(3)(4)(5)(6)	1	6	2.4	0.6	1
20	6.8	C/6032-28	T493C685(1)020(2)(3)(4)(5)(6)	1.4	6	1.9	0.6	1
20	10	C/6032-28	T493C106(1)020(2)(3)(4)(5)(6)	2	6	1.8	0.5	1
20	15	C/6032-28	T493C156(1)020(2)(3)(4)(5)(6)	3	6	1.7	0.4	1
20	15	D/7343-31	T493D156(1)020(2)(3)(4)(5)(6)	3	6	1	0.35	1
20	22	D/7343-31	T493D226(1)020(2)(3)(4)(5)(6)	4.4	6	0.8	0.3	1
20	33	D/7343-31	T493D336(1)020(2)(3)(4)(5)(6)	6.6	6	0.8	0.2	1
20	47	X/7343-43	T493X476(1)020(2)(3)(4)(5)(6)	7.5	4	0.7	0.15	1
20	68	X/7343-43	T493X686(1)020(2)(3)(4)(5)(6)	13.6	6	0.7	0.15	1
25	0.33	A/3216-18	T493A334(1)025(2)(3)(4)(5)(6)	0.5	4	15	10	1
25	0.47	A/3216-18	T493A474(1)025(2)(3)(4)(5)(6)	0.5	4	14	9	1
25	0.68	A/3216-18	T493A684(1)025(2)(3)(4)(5)(6)	0.5	4	10	6	1
25	0.68	B/3528-21	T493B684(1)025(2)(3)(4)(5)(6)	0.5	4	7.5	5.5	1
25	1	A/3216-18	T493A105(1)025(2)(3)(4)(5)(6)	0.5	4	8	4	1
25	1	B/3528-21	T493B105(1)025(2)(3)(4)(5)(6)	0.5	4	5	2	1
25	1.5	A/3216-18	T493A155(1)025(2)(3)(4)(5)(6)	0.5	6	10	3	1
25	1.5	B/3528-21	T493B155(1)025(2)(3)(4)(5)(6)	0.5	6	5	1.5	1
25	2.2	B/3528-21	T493B225(1)025(2)(3)(4)(5)(6)	0.6	6	4.5	1.2	1
25	2.2	C/6032-28	T493C225(1)025(2)(3)(4)(5)(6)	0.6	6	3.5	2.2	1
25	3.3	B/3528-21	T493B335(1)025(2)(3)(4)(5)(6)	0.9	6	3.5	2	1
25	3.3	C/6032-28	T493C335(1)025(2)(3)(4)(5)(6)	0.9	6	2.5	1.2	1
25	4.7	C/6032-28	T493C475(1)025(2)(3)(4)(5)(6)	1.2	6	2.4	0.6	1
25	6.8	C/6032-28	T493C685(1)025(2)(3)(4)(5)(6)	1.7	6	1.9	0.6	1
25	6.8	D/7343-31	T493D685(1)025(2)(3)(4)(5)(6)	1.7	6	1.4	1	1
25	10	C/6032-28	T493C106(1)025(2)(3)(4)(5)(6)	2.5	6	1.5	0.5	1
25	10	D/7343-31	T493D106(1)025(2)(3)(4)(5)(6)	2.5	6	1	0.4	1
25	15	C/6032-28	T493C156(1)025(2)(3)(4)(5)(6)	3.8	6	1.5	0.9	1
25	15	D/7343-31	T493D156(1)025(2)(3)(4)(5)(6)	3.8	6	1	0.35	1
25	15	X/7343-43	T493X156(1)025(2)(3)(4)(5)(6)	3	6	0.7	0.2	1
25	22	D/7343-31	T493D226(1)025(2)(3)(4)(5)(6)	5.5	6	0.8	0.2	1
25	22	X/7343-43	T493X226(1)025(2)(3)(4)(5)(6)	4.4	4	0.7	0.23	1
25	33	X/7343-43	T493X336(1)025(2)(3)(4)(5)(6)	8.3	6	0.7	0.3	1
35	0.10	A/3216-18	T493A104(1)035(2)(3)(4)(5)(6)	0.5	4	20	10	1
35	0.15	A/3216-18	T493A154(1)035(2)(3)(4)(5)(6)	0.5	4	19	6	1
35	0.22	A/3216-18	T493A224(1)035(2)(3)(4)(5)(6)	0.5	4	18	6	1
35	0.33	A/3216-18	T493A334(1)035(2)(3)(4)(5)(6)	0.5	4	15	6	1
V	µF	KEMET/EIA	(See below for part options)	µA @ +20°C Maximum/5 Min	% @ +20°C 120 Hz Maximum	Ω @ +20°C 100 kHz Maximum	Ω @ +20°C 100 kHz Maximum	Temperature ≤ 260°C
Rated Voltage	Rated Capacitance	Case Code/ Case Size	KEMET Part Number	DC Leakage	DF	Standard ESR	Low ESR	Moisture Sensitivity

(1) To complete KEMET part number, insert M for ±20%, K for ±10%. Designates Capacitance tolerance.
 (2) To complete KEMET part number, insert C (0.01%/1,000 hours). Designates Reliability Level.
 (3) To complete KEMET part number, insert H = Solder Plated or T = 100% Tin (Sn). Designates Termination Finish.
 (4) To complete KEMET part number, insert 61 = None, 62 = 10 cycles +25°C, 63 = 10 cycles -55°C +85°C after Weibull, 64 = 10 cycles -55°C +85°C before Weibull or 65 = Both. Designates Surge current option.
 (5) To complete KEMET part number, insert 1 = Standard ESR, 2 = Low ESR. Designates ESR option.
 (6) To complete KEMET part number, insert A = Option 1, B = Option 2 or C = Option 3. Designates Test Option. See Space Grade Test Methods chart for more information.
 Refer to Ordering Information for additional detail.

Table 1 – Ratings & Part Number Reference cont'd

Rated Voltage	Rated Capacitance	Case Code/ Case Size	KEMET Part Number	DC Leakage	DF	Standard ESR	Low ESR	Moisture Sensitivity
V	µF	KEMET/EIA	(See below for part options)	µA @ +20°C Maximum/5 Min	% @ +20°C 120 Hz Maximum	Ω @ +20°C 100 kHz Maximum	Ω @ +20°C 100 kHz Maximum	Temperature ≤ 260°C
35	0.47	A/3216-18	T493A474(1)035(2)(3)(4)(5)(6)	0.5	4	14	4	1
35	0.47	B/3528-21	T493B474(1)035(2)(3)(4)(5)(6)	0.5	4	8	2.5	1
35	0.68	A/3216-18	T493A684(1)035(2)(3)(4)(5)(6)	0.5	4	10	6	1
35	0.68	B/3528-21	T493B684(1)035(2)(3)(4)(5)(6)	0.5	4	6.5	2.5	1
35	1.0	B/3528-21	T493B105(1)035(2)(3)(4)(5)(6)	0.5	4	5	2	1
35	1.5	B/3528-21	T493B155(1)035(2)(3)(4)(5)(6)	0.5	6	5	3	1
35	1.5	C/6032-28	T493C155(1)035(2)(3)(4)(5)(6)	0.5	6	4.5	2.5	1
35	2.2	B/3528-21	T493B225(1)035(2)(3)(4)(5)(6)	0.8	6	4	2.5	1
35	2.2	C/6032-28	T493C225(1)035(2)(3)(4)(5)(6)	0.8	6	3.5	1.5	1
35	3.3	C/6032-28	T493C335(1)035(2)(3)(4)(5)(6)	1.2	6	2.5	0.8	1
35	4.7	C/6032-28	T493C475(1)035(2)(3)(4)(5)(6)	1.7	6	2.5	0.6	1
35	4.7	D/7343-31	T493D475(1)035(2)(3)(4)(5)(6)	1.7	6	1.5	0.7	1
35	6.8	D/7343-31	T493D685(1)035(2)(3)(4)(5)(6)	2.4	6	1.3	0.5	1
35	10	D/7343-31	T493D106(1)035(2)(3)(4)(5)(6)	3.5	6	1	0.3	1
35	10	X/7343-43	T493X106(1)035(2)(3)(4)(5)(6)	2.8	4	0.9	0.25	1
35	15	D/7343-31	T493D156(1)035(2)(3)(4)(5)(6)	5.3	6	0.8	0.3	1
35	15	X/7343-43	T493X156(1)035(2)(3)(4)(5)(6)	5.3	6	0.9	0.3	1
35	22	X/7343-43	T493X226(1)035(2)(3)(4)(5)(6)	7.7	6	0.7	0.3	1
50	0.10	A/3216-18	T493A104(1)050(2)(3)(4)(5)(6)	0.5	4	20	10	1
50	0.15	A/3216-18	T493A154(1)050(2)(3)(4)(5)(6)	0.5	4	19	10	1
50	0.15	B/3528-21	T493B154(1)050(2)(3)(4)(5)(6)	0.5	4	16	10	1
50	0.22	B/3528-21	T493B224(1)050(2)(3)(4)(5)(6)	0.5	4	14	10	1
50	0.33	B/3528-21	T493B334(1)050(2)(3)(4)(5)(6)	0.5	4	10	2.5	1
50	0.47	B/3528-21	T493B474(1)050(2)(3)(4)(5)(6)	0.5	4	9	2	1
50	0.47	C/6032-28	T493C474(1)050(2)(3)(4)(5)(6)	0.5	4	8	1.8	1
50	0.68	C/6032-28	T493C684(1)050(2)(3)(4)(5)(6)	0.5	4	7	1.6	1
50	1	C/6032-28	T493C105(1)050(2)(3)(4)(5)(6)	0.5	4	5.5	1.6	1
50	1.5	C/6032-28	T493C155(1)050(2)(3)(4)(5)(6)	0.8	6	4.5	1.5	1
50	1.5	D/7343-31	T493D155(1)050(2)(3)(4)(5)(6)	0.8	6	3.5	1	1
50	2.2	C/6032-28	T493C225(1)050(2)(3)(4)(5)(6)	1.1	6	3.5	1.5	1
50	2.2	D/7343-31	T493D225(1)050(2)(3)(4)(5)(6)	1.1	6	2.5	0.8	1
50	3.3	D/7343-31	T493D335(1)050(2)(3)(4)(5)(6)	1.7	6	2	0.8	1
50	4.7	D/7343-31	T493D475(1)050(2)(3)(4)(5)(6)	2.4	6	1.5	0.6	1
50	4.7	X/7343-43	T493X475(1)050(2)(3)(4)(5)(6)	1.9	4	0.9	0.3	1
50	6.8	X/7343-43	T493X685(1)050(2)(3)(4)(5)(6)	3.5	6	1	0.5	1
50	10	X/7343-43	T493X106(1)050(2)(3)(4)(5)(6)	5	6	0.7	0.4	1
V	µF	KEMET/EIA	(See below for part options)	µA @ +20°C Maximum/5 Min	% @ +20°C 120 Hz Maximum	Ω @ +20°C 100 kHz Maximum	Ω @ +20°C 100 kHz Maximum	Temperature ≤ 260°C
Rated Voltage	Rated Capacitance	Case Code/ Case Size	KEMET Part Number	DC Leakage	DF	Standard ESR	Low ESR	Moisture Sensitivity

- (1) To complete KEMET part number, insert M for ±20%, K for ±10%. Designates Capacitance tolerance.
 - (2) To complete KEMET part number, insert C (0.01%/1,000 hours). Designates Reliability Level.
 - (3) To complete KEMET part number, insert H = Solder Plated or T = 100% Tin (Sn). Designates Termination Finish.
 - (4) To complete KEMET part number, insert 61 = None, 62 = 10 cycles +25°C, 63 = 10 cycles -55°C +85°C after Weibull, 64 = 10 cycles -55°C +85°C before Weibull or 65 = Both. Designates Surge current option.
 - (5) To complete KEMET part number, insert 1 = Standard ESR, 2 = Low ESR. Designates ESR option.
 - (6) To complete KEMET part number, insert A = Option 1, B = Option 2 or C = Option 3. Designates Test Option. See Space Grade Test Methods chart for more information.
- Refer to Ordering Information for additional detail.

Recommended Voltage Derating Guidelines

	-55°C to 85°C	85°C to 125°C
% Change in Working DC Voltage with Temperature	V_R	67% of V_R
Recommended Maximum Application Voltage	50% of V_R	33% of V_R

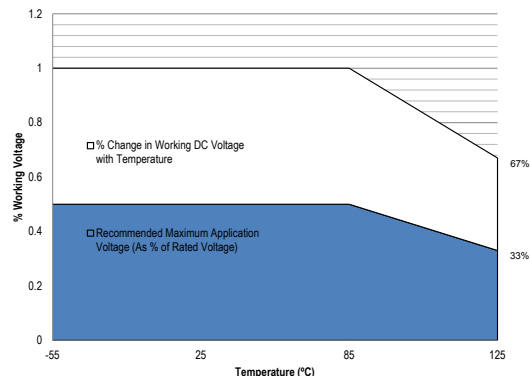

Ripple Current/Ripple Voltage

Permissible AC ripple voltage and current are related to equivalent series resistance (ESR) and the power dissipation capabilities of the device. Permissible AC ripple voltage which may be applied is limited by two criteria:

1. The positive peak AC voltage plus the DC bias voltage, if any, must not exceed the DC voltage rating of the capacitor.
2. The negative peak AC voltage in combination with bias voltage, if any, must not exceed the allowable limits specified for reverse voltage. See the Reverse Voltage section for allowable limits.

The maximum power dissipation by case size can be determined using the table at right. The maximum power dissipation rating stated in the table must be reduced with increasing environmental operating temperatures. Refer to the table below for temperature compensation requirements.

KEMET Case Code	EIA Case Code	Maximum Power Dissipation (P max) mWatts @ 25°C w/+20°C Rise
A	3216-18	75
B	3528-21	85
C	6032-28	110
D	7343-31	150
X	7343-43	165

The maximum power dissipation rating must be reduced with increasing environmental operating temperatures. Refer to the Temperature Compensation Multiplier table for details.

Temperature Compensation Multipliers for Maximum Ripple Current		
T ≤ 25°C	T ≤ 85°C	T ≤ 125°C
1.00	0.90	0.40

T = Environmental Temperature

Using the P max of the device, the maximum allowable rms ripple current or voltage may be determined.

$$I(max) = \sqrt{P_{max}/R}$$

$$E(max) = Z \sqrt{P_{max}/R}$$

I = rms ripple current (amperes)

R = ESR at specified frequency (ohms)

E = rms ripple voltage (volts)

Z = Impedance at specified frequency (ohms)

P max = maximum power dissipation (watts)

Reverse Voltage

Solid tantalum capacitors are polar devices and may be permanently damaged or destroyed if connected with the wrong polarity. The positive terminal is identified on the capacitor body by a stripe plus in some cases a beveled edge. A small degree of transient reverse voltage is permissible for short periods per the table. The capacitors should not be operated continuously in reverse mode, even within these limits.

Temperature	Permissible Transient Reverse Voltage
25°C	15% of Rated voltage
85°C	5% of Rated voltage
125°C	1% of Rated voltage

Table 2 – Land Dimensions/Courtyard

KEMET	Metric Size Code	Density Level A: Maximum (Most) Land Protrusion (mm)					Density Level B: Median (Nominal) Land Protrusion (mm)					Density Level C: Minimum (Least) Land Protrusion (mm)					
		Case	EIA	W	L	S	V1	V2	W	L	S	V1	V2	W	L	S	V1
A	3216-18		1.35	2.20	0.62	6.02	2.80	1.23	1.80	0.82	4.92	2.30	1.13	1.42	0.98	4.06	2.04
B	3528-21		2.35	2.21	0.92	6.32	4.00	2.23	1.80	1.12	5.22	3.50	2.13	1.42	1.28	4.36	3.24
C	6032-28		2.35	2.77	2.37	8.92	4.50	2.23	2.37	2.57	7.82	4.00	2.13	1.99	2.73	6.96	3.74
D	7343-31		2.55	2.77	3.67	10.22	5.60	2.43	2.37	3.87	9.12	5.10	2.33	1.99	4.03	8.26	4.84
X ¹	7343-43		2.55	2.77	3.67	10.22	5.60	2.43	2.37	3.87	9.12	5.10	2.33	1.99	4.03	8.26	4.84

Density Level A: For low-density product applications. Recommended for wave solder applications and provides a wider process window for reflow solder processes.

Density Level B: For products with a moderate level of component density. Provides a robust solder attachment condition for reflow solder processes.

Density Level C: For high component density product applications. Before adapting the minimum land pattern variations the user should perform qualification testing based on the conditions outlined in IPC Standard 7351 (IPC-7351).

¹ Height of these chips may create problems in wave soldering.

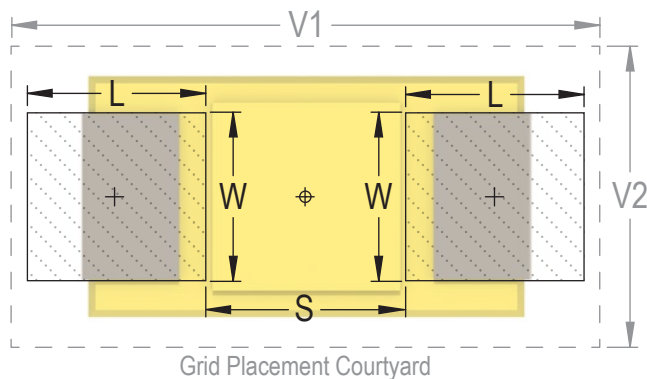

Soldering Process

KEMET’s families of surface mount capacitors are compatible with wave (single or dual), convection, IR, or vapor phase reflow techniques. Preheating of these components is recommended to avoid extreme thermal stress. KEMET’s recommended profile conditions for convection and IR reflow reflect the profile conditions of the IPC/J–STD–020D standard for moisture sensitivity testing. The devices can safely withstand a maximum of three reflow passes at these conditions.

Please note that although the X/7343–43 case size can withstand wave soldering, the tall profile (4.3 mm maximum) dictates care in wave process development.

Hand soldering should be performed with care due to the difficulty in process control. If performed, care should be taken to avoid contact of the soldering iron to the molded case. The iron should be used to heat the solder pad, applying solder between the pad and the termination, until reflow occurs. Once reflow occurs, the iron should be removed immediately. “Wiping” the edges of a chip and heating the top surface is not recommended.

During typical reflow operations, a slight darkening of the gold-colored epoxy may be observed. This slight darkening is normal and not harmful to the product. Marking permanency is not affected by this change.

Profile Feature	SnPb Assembly	Pb-Free Assembly
Preheat/Soak		
Temperature Minimum (T_{smin})	100°C	150°C
Temperature Maximum (T_{smax})	150°C	200°C
Time (t_s) from T_{smin} to T_{smax}	60 – 120 seconds	60 – 120 seconds
Ramp-up Rate (T_L to T_P)	3°C/seconds maximum	3°C/seconds maximum
Liquidous Temperature (T_L)	183°C	217°C
Time Above Liquidous (t_L)	60 – 150 seconds	60 – 150 seconds
Peak Temperature (T_P)	220°C* 235°C**	250°C* 260°C**
Time within 5°C of Maximum Peak Temperature (t_p)	20 seconds maximum	30 seconds maximum
Ramp-down Rate (T_P to T_L)	6°C/seconds maximum	6°C/seconds maximum
Time 25°C to Peak Temperature	6 minutes maximum	8 minutes maximum

Note: All temperatures refer to the center of the package, measured on the package body surface that is facing up during assembly reflow.

*Case Size D, E, P, Y, and X

**Case Size A, B, C, H, I, K, M, R, S, T, U, V, W, and Z

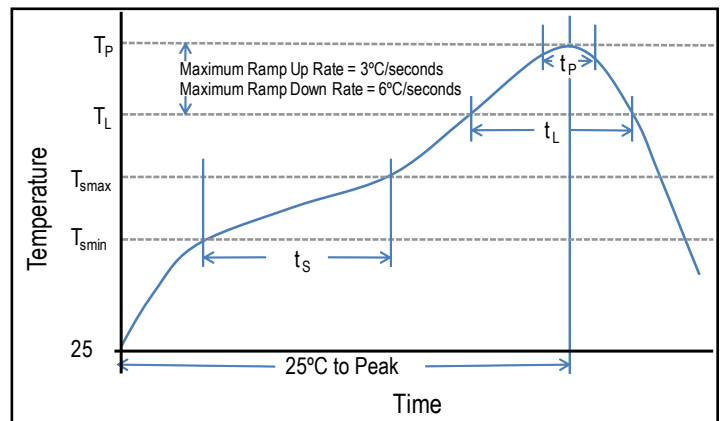

Storage

Tantalum chip capacitors should be stored in normal working environments. While the chips themselves are quite robust in other environments, solderability will be degraded by exposure to high temperatures, high humidity, corrosive atmospheres, and long term storage. In addition, packaging materials will be degraded by high temperature– reels may soften or warp and tape peel force may increase. KEMET recommends that maximum storage temperature not exceed 40°C and maximum storage humidity not exceed 60% relative humidity. Temperature fluctuations should be minimized to avoid condensation on the parts and atmospheres should be free of chlorine and sulphur bearing compounds. For optimized solderability chip stock should be used promptly, preferably within three years of receipt.

Construction

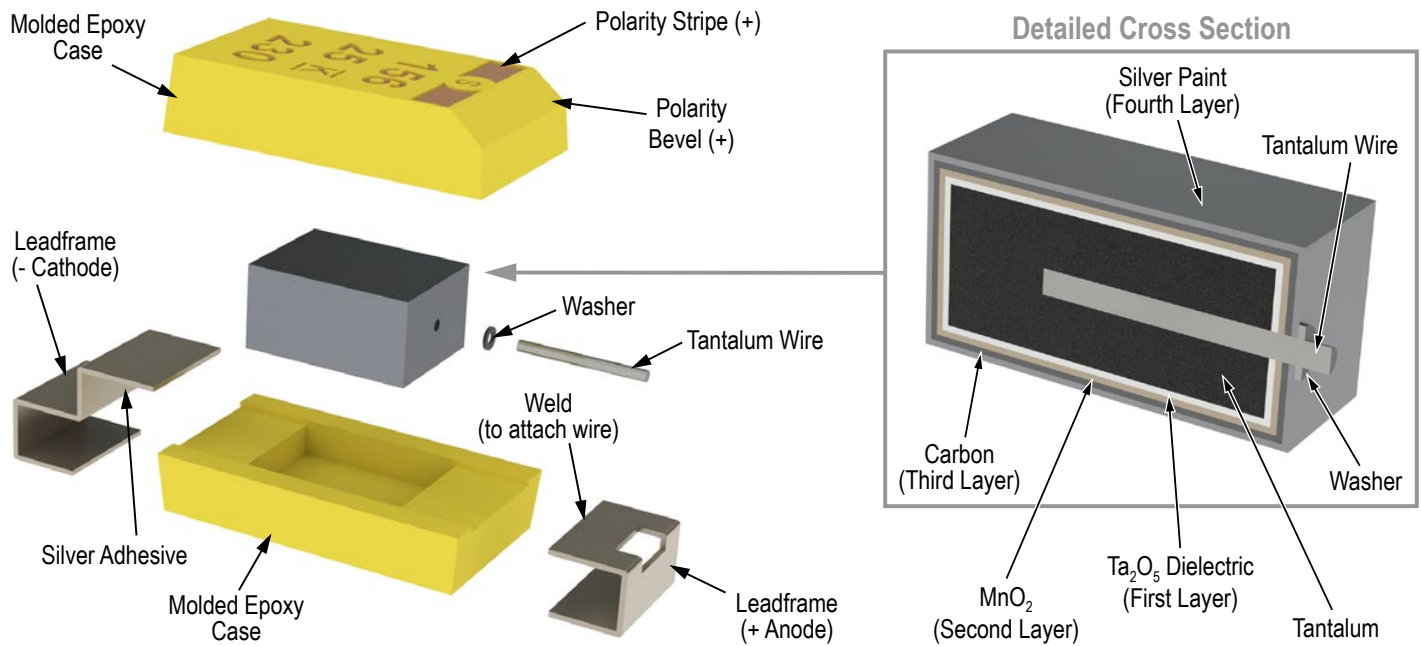

Capacitor Marking

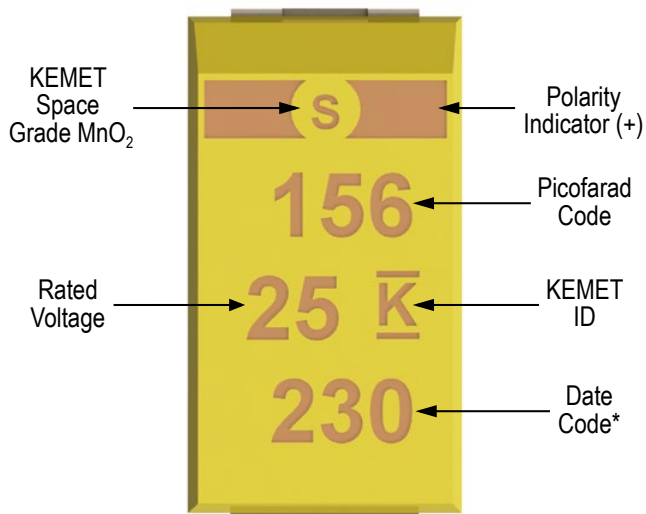

* 230 = 30th week of 2012

Date Code *	
1 st digit = Last number of Year	9 = 2009 0 = 2010 1 = 2011 2 = 2012 3 = 2013 4 = 2014
2 nd and 3 rd digit = Week of the Year	01 = 1 st week of the Year to 52 = 52 nd week of the Year

Overview

KEMET's Space Grade Series of capacitors are suitable for use by defense/aerospace customers in high reliability space applications. This series meets the requirements of MIL-PRF-55365 as well as MIL-STD-1580. These capacitors incorporate an intensive testing and screening protocol which is customizable depending upon customer's specific needs. The full part number allows for designation of Weibull grading level

(B=0.1%/k hours or C=0.01%/k hours), surge current level (10 cycles -55°C and +85°C before and/or after Weibull grading), performance testing level (see chart for details on available options), ESR (low and standard), and termination finish (see description in each series). Fused versions are available for built-in circuit protection, as well as multi-anode designs for very low ESR values

Benefits

- Internal fuse protects against damaging short circuit failure mode
- Standard case sizes B, C, D, X per EIA 535BAAC
- 100% surge current test available
- Optional gold-plated terminations
- Operating temperature range of -55°C to +125°C
- Fuse activation, 25°C: within 1 second at fault currents of 4 amps and higher
- Continuous current capability: 0.75 amps
- Post actuation resistance, 25°C: 10 MΩ, minimum
- Test tabs on side of case bypass the capacitor element to allow direct testing of the fuse assembly
- RoHS Compliant and lead-free terminations
- Weibull Grading C (0.01%/1,000 hours)
- Capacitance values of 0.15 μF to 470 μF
- Voltage rating of 4 – 50 VDC

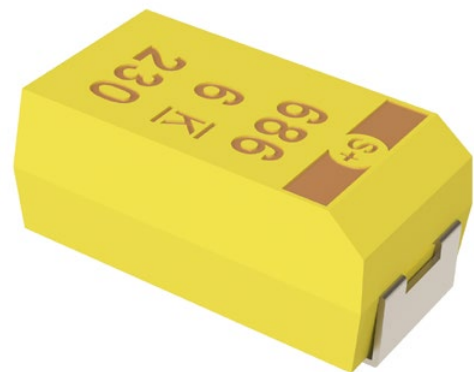

Environmental Compliance

RoHS Compliant (6/6) according to Directive 2002/95/EC when ordered with 100% Sn solder.



RoHS Compliant

SPICE

For a detailed analysis of specific part numbers, please visit www.kemet.com for a free download of KEMET's SPICE software. The KEMET SPICE program is freeware intended to aid design engineers in analyzing the performance of these capacitors over frequency, temperature, ripple, and DC bias conditions.

Ordering Information

T	496	X	227	M	010	C	T	61	2	A
Capacitor Class	Series	Case Size	Capacitance Code (pF)	Capacitance Tolerance	Voltage	Failure Rate/Design	Lead Material	Surge	ESR	Testing
T = Tantalum	Fail Safe - Space Grade	B, C, D, X	First two digits represent significant figures. Third digit specifies number of zeros.	K = ±10% M = ±20%	004 = 4 V 006 = 6.3 V 010 = 10 V 016 = 16 V 020 = 20 V 025 = 25 V 035 = 35 V 050 = 50 V	C = 0.01%/1,000 hours	C = Hot Solder Dipped T = 100% Matte Tin (Sn) Plated H = Standard Solder Coated (SnPb 5% Pb minimum)	61 = None 62 = 10 Cycles after Weibull, 25°C 63 = 10 Cycles, after Weibull, -55°C and 85°C 64 = 10 Cycles before Weibull, -55°C and 85°C 65 = 10 Cycles Before and After Weibull, -55°C and 85°C	1 = ESR - Standard 2 = ESR - Low	A = Option A B = Option B C = Option C

Performance Characteristics

Item	Performance Characteristics
Operating Temperature	-55°C to 125°C
Rated Capacitance Range	0.15 – 470 µF @ 120 Hz/25°C
Capacitance Tolerance	K Tolerance (10%), M Tolerance (20%)
Rated Voltage Range	4 – 50 V
DF (120 Hz)	Refer to Part Number Electrical Specification Table
ESR (100 kHz)	Refer to Part Number Electrical Specification Table
Leakage Current	≤ 0.01 CV (µA) at rated voltage after 5 minutes

Qualification

Test	Condition	Characteristics				
Endurance	85°C @ rated voltage, 2,000 hours 125°C @ 2/3 rated voltage, 2,000 hours	Δ C/C	Within ±10% of initial value			
		DF	Within initial limits			
		DCL	Within 1.25 x initial limit			
		ESR	Within initial limits			
Storage Life	125°C @ 0 Volts, 2,000 hours	Δ C/C	Within ±10% of initial value			
		DF	Within initial limits			
		DCL	Within 1.25 x initial limit			
		ESR	Within initial limits			
Thermal Shock	MIL-STD-202, Method 107, Condition B, mounted, -55°C to 125°C, 1,000 cycles	Δ C/C	Within ±5% of initial value			
		DF	Within initial limits			
		DCL	Within 1.25 x initial limit			
		ESR	Within initial limits			
Temperature Stability	Extreme temperature exposure at a succession of continuous steps at +25°C, -55°C, +25°C, +85°C, +125°C, +25°C	+25°C	-55°C	+85°C	+125°C	
		Δ C/C	IL*	±10%	±10%	±20%
		DF	IL	IL	1.5 x IL	1.5 x IL
Surge Voltage	25°C and 85°C, 1.32 x rated voltage 1,000 cycles. (125°C, 1.2 x rated voltage)	DCL	IL			
		ESR	n/a			
			10 x IL			
Mechanical Shock/Vibration	MIL-STD-202, Method 213, Condition I, 100 G peak. MIL-STD-202, Method 204, Condition D, 10 Hz to 2,000 Hz, 20 G peak	Δ C/C	Within ±10% of initial value			
		DF	Within initial limits			
		DCL	Within initial limits			

*IL = Initial Limit

Certification

DSCC Drawing 04053

Test Methods

Test Sequence	Test Method	Option A	Option B	Option C
100% Serialization	KEMET Standard			X
100% IR Reflow	MIL-PRF-55365	X	X	X
100% Thermal Shock	MIL-PRF-55365	X	X	X
100% Electrical Verification	KEMET Standard	X		X
Read and Record Attributes/Variables Data	KEMET Standard			X
100% Surge Current, Option C with 5% PDA Calculation	MIL-PRF-55365 with 5% PDA Calculation	X	X	X
100% Electrical Verification	KEMET Standard		X	X
Read and Record Attributes/Variables Data	KEMET Standard			X
100% Voltage Aging, 10 hours @1.32 Vr	MIL-PRF-55365		X	X
100% Electrical Verification	KEMET Standard		X	X
100% Weibull Grading B or C	MIL-PRF-55365	X	X	X
100% Electrical Verification	KEMET Standard	X	X	X
Read and Record Attributes/Variables Data	KEMET Standard			X
100% Surge Current, Option A or B with 5% PDA Calculation	MIL-PRF-55365 with 5% PDA Calculation	X	X	X
100% Electrical Verification	KEMET Standard	X	X	X
Read and Record Attributes/Variables Data	KEMET Standard			X
3 Sigma Screening - All Electricals	KEMET Standard	X	X	X
Read and Record Attributes/Variables Data	KEMET Standard			X
Destructive Physical Analysis (DPA) (5 pieces- each lot)	MIL-PRF-55365	X	X	X
Group B Testing (22 pieces - each lot)	* See Note Below		X	X
Temperature Stability - sample	MIL-PRF-55365	X	X	X
Solderability - Sample	MIL-PRF-55365	X	X	X
Group C Testing (57 pieces - each Lot)**	MIL-PRF-55365		X	X
100% X-ray	MIL-PRF-55365	X		
100% X-ray - 2 Plane***	MIL-PRF-55365 and KEMET Standard		X	X
100% Physical Dimension Verification	MIL-PRF-55365	X	X	X
Data Pack				
Group A and C Summaries			X	X
2 Plane X-ray JPEG photos			X	X
DPA Report			X	X
Attributes/Variables Data for Cap/Df/DCL/ESR				X

X = Included in test option

* Group B Testing = 10,000 Cycles Surge Current, 85°C, 40% Vr

** Group C Post Moisture ESR limit = 1.25 initial limit

*** 2 Plane X-ray = Top and side views, molded case wall thickness minimum 0.005" on all sides, negative/positive termination attachment criteria per MIL-STD-1580

Electrical Characteristics

ESR vs. Frequency

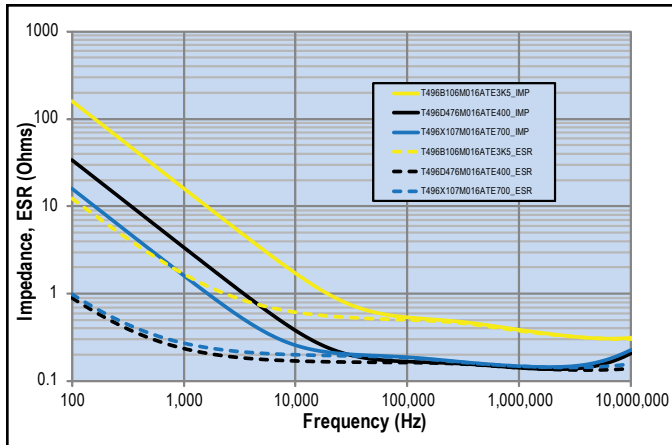

Capacitance vs. Frequency

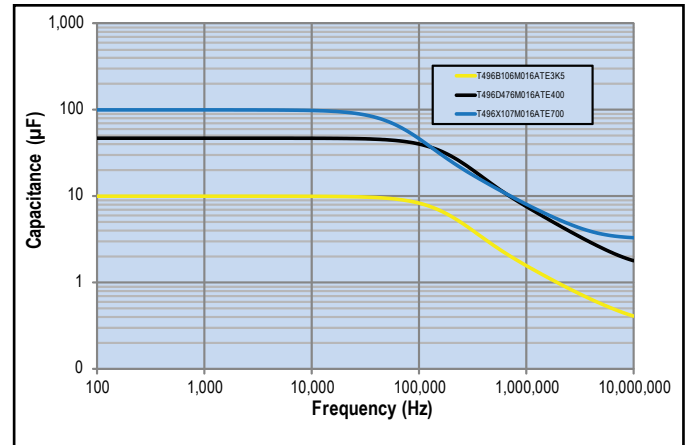

Dimensions – Millimeters (Inches)

Metric will govern

CATHODE (-) END VIEW

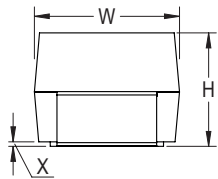

SIDE VIEW



ANODE (+) END VIEW

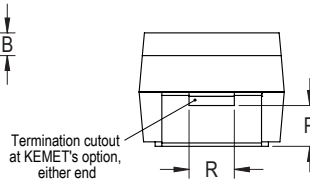

BOTTOM VIEW

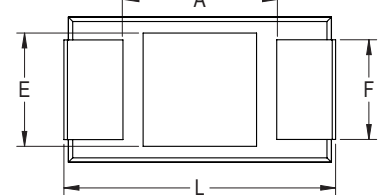

Case Size		Component												
KEMET	EIA	L*	W*	H*	F* ±0.1 ±(.004)	S* ±0.3 ±(.012)	B* ±0.15 (Ref) ±.006	X (Ref)	P (Ref)	R (Ref)	T (Ref)	A (Min)	G (Ref)	E (Ref)
B	3528-21	3.5 ±0.2 (0.138 ±0.008)	2.8 ±0.2 (0.110 ±0.008)	1.9 ±0.2 (0.075 ±0.008)	2.2 (.087)	0.8 (.031)	0.4 (.016)	0.10 ±0.10 (0.004 ±0.004)	0.5 (0.020)	1.0 (0.039)	0.13 (0.005)	1.1 (.043)	1.8 (0.071)	2.2 (0.087)
C	6032-28	6.0 ±0.3 (0.236 ±0.03)	3.2 ±0.3 (0.126 ±0.012)	2.5 ±0.3 (0.098 ±0.012)	2.2 (.087)	1.3 (.051)	0.5 (.020)	0.10 ±0.10 (0.004 ±0.004)	0.9 (0.035)	1.0 (0.039)	0.13 (0.005)	2.5 (.098)	2.8 (0.110)	2.4 (0.094)
D	7343-31	7.3 ±0.3 (0.287 ±0.012)	4.3 ±0.3 (0.169 ±0.012)	2.8 ±0.3 (0.110 ±0.012)	2.4 (.094)	1.3 (.051)	0.5 (.020)	0.10 ±0.10 (0.004 ±0.004)	0.9 (0.035)	1.0 (0.039)	0.13 (0.005)	3.8 (0.150)	3.5 (0.138)	3.5 (0.138)
X	7343-43	7.3 ±0.3 (0.287 ±0.012)	4.3 ±0.3 (0.169 ±0.012)	4.0 ±0.3 (0.157 ±0.012)	2.4 (.094)	1.3 (.051)	0.5 (.020)	0.10 ±0.10 (0.004 ±0.004)	1.7 (0.067)	1.0 (0.039)	0.13 (0.005)	3.8 (0.150)	3.5 (0.138)	3.5 (0.138)

Notes: (Ref) – Dimensions provided for reference only. No dimensions provided for B, P or R because low profile cases do not have a bevel or a notch.

* MIL-C-55365/8 specified dimensions

Table 1 – Ratings & Part Number Reference

Rated Voltage	Rated Capacitance	Case Code/ Case Size	KEMET Part Number	DC Leakage	DF	Standard ESR	Low ESR	Moisture Sensitivity
V	µF	KEMET/EIA	(See below for part options)	µA @ +20°C Maximum/5 Min	% @ +20°C 120 Hz Maximum	Ω @ +20°C 100 kHz Maximum	Ω @ +20°C 100 kHz Maximum	Temperature ≤ 260°C
4	68	C/6032-28	T496C686(1)004(2)(3)(4)(5)(6)	2.7	6	1.6	0.4	1
4	100	C/6032-28	T496C107(1)004(2)(3)(4)(5)(6)	4	8	1.2	N/A	1
4	150	C/6032-28	T496C157(1)004(2)(3)(4)(5)(6)	6	8	1.2	N/A	1
4	150	D/7343-31	T496D157(1)004(2)(3)(4)(5)(6)	6	8	0.8	N/A	1
4	220	D/7343-31	T496D227(1)004(2)(3)(4)(5)(6)	8.8	8	0.7	0.4	1
4	330	D/7343-31	T496D337(1)004(2)(3)(4)(5)(6)	13.2	8	0.7	0.4	1
4	330	X/7343-43	T496X337(1)004(2)(3)(4)(5)(6)	13.2	8	0.7	N/A	1
4	470	X/7343-43	T496X477(1)004(2)(3)(4)(5)(6)	18.8	8	0.5	N/A	1
6.3	4.7	B/3528-21	T496B475(1)006(2)(3)(4)(5)(6)	0.5	6	3.5	N/A	1
6.3	6.8	B/3528-21	T496B685(1)006(2)(3)(4)(5)(6)	0.5	6	3.5	N/A	1
6.3	10	B/3528-21	T496B106(1)006(2)(3)(4)(5)(6)	0.6	6	3.5	N/A	1
6.3	22	B/3528-21	T496B226(1)006(2)(3)(4)(5)(6)	1.3	6	3.5	1.5	1
6.3	15	C/6032-28	T496C156(1)006(2)(3)(4)(5)(6)	0.9	6	2	N/A	1
6.3	22	C/6032-28	T496C226(1)006(2)(3)(4)(5)(6)	1.4	6	2	N/A	1
6.3	33	C/6032-28	T496C336(1)006(2)(3)(4)(5)(6)	2	6	2	0.6	1
6.3	47	C/6032-28	T496C476(1)006(2)(3)(4)(5)(6)	2.9	6	1.6	0.6	1
6.3	47	D/7343-31	T496D476(1)006(2)(3)(4)(5)(6)	2.9	6	1	N/A	1
6.3	68	C/6032-28	T496C686(1)006(2)(3)(4)(5)(6)	4.1	6	1.2	N/A	1
6.3	68	D/7343-31	T496D686(1)006(2)(3)(4)(5)(6)	4.1	6	1	N/A	1
6.3	100	C/6032-28	T496C107(1)006(2)(3)(4)(5)(6)	6	8	0.4	N/A	1
6.3	100	D/7343-31	T496D107(1)006(2)(3)(4)(5)(6)	6	8	0.8	0.4	1
6.3	100	X/7343-43	T496X107(1)006(2)(3)(4)(5)(6)	6	8	0.9	0.3	1
6.3	150	D/7343-31	T496D157(1)006(2)(3)(4)(5)(6)	9	8	0.7	0.3	1
6.3	150	X/7343-43	T496X157(1)006(2)(3)(4)(5)(6)	9	8	0.3	N/A	1
6.3	220	X/7343-43	T496X227(1)006(2)(3)(4)(5)(6)	13.2	8	0.7	0.3	1
6.3	220	D/7343-31	T496D227(1)006(2)(3)(4)(5)(6)	13.2	8	0.7	0.3	1
6.3	330	X/7343-43	T496X337(1)006(2)(3)(4)(5)(6)	19.8	8	0.5	0.3	1
10	3.3	B/3528-21	T496B335(1)010(2)(3)(4)(5)(6)	0.5	6	3.5	N/A	1
10	4.7	B/3528-21	T496B475(1)010(2)(3)(4)(5)(6)	0.5	6	3.5	N/A	1
10	6.8	B/3528-21	T496B685(1)010(2)(3)(4)(5)(6)	0.7	6	3.5	N/A	1
10	10	C/6032-28	T496C106(1)010(2)(3)(4)(5)(6)	1	6	2	N/A	1
10	15	B/3528-21	T496B156(1)010(2)(3)(4)(5)(6)	1.5	6	3.5	N/A	1
10	15	C/6032-28	T496C156(1)010(2)(3)(4)(5)(6)	1.5	6	2	0.6	1
10	22	C/6032-28	T496C226(1)010(2)(3)(4)(5)(6)	2.2	6	2	0.5	1
10	33	C/6032-28	T496C336(1)010(2)(3)(4)(5)(6)	3.3	6	1.6	0.4	1
10	33	D/7343-31	T496D336(1)010(2)(3)(4)(5)(6)	3.3	6	1	0.4	1
10	47	C/6032-28	T496C476(1)010(2)(3)(4)(5)(6)	4.7	6	1.2	0.4	1
10	47	D/7343-31	T496D476(1)010(2)(3)(4)(5)(6)	4.7	6	1	0.4	1
10	68	D/7343-31	T496D686(1)010(2)(3)(4)(5)(6)	6.8	6	0.8	0.4	1
10	68	X/7343-43	T496X686(1)010(2)(3)(4)(5)(6)	6.8	6	0.9	N/A	1
10	100	D/7343-31	T496D107(1)010(2)(3)(4)(5)(6)	10	8	0.7	0.4	1
10	100	X/7343-43	T496X107(1)010(2)(3)(4)(5)(6)	10	8	0.4	N/A	1
10	150	D/7343-31	T496D157(1)010(2)(3)(4)(5)(6)	15	8	0.7	0.4	1
10	150	X/7343-43	T496X157(1)010(2)(3)(4)(5)(6)	15	8	0.7	0.4	1
10	220	X/7343-43	T496X227(1)010(2)(3)(4)(5)(6)	22	8	0.5	0.3	1
16	2.2	B/3528-21	T496B225(1)016(2)(3)(4)(5)(6)	0.5	6	3.5	3.5	1
16	3.3	B/3528-21	T496B335(1)016(2)(3)(4)(5)(6)	0.5	6	3.5	2.1	1
16	4.7	B/3528-21	T496B475(1)016(2)(3)(4)(5)(6)	0.8	6	3.5	1.6	1
16	6.8	C/6032-28	T496C685(1)016(2)(3)(4)(5)(6)	1.1	6	2	0.6	1
V	µF	KEMET/EIA	(See below for part options)	µA @ +20°C Maximum/5 Min	% @ +20°C 120 Hz Maximum	Ω @ +20°C 100 kHz Maximum	Ω @ +20°C 100 kHz Maximum	Temperature ≤ 260°C
Rated Voltage	Rated Capacitance	Case Code/ Case Size	KEMET Part Number	DC Leakage	DF	Standard ESR	Low ESR	Moisture Sensitivity

(1) To complete KEMET part number, insert M for ±20%, K for ±10%. Designates Capacitance tolerance.

(2) To complete KEMET part number, insert C (0.01%/1,000 hours). Designates Reliability Level.

(3) To complete KEMET part number, insert C = Hot Solder Dipped, H = Solder Plated or T = 100% Tin (Sn). Designates Termination Finish.

(4) To complete KEMET part number, insert 61 = None, 62 = 10 cycles +25°C, 63 = 10 cycles -55°C +85°C after Weibull, 64 = 10 cycles -55°C +85°C before Weibull or 65 = Both. Designates Surge current option.

(5) To complete KEMET part number, insert 1 = Standard ESR, 2 = Low ESR. Designates ESR option.

(6) To complete KEMET part number, insert A = Option 1, B = Option 2 or C = Option 3. Designates Test Option. See Space Grade Test Methods chart for more information.

Refer to Ordering Information for additional detail.

Table 1 – Ratings & Part Number Reference cont'd

Rated Voltage	Rated Capacitance	Case Code/ Case Size	KEMET Part Number	DC Leakage	DF	Standard ESR	Low ESR	Moisture Sensitivity
V	µF	KEMET/EIA	(See below for part options)	µA @ +20°C Maximum/5 Min	% @ +20°C 120 Hz Maximum	Ω @ +20°C 100 kHz Maximum	Ω @ +20°C 100 kHz Maximum	Temperature ≤ 260°C
16	10	C/6032-28	T496C106(1)016(2)(3)(4)(5)(6)	1.6	6	2	0.7	1
16	15	C/6032-28	T496C156(1)016(2)(3)(4)(5)(6)	2.4	6	2	0.6	1
16	22	C/6032-28	T496C226(1)016(2)(3)(4)(5)(6)	3.6	6	1.6	1	1
16	22	D/7343-31	T496D226(1)016(2)(3)(4)(5)(6)	3.6	6	1	0.5	1
16	33	D/7343-31	T496D336(1)016(2)(3)(4)(5)(6)	5.3	6	1	0.4	1
16	47	D/7343-31	T496D476(1)016(2)(3)(4)(5)(6)	7.5	6	0.8	0.4	1
16	47	X/7343-43	T496X476(1)016(2)(3)(4)(5)(6)	7.5	6	0.9	0.4	1
16	68	D/7343-31	T496D686(1)016(2)(3)(4)(5)(6)	10.9	8	0.4	N/A	1
20	1.5	B/3528-21	T496B155(1)020(2)(3)(4)(5)(6)	0.5	6	5	N/A	1
20	2.2	B/3528-21	T496B225(1)020(2)(3)(4)(5)(6)	0.5	6	3.5	1.6	1
20	4.7	C/6032-28	T496C475(1)020(2)(3)(4)(5)(6)	1	6	2	N/A	1
20	6.8	C/6032-28	T496C685(1)020(2)(3)(4)(5)(6)	1.4	6	2	0.6	1
20	10	C/6032-28	T496C106(1)020(2)(3)(4)(5)(6)	2	6	2	0.8	1
20	15	C/6032-28	T496C156(1)020(2)(3)(4)(5)(6)	3	6	0.5	N/A	1
20	15	D/7343-31	T496D156(1)020(2)(3)(4)(5)(6)	3	6	1	0.5	1
20	22	D/7343-31	T496D226(1)020(2)(3)(4)(5)(6)	4.4	6	1	0.5	1
20	33	D/7343-31	T496D336(1)020(2)(3)(4)(5)(6)	6.6	6	0.4	0.4	1
20	33	X/7343-43	T496X336(1)020(2)(3)(4)(5)(6)	6.6	6	0.9	0.4	1
25	0.68	B/3528-21	T496B684(1)025(2)(3)(4)(5)(6)	0.5	4	6.5	N/A	1
25	1	B/3528-21	T496B105(1)025(2)(3)(4)(5)(6)	0.5	4	5	3.5	1
25	1.5	B/3528-21	T496B155(1)025(2)(3)(4)(5)(6)	0.5	6	5	1.6	1
25	2.2	C/6032-28	T496C225(1)025(2)(3)(4)(5)(6)	0.6	6	3.5	N/A	1
25	3.3	C/6032-28	T496C335(1)025(2)(3)(4)(5)(6)	0.9	6	2.5	2.1	1
25	4.7	B/3528-21	T496B475(1)025(2)(3)(4)(5)(6)	1.2	6	4	N/A	1
25	4.7	C/6032-28	T496C475(1)025(2)(3)(4)(5)(6)	1.2	6	2.5	1.3	1
25	6.8	C/6032-28	T496C685(1)025(2)(3)(4)(5)(6)	1.7	6	2	0.6	1
25	10	D/7343-31	T496D106(1)025(2)(3)(4)(5)(6)	2.5	6	1.2	0.6	1
25	15	C/6032-28	T496C156(1)025(2)(3)(4)(5)(6)	3.8	6	0.75	N/A	1
25	15	D/7343-31	T496D156(1)025(2)(3)(4)(5)(6)	3.8	6	1	0.5	1
25	22	D/7343-31	T496D226(1)025(2)(3)(4)(5)(6)	5.5	6	0.8	0.4	1
25	22	X/7343-43	T496X226(1)025(2)(3)(4)(5)(6)	5.5	6	0.9	0.4	1
35	0.47	B/3528-21	T496B474(1)035(2)(3)(4)(5)(6)	0.5	4	8	2.6	1
35	0.68	B/3528-21	T496B684(1)035(2)(3)(4)(5)(6)	0.5	4	6.5	N/A	1
35	1	B/3528-21	T496B105(1)035(2)(3)(4)(5)(6)	0.5	4	5	3.1	1
35	1.5	C/6032-28	T496C155(1)035(2)(3)(4)(5)(6)	0.5	6	4.5	2.6	1
35	2.2	C/6032-28	T496C225(1)035(2)(3)(4)(5)(6)	0.8	6	3.5	1.6	1
35	3.3	C/6032-28	T496C335(1)035(2)(3)(4)(5)(6)	1.2	6	2.5	0.9	1
35	4.7	D/7343-31	T496D475(1)035(2)(3)(4)(5)(6)	1.7	6	1.5	0.7	1
35	6.8	D/7343-31	T496D685(1)035(2)(3)(4)(5)(6)	2.4	6	1.3	0.75	1
35	10	D/7343-31	T496D106(1)035(2)(3)(4)(5)(6)	3.5	6	0.5	N/A	1
35	10	X/7343-43	T496X106(1)035(2)(3)(4)(5)(6)	3.5	6	1	0.5	1
35	15	D/7343-31	T496D156(1)035(2)(3)(4)(5)(6)	5.3	6	0.5	N/A	1
35	15	X/7343-43	T496X156(1)035(2)(3)(4)(5)(6)	5.3	6	0.9	0.9	1
50	0.15	B/3528-21	T496B154(1)050(2)(3)(4)(5)(6)	0.5	4	16	N/A	1
50	0.22	B/3528-21	T496B224(1)050(2)(3)(4)(5)(6)	0.5	4	14	10	1
50	0.33	B/3528-21	T496B334(1)050(2)(3)(4)(5)(6)	0.5	4	10	2.6	1
50	0.47	C/6032-28	T496C474(1)050(2)(3)(4)(5)(6)	0.5	4	8	1.9	1
50	0.68	C/6032-28	T496C684(1)050(2)(3)(4)(5)(6)	0.5	4	7	1.7	1
50	1	C/6032-28	T496C105(1)050(2)(3)(4)(5)(6)	0.5	4	5.5	2.7	1
V	µF	KEMET/EIA	(See below for part options)	µA @ +20°C Maximum/5 Min	% @ +20°C 120 Hz Maximum	Ω @ +20°C 100 kHz Maximum	Ω @ +20°C 100 kHz Maximum	Temperature ≤ 260°C
Rated Voltage	Rated Capacitance	Case Code/ Case Size	KEMET Part Number	DC Leakage	DF	Standard ESR	Low ESR	Moisture Sensitivity

(1) To complete KEMET part number, insert M for ±20%, K for ±10%. Designates Capacitance tolerance.

(2) To complete KEMET part number, insert C (0.01%/1,000 hours). Designates Reliability Level.

(3) To complete KEMET part number, insert C = Hot Solder Dipped, H = Solder Plated or T = 100% Tin (Sn). Designates Termination Finish.

(4) To complete KEMET part number, insert 61 = None, 62 = 10 cycles +25°C, 63 = 10 cycles -55°C +85°C after Weibull, 64 = 10 cycles -55°C +85°C before Weibull or 65 = Both. Designates Surge current option.

(5) To complete KEMET part number, insert 1 = Standard ESR, 2 = Low ESR. Designates ESR option.

(6) To complete KEMET part number, insert A = Option 1, B = Option 2 or C = Option 3. Designates Test Option. See Space Grade Test Methods chart for more information.

Refer to Ordering Information for additional detail.

Table 1 – Ratings & Part Number Reference cont'd

Rated Voltage	Rated Capacitance	Case Code/ Case Size	KEMET Part Number	DC Leakage	DF	Standard ESR	Low ESR	Moisture Sensitivity
V	µF	KEMET/EIA	(See below for part options)	µA @ +20°C Maximum/5 Min	% @ +20°C 120 Hz Maximum	Ω @ +20°C 100 kHz Maximum	Ω @ +20°C 100 kHz Maximum	Temperature ≤ 260°C
50	1.5	C/6032-28	T496C155(1)050(2)(3)(4)(5)(6)	0.8	6	5	2	1
50	2.2	D/7343-31	T496D225(1)050(2)(3)(4)(5)(6)	1.1	6	2.5	0.9	1
50	3.3	D/7343-31	T496D335(1)050(2)(3)(4)(5)(6)	1.7	6	2	1	1
50	4.7	D/7343-31	T496D475(1)050(2)(3)(4)(5)(6)	2.4	6	0.4	N/A	1
50	4.7	X/7343-43	T496X475(1)050(2)(3)(4)(5)(6)	2.4	6	1.5	0.4	1
V	µF	KEMET/EIA	(See below for part options)	µA @ +20°C Maximum/5 Min	% @ +20°C 120 Hz Maximum	Ω @ +20°C 100 kHz Maximum	Ω @ +20°C 100 kHz Maximum	Temperature ≤ 260°C
Rated Voltage	Rated Capacitance	Case Code/ Case Size	KEMET Part Number	DC Leakage	DF	Standard ESR	Low ESR	Moisture Sensitivity

(1) To complete KEMET part number, insert M for ±20%, K for ±10%. Designates Capacitance tolerance.

(2) To complete KEMET part number, insert C (0.01%/1,000 hours). Designates Reliability Level.

(3) To complete KEMET part number, insert C= Hot Solder Dipped, H = Solder Plated or T = 100% Tin (Sn). Designates Termination Finish.

(4) To complete KEMET part number, insert 61 = None, 62 = 10 cycles +25°C, 63 = 10 cycles -55°C +85°C after Weibull, 64 = 10 cycles -55°C +85°C before Weibull or 65 = Both. Designates Surge current option.

(5) To complete KEMET part number, insert 1 = Standard ESR, 2 = Low ESR. Designates ESR option.

(6) To complete KEMET part number, insert A = Option 1, B = Option 2 or C = Option 3. Designates Test Option. See Space Grade Test Methods chart for more information.

Refer to Ordering Information for additional detail.

Recommended Voltage Derating Guidelines

	-55°C to 85°C	85°C to 125°C
% Change in Working DC Voltage with Temperature	V _R	67% of V _R
Recommended Maximum Application Voltage	50% of V _R	33% of V _R

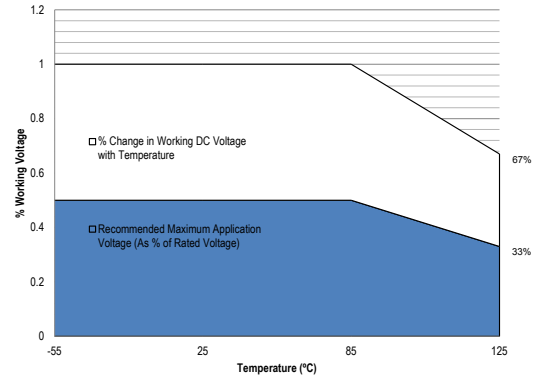

Ripple Current/Ripple Voltage

Permissible AC ripple voltage and current are related to equivalent series resistance (ESR) and the power dissipation capabilities of the device. Permissible AC ripple voltage which may be applied is limited by two criteria:

1. The positive peak AC voltage plus the DC bias voltage, if any, must not exceed the DC voltage rating of the capacitor.
2. The negative peak AC voltage in combination with bias voltage, if any, must not exceed the allowable limits specified for reverse voltage. See the Reverse Voltage section for allowable limits.

The maximum power dissipation by case size can be determined using the table at right. The maximum power dissipation rating stated in the table must be reduced with increasing environmental operating temperatures. Refer to the table below for temperature compensation requirements.

KEMET Case Code	EIA Case Code	Maximum Power Dissipation (P max) mWatts @ 25°C w/+20°C Rise
B	3528-21	85
C	6032-28	110
D	7343-31	150
X	7343-43	165

The maximum power dissipation rating must be reduced with increasing environmental operating temperatures. Refer to the Temperature Compensation Multiplier table for details.

Temperature Compensation Multipliers for Maximum Ripple Current		
T ≤ 25°C	T ≤ 85°C	T ≤ 125°C
1.00	0.90	0.40

T = Environmental Temperature

Using the P max of the device, the maximum allowable rms ripple current or voltage may be determined.

$$I(max) = \sqrt{P_{max}/R}$$

$$E(max) = Z \sqrt{P_{max}/R}$$

I = rms ripple current (amperes)

E = rms ripple voltage (volts)

P max = maximum power dissipation (watts)

R = ESR at specified frequency (ohms)

Z = Impedance at specified frequency (ohms)

Reverse Voltage

Solid tantalum capacitors are polar devices and may be permanently damaged or destroyed if connected with the wrong polarity. The positive terminal is identified on the capacitor body by a stripe plus in some cases a beveled edge. A small degree of transient reverse voltage is permissible for short periods per the table. The capacitors should not be operated continuously in reverse mode, even within these limits.

Temperature	Permissible Transient Reverse Voltage
25°C	15% of Rated Voltage
85°C	5% of Rated Voltage
125°C	1% of Rated Voltage

Table 2 – Land Dimensions/Courtyard

KEMET Case	Metric Size Code EIA	Density Level A: Maximum (Most) Land Protrusion (mm)					Density Level B: Median (Nominal) Land Protrusion (mm)					Density Level C: Minimum (Least) Land Protrusion (mm)				
		W	L	S	V1	V2	W	L	S	V1	V2	W	L	S	V1	V2
B	3528-21	2.35	2.21	0.92	6.32	4.00	2.23	1.80	1.12	5.22	3.50	2.13	1.42	1.28	4.36	3.24
C	6032-28	2.35	2.77	2.37	8.92	4.50	2.23	2.37	2.57	7.82	4.00	2.13	1.99	2.73	6.96	3.74
D	7343-31	2.55	2.77	3.67	10.22	5.60	2.43	2.37	3.87	9.12	5.10	2.33	1.99	4.03	8.26	4.84
X ¹	7343-43	2.55	2.77	3.67	10.22	5.60	2.43	2.37	3.87	9.12	5.10	2.33	1.99	4.03	8.26	4.84

Density Level A: For low-density product applications. Recommended for wave solder applications and provides a wider process window for reflow solder processes.

Density Level B: For products with a moderate level of component density. Provides a robust solder attachment condition for reflow solder processes.

Density Level C: For high component density product applications. Before adapting the minimum land pattern variations the user should perform qualification testing based on the conditions outlined in IPC Standard 7351 (IPC-7351).

¹ Height of these chips may create problems in wave soldering.

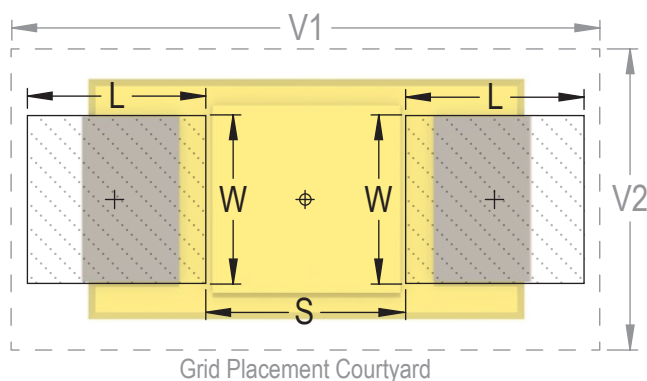

Soldering Process

KEMET's families of surface mount capacitors are compatible with wave (single or dual), convection, IR, or vapor phase reflow techniques. Preheating of these components is recommended to avoid extreme thermal stress. KEMET's recommended profile conditions for convection and IR reflow reflect the profile conditions of the IPC/J-STD-020D standard for moisture sensitivity testing. The devices can safely withstand a maximum of three reflow passes at these conditions.

Please note that although the X/7343-43 case size can withstand wave soldering, the tall profile (4.3 mm maximum) dictates care in wave process development.

Hand soldering should be performed with care due to the difficulty in process control. If performed, care should be taken to avoid contact of the soldering iron to the molded case. The iron should be used to heat the solder pad, applying solder between the pad and the termination, until reflow occurs. Once reflow occurs, the iron should be removed immediately. "Wiping" the edges of a chip and heating the top surface is not recommended.

During typical reflow operations, a slight darkening of the gold-colored epoxy may be observed. This slight darkening is normal and not harmful to the product. Marking permanency is not affected by this change.

Profile Feature	SnPb Assembly	Pb-Free Assembly
Preheat/Soak		
Temperature Minimum (T_{smin})	100°C	150°C
Temperature Maximum (T_{smax})	150°C	200°C
Time (t_s) from T_{smin} to T_{smax}	60 – 120 seconds	60 – 120 seconds
Ramp-up Rate (T_L to T_p)	3°C/seconds maximum	3°C/seconds maximum
Liquidous Temperature (T_L)	183°C	217°C
Time Above Liquidous (t_L)	60 – 150 seconds	60 – 150 seconds
Peak Temperature (T_p)	220°C* 235°C**	250°C* 260°C**
Time within 5°C of Maximum Peak Temperature (t_p)	20 seconds maximum	30 seconds maximum
Ramp-down Rate (T_p to T_L)	6°C/seconds maximum	6°C/seconds maximum
Time 25°C to Peak Temperature	6 minutes maximum	8 minutes maximum

Note: All temperatures refer to the center of the package, measured on the package body surface that is facing up during assembly reflow.

*Case Size D, E, P, Y, and X

**Case Size A, B, C, H, I, K, M, R, S, T, U, V, W, and Z

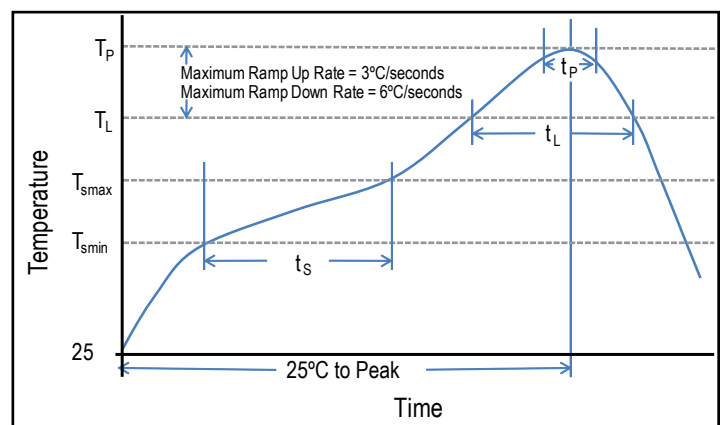

Storage

Tantalum chip capacitors should be stored in normal working environments. While the chips themselves are quite robust in other environments, solderability will be degraded by exposure to high temperatures, high humidity, corrosive atmospheres, and long term storage. In addition, packaging materials will be degraded by high temperature—reels may soften or warp and tape peel force may increase. KEMET recommends that maximum storage temperature not exceed 40°C and maximum storage humidity not exceed 60% relative humidity. Temperature fluctuations should be minimized to avoid condensation on the parts and atmospheres should be free of chlorine and sulphur bearing compounds. For optimized solderability chip stock should be used promptly, preferably within three years of receipt.

Construction

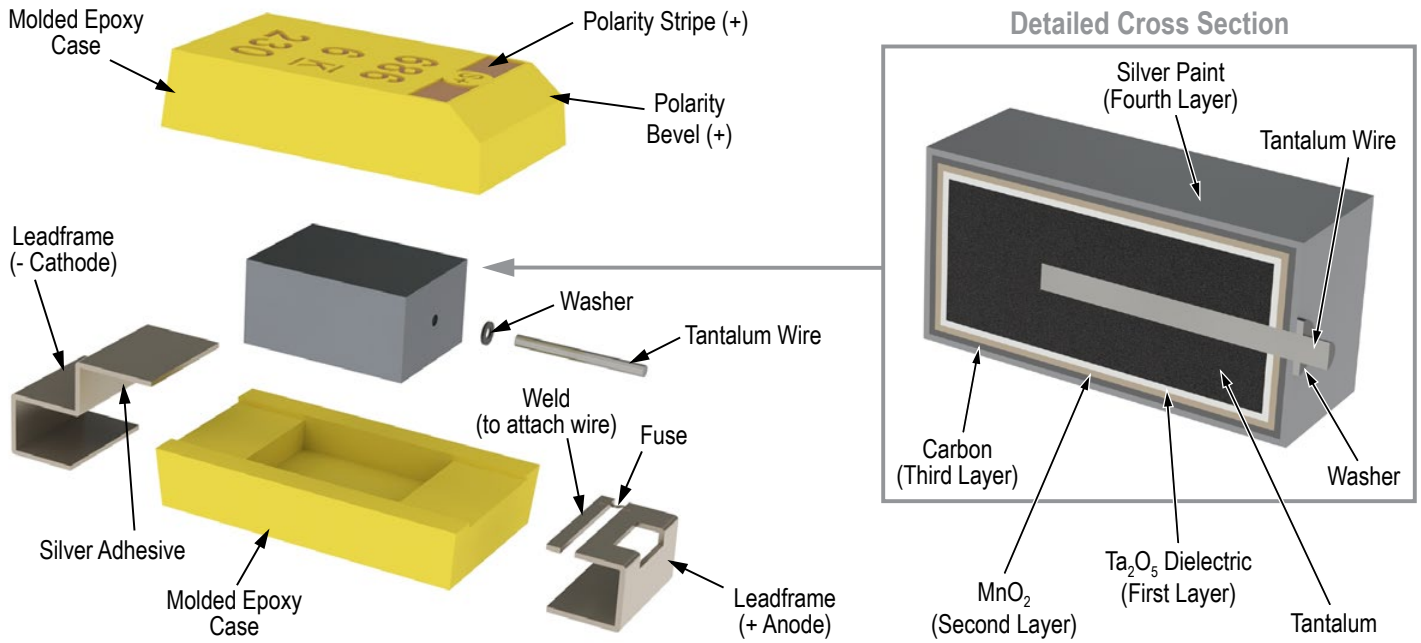

Capacitor Marking

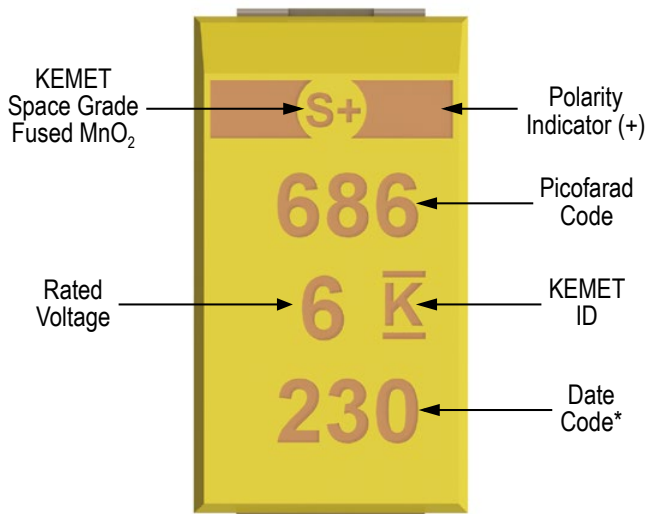

* 230 = 30th week of 2012

Date Code *	
1 st digit = Last number of Year	9 = 2009 0 = 2010 1 = 2011 2 = 2012 3 = 2013 4 = 2014
2 nd and 3 rd digit = Week of the Year	01 = 1 st week of the Year to 52 = 52 nd week of the Year

Overview

KEMET's Space Grade Series of capacitors are suitable for use by defense/aerospace customers in high reliability space applications. This series meets the requirements of MIL-PRF-55365 as well as MIL-STD-1580. These capacitors incorporate an intensive testing and screening protocol which is customizable depending upon customer's specific needs. The full part number allows for designation of Weibull grading level

(B=0.1%/k hours or C=0.01%/k hours), surge current level (10 cycles -55°C and +85°C before and/or after Weibull grading), performance testing level (see chart for details on available options), ESR (low and standard), and termination finish (see description in each series). Fused versions are available for built-in circuit protection, as well as multi-anode designs for very low ESR values.

Benefits

- Low profile case sizes
- 100% thermal shock
- 100% surge current test available on all case sizes
- Various termination finishes available
- Weibull Grading C (0.01%/1,000 hours)
- Operating temperature range of -55°C to +125°C
- Capacitance values of 0.1 μ F to 150 μ F
- Voltage rating of 4 – 50 VDC

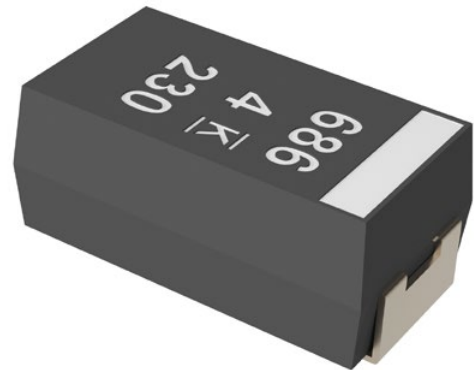

Applications

Typical applications include decoupling and filtering in medical, defense, and aerospace applications.

Environmental Compliance

RoHS Compliant (6/6) according to Directive 2002/95/EC when ordered with 100% Sn solder.



RoHS Compliant

SPICE

For a detailed analysis of specific part numbers, please visit www.kemet.com for a free download of KEMET's SPICE software. The KEMET SPICE program is freeware intended to aid design engineers in analyzing the performance of these capacitors over frequency, temperature, ripple, and DC bias conditions.

Ordering Information

T	497	G	226	K	020	C	H	61	2	A
Capacitor Class	Series	Case Size	Capacitance Code (pF)	Capacitance Tolerance	Voltage	Failure Rate/Design	Lead Material	Surge	ESR	Testing
T = Tantalum	High Grade - Space Grade	A, B, C, D, E, F, G, H, X	First two digits represent significant figures. Third digit specifies number of zeros.	K = ±10% M = ±20%	004 = 4 V 006 = 6.3 V 010 = 10 V 015 = 15 V 020 = 20 V 025 = 25 V 035 = 35 V 050 = 50 V	C = 0.01%/1,000 hours	C = Hot Solder Dipped T = 100% Matte Tin (Sn) Plated H = Standard Solder Coated (SnPb 5% Pb minimum) B = Gold Plated	61 = None 62 = 10 Cycles after Weibull, 25°C 63 = 10 Cycles, after Weibull, -55°C and 85°C 64 = 10 Cycles before Weibull, -55°C and 85°C 65 = 10 Cycles Before and After Weibull, -55°C and 85°C	1 = ESR - Standard 2 = ESR - Low	A = Option A B = Option B C = Option C

Performance Characteristics

Item	Performance Characteristics
Operating Temperature	-55°C to 125°C
Rated Capacitance Range	0.1 – 150 µF @ 120 Hz/25°C
Capacitance Tolerance	K Tolerance (10%), M Tolerance (20%)
Rated Voltage Range	4 – 50 V
DF (120 Hz)	Refer to Part Number Electrical Specification Table
ESR (100 kHz)	Refer to Part Number Electrical Specification Table
Leakage Current	≤ 0.01CV (µA) at rated voltage after 5 minutes

Qualification

Test	Condition	Characteristics				
Endurance	105°C @ rated voltage, 2,000 hours 125°C @ 2/3 rated voltage, 2,000 hours	Δ C/C	Within -20%/+10% of initial value			
		DF	≤ Initial Limit			
		DCL	2 x IL @ 125°C			
		ESR	2 x Initial Limit			
Storage Life	125°C @ 0 volts, 2,000 hours	Δ C/C	Within -20%/+10% of initial value			
		DF	Within initial limits			
		DCL	Within 2.0 x initial limit			
		ESR	Within 2.0 x initial limit			
Humidity	85°C, 85% RH, 1,000 hours, No Load	Δ C/C	Within -5%/+35% of initial value			
		DF	≤ Initial Limit			
		DCL	Within 3.0 x initial limit			
Temperature Stability	Extreme temperature exposure at a succession of continuous steps at +25°C, -55°C, +25°C, +85°C, +125°C, +25°C		+25°C	-55°C	+85°C	+125°C
		Δ C/C	IL*	±20%	±20%	±30%
		DF	IL	IL	1.2 x IL	1.5 x IL
Surge Voltage	105°C, 1.32 x rated voltage 1,000 cycles	Δ C/C	Within -20%/+10% of initial value			
		DF	Within initial limits			
		DCL	Within initial limits			
		ESR	Within initial limits			
Mechanical Shock/Vibration	MIL-STD-202, Method 213, Condition I, 100 G peak. MIL-STD-202, Method 204, Condition D, 10 Hz to 2,000 Hz, 20 G peak	Δ C/C	Within ±10% of initial value			
		DF	Within initial limits			
		DCL	Within initial limits			

*IL = Initial Limit

Test Methods

Test Sequence	Test Method	Option A	Option B	Option C
100% Serialization	KEMET Standard			X
100% IR Reflow	MIL-PRF-55365	X	X	X
100% Thermal Shock	MIL-PRF-55365	X	X	X
100% Electrical Verification	KEMET Standard	X		X
Read and Record Attributes/Variables Data	KEMET Standard			X
100% Surge Current, Option C with 5% PDA Calculation	MIL-PRF-55365 with 5% PDA Calculation	X	X	X
100% Electrical Verification	KEMET Standard		X	X
Read and Record Attributes/Variables Data	KEMET Standard			X
100% Voltage Aging, 10 hours @1.32 Vr	MIL-PRF-55365		X	X
100% Electrical Verification	KEMET Standard		X	X
100% Weibull Grading B or C	MIL-PRF-55365	X	X	X
100% Electrical Verification	KEMET Standard	X	X	X
Read and Record Attributes/Variables Data	KEMET Standard			X
100% Surge Current, Option A or B with 5% PDA Calculation	MIL-PRF-55365 with 5% PDA Calculation	X	X	X
100% Electrical Verification	KEMET Standard	X	X	X
Read and Record Attributes/Variables Data	KEMET Standard			X
3 Sigma Screening - All Electricals	KEMET Standard	X	X	X
Read and Record Attributes/Variables Data	KEMET Standard			X
Destructive Physical Analysis (DPA) (5 pieces- each lot)	MIL-PRF-55365	X	X	X
Group B Testing (22 pieces - each lot)	* See Note Below		X	X
Temperature Stability - sample	MIL-PRF-55365	X	X	X
Solderability - Sample	MIL-PRF-55365	X	X	X
Group C Testing (57 pieces - each Lot)**	MIL-PRF-55365		X	X
100% X-ray	MIL-PRF-55365	X		
100% X-ray - 2 Plane***	MIL-PRF-55365 and KEMET Standard		X	X
100% Physical Dimension Verification	MIL-PRF-55365	X	X	X
Data Pack				
Group A and C Summaries			X	X
2 Plane X-ray JPEG photos			X	X
DPA Report			X	X
Attributes/Variables Data for Cap/Df/DCL/ESR				X

X = Included in test option

* Group B Testing = 10,000 Cycles Surge Current, 85°C, 40% Vr

** Group C Post Moisture ESR limit = 1.25 initial limit

*** 2 Plane X-ray = Top and side views, molded case wall thickness minimum 0.005" on all sides, negative/positive termination attachment criteria per MIL- STD-1580

Electrical Characteristics

ESR vs. Frequency

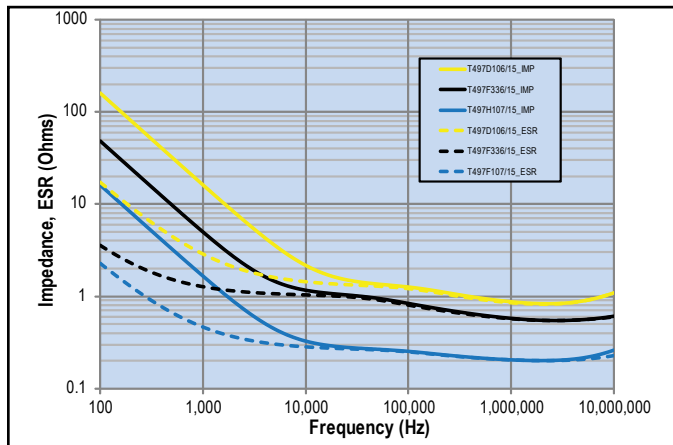

Capacitance vs. Frequency

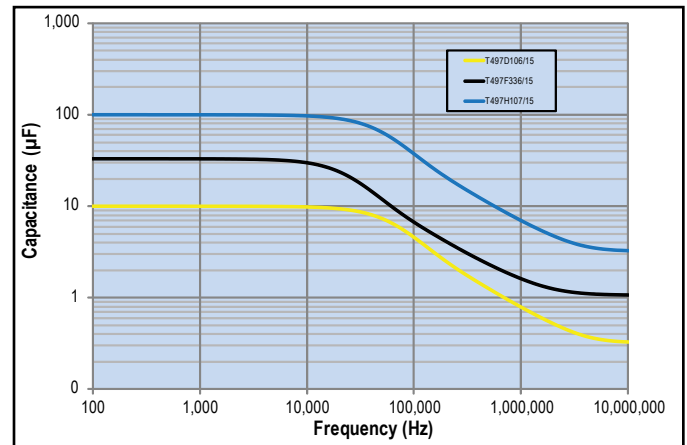

Dimensions – Millimeters (Inches)

Metric will govern

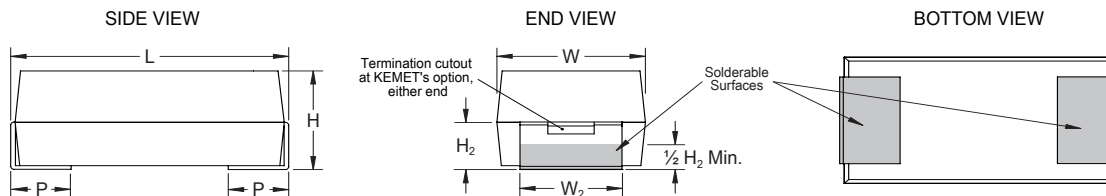

Case Size	Component					
KEMET	$L^* \pm 0.38$ (0.015)	$W^* \pm 0.38$ (0.015)	$H^* \pm 0.38$ (0.015)	$P +0.25$ (0.010), -0.13 (0.005)	W_2	H_2 Minimum
A	2.54 (.100)	1.27 (.050)	1.27 (.050)	0.76 (.030)	1.27 ± 0.13 (0.050 ± 0.005)	0.76 (0.030)
B	3.81 (.150)	1.27 (.050)	1.27 (.050)	0.76 (.030)	1.27 ± 0.13 (0.050 ± 0.005)	0.76 (0.030)
C	5.08 (.200)	1.27 (.050)	1.27 (.050)	0.76 (.030)	1.27 ± 0.13 (0.050 ± 0.005)	0.76 (0.030)
D	3.81 (.150)	2.54 (.100)	1.27 (.050)	0.76 (.030)	$2.41 +0.13, -0.25$ ($0.095 +0.005, -0.010$)	0.76 (0.030)
E	5.08 (.200)	2.54 (.100)	1.27 (.050)	0.76 (.030)	$2.41 +0.13, -0.25$ ($0.095 +0.005, -0.010$)	0.76 (0.030)
F	5.59 (.220)	3.43 (.135)	1.78 (.070)	0.76 (.030)	3.30 ± 0.13 (0.130 ± 0.005)	1.02 (0.040)
G	6.73 (.265)	2.79 (.110)	2.79 (.110)	1.27 (.050)	2.67 ± 0.13 (0.105 ± 0.005)	1.52 (0.060)
H	7.24 (.285)	3.81 (.150)	2.79 (.110)	1.27 (.050)	$3.68 +0.013, -0.51$ ($0.145 +0.005, -0.020$)	1.52 (0.060)
X	6.93 (.273)	5.41 (.213)	2.74 (.108)	1.19 (.047)	3.05 ± 0.13 (0.120 ± 0.005)	1.22 (0.048)

Note: When solder coated terminations are required, add an additional 0.38 mm (0.015 inch) to the above tolerances for "L", "W", "H", "P", "W₂" and "H₂"

Table 1 – Ratings & Part Number Reference

Rated Voltage	Rated Cap	Case Code/ Case Size	KEMET Part Number	DC Leakage	DF	Standard ESR	Low ESR	Moisture Sensitivity
V	µF	KEMET/EIA	(See below for part options)	µA @ +20°C Maximum/5 Min	% @ +20°C 120 Hz Maximum	Ω @ +20°C 100 kHz Maximum	Ω @ +20°C 100 kHz Maximum	Temperature ≤ 260°C
4	2.2	A/1005	T497A225(1)004(2)(3)(4)(5)(6)	1	6	8	4	1
4	3.3	A/1005	T497A335(1)004(2)(3)(4)(5)(6)	1	6	12	6	1
4	4.7	A/1005	T497A475(1)004(2)(3)(4)(5)(6)	1	6	12	6	1
4	6.8	A/1005	T497A685(1)004(2)(3)(4)(5)(6)	1	6	12	6	1
4	4.7	B/1505	T497B475(1)004(2)(3)(4)(5)(6)	1	6	8	3.2	1
4	10	B/1505	T497B106(1)004(2)(3)(4)(5)(6)	1	8	8	3.2	1
4	15	B/1505	T497B156(1)004(2)(3)(4)(5)(6)	1	8	8	3.2	1
4	6.8	C/2005	T497C685(1)004(2)(3)(4)(5)(6)	1	6	5.5	2.2	1
4	10	D/1510	T497D106(1)004(2)(3)(4)(5)(6)	1	8	4	1.3	1
4	22	D/1510	T497D226(1)004(2)(3)(4)(5)(6)	1	8	4	1.3	1
4	33	D/1510	T497D336(1)004(2)(3)(4)(5)(6)	2	8	4	1.3	1
4	15	E/2010	T497E156(1)004(2)(3)(4)(5)(6)	1	8	3.5	1	1
4	33	E/2010	T497E336(1)004(2)(3)(4)(5)(6)	2	8	3	0.9	1
4	47	E/2010	T497E476(1)004(2)(3)(4)(5)(6)	2	8	3	0.9	1
4	68	E/2010	T497E686(1)004(2)(3)(4)(5)(6)	3	8	3	0.9	1
4	33	F/2214	T497F336(1)004(2)(3)(4)(5)(6)	2	8	2.2	0.6	1
4	100	F/2214	T497F107(1)004(2)(3)(4)(5)(6)	4	10	2	0.55	1
4	68	G/2711	T497G686(1)004(2)(3)(4)(5)(6)	3	10	1.1	0.275	1
4	150	G/2711	T497G157(1)004(2)(3)(4)(5)(6)	6	10	1	0.25	1
4	100	H/2915	T497H107(1)004(2)(3)(4)(5)(6)	4	10	0.9	0.18	1
4	220	H/2915	T497H227(1)004(2)(3)(4)(5)(6)	8	10	1	0.2	1
4	330	H/2915	T497H337(1)004(2)(3)(4)(5)(6)	10	10	0.9	0.18	1
6.3	1.5	A/1005	T497A155(1)006(2)(3)(4)(5)(6)	1	6	8	4	1
6.3	3.3	A/1005	T497A335(1)006(2)(3)(4)(5)(6)	1	6	12	6	1
6.3	4.7	A/1005	T497A475(1)006(2)(3)(4)(5)(6)	1	6	12	6	1
6.3	3.3	B/1505	T497B335(1)006(2)(3)(4)(5)(6)	1	6	8	3.2	1
6.3	6.8	B/1505	T497B685(1)006(2)(3)(4)(5)(6)	1	6	8	3.2	1
6.3	10	B/1505	T497B106(1)006(2)(3)(4)(5)(6)	1	6	8	3.2	1
6.3	15	B/1505	T497B156(1)006(2)(3)(4)(5)(6)	1	8	8	3.2	1
6.3	4.7	C/2005	T497C475(1)006(2)(3)(4)(5)(6)	1	6	5.5	2.2	1
6.3	6.8	D/1510	T497D685(1)006(2)(3)(4)(5)(6)	1	6	4.5	1.5	1
6.3	15	D/1510	T497D156(1)006(2)(3)(4)(5)(6)	1	8	5	1.7	1
6.3	22	D/1510	T497D226(1)006(2)(3)(4)(5)(6)	1	6	5	1.7	1
6.3	10	E/2010	T497E106(1)006(2)(3)(4)(5)(6)	1	8	3.5	1	1
6.3	15	E/2010	T497E156(1)006(2)(3)(4)(5)(6)	1	8	3	0.9	1
6.3	22	E/2010	T497E226(1)006(2)(3)(4)(5)(6)	2	8	3.5	1	1
6.3	33	E/2010	T497E336(1)006(2)(3)(4)(5)(6)	2	6	3.5	1	1
6.3	22	F/2214	T497F226(1)006(2)(3)(4)(5)(6)	2	8	2.2	0.6	1
6.3	47	F/2214	T497F476(1)006(2)(3)(4)(5)(6)	3	8	3.5	1	1
6.3	68	F/2214	T497F686(1)006(2)(3)(4)(5)(6)	4	10	1.5	0.4	1
6.3	47	G/2711	T497G476(1)006(2)(3)(4)(5)(6)	3	10	1.1	0.275	1
6.3	68	G/2711	T497G686(1)006(2)(3)(4)(5)(6)	4	10	1	0.25	1
6.3	100	G/2711	T497G107(1)006(2)(3)(4)(5)(6)	6	10	1	0.275	1
6.3	150	G/2711	T497G157(1)006(2)(3)(4)(5)(6)	10	10	1.1	0.275	1
6.3	68	H/2915	T497H686(1)006(2)(3)(4)(5)(6)	4	10	0.9	0.18	1
6.3	220	H/2915	T497H227(1)006(2)(3)(4)(5)(6)	10	10	0.9	0.18	1
6.3	330	H/2915	T497H337(1)006(2)(3)(4)(5)(6)	20	10	0.9	0.18	1
V	µF	KEMET/EIA	(See below for part options)	µA @ +20°C Maximum/5 Min	% @ +20°C 120 Hz Maximum	Ω @ +20°C 100 kHz Maximum	Ω @ +20°C 100 kHz Maximum	Temperature ≤ 260°C
Rated Voltage	Rated Cap	Case Code/ Case Size	KEMET Part Number	DC Leakage	DF	Standard ESR	Low ESR	Moisture Sensitivity

- (1) To complete KEMET part number, insert M for ± 20%, K for ± 10%. Designates Capacitance tolerance.
- (2) To complete KEMET part number, insert C (0.01%/1000Hrs). Designates Reliability Level.
- (3) To complete KEMET part number, insert C = Hot Solder Dipped, B = Gold Plated, H = Solder Plated, or T = 100% Tin (Sn). Designates Termination Finish.
- (4) To complete KEMET part number, insert 61 = None, 62 = 10 cycles +25°C, 63 = 10 cycles -55°C +85°C after Weibull, 64 = 10 cycles -55°C +85°C before Weibull or 65 = Both. Designates Surge current option.
- (5) To complete KEMET part number, insert 1 = Standard ESR, 2 = Low ESR. Designates ESR option.
- (6) To complete KEMET part number, insert A = Option 1, B = Option 2 or C = Option 3. Designates Test Option. See Space Grade Test Methods chart for more information.

Refer to Ordering Information for additional detail.

Table 1 – Ratings & Part Number Reference cont'd

Rated Voltage	Rated Cap	Case Code/ Case Size	KEMET Part Number	DC Leakage	DF	Standard ESR	Low ESR	Moisture Sensitivity
V	µF	KEMET/EIA	(See below for part options)	µA @ +20°C Maximum/5 Min	% @ +20°C 120 Hz Maximum	Ω @ +20°C 100 kHz Maximum	Ω @ +20°C 100 kHz Maximum	Temperature ≤ 260°C
10	1	A/1005	T497A105(1)010(2)(3)(4)(5)(6)	1	6	10	5	1
10	2.2	A/1005	T497A225(1)010(2)(3)(4)(5)(6)	1	6	12	6	1
10	3.3	A/1005	T497A335(1)010(2)(3)(4)(5)(6)	1	6	12	6	1
10	2.2	B/1505	T497B225(1)010(2)(3)(4)(5)(6)	1	6	8	3.2	1
10	4.7	B/1505	T497B475(1)010(2)(3)(4)(5)(6)	1	6	8	3.2	1
10	6.8	B/1505	T497B685(1)010(2)(3)(4)(5)(6)	1	6	8	3.2	1
10	3.3	C/2005	T497C335(1)010(2)(3)(4)(5)(6)	1	6	5.5	2.2	1
10	4.7	C/2005	T497C475(1)010(2)(3)(4)(5)(6)	1	6	5.5	2.2	1
10	6.8	C/2005	T497C685(1)010(2)(3)(4)(5)(6)	1	6	5.5	2.2	1
10	10	C/2005	T497C106(1)010(2)(3)(4)(5)(6)	1	6	5.5	2.2	1
10	4.7	D/1510	T497D475(1)010(2)(3)(4)(5)(6)	1	6	4.5	1.5	1
10	6.8	D/1510	T497D685(1)010(2)(3)(4)(5)(6)	1	6	5	1.7	1
10	10	D/1510	T497D106(1)010(2)(3)(4)(5)(6)	1	6	4	1.3	1
10	15	D/1510	T497D156(1)010(2)(3)(4)(5)(6)	2	6	5	1.7	1
10	6.8	E/2010	T497E685(1)010(2)(3)(4)(5)(6)	1	6	3.5	1	1
10	10	E/2010	T497E106(1)010(2)(3)(4)(5)(6)	1	6	3.5	1	1
10	15	E/2010	T497E156(1)010(2)(3)(4)(5)(6)	2	8	3	0.9	1
10	15	F/2214	T497F156(1)010(2)(3)(4)(5)(6)	2	8	2.5	0.7	1
10	33	F/2214	T497F336(1)010(2)(3)(4)(5)(6)	3	8	1.5	0.4	1
10	47	F/2214	T497F476(1)010(2)(3)(4)(5)(6)	4	10	1.5	0.4	1
10	33	G/2711	T497G336(1)010(2)(3)(4)(5)(6)	3	10	1.1	0.275	1
10	47	G/2711	T497G476(1)010(2)(3)(4)(5)(6)	4	10	1	0.25	1
10	68	G/2711	T497G686(1)010(2)(3)(4)(5)(6)	6	10	1.1	0.275	1
10	100	G/2711	T497G107(1)010(2)(3)(4)(5)(6)	10	10	1.1	0.275	1
10	47	H/2915	T497H476(1)010(2)(3)(4)(5)(6)	5	10	0.9	0.18	1
10	100	H/2915	T497H107(1)010(2)(3)(4)(5)(6)	10	10	0.9	0.18	1
10	150	H/2915	T497H157(1)010(2)(3)(4)(5)(6)	15	10	0.9	0.18	1
10	220	H/2915	T497H227(1)010(2)(3)(4)(5)(6)	20	10	0.9	0.18	1
10	150	X/2824	T497X157(1)010(2)(30)(4)(5)(6)	15	10	0.9	0.065	1
15	0.68	A/1005	T497A684(1)015(2)(3)(4)(5)(6)	1	6	12	6	1
15	1.5	A/1005	T497A155(1)015(2)(3)(4)(5)(6)	1	6	15	7.5	1
15	2.2	A/1005	T497A225(1)015(2)(3)(4)(5)(6)	1	6	15	7.5	1
15	1.5	B/1505	T497B155(1)015(2)(3)(4)(5)(6)	1	6	8	3.2	1
15	2.2	C/2005	T497C225(1)015(2)(3)(4)(5)(6)	1	6	5.5	2.2	1
15	3.3	D/1510	T497D335(1)015(2)(3)(4)(5)(6)	1	6	5	1.7	1
15	4.7	D/1510	T497D475(1)015(2)(3)(4)(5)(6)	1	6	6	2	1
15	6.8	D/1510	T497D685(1)015(2)(3)(4)(5)(6)	1	6	6	2	1
15	4.7	E/2010	T497E475(1)015(2)(3)(4)(5)(6)	1	6	4	1.2	1
15	6.8	E/2010	T497E685(1)015(2)(3)(4)(5)(6)	1	8	3	0.9	1
15	10	F/2214	T497F106(1)015(2)(3)(4)(5)(6)	2	6	2.5	0.667	1
15	15	F/2214	T497F156(1)015(2)(3)(4)(5)(6)	2	8	3	0.8	1
15	22	F/2214	T497F226(1)015(2)(3)(4)(5)(6)	3	8	3	0.8	1
15	33	F/2214	T497F336(1)015(2)(3)(4)(5)(6)	5	6	3	0.8	1
15	22	G/2711	T497G226(1)015(2)(3)(4)(5)(6)	4	6	1.1	0.275	1
15	33	G/2711	T497G336(1)015(2)(3)(4)(5)(6)	6	8	1.1	0.275	1
15	47	G/2711	T497G476(1)015(2)(3)(4)(5)(6)	10	8	1.1	0.275	1
15	33	H/2915	T497H336(1)015(2)(3)(4)(5)(6)	5	8	0.9	0.18	1
V	µF	KEMET/EIA	(See below for part options)	µA @ +20°C Maximum/5 Min	% @ +20°C 120 Hz Maximum	Ω @ +20°C 100 kHz Maximum	Ω @ +20°C 100 kHz Maximum	Temperature ≤ 260°C
Rated Voltage	Rated Cap	Case Code/ Case Size	KEMET Part Number	DC Leakage	DF	Standard ESR	Low ESR	Moisture Sensitivity

(1) To complete KEMET part number, insert M for ± 20%, K for ± 10%. Designates Capacitance tolerance.

(2) To complete KEMET part number, insert C (0.01%/1000Hrs). Designates Reliability Level.

(3) To complete KEMET part number, insert C = Hot Solder Dipped, B = Gold Plated, H = Solder Plated, or T = 100% Tin (Sn). Designates Termination Finish.

(4) To complete KEMET part number, insert 61 = None, 62 = 10 cycles +25°C, 63 = 10 cycles -55°C +85°C after Weibull, 64 = 10 cycles -55°C +85°C before Weibull or 65 = Both. Designates Surge current option.

(5) To complete KEMET part number, insert 1 = Standard ESR, 2 = Low ESR. Designates ESR option.

(6) To complete KEMET part number, insert A = Option 1, B = Option 2 or C = Option 3. Designates Test Option. See Space Grade Test Methods chart for more information.

Refer to Ordering Information for additional detail.

Table 1 – Ratings & Part Number Reference cont'd

Rated Voltage	Rated Cap	Case Code/ Case Size	KEMET Part Number	DC Leakage	DF	Standard ESR	Low ESR	Moisture Sensitivity
V	µF	KEMET/EIA	(See below for part options)	µA @ +20°C Maximum/5 Min	% @ +20°C 120 Hz Maximum	Ω @ +20°C 100 kHz Maximum	Ω @ +20°C 100 kHz Maximum	Temperature ≤ 260°C
15	47	H/2915	T497H476(1)015(2)(3)(4)(5)(6)	10	8	0.9	0.18	1
15	68	H/2915	T497H686(1)015(2)(3)(4)(5)(6)	10	8	0.9	0.18	1
20	0.47	A/1005	T497A474(1)020(2)(3)(4)(5)(6)	1	8	14	7.5	1
20	0.68	B/1505	T497B684(1)020(2)(3)(4)(5)(6)	1	6	10	5.6	1
20	1	B/1505	T497B105(1)020(2)(3)(4)(5)(6)	1	6	12	4.8	1
20	1.5	C/2005	T497C155(1)020(2)(3)(4)(5)(6)	1	6	6	2.4	1
20	2.2	D/1510	T497D225(1)020(2)(3)(4)(5)(6)	1	6	5	1.7	1
20	3.3	D/1510	T497D335(1)020(2)(3)(4)(5)(6)	1	6	6	2	1
20	3.3	E/2010	T497E335(1)020(2)(3)(4)(5)(6)	1	6	4	1.2	1
20	4.7	E/2010	T497E475(1)020(2)(3)(4)(5)(6)	1	6	6	1.7	1
20	6.8	E/2010	T497E685(1)020(2)(3)(4)(5)(6)	2	6	5	1.5	1
20	6.8	F/2214	T497F685(1)020(2)(3)(4)(5)(6)	2	6	2.4	0.7	1
20	10	F/2214	T497F106(1)020(2)(3)(4)(5)(6)	2	6	3	0.8	1
20	15	G/2711	T497G156(1)020(2)(3)(4)(5)(6)	3	6	1.1	0.275	1
20	22	G/2711	T497G226(1)020(2)(3)(4)(5)(6)	4	6	2.5	0.625	1
20	22	H/2915	T497H226(1)020(2)(3)(4)(5)(6)	4	6	0.9	0.18	1
20	33	H/2915	T497H336(1)020(2)(3)(4)(5)(6)	6	8	0.9	0.18	1
20	47	X/2824	T497X476(1)020(2)(3)(4)(5)(6)	10	8	0.9	0.11	1
25	0.68	B/1505	T497B684(1)025(2)(3)(4)(5)(6)	1	6	7.5	4	1
25	1	B/1505	T497B105(1)025(2)(3)(4)(5)(6)	1	6	10	4	1
25	1	C/2005	T497C105(1)025(2)(3)(4)(5)(6)	1	6	6.5	2.6	1
25	1.5	D/1510	T497D155(1)025(2)(3)(4)(5)(6)	1	6	6.5	1.7	1
25	2.2	D/1510	T497D225(1)025(2)(3)(4)(5)(6)	1	6	6	2	1
25	2.2	E/2010	T497E225(1)025(2)(3)(4)(5)(6)	1	6	3.5	1	1
25	3.3	E/2010	T497E335(1)025(2)(3)(4)(5)(6)	1	6	4	1.2	1
25	4.7	F/2214	T497F475(1)025(2)(3)(4)(5)(6)	2	6	2.5	0.7	1
25	6.8	F/2214	T497F685(1)025(2)(3)(4)(5)(6)	2	6	3	0.8	1
25	6.8	G/2711	T497G685(1)025(2)(3)(4)(5)(6)	2	6	1.2	0.3	1
25	10	G/2711	T497G106(1)025(2)(3)(4)(5)(6)	3	6	1.4	0.35	1
25	15	G/2711	T497G156(1)025(2)(3)(4)(5)(6)	4	6	1.4	0.35	1
25	22	G/2711	T497G226(1)025(2)(3)(4)(5)(6)	6	6	1.4	0.35	1
25	15	H/2915	T497H156(1)025(2)(3)(4)(5)(6)	4	6	1	0.2	1
25	22	H/2915	T497H226(1)025(2)(3)(4)(5)(6)	6	6	0.9	0.18	1
25	33	H/2915	T497H336(1)025(2)(3)(4)(5)(6)	10	8	0.9	0.18	1
25	22	X/2824	T497X226(1)025(2)(3)(4)(5)(6)	6	6	0.9	0.16	1
25	33	X/2824	T497X336(1)025(2)(3)(4)(5)(6)	10	8	0.9	0.13	1
35	0.47	B/1505	T497B474(1)035(2)(3)(4)(5)(6)	1	6	10	6.8	1
35	0.68	C/2005	T497C684(1)035(2)(3)(4)(5)(6)	1	6	8	4	1
35	1	D/1510	T497D105(1)035(2)(3)(4)(5)(6)	1	6	6.5	2.2	1
35	1.5	E/2010	T497E155(1)035(2)(3)(4)(5)(6)	1	6	4.5	1.3	1
35	3.3	F/2214	T497F335(1)035(2)(3)(4)(5)(6)	1	6	2.5	0.7	1
35	4.7	G/2711	T497G475(1)035(2)(3)(4)(5)(6)	2	6	1.5	0.375	1
35	6.8	H/2915	T497H685(1)035(2)(3)(4)(5)(6)	3	6	1.3	0.5	1
35	10	H/2915	T497H106(1)035(2)(3)(4)(5)(6)	4	8	0.9	0.5	1
35	15	X/2824	T497X156(1)035(2)(3)(4)(5)(6)	6	6	0.9	0.19	1
50	0.1	A/1005	T497A104(1)050(2)(3)(4)(5)(6)	1	6	22	12	1
50	0.22	B/1505	T497B224(1)050(2)(3)(4)(5)(6)	1	6	14	6.8	1
V	µF	KEMET/EIA	(See below for part options)	µA @ +20°C Maximum/5 Min	% @ +20°C 120 Hz Maximum	Ω @ +20°C 100 kHz Maximum	Ω @ +20°C 100 kHz Maximum	Temperature ≤ 260°C
Rated Voltage	Rated Cap	Case Code/ Case Size	KEMET Part Number	DC Leakage	DF	Standard ESR	Low ESR	Moisture Sensitivity

(1) To complete KEMET part number, insert M for ± 20%, K for ± 10%. Designates Capacitance tolerance.

(2) To complete KEMET part number, insert C (0.01%/1000Hrs). Designates Reliability Level.

(3) To complete KEMET part number, insert C = Hot Solder Dipped, B = Gold Plated, H = Solder Plated, or T = 100% Tin (Sn). Designates Termination Finish.

(4) To complete KEMET part number, insert 61 = None, 62 = 10 cycles +25°C, 63 = 10 cycles -55°C +85°C after Weibull, 64 = 10 cycles -55°C +85°C before Weibull or 65 = Both. Designates Surge current option.

(5) To complete KEMET part number, insert 1 = Standard ESR, 2 = Low ESR. Designates ESR option.

(6) To complete KEMET part number, insert A = Option 1, B = Option 2 or C = Option 3. Designates Test Option. See Space Grade Test Methods chart for more information.

Refer to Ordering Information for additional detail.

Table 1 – Ratings & Part Number Reference cont'd

Rated Voltage	Rated Cap	Case Code/ Case Size	KEMET Part Number	DC Leakage	DF	Standard ESR	Low ESR	Moisture Sensitivity
V	µF	KEMET/EIA	(See below for part options)	µA @ +20°C Maximum/5 Min	% @ +20°C 120 Hz Maximum	Ω @ +20°C 100 kHz Maximum	Ω @ +20°C 100 kHz Maximum	Temperature ≤ 260°C
50	0.33	B/1505	T497B334(1)050(2)(3)(4)(5)(6)	1	6	12	4.8	1
50	0.47	C/2005	T497C474(1)050(2)(3)(4)(5)(6)	1	6	8	3.2	1
50	0.68	D/1510	T497D684(1)050(2)(3)(4)(5)(6)	1	6	7	2.3	1
50	1	E/2010	T497E105(1)050(2)(3)(4)(5)(6)	1	6	6	1.7	1
50	1.5	F/2214	T497F155(1)050(2)(3)(4)(5)(6)	1	6	4	1.1	1
50	2.2	F/2214	T497F225(1)050(2)(3)(4)(5)(6)	2	6	2.5	0.7	1
50	3.3	G/2711	T497G335(1)050(2)(3)(4)(5)(6)	2	6	2	0.5	1
50	4.7	H/2915	T497H475(1)050(2)(3)(4)(5)(6)	3	6	1.5	0.5	1
V	µF	KEMET/EIA	(See below for part options)	µA @ +20°C Maximum/5 Min	% @ +20°C 120 Hz Maximum	Ω @ +20°C 100 kHz Maximum	Ω @ +20°C 100 kHz Maximum	Temperature ≤ 260°C
Rated Voltage	Rated Cap	Case Code/ Case Size	KEMET Part Number	DC Leakage	DF	Standard ESR	Low ESR	Moisture Sensitivity

(1) To complete KEMET part number, insert M for ± 20%, K for ± 10%. Designates Capacitance tolerance.

(2) To complete KEMET part number, insert C (0.01%/1000Hrs). Designates Reliability Level.

(3) To complete KEMET part number, insert C = Hot Solder Dipped, B = Gold Plated, H = Solder Plated, or T = 100% Tin (Sn). Designates Termination Finish.

(4) To complete KEMET part number, insert 61 = None, 62 = 10 cycles +25°C, 63 = 10 cycles -55°C +85°C after Weibull, 64 = 10 cycles -55°C +85°C before Weibull or 65 = Both. Designates Surge current option.

(5) To complete KEMET part number, insert 1 = Standard ESR, 2 = Low ESR. Designates ESR option.

(6) To complete KEMET part number, insert A = Option 1, B = Option 2 or C = Option 3. Designates Test Option. See Space Grade Test Methods chart for more information.

Refer to Ordering Information for additional detail.

Recommended Voltage Derating Guidelines

	-55°C to 85°C	85°C to 125°C
% Change in Working DC Voltage with Temperature	V_R	67% of V_R
Recommended Maximum Application Voltage	50% of V_R	33% of V_R

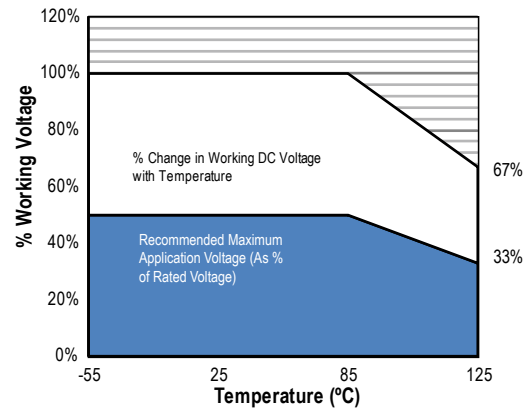

Ripple Current/Ripple Voltage

Permissible AC ripple voltage and current are related to equivalent series resistance (ESR) and the power dissipation capabilities of the device. Permissible AC ripple voltage which may be applied is limited by two criteria:

1. The positive peak AC voltage plus the DC bias voltage, if any, must not exceed the DC voltage rating of the capacitor.
2. The negative peak AC voltage in combination with bias voltage, if any, must not exceed the allowable limits specified for reverse voltage. See the Reverse Voltage section for allowable limits.

The maximum power dissipation by case size can be determined using the table at right. The maximum power dissipation rating stated in the table must be reduced with increasing environmental operating temperatures. Refer to the table below for temperature compensation requirements.

KEMET Case Code	EIA Case Code	Maximum Power Dissipation (P max) mWatts @ 25°C w/+20°C Rise
A	1005	50
B	1505	70
C	2005	75
D	1510	80
E	2010	90
F	2214	100
G	2711	125
H	2915	150

The maximum power dissipation rating must be reduced with increasing environmental operating temperatures. Refer to the Temperature Compensation Multiplier table for details.

Temperature Compensation Multipliers for Maximum Ripple Current		
T ≤ 25°C	T ≤ 85°C	T ≤ 125°C
1.00	0.90	0.40

T = Environmental Temperature

Using the P max of the device, the maximum allowable rms ripple current or voltage may be determined.

$$I(max) = \sqrt{P_{max}/R}$$

$$E(max) = Z \sqrt{P_{max}/R}$$

I = rms ripple current (amperes)

E = rms ripple voltage (volts)

P max = maximum power dissipation (watts)

R = ESR at specified frequency (ohms)

Z = Impedance at specified frequency (ohms)

Reverse Voltage

Solid tantalum capacitors are polar devices and may be permanently damaged or destroyed if connected with the wrong polarity. The positive terminal is identified on the capacitor body by a stripe plus in some cases a beveled edge. A small degree of transient reverse voltage is permissible for short periods per the table. The capacitors should not be operated continuously in reverse mode, even within these limits.

Temperature	Permissible Transient Reverse Voltage
25°C	15% of Rated Voltage
85°C	5% of Rated Voltage
125°C	1% of Rated Voltage

Table 2 – Land Dimensions/Courtyard

KEMET Case	Metric Size Code EIA	Density Level A: Maximum (Most) Land Protrusion (mm)					Density Level B: Median (Nominal) Land Protrusion (mm)					Density Level C: Minimum (Least) Land Protrusion (mm)				
		W	L	S	V1	V2	W	L	S	V1	V2	W	L	S	V1	V2
A ¹	1005	1.35	2.20	0.62	6.02	2.80	1.23	1.80	0.82	4.92	2.30	1.13	1.42	0.98	4.06	2.04
B	1505	2.35	2.21	0.92	6.32	4.00	2.23	1.80	1.12	5.22	3.50	2.13	1.42	1.28	4.36	3.24
C	2005	2.35	2.77	2.37	8.92	4.50	2.23	2.37	2.57	7.82	4.00	2.13	1.99	2.73	6.96	3.74
D	1510	2.55	2.77	3.67	10.22	5.60	2.43	2.37	3.87	9.12	5.10	2.33	1.99	4.03	8.26	4.84
E	2010	4.25	2.77	3.67	10.22	7.30	4.13	2.37	3.87	9.12	6.80	4.03	1.99	4.03	8.26	6.54
F	2214	2.30	3.47	2.98	8.58	4.82	1.90	3.35	3.18	7.48	4.32	1.52	3.25	3.34	6.62	4.06
G	2711	2.81	2.84	3.10	9.72	4.18	2.41	2.72	3.30	8.62	3.68	2.03	2.62	3.46	7.76	3.42
H	2915	2.81	3.84	3.61	10.24	5.20	2.41	3.72	3.81	9.14	4.70	2.03	3.62	3.97	8.28	4.44
X	2824	2.73	3.22	3.46	9.92	6.80	2.33	3.10	3.66	8.82	6.30	1.95	3.00	3.82	7.96	6.04

Density Level A: For low-density Product applications. Recommended for wave solder applications and provides a wider process window for reflow solder processes.

Density Level B: For products with a moderate level of component density. Provides a robust solder attachment condition for reflow solder processes.

Density Level C: For high component density product applications. Before adapting the minimum land pattern variations the user should perform qualification testing based on the conditions outlined in IPC Standard 7351 (IPC-7351).

¹ Land pattern geometry is too small for silkscreen outline.

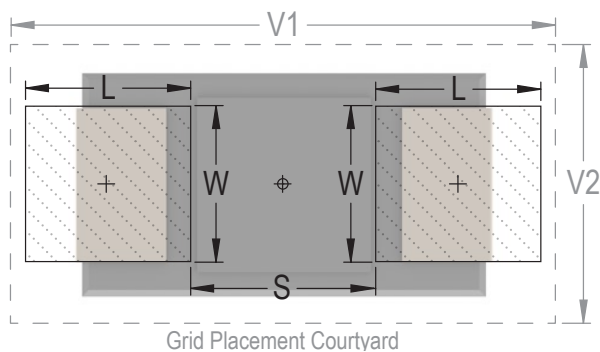

Soldering Process

KEMET's families of surface mount capacitors are compatible with wave (single or dual), convection, IR, or vapor phase reflow techniques. Preheating of these components is recommended to avoid extreme thermal stress. KEMET's recommended profile conditions for convection and IR reflow reflect the profile conditions of the IPC/J-STD-020D standard for moisture sensitivity testing. The devices can safely withstand a maximum of three reflow passes at these conditions.

Please note that although the X/7343-43 case size can withstand wave soldering, the tall profile (4.3 mm maximum) dictates care in wave process development.

Hand soldering should be performed with care due to the difficulty in process control. If performed, care should be taken to avoid contact of the soldering iron to the molded case. The iron should be used to heat the solder pad, applying solder between the pad and the termination, until reflow occurs. Once reflow occurs, the iron should be removed immediately. "Wiping" the edges of a chip and heating the top surface is not recommended.

During typical reflow operations, a slight darkening of the gold-colored epoxy may be observed. This slight darkening is normal and not harmful to the product. Marking permanency is not affected by this change.

Profile Feature	SnPb Assembly	Pb-Free Assembly
Preheat/Soak		
Temperature Minimum (T_{smin})	100°C	150°C
Temperature Maximum (T_{smax})	150°C	200°C
Time (t_s) from T_{smin} to T_{smax}	60 – 120 seconds	60 – 120 seconds
Ramp-up Rate (T_i to T_p)	3°C/seconds maximum	3°C/seconds maximum
Liquidous Temperature (T_L)	183°C	217°C
Time Above Liquidous (t_L)	60 – 150 seconds	60 – 150 seconds
Peak Temperature (T_p)	220°C* 235°C**	250°C* 260°C**
Time within 5°C of Maximum Peak Temperature (t_p)	20 seconds maximum	30 seconds maximum
Ramp-down Rate (T_p to T_L)	6°C/seconds maximum	6°C/seconds maximum
Time 25°C to Peak Temperature	6 minutes maximum	8 minutes maximum

Note: All temperatures refer to the center of the package, measured on the package body surface that is facing up during assembly reflow.

*Case Size D, E, P, Y, and X

**Case Size A, B, C, H, I, K, M, R, S, T, U, V, W, and Z

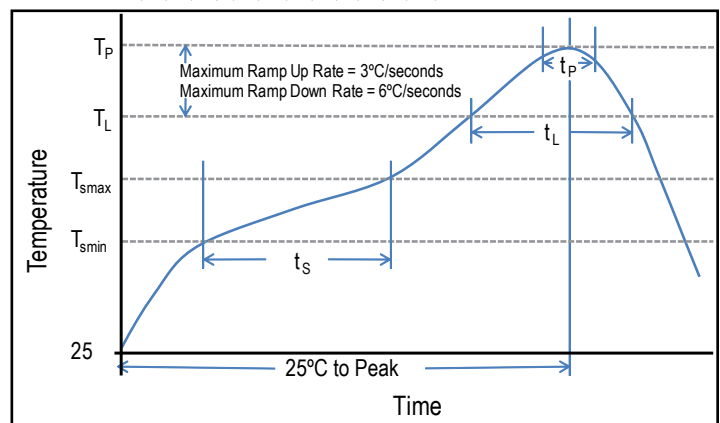

Storage

Tantalum chip capacitors should be stored in normal working environments. While the chips themselves are quite robust in other environments, solderability will be degraded by exposure to high temperatures, high humidity, corrosive atmospheres, and long term storage. In addition, packaging materials will be degraded by high temperature— reels may soften or warp and tape peel force may increase. KEMET recommends that maximum storage temperature not exceed 40°C and maximum storage humidity not exceed 60% relative humidity. Temperature fluctuations should be minimized to avoid condensation on the parts and atmospheres should be free of chlorine and sulphur bearing compounds. For optimized solderability chip stock should be used promptly, preferably within three years of receipt.

Construction

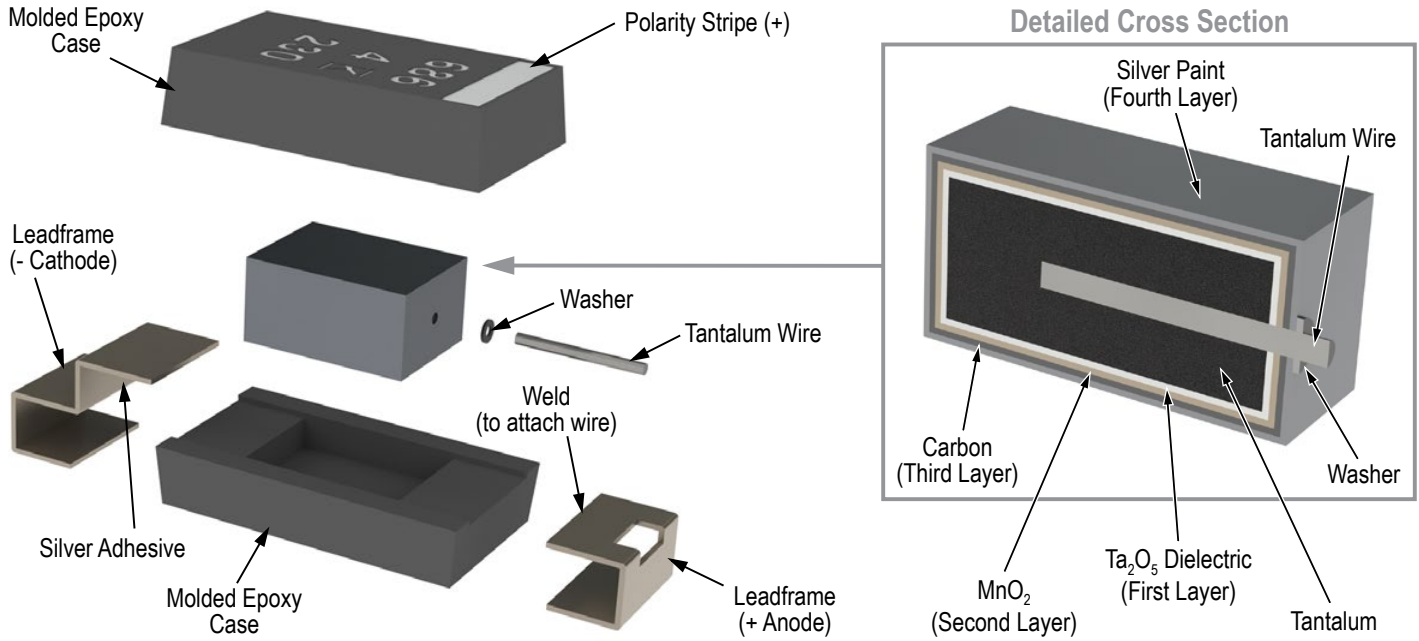

Capacitor Marking

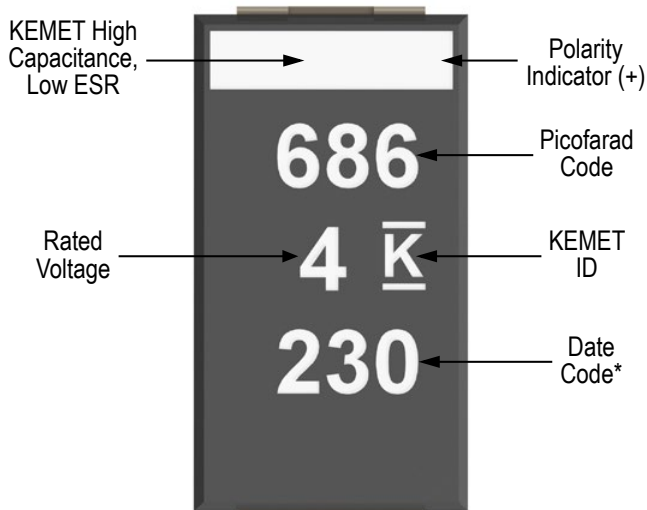

* 230 = 30th week of 2012

Date Code *	
1 st digit = Last number of Year	9 = 2009 0 = 2010 1 = 2011 2 = 2012 3 = 2013 4 = 2014
2 nd and 3 rd digit = Week of the Year	01 = 1 st week of the Year to 52 = 52 nd week of the Year

Overview

KEMET's Space Grade Series of capacitors are suitable for use by defense/aerospace customers in high reliability space applications. This series meets the requirements of MIL-PRF-55365 as well as MIL-STD-1580. These capacitors incorporate an intensive testing and screening protocol which is customizable depending upon customer's specific needs. The full part number allows for designation of Weibull grading level

(B=0.1%/k hours or C=0.01%/k hours), surge current level (10 cycles -55°C and +85°C before and/or after Weibull grading), performance testing level (see chart for details on available options), ESR (low and standard), and termination finish (see description in each series). Fused versions are available for built-in circuit protection, as well as multi-anode designs for very low ESR values.

Benefits

- ESR as low as 18 mΩ
- High ripple current capability
- RoHS Compliant and lead-free terminations
- 100% steady-state accelerated aging
- 100% surge current test
- Meets or exceeds EIA standard 535BAAC
- Taped and reeled per EIA 481
- Weibull Grading C (0.01%/1,000 hours)
- Operating temperature range of -55°C to +125°C

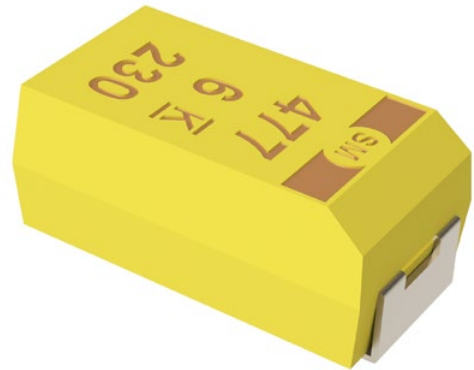

Applications

Typical applications include decoupling and filtering in defense and aerospace end applications, such as DC/DC converters, portable electronics, telecommunications, and control units requiring high ripple current capability.

Environmental Compliance

RoHS Compliant (6/6) according to Directive 2002/95/EC when ordered with 100% Sn solder.



RoHS Compliant

SPICE

For a detailed analysis of specific part numbers, please visit www.kemet.com for a free download of KEMET's SPICE software. The KEMET SPICE program is freeware intended to aid design engineers in analyzing the performance of these capacitors over frequency, temperature, ripple, and DC bias conditions.

Ordering Information

T	510	X	477	M	006	C	T	61	1	A
Capacitor Class	Series	Case Size	Capacitance Code (pF)	Capacitance Tolerance	Voltage	Failure Rate/Design	Lead Material	Surge	ESR	Testing
T = Tantalum	Ultra Low ESR - Space Grade	E, X	First two digits represent significant figures. Third digit specifies number of zeros.	K = ±10% M = ±20%	004 = 4 V 006 = 6.3 V 010 = 10 V	C = 0.01%/1,000 hours	C = Hot Solder Dipped T = 100% Matte Tin (Sn) Plated H = Standard Solder Coated (SnPb 5% Pb minimum)	61 = None 62 = 10 Cycles after Weibull, 25°C 63 = 10 Cycles, after Weibull, -55°C and 85°C 64 = 10 Cycles before Weibull, -55°C and 85°C 65 = 10 Cycles Before and After Weibull, -55°C and 85°C	1 = ESR - Standard	A = Option A B = Option B C = Option C

Performance Characteristics

Item	Performance Characteristics
Operating Temperature	-55°C to 125°C
Rated Capacitance Range	10 – 1,000 µF @ 120 Hz/25°C
Capacitance Tolerance	K Tolerance (10%), M Tolerance (20%)
Rated Voltage Range	4 – 10 V
DF (120 Hz)	Refer to Part Number Electrical Specification Table
ESR (100 kHz)	Refer to Part Number Electrical Specification Table
Leakage Current	≤ 0.01 CV (µA) at rated voltage after 5 minutes

Qualification

Test	Condition	Characteristics				
Endurance	85°C @ rated voltage, 2,000 hours 125°C @ 2/3 rated voltage, 2,000 hours	Δ C/C	Within ±10% of initial value			
		DF	Within initial limits			
		DCL	Within 1.25 x initial limit			
		ESR	Within initial limits			
Storage Life	125°C @ 0 volts, 2,000 hours	Δ C/C	Within ±10% of initial value			
		DF	Within initial limits			
		DCL	Within 1.25 x initial limit			
		ESR	Within initial limits			
Thermal Shock	MIL-STD-202, Method 107, Condition B, mounted, -55°C to 125°C, 1,000 cycles	Δ C/C	Within ±5% of initial value			
		DF	Within initial limits			
		DCL	Within 1.25 x initial limit			
		ESR	Within initial limits			
Temperature Stability	Extreme temperature exposure at a succession of continuous steps at +25°C, -55°C, +25°C, +85°C, +125°C, +25°C		+25°C	-55°C	+85°C	+125°C
		Δ C/C	IL*	±10%	±10%	±20%
		DF	IL	IL	1.5 x IL	1.5 x IL
		DCL	IL	n/a	10 x IL	12 x IL
Surge Voltage	25°C and 85°C, 1.32 x rated voltage 1,000 cycles. (125°C, 1.2 x rated voltage)	Δ C/C	Within ±5% of initial value			
		DF	Within initial limits			
		DCL	Within initial limits			
		ESR	Within initial limits			
Mechanical Shock/Vibration	MIL-STD-202, Method 213, Condition I, 100 G peak. MIL-STD-202, Method 204, Condition D, 10 Hz to 2,000 Hz, 20 G peak	Δ C/C	Within ±10% of initial value			
		DF	Within initial limits			
		DCL	Within initial limits			

*IL = Initial limit

Test Methods

Test Sequence	Test Method	Option A	Option B	Option C
100% Serialization	KEMET Standard			X
100% IR Reflow	MIL-PRF-55365	X	X	X
100% Thermal Shock	MIL-PRF-55365	X	X	X
100% Electrical Verification	KEMET Standard	X		X
Read and Record Attributes/Variables Data	KEMET Standard			X
100% Surge Current, Option C with 5% PDA Calculation	MIL-PRF-55365 with 5% PDA Calculation	X	X	X
100% Electrical Verification	KEMET Standard		X	X
Read and Record Attributes/Variables Data	KEMET Standard			X
100% Voltage Aging, 10 hours @1.32 Vr	MIL-PRF-55365		X	X
100% Electrical Verification	KEMET Standard		X	X
100% Weibull Grading B or C	MIL-PRF-55365	X	X	X
100% Electrical Verification	KEMET Standard	X	X	X
Read and Record Attributes/Variables Data	KEMET Standard			X
100% Surge Current, Option A or B with 5% PDA Calculation	MIL-PRF-55365 with 5% PDA Calculation	X	X	X
100% Electrical Verification	KEMET Standard	X	X	X
Read and Record Attributes/Variables Data	KEMET Standard			X
3 Sigma Screening - All Electricals	KEMET Standard	X	X	X
Read and Record Attributes/Variables Data	KEMET Standard			X
Destructive Physical Analysis (DPA) (5 pieces- each lot)	MIL-PRF-55365	X	X	X
Group B Testing (22 pieces - each lot)	* See Note Below		X	X
Temperature Stability - sample	MIL-PRF-55365	X	X	X
Solderability - Sample	MIL-PRF-55365	X	X	X
Group C Testing (57 pieces - each Lot)**	MIL-PRF-55365		X	X
100% X-ray	MIL-PRF-55365	X		
100% X-ray - 2 Plane***	MIL-PRF-55365 and KEMET Standard		X	X
100% Physical Dimension Verification	MIL-PRF-55365	X	X	X
Data Pack				
Group A and C Summaries			X	X
2 Plane X-ray JPEG photos			X	X
DPA Report			X	X
Attributes/Variables Data for Cap/Df/DCL/ESR				X

X = Included in test option

* Group B Testing = 10,000 Cycles Surge Current, 85°C, 40% Vr

** Group C Post Moisture ESR limit = 1.25 initial limit

*** 2 Plane X-ray = Top and side views, molded case wall thickness minimum 0.005" on all sides, negative/positive termination attachment criteria per MIL-STD-1580

Electrical Characteristics

Impedance, ESR vs. Frequency

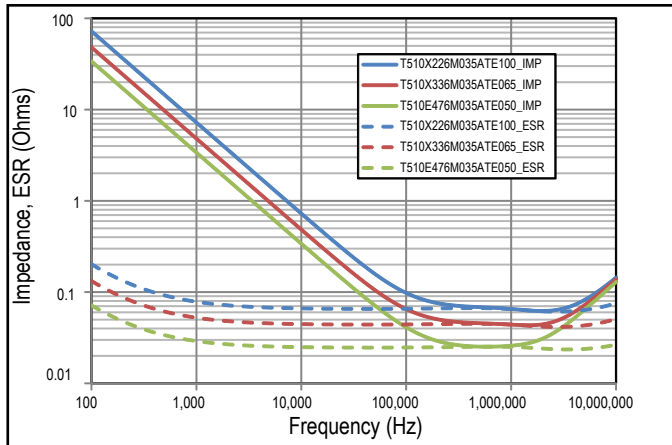

Capacitance vs. Frequency

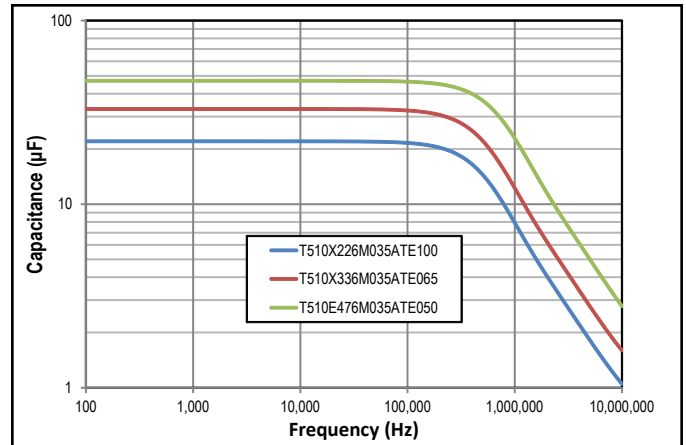

Dimensions – Millimeters (Inches)

Metric will govern

CATHODE (-) END VIEW

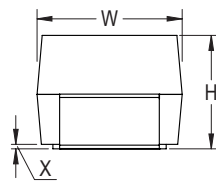

SIDE VIEW

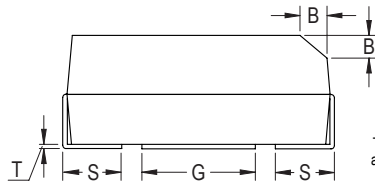

ANODE (+) END VIEW

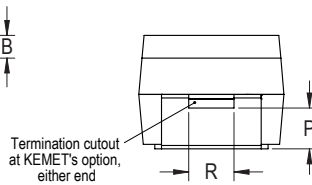

BOTTOM VIEW

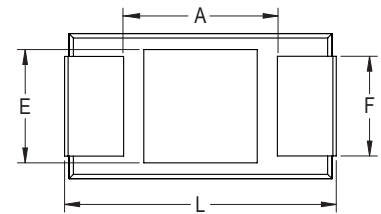

Case Size		Component												
KEMET	EIA	L*	W*	H*	F* ±0.1 ±(.004)	S* ±0.3 ±(.012)	B* ±0.15 (Ref) ±.006	X (Ref)	P (Ref)	R (Ref)	T (Ref)	A (Min)	G (Ref)	E (Ref)
X	7343-43	7.3 ±0.3 (0.287 ±0.012)	4.3 ±0.3 (0.169 ±0.012)	4.0 ±0.3 (0.157 ±0.012)	2.4 (.094)	1.3 (.051)	0.5 (.020)	0.10 ± 0.10 (.004 ± .004)	1.7 (.067)	1.0 (.039)	0.13 (.005)	3.8 (.150)	3.5 (.138)	3.5 (.138)
E	7360-38	7.3 ±0.3 (0.287 ±0.012)	6.0 ±0.3 (0.236 ±0.012)	3.6 ±0.2 (0.142 ±0.008)	4.1 (.161)	1.3 (.051)	0.5 (.020)	0.10 ± 0.10 (.004 ± .004)	n/a	n/a	0.13 (.005)	3.8 (.150)	3.5 (.138)	3.5 (.138)

Notes: (Ref) – Dimensions provided for reference only. No dimensions are provided for B, P or R because low profile cases do not have a bevel or a notch.

* MIL-C-55365/8 specified dimensions

Table 1 – Ratings & Part Number Reference

Rated Voltage	Rated Cap	Case Code/ Case Size	KEMET Part Number	DC Leakage	DF	ESR	Maximum Allowable Ripple Current			Moisture Sensitivity
							(mA) 100 kHz +25°C	(mA) 100 kHz +85°C	(mA) 100 kHz +125°C	
V	μF	KEMET/EIA	(See below for part options)	μA @ +20°C Maximum/5 Min	% @ +20°C 120 Hz Maximum	mΩ @ +20°C 100 kHz Maximum				Temperature ≤ 260°C
4	1000	X/7343-43	T510X108(1)004C(2)(3)1(4)	40	6	18	3.9	3.5	1.5	1
6.3	680	E/7360-38	T510E687(1)006C(2)(3)1(4)	40.8	6	23	3.5	3.2	1.4	1
10	330	X/7343-43	T510X337(1)010C(2)(3)1(4)	33	6	35	2.8	2.5	1.1	1

(1) To complete KEMET part number, insert M for ±20%, K for ±10%. Designates Capacitance tolerance.

(2) To complete KEMET part number, insert C = Hot Solder Dipped, H = Solder Plated or T = 100% Tin (Sn). Designates Termination Finish.

(3) To complete KEMET part number, insert 61 = None, 62 = 10 cycles +25°C, 63 = 10 cycles -55°C +85°C after Weibull, 64 = 10 cycles -55°C +85°C before Weibull or 65 = Both. Designates Surge current option.

(4) To complete KEMET part number, insert A = Option 1, B = Option 2 or C = Option 3. Designates Test Option. See Space Grade Test Methods chart for more information.

(Refer to Ordering Information for additional detail.)

Recommended Voltage Derating Guidelines

	-55°C to 85°C	85°C to 125°C
% Change in Working DC Voltage with Temperature	V _R	67% of V _R
Recommended Maximum Application Voltage	50% of V _R	33% of V _R

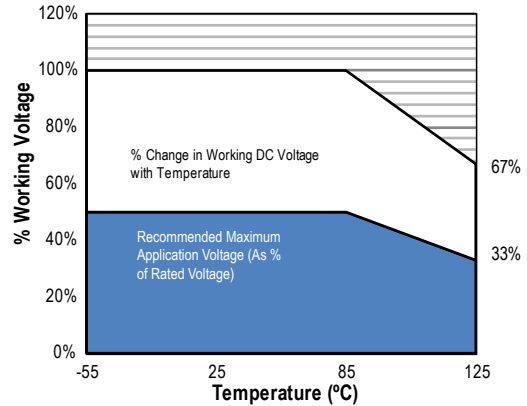

Ripple Current/Ripple Voltage

Permissible AC ripple voltage and current are related to equivalent series resistance (ESR) and the power dissipation capabilities of the device. Permissible AC ripple voltage which may be applied is limited by two criteria:

1. The positive peak AC voltage plus the DC bias voltage, if any, must not exceed the DC voltage rating of the capacitor.
2. The negative peak AC voltage in combination with bias voltage, if any, must not exceed the allowable limits specified for reverse voltage. See the Reverse Voltage section for allowable limits.

The maximum power dissipation by case size can be determined using the table at right. The maximum power dissipation rating stated in the table must be reduced with increasing environmental operating temperatures. Refer to the table below for temperature compensation requirements.

KEMET Series and Case Code	EIA Case Code	Maximum Power Dissipation (P max) mWatts @ 25°C w/+20°C Rise
T510X	7343-43	270
T510E	7360-38	285

The maximum power dissipation rating must be reduced with increasing environmental operating temperatures. Refer to the Temperature Compensation Multiplier table for details.

Temperature Compensation Multipliers for Maximum Ripple Current		
T ≤ 25°C	T ≤ 85°C	T ≤ 125°C
1.00	0.90	0.40

T= Environmental Temperature

Using the P max of the device, the maximum allowable rms ripple current or voltage may be determined.

$$I(max) = \sqrt{P_{max}/R}$$

$$E(max) = Z \sqrt{P_{max}/R}$$

I = rms ripple current (amperes)

R = ESR at specified frequency (ohms)

E = rms ripple voltage (volts)

Z = Impedance at specified frequency (ohms)

P max = maximum power dissipation (watts)

Reverse Voltage

Solid tantalum capacitors are polar devices and may be permanently damaged or destroyed if connected with the wrong polarity. The positive terminal is identified on the capacitor body by a stripe plus in some cases a beveled edge. A small degree of transient reverse voltage is permissible for short periods per the table. The capacitors should not be operated continuously in reverse mode, even within these limits.

Temperature	Permissible Transient Reverse Voltage
25°C	15% of Rated Voltage
85°C	5% of Rated Voltage
125°C	1% of Rated Voltage

Table 2 – Land Dimensions/Courtyard

KEMET	Metric Size Code	Density Level A: Maximum (Most) Land Protrusion (mm)					Density Level B: Median (Nominal) Land Protrusion (mm)					Density Level C: Minimum (Least) Land Protrusion (mm)						
		Case	EIA	W	L	S	V1	V2	W	L	S	V1	V2	W	L	S	V1	V2
E ¹	7360-38	4.25	2.77	3.67	10.22	7.30	4.13	2.37	3.87	9.12	6.80	4.03	1.99	4.03	8.26	6.54		
X ¹	7343-43	2.55	2.77	3.67	10.22	5.60	2.43	2.37	3.87	9.12	5.10	2.33	1.99	4.03	8.26	4.84		

Density Level A: For low-density product applications. Recommended for wave solder applications and provides a wider process window for reflow solder processes.

Density Level B: For products with a moderate level of component density. Provides a robust solder attachment condition for reflow solder processes.

Density Level C: For high component density product applications. Before adapting the minimum land pattern variations the user should perform qualification testing based on the conditions outlined in IPC Standard 7351 (IPC-7351).

¹ Height of these chips may create problems in wave soldering.

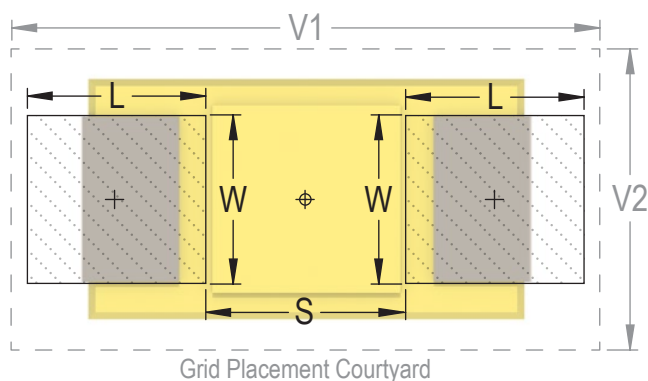

Soldering Process

KEMET's families of surface mount capacitors are compatible with wave (single or dual), convection, IR, or vapor phase reflow techniques. Preheating of these components is recommended to avoid extreme thermal stress. KEMET's recommended profile conditions for convection and IR reflow reflect the profile conditions of the IPC/J-STD-020D standard for moisture sensitivity testing. The devices can safely withstand a maximum of three reflow passes at these conditions.

Please note that although the X/7343-43 case size can withstand wave soldering, the tall profile (4.3 mm maximum) dictates care in wave process development.

Hand soldering should be performed with care due to the difficulty in process control. If performed, care should be taken to avoid contact of the soldering iron to the molded case. The iron should be used to heat the solder pad, applying solder between the pad and the termination, until reflow occurs. Once reflow occurs, the iron should be removed immediately. "Wiping" the edges of a chip and heating the top surface is not recommended.

During typical reflow operations, a slight darkening of the gold-colored epoxy may be observed. This slight darkening is normal and not harmful to the product. Marking permanency is not affected by this change.

Profile Feature	SnPb Assembly	Pb-Free Assembly
Preheat/Soak		
Temperature Minimum (T_{smin})	100°C	150°C
Temperature Maximum (T_{smax})	150°C	200°C
Time (t_s) from T_{smin} to T_{smax}	60 – 120 seconds	60 – 120 seconds
Ramp-up Rate (T_L to T_p)	3°C/seconds maximum	3°C/seconds maximum
Liquidous Temperature (T_L)	183°C	217°C
Time Above Liquidous (t_L)	60 – 150 seconds	60 – 150 seconds
Peak Temperature (T_p)	220°C* 235°C**	250°C* 260°C**
Time within 5°C of Maximum Peak Temperature (t_p)	20 seconds maximum	30 seconds maximum
Ramp-down Rate (T_p to T_L)	6°C/seconds maximum	6°C/seconds maximum
Time 25°C to Peak Temperature	6 minutes maximum	8 minutes maximum

Note: All temperatures refer to the center of the package, measured on the package body surface that is facing up during assembly reflow.

*Case Size D, E, P, Y, and X

**Case Size A, B, C, H, I, K, M, R, S, T, U, V, W, and Z

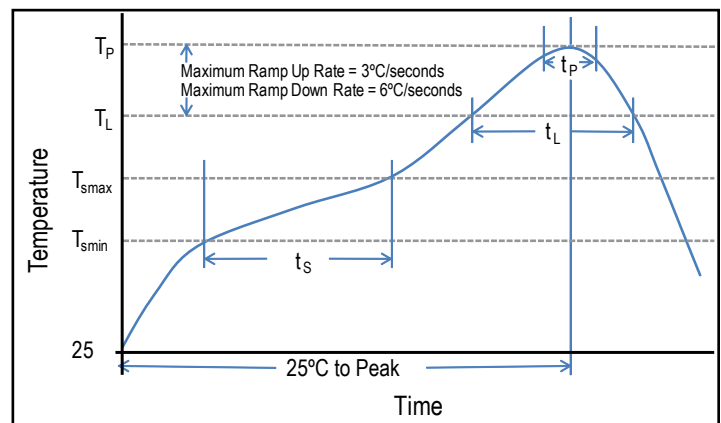

Storage

Tantalum chip capacitors should be stored in normal working environments. While the chips themselves are quite robust in other environments, solderability will be degraded by exposure to high temperatures, high humidity, corrosive atmospheres, and long term storage. In addition, packaging materials will be degraded by high temperature—reels may soften or warp and tape peel force may increase. KEMET recommends that maximum storage temperature not exceed 40°C and maximum storage humidity not exceed 60% relative humidity. Temperature fluctuations should be minimized to avoid condensation on the parts and atmospheres should be free of chlorine and sulphur bearing compounds. For optimized solderability chip stock should be used promptly, preferably within three years of receipt.

Construction

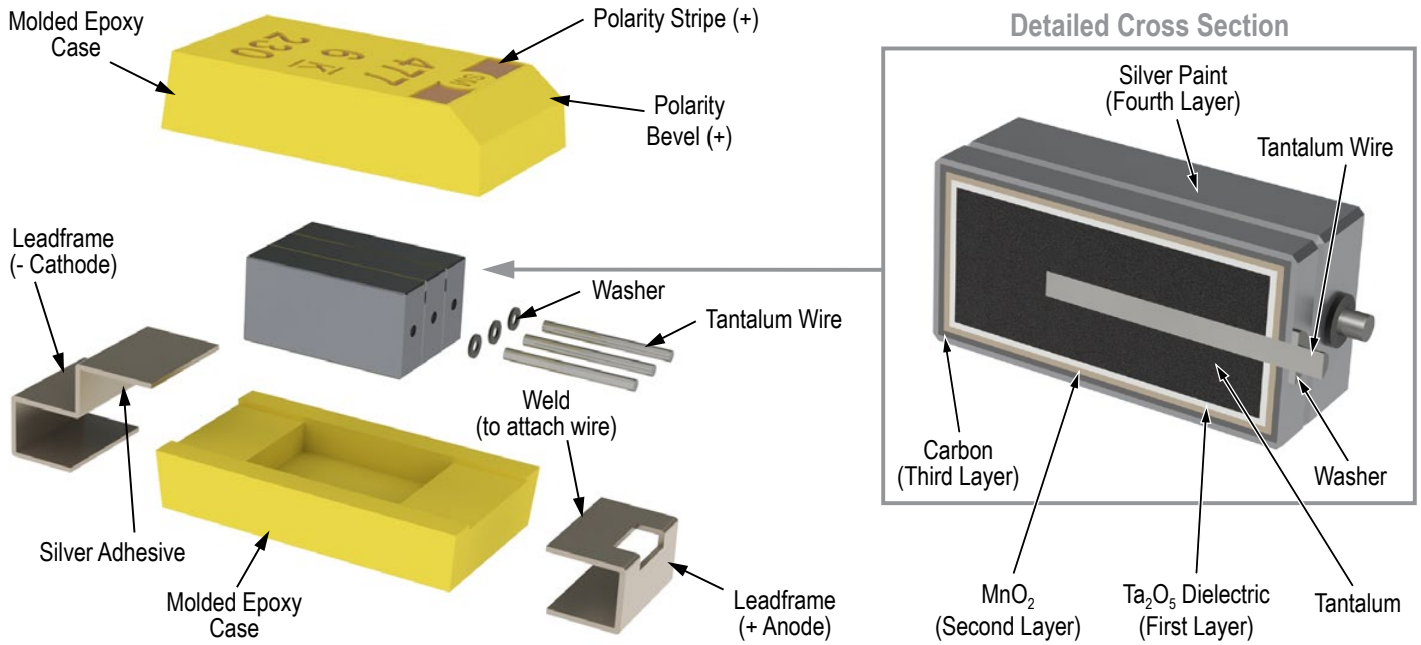

Capacitor Marking

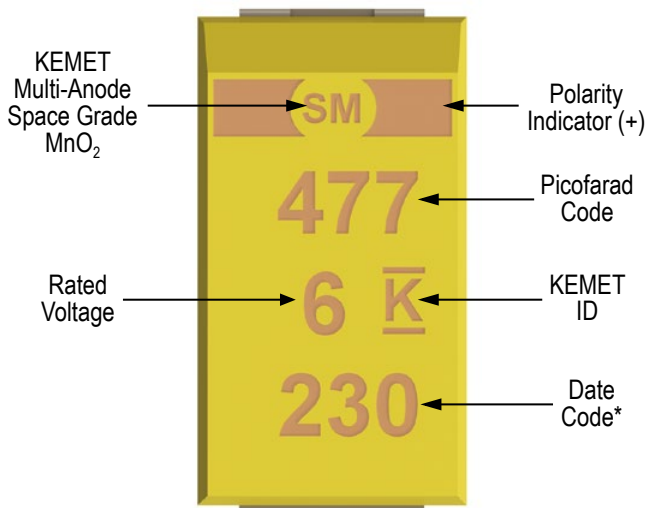

* 230 = 30th week of 2012

Date Code *	
1 st digit = Last number of Year	9 = 2009 0 = 2010 1 = 2011 2 = 2012 3 = 2013 4 = 2014
2 nd and 3 rd digit = Week of the Year	01 = 1 st week of the Year to 52 = 52 nd week of the Year

Tape & Reel Packaging Information

KEMET's molded tantalum and aluminum chip capacitor families are packaged in 8 and 12 mm plastic tape on 7" and 13" reels in accordance with *EIA Standard 481: Embossed Carrier Taping of Surface Mount Components for Automatic Handling*. This packaging system is compatible with all tape-fed automatic pick-and-place systems.

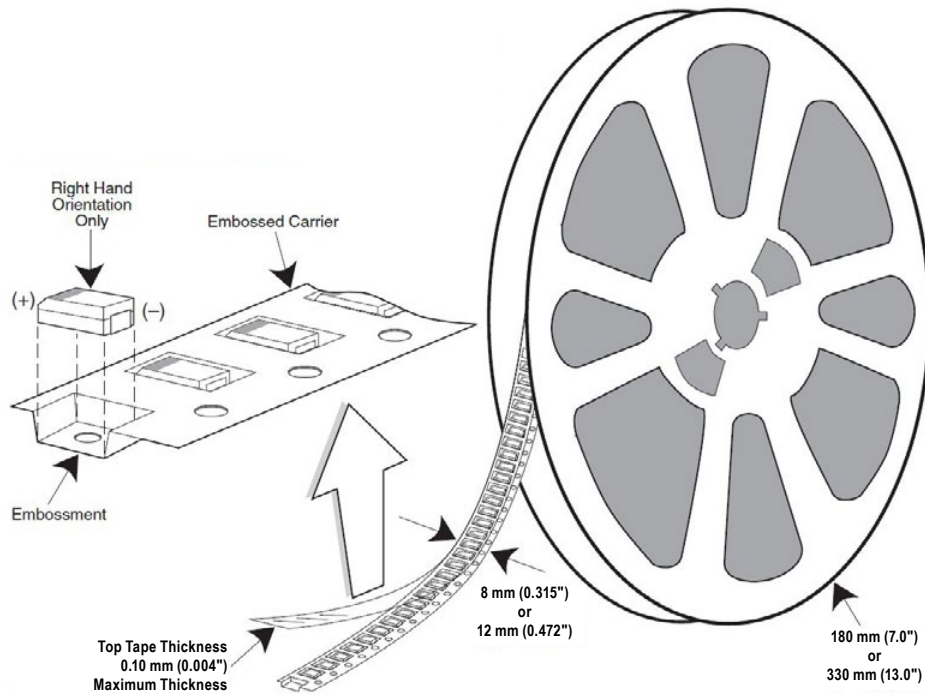

Table 3 – Packaging Quantity

Case Code		Tape Width (mm)	7" Reel*	13" Reel*
KEMET	EIA			
S	3216-12	8	2,500	10,000
T	3528-12	8	2,500	10,000
M	3528-15	8	2,000	8,000
U	6032-15	12	1,000	5,000
L	6032-19	12	1,000	5,000
W	7343-15	12	1,000	3,000
Z	7343-17	12	1,000	3,000
V	7343-20	12	1,000	3,000
A	3216-18	8	2,000	9,000
B	3528-21	8	2,000	8,000
C	6032-28	12	500	3,000
D	7343-31	12	500	2,500
Q	7343-12	12	1,000	3,000
Y	7343-40	12	500	2,000
X	7343-43	12	500	2,000
E/T428P	7360-38	12	500	2,000
H	7360-20	12	1,000	2,500

* No C-Spec required for 7" reel packaging. C-7280 required for 13" reel packaging.

Figure 1 – Embossed (Plastic) Carrier Tape Dimensions

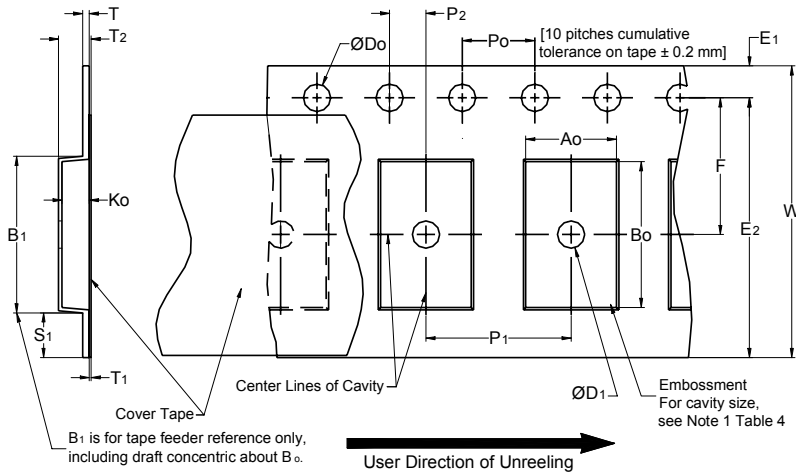

Table 4 – Embossed (Plastic) Carrier Tape Dimensions

Metric will govern

Constant Dimensions — Millimeters (Inches)									
Tape Size	D ₀	D ₁ Minimum Note 1	E ₁	P ₀	P ₂	R Reference Note 2	S ₁ Minimum Note 3	T Maximum	T ₁ Maximum
8 mm	1.5 +0.10/-0.0 (0.059 +0.004/-0.0)	1.0 (0.039)	1.75 ±0.10 (0.069 ±0.004)	4.0 ±0.10 (0.157 ±0.004)	2.0 ±0.05 (0.079 ±0.002)	25.0 (0.984)	0.600 (0.024)	0.600 (0.024)	0.100 (0.004)
12 mm		1.5 (0.059)			2.0 ±0.1 (0.079 ±0.059)				
16 mm									
Variable Dimensions — Millimeters (Inches)									
Tape Size	Pitch	B ₁ Maximum Note 4	E ₂ Minimum	F	P ₁	T ₂ Maximum	W Maximum	A ₀ , B ₀ & K ₀	
8 mm	Single (4 mm)	4.35 (0.171)	6.25 (0.246)	3.5 ±0.05 (0.138 ±0.002)	2.0 ±0.05 or 4.0 ±0.10 (0.079 ±0.002 or 0.157 ±0.004)	2.5 (0.098)	8.3 (0.327)	Note 5	
12 mm	Single (4 mm) & Double (8 mm)	8.2 (0.323)	10.25 (0.404)	5.5 ±0.05 (0.217 ±0.002)	2.0 ±0.05 (0.079 ±0.002) or 4.0 ±0.10 (0.157 ±0.004) or 8.0 ±0.10 (0.315 ±0.004)	4.6 (0.181)	12.3 (0.484)		
16 mm	Triple (12 mm)	12.1 (0.476)	14.25 (0.561)	7.5 ±0.10 (0.295 ±0.004)	4.0 ±0.10 (0.157 ±0.004) to 12.0 ±0.10 (0.472 ±0.004)	8.0 (0.315)	16.3 (0.642)		

- The embossment hole location shall be measured from the sprocket hole controlling the location of the embossment. Dimensions of embossment location and hole location shall be applied independent of each other.
- The tape, with or without components, shall pass around R without damage (see Figure 4).
- If S₁ < 1.0 mm, there may not be enough area for cover tape to be properly applied (see EIA Standard 481–D, paragraph 4.3, section b).
- B₁ dimension is a reference dimension for tape feeder clearance only.
- The cavity defined by A₀, B₀ and K₀ shall surround the component with sufficient clearance that:
 - the component does not protrude above the top surface of the carrier tape.
 - the component can be removed from the cavity in a vertical direction without mechanical restriction, after the top cover tape has been removed.
 - rotation of the component is limited to 20° maximum for 8 and 12 mm tapes and 10° maximum for 16 mm tapes (see Figure 2).
 - lateral movement of the component is restricted to 0.5 mm maximum for 8 mm and 12 mm wide tape and to 1.0 mm maximum for 16 mm tape (see Figure 3).
 - see Addendum in EIA Standard 481–D for standards relating to more precise taping requirements.

Packaging Information Performance Notes

- 1. Cover Tape Break Force:** 1.0 Kg minimum.
- 2. Cover Tape Peel Strength:** The total peel strength of the cover tape from the carrier tape shall be:

Tape Width	Peel Strength
8 mm	0.1 to 1.0 Newton (10 to 100 gf)
12 and 16 mm	0.1 to 1.3 Newton (10 to 130 gf)

The direction of the pull shall be opposite the direction of the carrier tape travel. The pull angle of the carrier tape shall be 165° to 180° from the plane of the carrier tape. During peeling, the carrier and/or cover tape shall be pulled at a velocity of 300 ±10 mm/minute.

- 3. Labeling:** Bar code labeling (standard or custom) shall be on the side of the reel opposite the sprocket holes. Refer to EIA Standards 556 and 624.

Figure 2 – Maximum Component Rotation

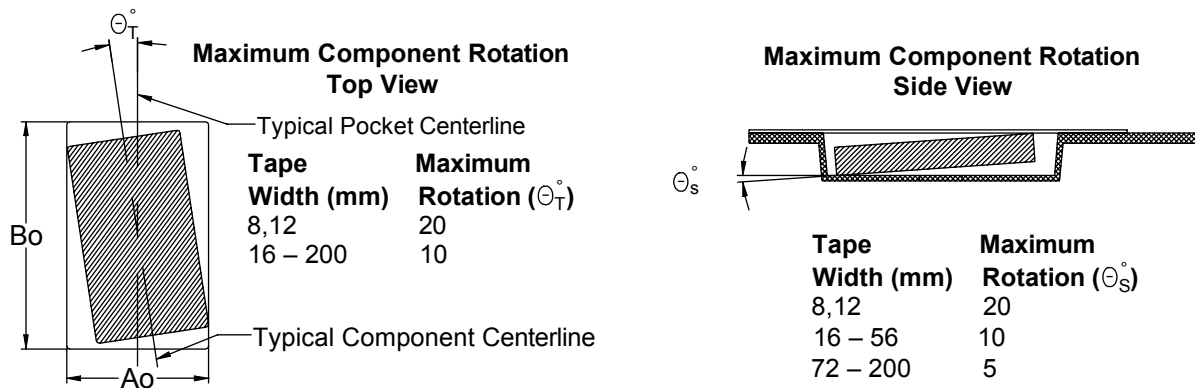

Figure 3 – Maximum Lateral Movement



Figure 4 – Bending Radius

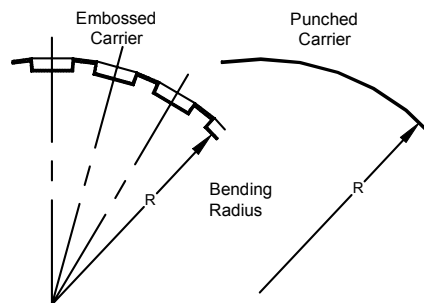

Figure 5 – Reel Dimensions

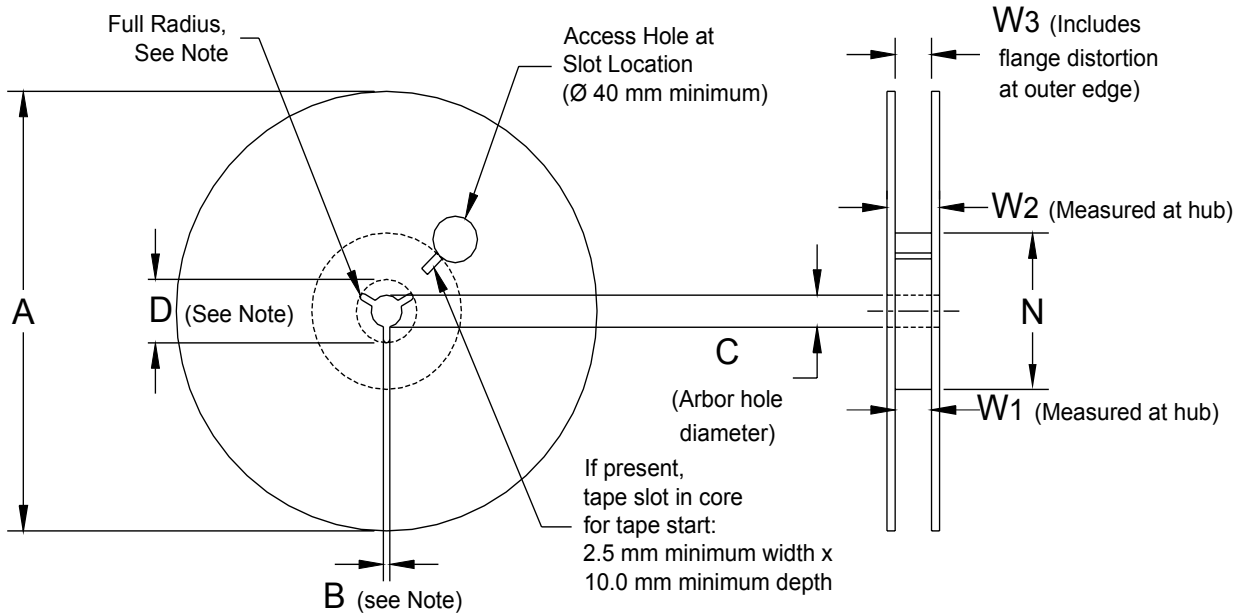

Table 5 – Reel Dimensions

Metric will govern

Constant Dimensions — Millimeters (Inches)				
Tape Size	A	B Minimum	C	D Minimum
8 mm	178 ±0.20 (7.008 ±0.008) or 330 ±0.20 (13.000 ±0.008)	1.5 (0.059)	13.0 +0.5/-0.2 (0.521 +0.02/-0.008)	20.2 (0.795)
12 mm				
16 mm				
Variable Dimensions — Millimeters (Inches)				
Tape Size	N Minimum	W ₁	W ₂ Maximum	W ₃
8 mm	50 (1.969)	8.4 +1.5/-0.0 (0.331 +0.059/-0.0)	14.4 (0.567)	Shall accommodate tape width without interference
12 mm		12.4 +2.0/-0.0 (0.488 +0.078/-0.0)	18.4 (0.724)	
16 mm		16.4 +2.0/-0.0 (0.646 +0.078/-0.0)	22.4 (0.882)	

Figure 6 – Tape Leader & Trailer Dimensions

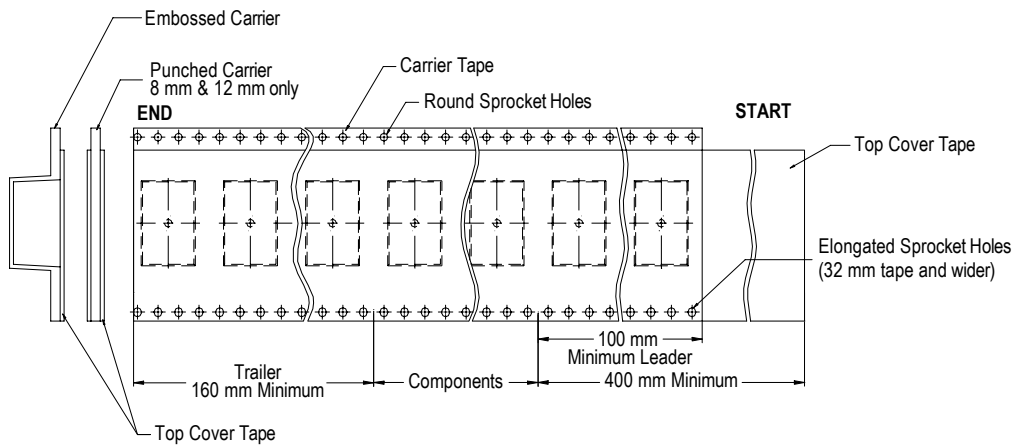
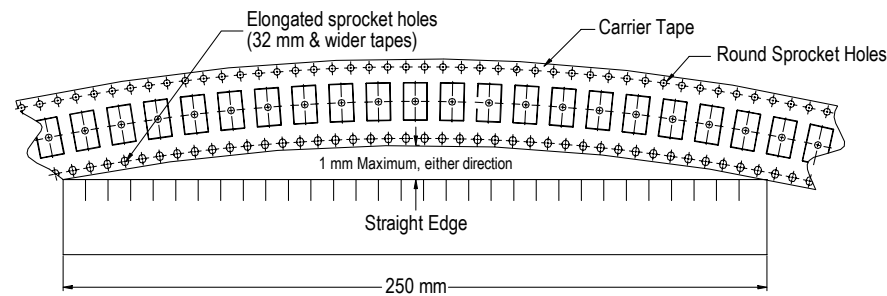

Figure 7 – Maximum Camber



KEMET Corporation World Headquarters

2835 KEMET Way
Simpsonville, SC 29681

Mailing Address:
P.O. Box 5928
Greenville, SC 29606

www.kemet.com
Tel: 864-963-6300
Fax: 864-963-6521

Corporate Offices
Fort Lauderdale, FL
Tel: 954-766-2800

North America

Southeast
Lake Mary, FL
Tel: 407-855-8886

Northeast
Wilmington, MA
Tel: 978-658-1663

Central
Novi, MI
Tel: 248-306-9353

West
Milpitas, CA
Tel: 408-433-9950

Mexico
Guadalajara, Jalisco
Tel: 52-33-3123-2141

Europe

Southern Europe
Paris, France
Tel: 33-1-4646-1006

Sasso Marconi, Italy
Tel: 39-051-939111

Central Europe
Landsberg, Germany
Tel: 49-8191-3350800

Kamen, Germany
Tel: 49-2307-438110

Northern Europe
Bishop's Stortford, United Kingdom
Tel: 44-1279-460122

Espoo, Finland
Tel: 358-9-5406-5000

Asia

Northeast Asia
Hong Kong
Tel: 852-2305-1168

Shenzhen, China
Tel: 86-755-2518-1306

Beijing, China
Tel: 86-10-5829-1711

Shanghai, China
Tel: 86-21-6447-0707

Taipei, Taiwan
Tel: 886-2-27528585

Southeast Asia
Singapore
Tel: 65-6586-1900

Penang, Malaysia
Tel: 60-4-6430200

Bangalore, India
Tel: 91-806-53-76817

Note: KEMET reserves the right to modify minor details of internal and external construction at any time in the interest of product improvement. KEMET does not assume any responsibility for infringement that might result from the use of KEMET Capacitors in potential circuit designs. KEMET is a registered trademark of KEMET Electronics Corporation.

Disclaimer

All product specifications, statements, information and data (collectively, the "Information") in this datasheet are subject to change. The customer is responsible for checking and verifying the extent to which the Information contained in this publication is applicable to an order at the time the order is placed.

All Information given herein is believed to be accurate and reliable, but it is presented without guarantee, warranty, or responsibility of any kind, expressed or implied.

Statements of suitability for certain applications are based on KEMET Electronics Corporation's ("KEMET") knowledge of typical operating conditions for such applications, but are not intended to constitute – and KEMET specifically disclaims – any warranty concerning suitability for a specific customer application or use. The Information is intended for use only by customers who have the requisite experience and capability to determine the correct products for their application. Any technical advice inferred from this Information or otherwise provided by KEMET with reference to the use of KEMET's products is given gratis, and KEMET assumes no obligation or liability for the advice given or results obtained.

Although KEMET designs and manufactures its products to the most stringent quality and safety standards, given the current state of the art, isolated component failures may still occur. Accordingly, customer applications which require a high degree of reliability or safety should employ suitable designs or other safeguards (such as installation of protective circuitry or redundancies) in order to ensure that the failure of an electrical component does not result in a risk of personal injury or property damage.

Although all product-related warnings, cautions and notes must be observed, the customer should not assume that all safety measures are indicated or that other measures may not be required.

Product & Process Design

Sales & Marketing

Supplier

Material Management

Quality

Manufacturing

Logistics & Distribution

People: Leadership
& Development

KEMET Production System

Corporate Office

KEMET Corporation
2835 KEMET Way
Simpsonville, SC 29681
USA

Tel: 864.963.6300

Fax: 864.963.6521

www.kemet.com

One world. One KEMET.

Electronic Components
KEMET
CHARGED®