

Primary lithium battery system BA 5390/U

12 V Primary lithium manganese dioxide (Li-MnO₂) battery

The battery consists of 10 LM 33550 cells connected in 2 groups of 5 cells in series providing 2 nominal 12 V sections at connector. These sections can be connected in series (for 24 V) in parallel (for 12 V), or used as two separate 12 V units.

Key Features

- A non-replaceable fuse is incorporated in the negative leg of each series group of cells
- A normally closed high temperature switch or thermal fuse is incorporated into each series leg of cells
- Internal series string short circuit protection incorporated into each leg of the battery
- A diode is incorporated into the positive leg of each series group of cells to prevent charging or flow of current into the battery
- A device consisting of a manually activated switch and resistors designed to discharge the battery to 0 V is built into the battery (optional)
- Optional design with push button state of charge indicator is available

Typical applications

- AN/PRC-104 Radio
- AN/PRC-113 Radio
- AN/PRC-117 Radio
- AN/PRC-119 Sincgars Radio
- KY-57, KY-65 Encryption set
- REMBASS Remotely monitored battlefield surveillance system
- PLRS position locator and reporting system
- RT-991 buoy radio
- RT-1175 buoy radio
- AN/TAS-4A TOW night sight



Electrical characteristics	12 V mode	24 V mode
Maximum OCV	16.5 V	33 V
Nominal voltage (at 500 mA)	13.5 V	27 V
Cut-off	10 V	20 V
Typical capacity +21°C / +70°F (at 2 A discharge current)	24.8 Ah at 12 V 12.4 Ah at 24 V	
Operating temperature	-40°C to +71°C / -40°F to +160°F	
Storage (Recommended max) (Possible)	+35°C / +95°F -40°C to +71°C / -40°F to +160°F	
Physical characteristics	Metric	Imperial
Typical weight	1.41 kg	3.1 lbs
Weight of Li metal content	34.0 g	1.2 oz
Width	62.2 mm	2.45 in
Height	111.8 mm	4.40 in
Depth	127.0 mm	5.00 in
Battery case	Plastic	
References		
Mating connector	IT Cannon CA 110821-6	
Reference specifications	Saft standard specification	
Nato Stock Number	6135-01-501-0833	

**This battery does not require an export license under ITAR rules when shipped to more than 30 countries. Please consult Saft.*

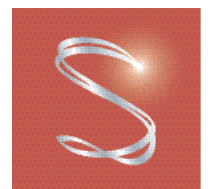

SAFT

BA 5390/U

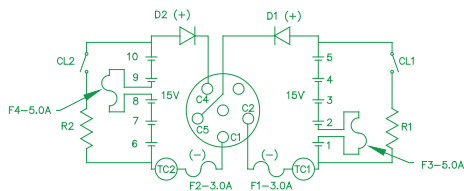
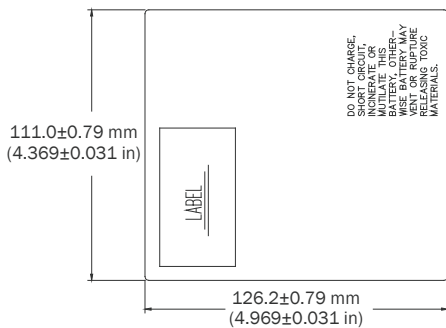
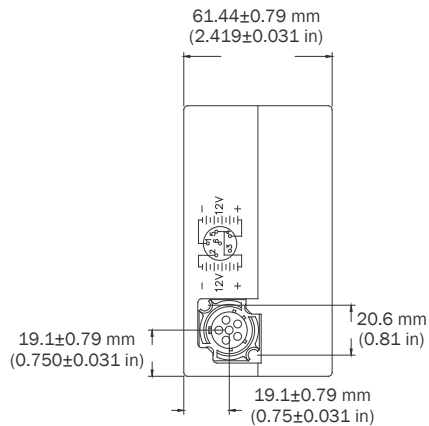

ELECTRICAL SCHEMATIC

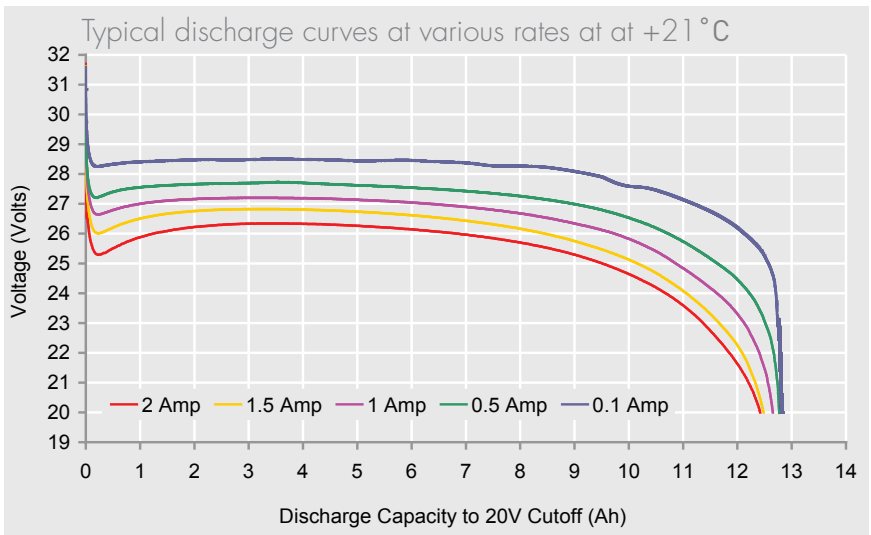
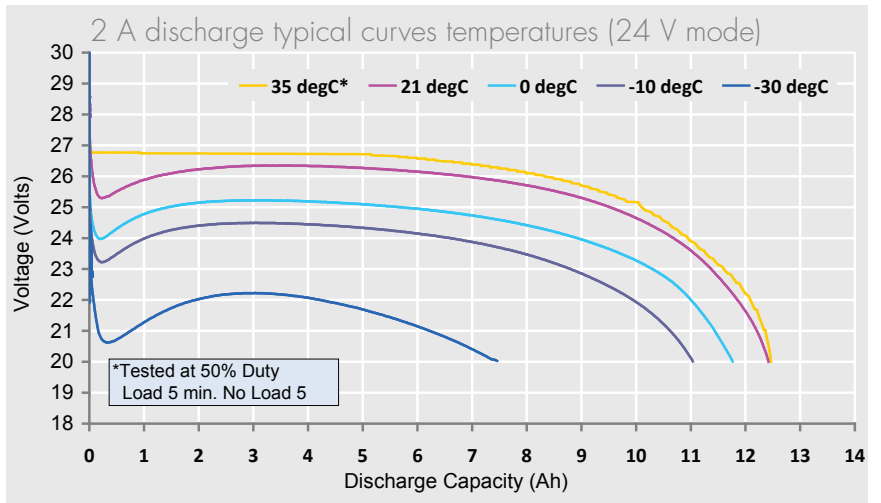
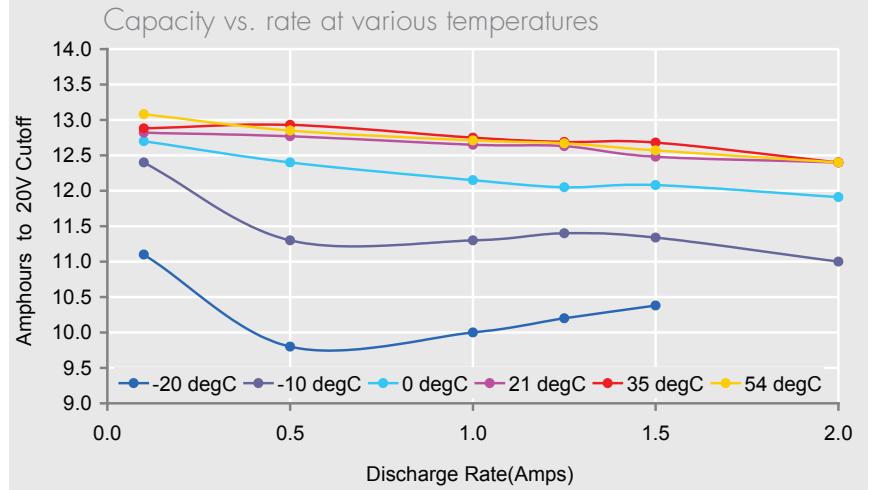

Saft
12, rue Sadi Carnot
93170 Bagnolet France
Tel.: +33 (0)1 49 93 19 18
Fax: +33 (0)1 49 93 19 69
www.saftbatteries.com

Saft
313 Crescent St.
Valdese, NC 28690 - USA
Tel.: +1 (828) 874 4111
Fax: +1 (828) 874 3981
www.saftbatteries.com

Doc N° 31104-2-1211
Edition: December 2011
Information in this document is subject to change
without notice and becomes contractual only after
written confirmation by Saft.
Published by the Communications Department
Photo credit: Saft