

CRYSTAL CONTROLLED OSCILLATORS

5.0V SURFACE MOUNT 11x6.35mm HCMOS CLOCK OSCILLATOR

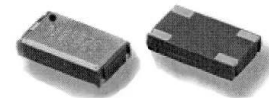

HSM626, HSM636

ABSOLUTE MAXIMUM RATINGS

TABLE 1.0

PARAMETER	UNITS	MINIMUM	NOMINAL	MAXIMUM	UNITS	NOTE
Storage Temperature		-55	-	125	°C	
Supply Voltage	(Vcc)	-0.5	-	7.0	Vdc	

MODEL SPECIFICATIONS:

TABLE 2.0

MODEL HSM626						
Frequency Range	(Fo)	1.8	-	80	MHz	
Frequency Tolerance:		-50	-	50	ppm	1
MODEL HSM636						
Frequency Range	(Fo)	1.8	-	80	MHz	
Frequency Tolerance:		-100	-	100	ppm	1

OPERATING SPECIFICATIONS

TABLE 3.0

PARAMETER		MINIMUM	NOMINAL	MAXIMUM	UNITS	NOTE
Operating Temperature Range		-40	-	85	°C	
Supply Voltage	(Vdd)	4.5	5.0	5.5	Vdc	
Supply Current	1.8 to 19.999 MHz	(Icc)	-	20	mA	
	20 to 49.999 MHz	(Icc)	-	30	mA	
	50 to 69.999 MHz	(Icc)	-	50	mA	
	70 to 80.0 MHz	(Icc)	-	80	mA	

INPUT CHARACTERISTICS

TABLE 4.0

Enable Voltage	(Vih)	2.2	-	-	Vdc	2
Disable Voltage	(Vil)	-	-	.08	Vdc	
Enable Time		-	-	100	nS	
Disable Time		-	-	100	nS	

HCMOS OUTPUT CHARACTERISTICS

TABLE 5.0

PARAMETER		MINIMUM	NOMINAL	MAXIMUM	UNITS	NOTE
LOAD		-	-	50	pF	
Voltage	(High)	(Voh)	4.50	-	Vdc	
	(Low)	(Vol)	-	0.50	Vdc	
Current	(High)	(Ioh)	-16	-	mA	
	(Low)	(Iol)	-	16	mA	
Duty Cycle at 50% of Vcc		45	50	55	%	
Rise / Fall Time 10% to 90%		-	-	5	nS	
Start-Up Time		-	-	10	mS	
Jitter (BW=10Hz to 20MHz)		-	-	5	ps rms	
Jitter (BW=12kHz to 20MHz)		-	-	1	ps rms	

PACKAGE CHARACTERISTICS

TABLE 6.0

Package	Hermetically sealed ceramic package and metal cover
---------	---

Note:

- Inclusive of calibration @ 25°C, frequency vs. temperature stability, supply voltage change, load change, shock and vibration, 10 years aging.
- Oscillator output is enabled with no connection on pad 1

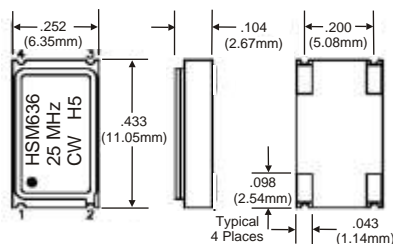

PAD	CONNECTION
1	ENABLE/DISABLE
2	GROUND
3	OUTPUT
4	VCC

Dimensional Tolerance: ±.02" (.508mm)
±.005" (.127mm)

DESCRIPTION

The Connor-Winfield models HSM626 and HSM636 are 5.0V HCMOS, Surface Mount, Fixed Frequency Crystal Oscillators (XO) designed for use in all applications requiring precision clocks over the -40 to 85°C, Commercial Temperature Range. The surface mount package is designed for high-density mounting and is optimum for mass production.

FEATURES

- 1.8 to 80 MHz
- 5.0V OPERATION
- TRI-STATE ENABLE / DISABLE FUNCTION
- OVERALL FREQUENCY TOLERANCE:
HSM626 ±50ppm
HSM636 ±100ppm
- TEMPERATURE RANGE: -40 to 85°C
- CERAMIC SURFACE MOUNT PACKAGE
- TAPE AND REEL PACKAGING
- RoHS COMPLIANT / Pb FREE

ORDERING INFORMATION

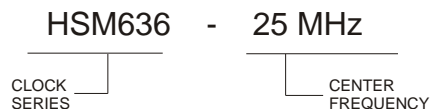

CRYSTAL CONTROLLED OSCILLATORS

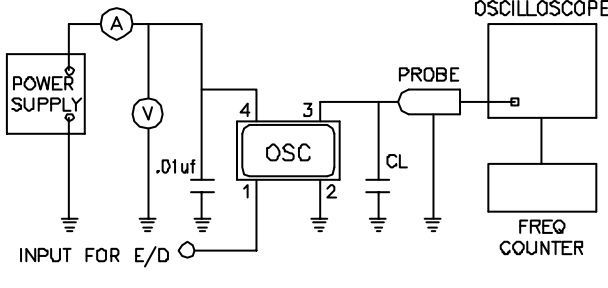
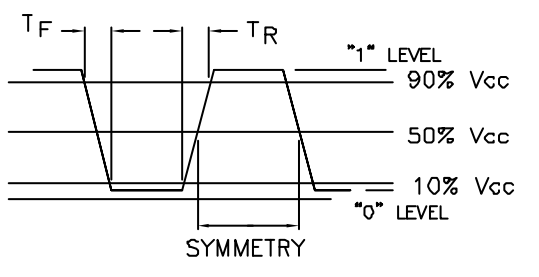
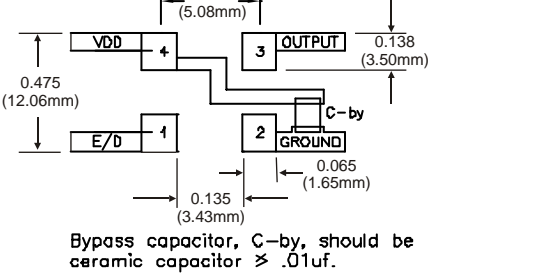
ENVIRONMENTAL CHARACTERISTICS	TEST CIRCUIT
<p>TEMPERATURE CYCLE: The specimen shall meet electrical characteristics after tested 5 cycles of -55°C/30 min & +125°C/30 min.</p> <p>HERMETICAL No bubbles appear in Flourinert (FC-43) at 125°C ±5°C, for 5 minutes.</p> <p>SOLVENT RESISTANCE: Marking will withstand immersion in Isopropyl Alcohol or Trichloroethylene.</p>	
<p>SOLDERING</p>	<p>OUTPUT WAVEFORM</p>
<p>GENERAL CONDITIONS: 260°C max x 10 sec max x 2 times max or 230°C max x 180 sec max x 1 time.</p> <p>TYPICAL OPERATION DATA (Vapor phase reflow) 20 to 100 sec up to 215°C, 50 sec at 215°C then down to room temperature per 1 to 5°C/sec</p>	
<p>MECHANICAL CHARACTERISTICS</p>	<p>SUGGESTED PAD LAYOUT</p>
<p>FREE DROP: The specimen shall meet electrical characteristics after tested 3 times Free Drop testing on the hard wooden board from a height of 75cm.</p> <p>VIBRATION: The specimen shall meet electrical characteristics after tested by the following conditions: 10-55Hz 1.5mm Amplitude, 55-2000Hz 20G's, 2 hours for each plane.</p> <p>THERMAL SHOCK: After applied Thermal Shock of 260°C max x 10 sec max x 2 times, or 230°C max x 180 sec max, the specimen shall meet electrical characteristics.</p> <p>SOLDERABILITY: (EIAJ-RGX-0102/1D1 Condition 1a) 1. Flux: MIL-F-14256 (WW Rosin=25%, Isopropyl alcohol=75%) 2. Solder: QQ-S-571 (Sn=63%, Pb=37%) 3. Solder bath temperature: 235°C ±5°C. 4. Depth of immersion: Up to electrical terminal. 5. Immersing time: Within 2 sec ±0.5 sec into solder bath. After performing the above procedures, a newly soldered coverage shall be greater than 90%.</p>	
<p>TAPING AND REEL DIMENSIONS</p>	

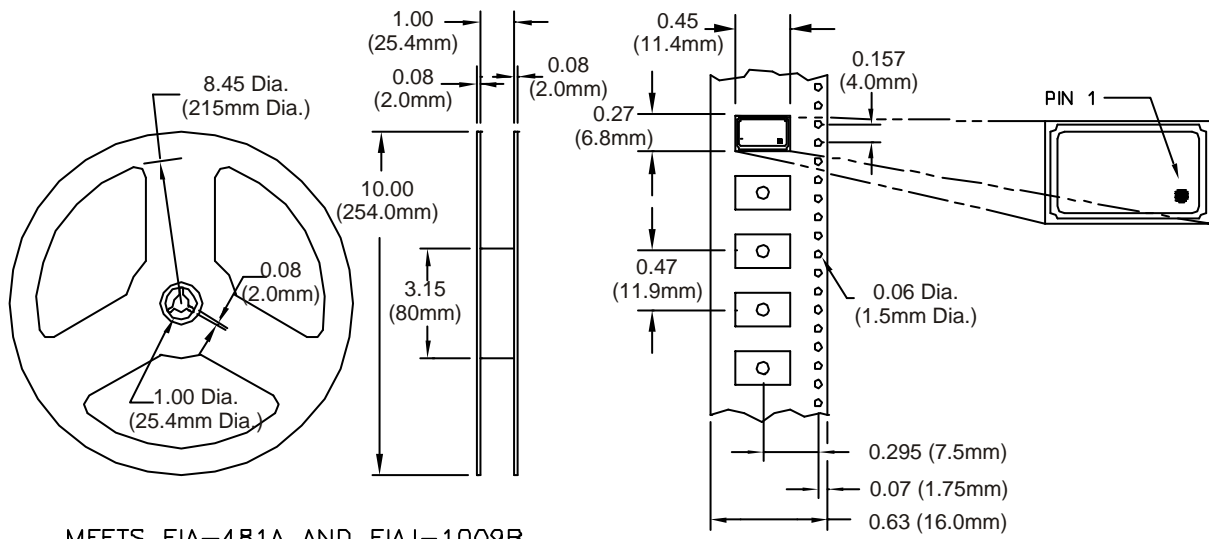

MEETS EIA-481A AND EIAJ-1009B
1000 PCS / REEL