

**SURFACE MOUNT GLASS PASSIVATED
FAST RECOVERY SILICON RECTIFIER**
VOLTAGE RANGE 50 to 1000 Volts CURRENT 2.0 Amperes

FEATURES

- * Glass passivated device
- * Ideal for surface mounted applications
- * Low leakage current
- * Metallurgically bonded construction
- * Mounting position: Any
- * Weight: 0.098 gram

MECHANICAL DATA

- * Epoxy : Device has UL flammability classification 94V-0

MAXIMUM RATINGS AND ELECTRICAL CHARACTERISTICS

Ratings at 25 °C ambient temperature unless otherwise specified.
Single phase, half wave, 60 Hz, resistive or inductive load.
For capacitive load, derate current by 20%.



DO-214AA

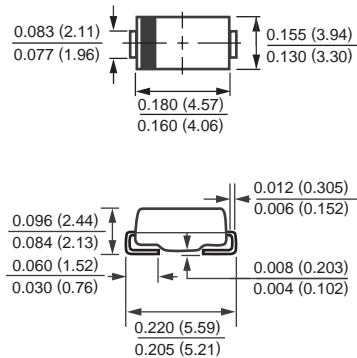

Dimensions in inches and (millimeters)

MAXIMUM RATINGS (At TA = 25°C unless otherwise noted)

RATINGS	SYMBOL	FFM201	FFM202	FFM203	FFM204	FFM205	FFM206	FFM207	UNITS	
Maximum Recurrent Peak Reverse Voltage	VRRM	50	100	200	400	600	800	1000	Volts	
Maximum RMS Voltage	VRMS	35	70	140	280	420	560	700	Volts	
Maximum DC Blocking Voltage	VDC	50	100	200	400	600	800	1000	Volts	
Maximum Average Forward Rectified Current at TA = 55°C	IO	2.0								Amps
Peak Forward Surge Current 8.3 ms single half sine-wave superimposed on rated load (JEDEC method)	IFSM	70								Amps
Maximum Thermal Resistance	(Note 2) RθJL	20								°C/W
	(Note 3) RθJA	60								°C/W
Typical Junction Capacitance (Note 1)	CJ	50								pF
Operating and Storage Temperature Range	TJ, TSTG	-55 to + 150								°C

ELECTRICAL CHARACTERISTICS (At TA = 25°C unless otherwise noted)

CHARACTERISTICS	SYMBOL	FFM201	FFM202	FFM203	FFM204	FFM205	FFM206	FFM207	UNITS	
Maximum Forward Voltage at 2.0A DC	VF	1.3								Volts
Maximum Full Load Reverse Current, Full cycle Average at TA=55°C	IR	50								uAmps
Maximum DC Reverse Current at @TA = 25°C		5.0								uAmps
Rated DC Blocking Voltage @TA = 125°C		200								uAmps
Maximum Reverse Recovery Time (Note 4)	trr	150			250		500		nSec	

- NOTES : 1. Measured at 1.0 MHz and applied average voltage of 4.0VDC
 2. Thermal resistance junction to terminal 6.0mm² copper pads to each terminal.
 3. Thermal resistance junction to ambient, 6.0mm² copper pads to each terminal.
 4. Test Conditions: IF = 0.5A, IR = -1.0A, IRR = -0.25A

RATING AND CHARACTERISTIC CURVES (FFM201 THRU FFM207)

FIG. 1 - TYPICAL FORWARD CURRENT DERATING CURVE

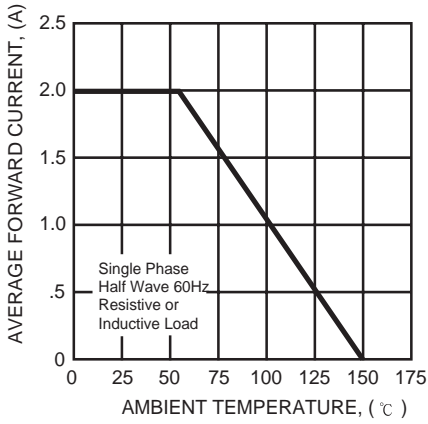

FIG. 2 - MAXIMUM NON-REPETITIVE FORWARD SURGE CURRENT

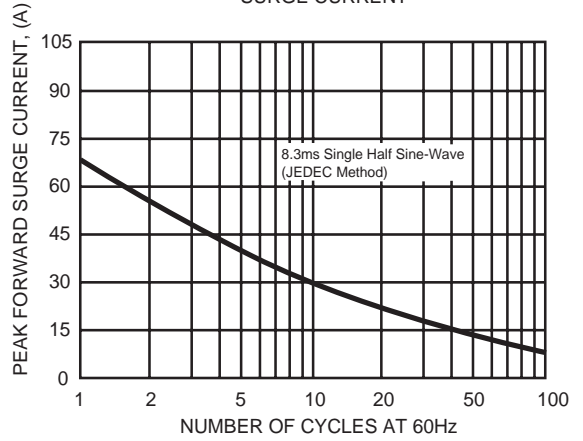

FIG. 3 - TYPICAL INSTANTANEOUS FORWARD CHARACTERISTICS

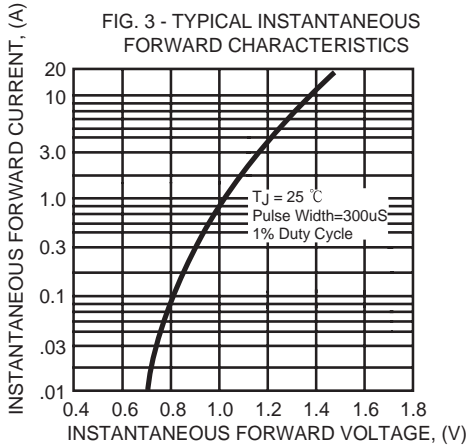

FIG. 4 - TYPICAL JUNCTION CAPACITANCE

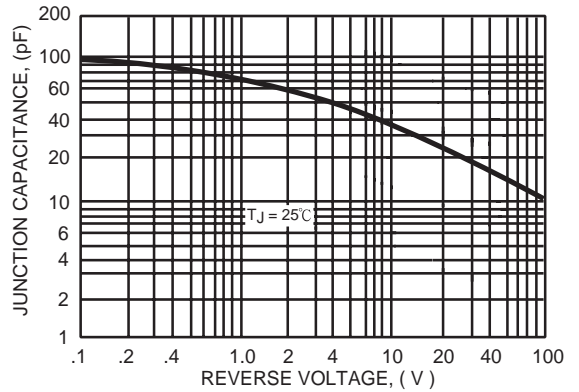
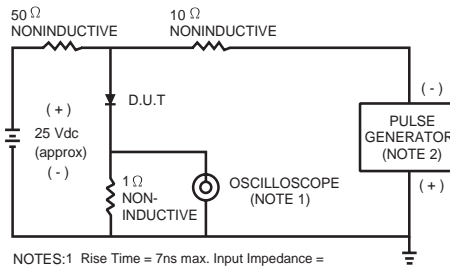
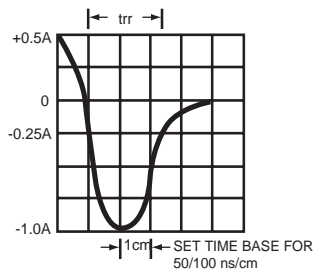

FIG. 5 - TEST CIRCUIT DIAGRAM AND REVERSE RECOVERY TIME CHARACTERISTIC



- NOTES: 1 Rise Time = 7ns max. Input Impedance = 1 megohm. 22pF.
2. Rise Time = 10ns max. Source Impedance = 50 ohms.



Mounting Pad Layout

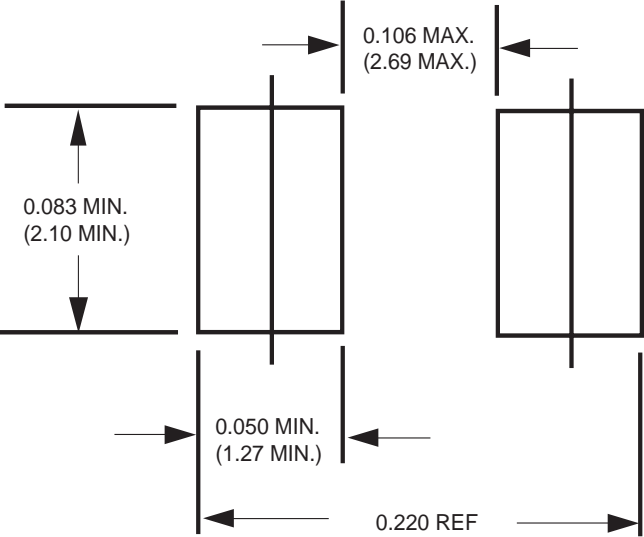

Dimensions in inches and (millimeters)