

Ambient Light and Proximity Sensor with Integrated 850nm IR Emitter

Umgebungslicht- und Proximity Sensor mit integriertem 850nm IR Emitter

Version 0.1

SFH 7776

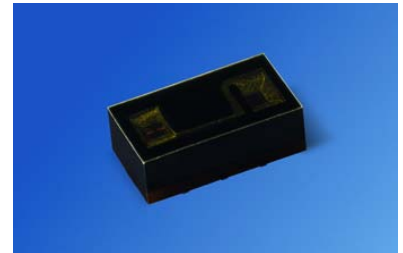

Features:

- Proximity sensor (PS)
 - Detection range up to 160 mm
 - 850 nm IR emitter integrated in package
 - Programmable pulse current up to 200 mA
 - No separator needed if placed <0.4mm behind glass window, window thickness <1.0 mm
- Ambient light sensor (ALS)
 - detection range 0.0022 - 73000 lx;
 - 50Hz/60Hz flicker noise suppression
- I²C interface (max. 400kHz)
- PS and ALS Interrupt function
- Current consumption
 - typ. 0.8µA in Standby mode
 - typ 90µA for ALS operation
 - typ 60µA for PS operation
- Miniature package 4mm x 2.1mm x 1.35mm

Applications

- Mobile phones
- PDAs and notebooks
- Cameras
- Consumer products

Besondere Merkmale:

- Näherungssensor (PS)
 - Detektionsbereich bis zu 160mm
 - 850 nm Emitter, im Gehäuse integriert
 - Programmierbarer Pulsstrom bis 200 mA
 - Funktion ist auch bei Abdeckung mit einem Glasfenster gegeben (Abstand des Glases <0.4mm, Fensterdicke <1.0mm)
- Umgebungslichtsensor (ALS)
 - ALS-Bereich 0.0022 - 73000 lx
 - Unterdrückung von 50Hz/60Hz basierten Umgebungslichtstörungen
- I²C interface (max. 400kHz)
- Interrupt Funktion für PS und ALS
- Stromverbrauch
 - typ 0.8µA im Standby Modus
 - typ 90µA im ALS Modus
 - typ 60µA im PS Modus
- Kleines Gehäuse 4mm x 2.1mm x 1.35mm

Anwendungen

- Mobiltelefone
- PDAs und Notebooks
- Kameras
- Consumer-Produkte

Ordering Information Bestellinformation

Type:	Ordering Code
Typ:	Bestellnummer
SFH 7776	Q65111A4188

Application diagram

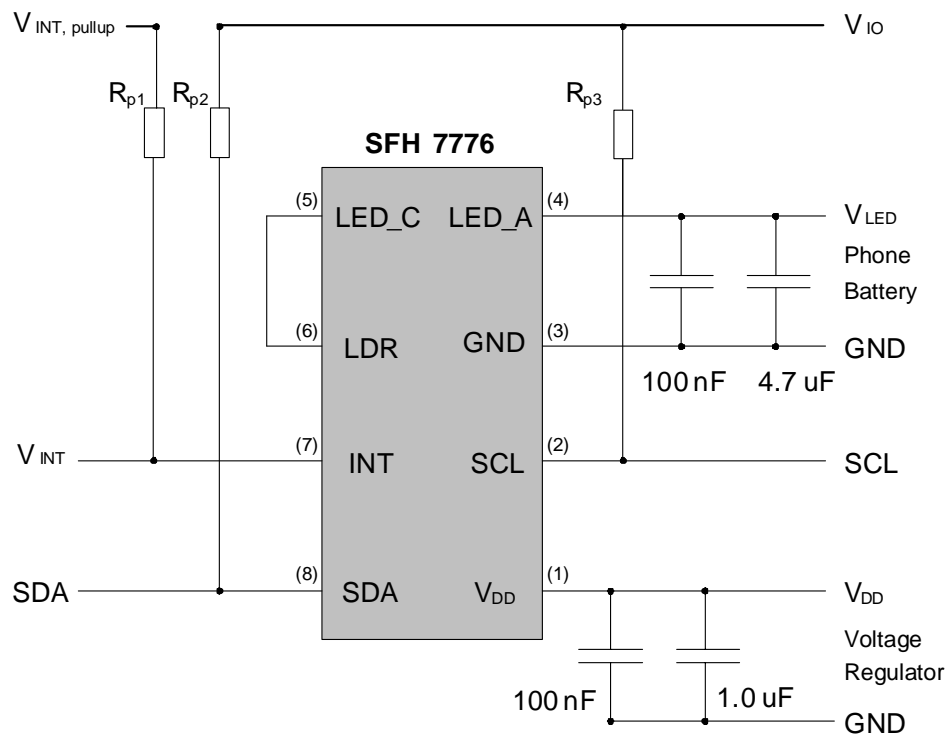

- Bypass capacitors for V_{DD} and V_{LED} are required for proper operation of the device.
- Proposed size for the pull-up resistors R_{p1}, R_{p2} and R_{p3} are 10kOhm

- Pin description

Pin	Name	Function
1	V _{DD}	Power supply pin
2	SCL	I ² C bus serial clock pin
3	GND	Ground pin
4	LED_A	Anode of the LED
5	LED_C	Cathode of the LED
6	LDR	LED driver pin
7	INT	Interrupt pin; open drain output; configured via I ² C bus
8	SDA	I ² C bus serial data pin

Short Evaluation program

Adress	Command	Action
0x42	0x3F	set LED pulse current to 200mA and ALS gain to x128
0x41	0x06	activate ALS & PS with a measurement repetition time of 100ms
Wait 100ms		
0x44	read data	read LSB of proximity measurement data
0x45	read data	read MSB of proximity measurement data
0x46	read data	read LSB of ambient light measurement of VIS diode
0x47	read data	read MSB of ambient light measurement of VIS diode
0x48	read data	read LSB of ambient light measurement of IR diode
0x49	read data	read MSB of ambient light measurement of IR diode

I²C interface

- I/O-pins are open drain type and logic high level is set with external pull-up resistor
- SFH 7776 operates in slave mode. Slave address is 0111001 (0x39h)
- Designed for the I²C Fast mode (400 kb/s)
- Interrupt pin (INT): open-drain output (like SDA and SCL)

Block diagram

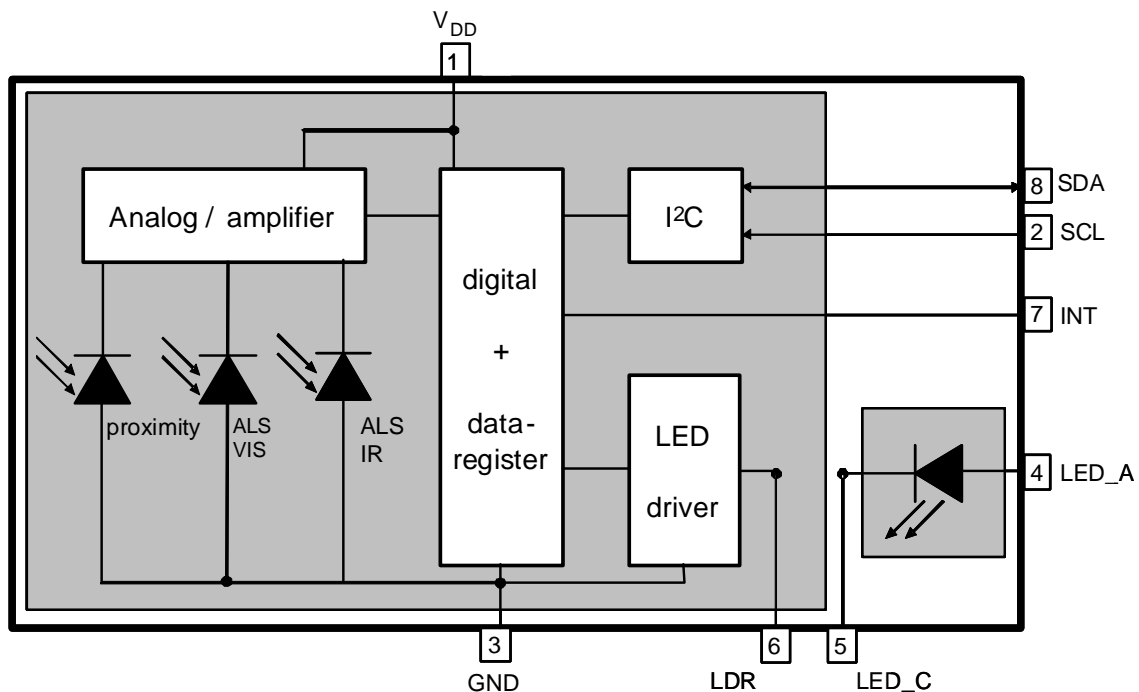

Measurement modes

Mode	Description
OFF	The device is inactive. Other units may use the I ² C bus without any restrictions; I/O pins and INT are in high Z state. There is no sink current through the LED
STAND-BY	This is the initial mode after power-up. I_{DD} is typ. 0.8μA. No measurement is performed. Device can be activated by I ² C bus communication. Data registers can be read and written.
ALS / PS free - RUNNING	Measurements are triggered internally by the SFH 7776. Stand-by / active mode for ALS and PS, measurement times, interrupt options and LED current can be adjusted via I ² C register. Measurement results can be read from the data register, the status from the interrupt register.

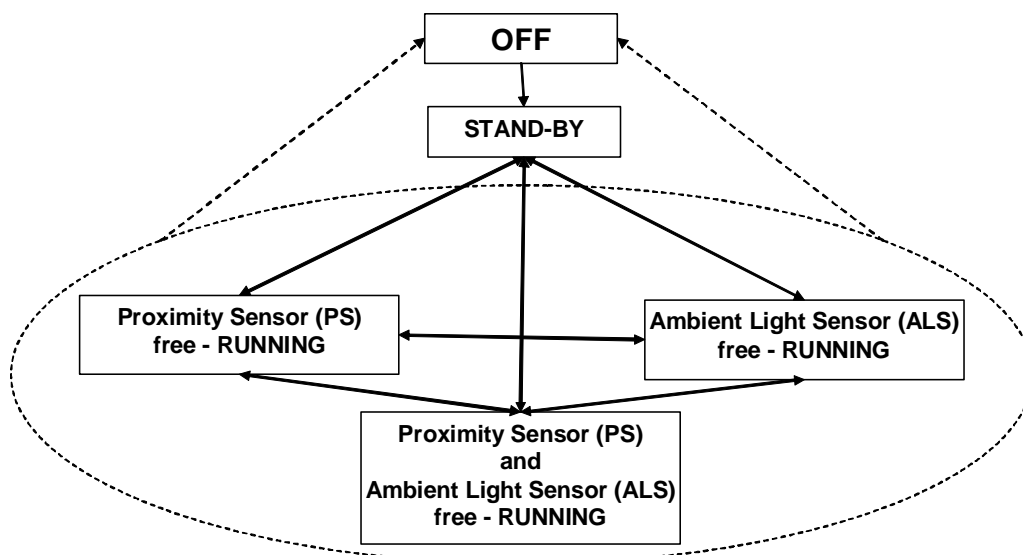

If V_{DD} exceeds the threshold voltage, the sensor will switch from OFF mode to STAND-BY mode. As shown in the transition-diagram above it is possible to switch between all modes without any restriction.

Maximum Ratings ($T_A = 25\text{ °C}$)

Parameter	Symbol	Values	Unit
Storage temperature range	T_{stg}	-40 ... 100	°C
Operating temperature range	T_{op}	-40 ... 85	°C
Maximum supply voltage (between V_{DD} and GND)	V_{DD}	4.5	V
Maximum voltage of SDA, SCL to GND	V_{dig}	4.5	V
Maximum voltage of INT to GND	V_{int}	7	V
Maximum voltage of VLED to GND	V_{LED}	7	V
Maximum Current of INT and SDA	I_{INT} / I_{SDA}	7	mA
Electrostatic discharge - Human Body Model (according to ANSI / ESDA JEDEC JS-001-2011; Class2)	<i>ESD</i>	2	kV

Operating conditions ($T_A = 25\text{ °C}$)

Parameter	Symbol	Value			Unit
		min.	typ.	max.	
Supply voltage	V_{DD}	2.3	2.5	3.6	V
Ripple on supply voltage (V_{DDmin} and V_{DDmax} must stay in the V_{DD} range, DC ... 100MHz)	$V_{DD,rip}$			200	mV
VDD threshold voltage (voltage to initiate the start-up procedure)	$V_{DD; th}$		1.7	2.3	V
Voltage for INT	V_{INT}			5.5	V
Voltage for SCL and SDA	V_{SCL} V_{SDA}	1.65		3.6	V
SDA and SCL input low level voltage	V_{SCL_low} V_{SDA_low}			0.54	V
SDA and SCL input high level voltage	V_{SCL_high} V_{SDA_high}	1.26			V
SDA and SCL input current	I_{SCL_low} I_{SDA_low}	-10		10	μ A
INT output low level voltage ($I_{INT} = 3\text{ mA}$) (When INT is active: $V_{INT} = \text{low}$ when INT is inactive: $V_{INT} = \text{high}$)	V_{INT_low}			0.4	V
Supply voltage LED ¹⁾	V_{LED}	2.3	3.5	5.5	V
Ripple VLED	$V_{LED,rip}$			200	mV

¹⁾2.3 V is only valid for an LED current setting up to 100mA; If the sensor is driven with LED currents >100mA the VLED voltage should be higher than 3.0V.

Characteristics ($T_A = 25\text{ °C}$)

Parameter	Symbol	Value			Unit
		min.	typ.	max.	

General

Conditions for OFF mode	$V_{DD,off}$		0.5		V
Current consumption in OFF mode ($V_{DD} < 0.5V$)	$I_{DD,off}$		0		μA
STAND-BY mode current consumption (Mode_control(41h) = 0x00; $V_{DD} = 2.5V$)	$I_{DD,stby}$		0.8	1.5	μA

Proximity Sensor (PS)

LED centroid wavelength ($I_{LED} = 100mA$)	$\lambda_{centroid}$		850		nm
LED Spectral bandwidth ($I_{LED} = 100mA$)	$\Delta\lambda$		30		nm
Temperature coefficient of optical power of LED	TC		-0.5		%/K
ILED ON time for one measurement	$t_{LED\ ON}$	80	200	300	μs
LED current, programmable $V_{LED} > 2.3V$ for $I_{LED} < 100mA$ $V_{LED} > 3.0V$ for $I_{LED} > 100mA$	I_{LED}	25		200	mA
Accuracy of LED current source (ALS_PS_CONTROL: LED Current = 00b)	I_{LED}	22.5	25	27.5	mA
Mean current consumption in PS mode (current consumption of the pulsed LED is not included; MODE_CONTROL(0x41h) = 0x03h; all other registers are default; $V_{DD} = 2.5V$)	I_{DD}		60	150	μA
Mean current consumption in PS mode during the 200 μs LED pulse ($t_{LED\ ON}$) (current consumption of the pulsed LED is not included)	I_{DD}		6.5	8.5	mA
Typical detection distance ¹⁾ KODAK grey card 100x130mm ² , R=90% ($I_{LED}=200mA$, $V_{DD}=2.5V$, $E_v = 0lx$; high threshold = 11 counts)	h_{on}		10		cm

Typical none detection distance ¹⁾ KODAK grey card 100x130mm ² , R=90% ($I_{LED}=200\text{mA}$, $V_{DD}=2.5\text{V}$, $E_v = 0\text{lx}$ low threshold = 8 counts)	h_{off}		12		cm
PS sensor output with human skin reflector ($I_{LED}=200\text{mA}$, $V_{DD}=2.5\text{V}$, $h=0\text{mm}$: skin directly on top of the sensor)	PS_{out}		850		counts
Temperature coefficient of the PS signal ($I_{LED}=200\text{mA}$, $V_{DD}=2.5\text{V}$, R=90%, $A_{Reflector} = 10 \times 13 \text{cm}^2$, $h=4\text{cm}$)	TK_{PS}		0.15		%/K

1) Example of PS Hysteresis

The switching distance h is specified from top sensor surface to the reflector.

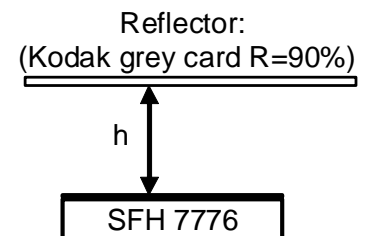
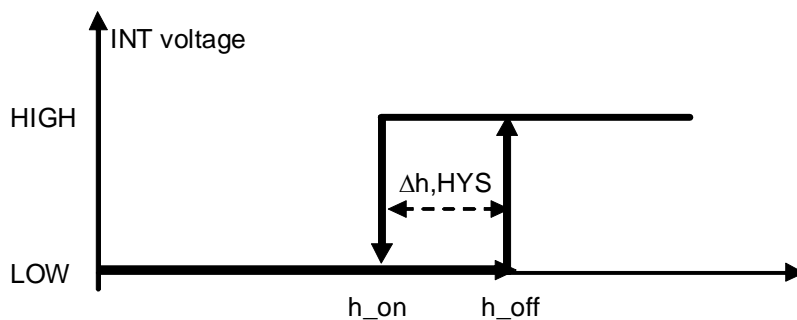

Characteristics (Ta = 25°C)

Parameter	Symbol	Value			Unit
		min.	typ.	max.	

Ambient Light Sensors: ALS VIS and ALS IR diode

Wavelength of max. sensitivity for ALS VIS	λS_{\max}		560		nm
Spectral range of sensitivity (10% of S_{\max}) of ALS VIS	$\lambda S_{10\%}$	450		950	nm
Wavelength of max. sensitivity of ALS IR	λS_{\max}		880		nm
Spectral range of sensitivity (10% of S_{\max}) of ALS IR	$\lambda S_{10\%}$	830		1050	nm
Illuminance measurement range is programmable (the maximum ALS sensitivity can be reached with the ALS high sensitivity mode --> 400ms ALS integration time) (MODE_CONTROL (0x41h) = 0Ah or 0Bh)		0.0022		73000	lx
ALS VIS sensor output (1000lx; white LED; $V_{DD} = 2.5V$) (MODE_CONTROL (0x41h) = 08h) (ALS_PS_CONTROL (0x42h): Gain = X1)	ALS _{VIS_out}	750	900	1080	counts
ALS IR sensor output (324 μ W/cm ² ; IRED 850 nm; $V_{DD} = 2.5V$) (MODE_CONTROL (0x41h) = 08h) (ALS_PS_CONTROL (0x42h): Gain = X1)	ALS _{IR_out}	460	550	660	counts
ALS VIS sensor output at darkness (MODE_CONTROL (0x41h) = 08h) (ALS_PS_CONTROL (0x42h): Gain = X1)	ALS _{VIS_out}	0	0	2	counts
ALS IR sensor output at darkness (MODE_CONTROL (0x41h) = 08h) (ALS_PS_CONTROL (0x42h): Gain = X1)	ALS _{IR_out}	0	0	2	counts

Parameter	Symbol	Value			Unit
		min.	typ.	max.	
Resolution of the digital output signal based on gain settings for ALS VIS: MODE_CONTROL (0x41h) = 08h $t_{\text{int ALS}} = 100\text{ms}$ Gain X1 Gain X2 Gain X 64 Gain X 128 <i>High sensitive mode:</i> MODE_CONTROL (0x41h) = 0Ah $t_{\text{int ALS}} = 400\text{ms}$ Gain X 128 ($V_{\text{DD}} = 2.5\text{V}$; white LED) - Gain settings at ALS_PS_CONTROL (0x42h)	$ALS_{\text{VIS_out}}$		1.1 0.55 0.018 0.009 0.002		lx/count
Typical temperature coefficient for ALS measurement (1000lx; white LED; $V_{\text{DD}} = 2.5\text{V}$)	TC_{Ev}		0.2		%/K
Mean current consumption ((MODE_CONTROL (0x41h) = 08h) (other registers are in default)	I_{DD}		90	150	μA
Typical error by Flicker noise (caused by bulbs (f=50 or 60Hz) or fluorescent lamps)				3	%

Diagrams for ALS sensor

Relative Spectral Sensitivity of ALS VIS

$$S_{\text{rel_VIS}} = f(\lambda)$$

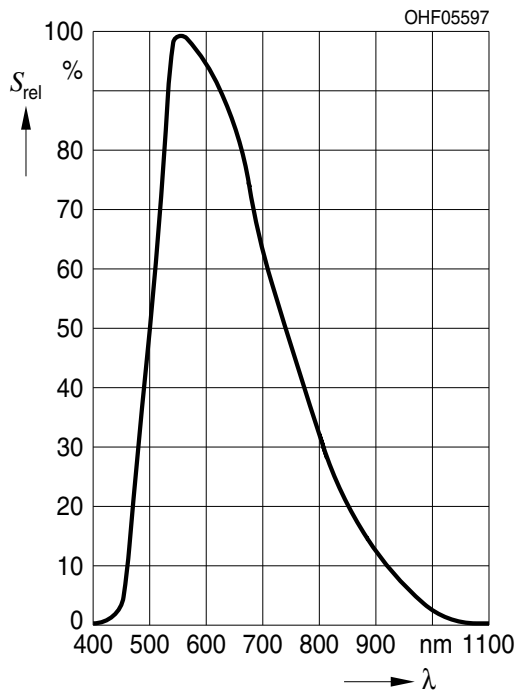

Relative Spectral Sensitivity of ALS IR

$S_{\text{rel_IR}} = f(\lambda)$; 100% = maximum sensitivity of ALS VIS diode

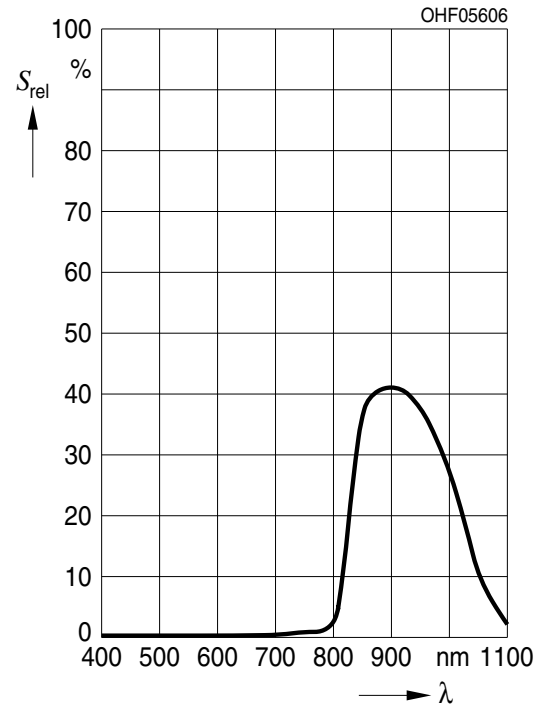

ALS VIS sensitivity ranges

ALS VIS output $f(E_V)$; white LED; f (sensitivity settings);

T_{int} : integration time (register 0x41h); X: gain settings (register 0x42h)

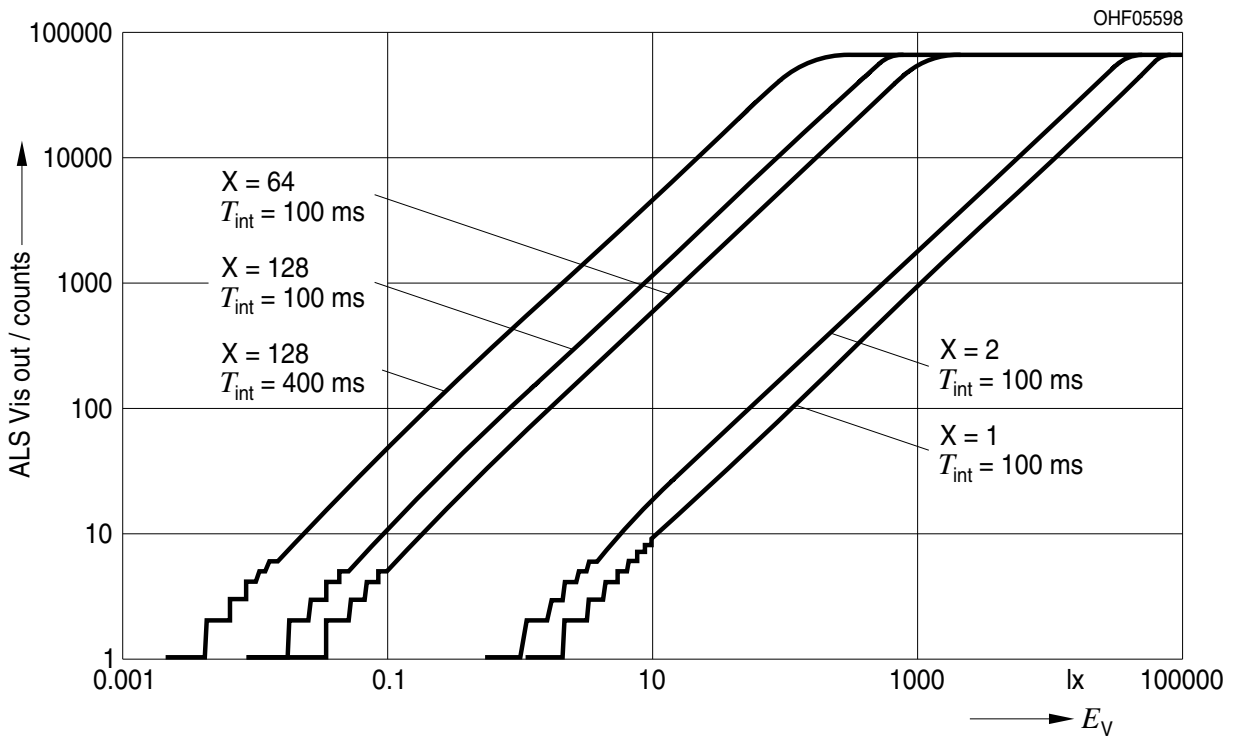

Direction Characteristic of ALS Vis diode

$S_{rel} f(\varphi)$

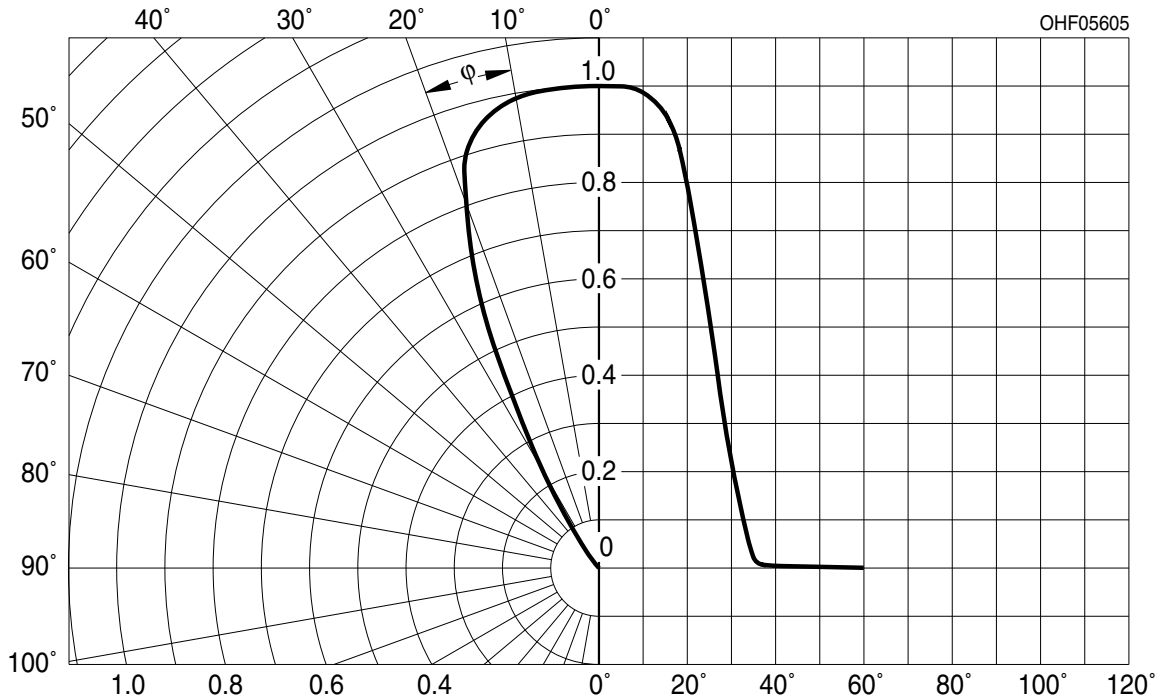

Diagrams for PS sensor

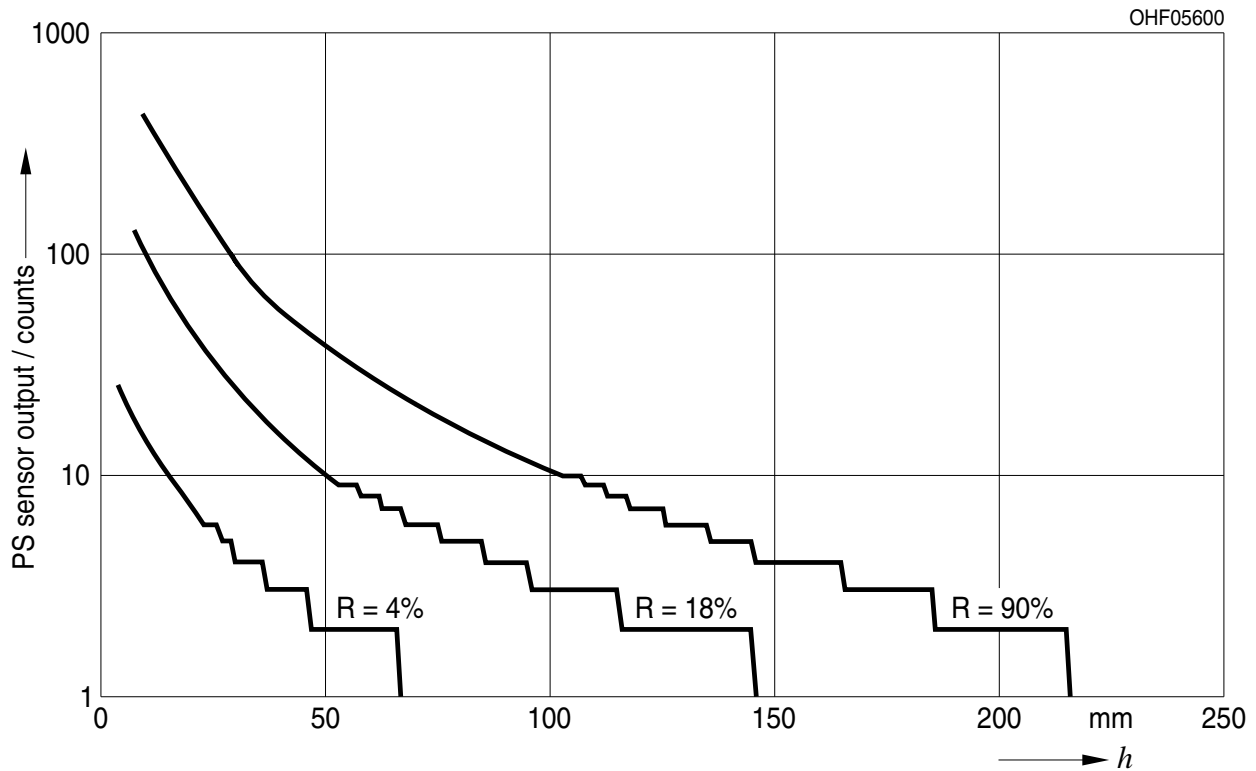
PS sensitivity $f(R = \text{reflectivity})$ $V_{DD}=2.5V$; $I_{LED}=200mA$; $T_{rep}=100ms$; $A_{Reflector} = 10 \times 13 \text{ cm}^2$ 

PS sensitivity $f(I_{LED})$

$V_{DD}=2.5V$; $T_{rep}=100ms$; $R=90\%$; $A_{Reflector} = 10 \times 13 \text{ cm}^2$

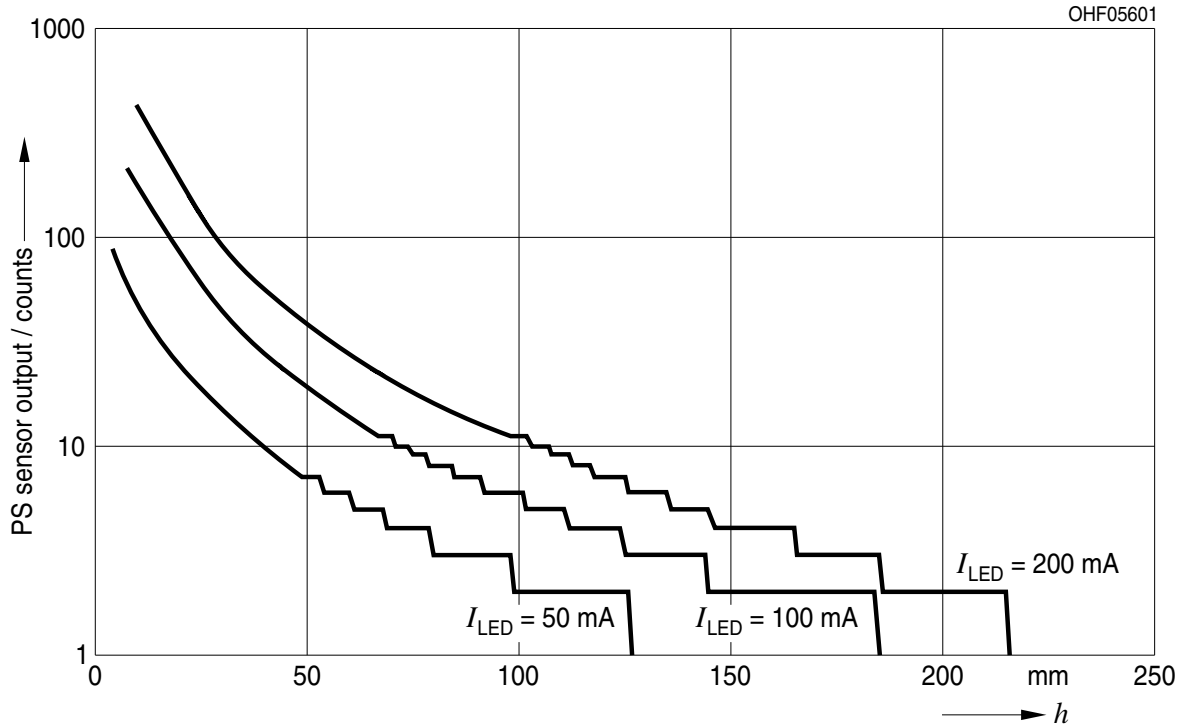

Typical crosstalk free range

$V_{DD}=2.5V$; $I_{LED}=200mA$; $T_{rep}=100ms$; glass without ink and one single IR transmissive opening ;

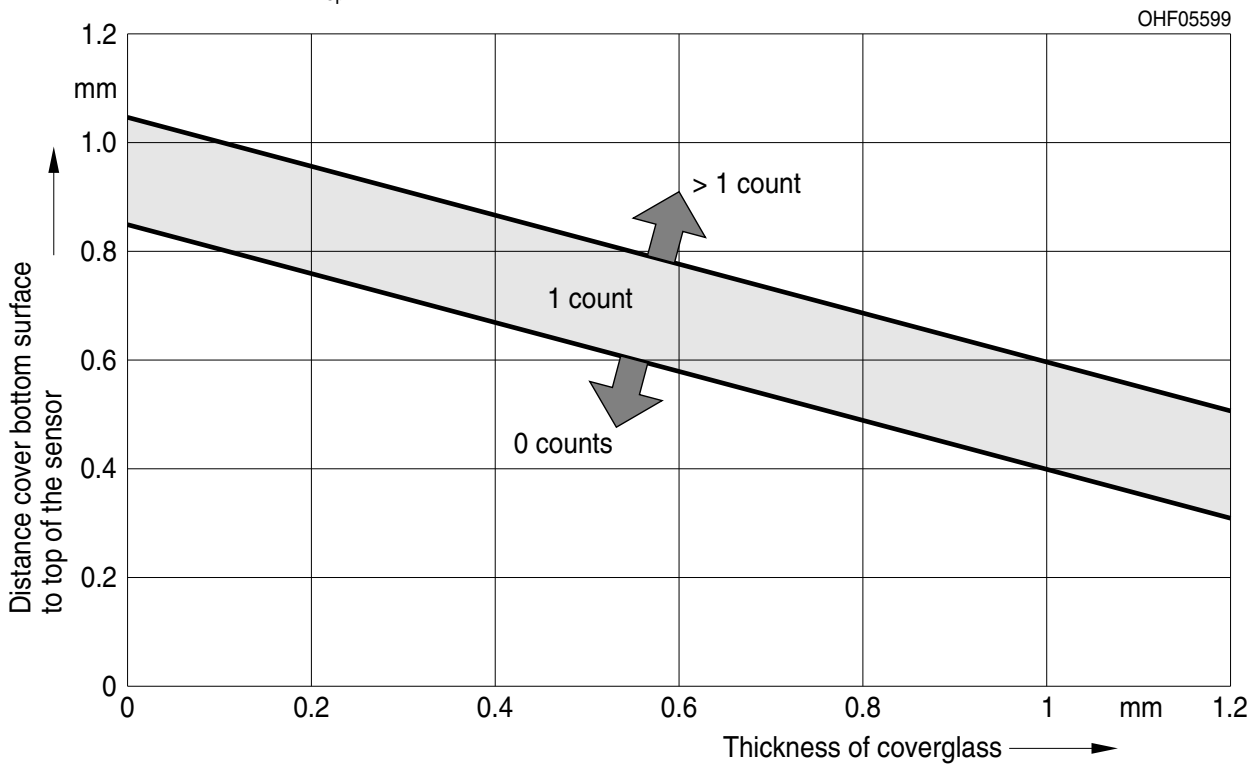

Typical crosstalk free range

$V_{DD}=2.5V$; $I_{LED}=200mA$; $T_{rep}=100ms$; glass without ink and a two separate IR transmissive openings for emitter and detector

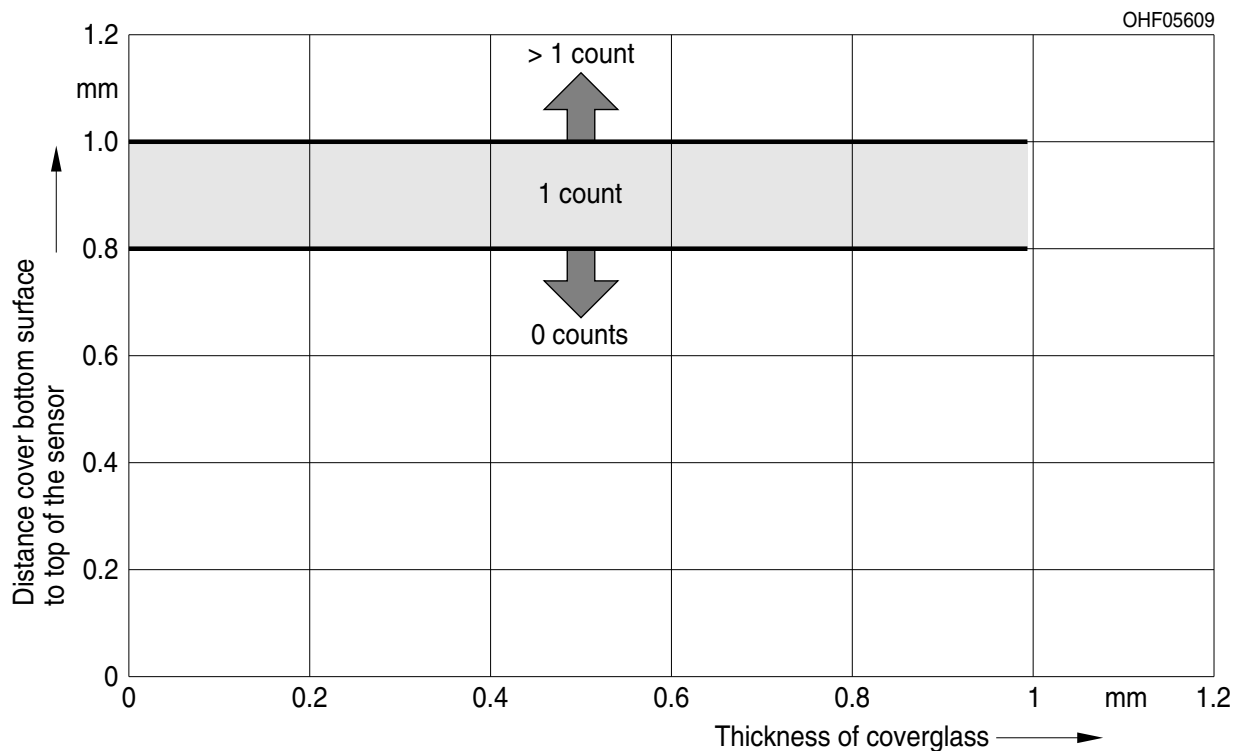

Note for crosstalk free range: The displayed crosstalk free ranges for a single or two hole IR transmissive opening are measured with a clear cover. Depending on the used ink the crosstalk level can differ and needs to be measured. OSRAM OS provides customer related application support and measurements - please contact your OSRAM OS marketing or sales partner, if support is required.

As the measurement results show the typical performance of the sensor OSRAM OS recommends to design in an additional safety guard in the distance of the cover bottom surface to the top of the sensor of 200µm. e.g.: for a 0.5mm thick cover window with two holes and an acceptable crosstalk level of 0 counts the distance of the cover window bottom surface to the top of the sensor should not exceed 0.6mm (typ. it would be 0.8mm)!

Radiation Characteristics of the IR Emitter

$I_{rel} f(\varphi)$

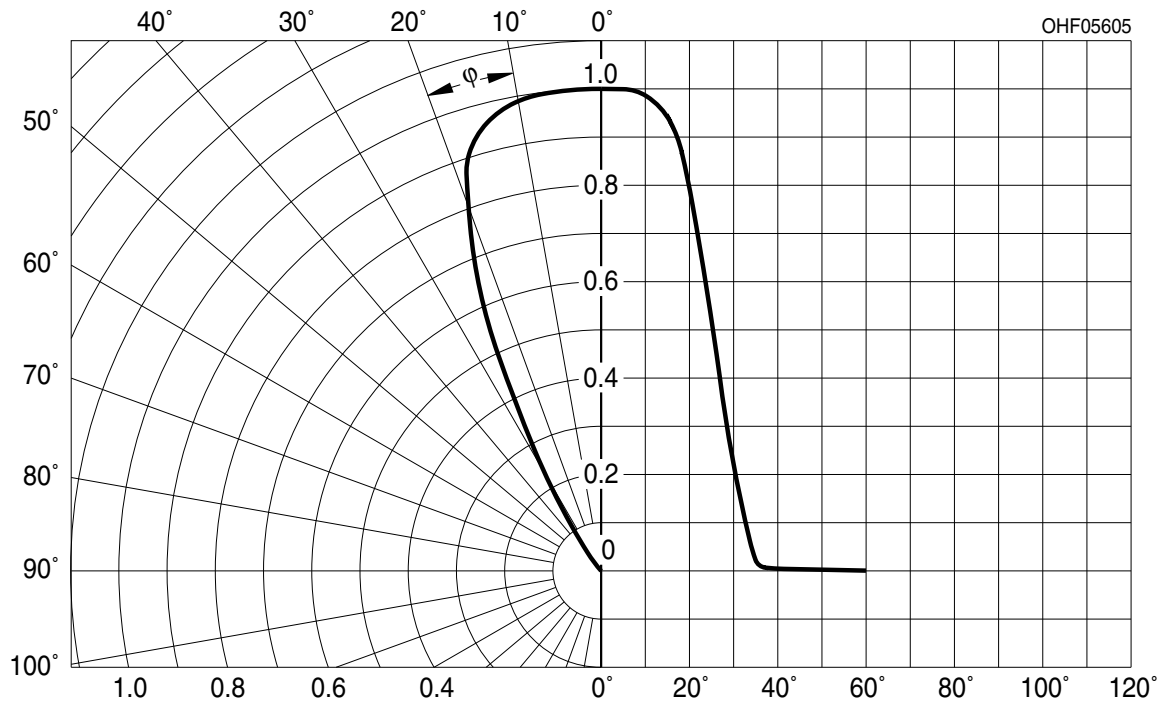

Diagrams for I_{DD} current consumption

Current consumption I_{DD} in standby mode

$I_{DD} = f(V_{DD})$; Register 0x41= 0x00

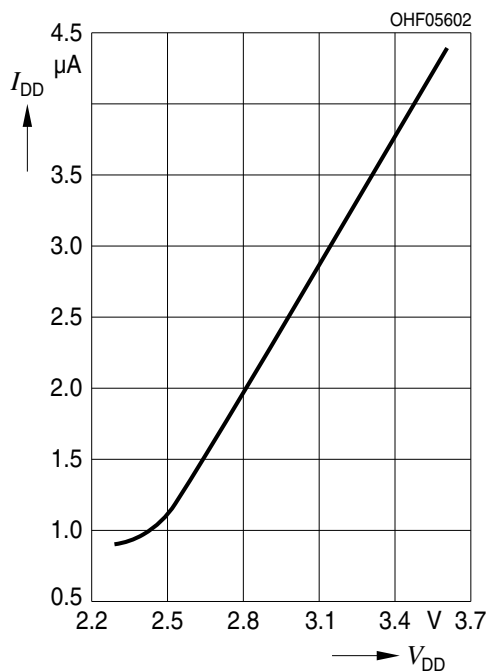

Current consumption I_{DD} in PS mode

$I_{DD} = f(V_{DD})$; Register 0x41= 0x03

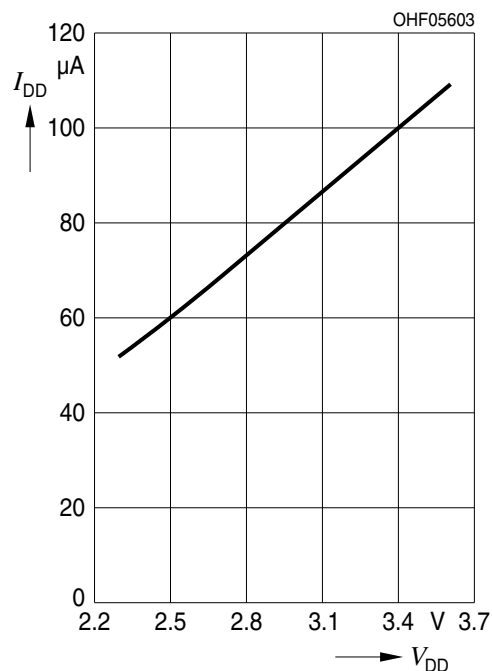

Current consumption I_{DD} in ALS mode

$I_{DD} = f(V_{DD})$; Register 0x41= 0x08

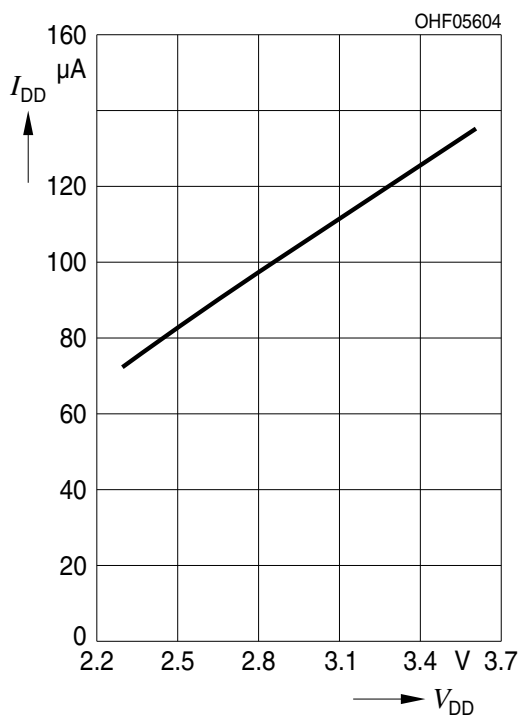

Register

SYSTEM_CONTROL register (0x40h)

The SYSTEM_CONTROL register is used to control the software (SW) reset and the interrupt function (INT). Manufacturer ID and Part ID can be read.

R/W-Register 0x40								
Bit	7	6	5	4	3	2	1	0
	SW reset	INT reset	Manufacturer ID (Read only)			Part ID (Read only)		
default	0 Initial reset is not started	0 INT pin status is not initialized	001			001		
	0 Initial reset is not started	0 INT pin status is not initialized						
	1 Initial reset started	1 INT pin become inactive (high impedance)						

MODE_CONTROL register (0x41h)

CONTROL of PS and ALS operating modes and time settings.

Repetition time is the time between two separate measurements. Integration time is the duration for one measurement. ALS high sensitivity modes are 1010 and 1011 with an increased integration time of 400ms. In PS operating mode: „normal mode“ only one PS measurement is performed during one PS repetition time. In PS operating mode „twice mode“ two independent PS measurement are performed within one PS repetition time. Both measurements are independent and can trigger the interrupt. This feature can be used to decrease the interrupt update time if the persistence function (register 0x43h) is used.

R/W-Register 0x41											
Bit	7	6	5	4		3	2	1	0	Repetition / Integration time	Repetition time
	Reserved		PS operating mode						ALS	PS	
default			0 normal mode			0000			standby	standby	
			0 normal mode			0000			standby	standby	
			1 twice mode			0001			standby	10ms	
						0010			standby	40ms	
						0011			standby	100ms	
						0100			standby	400ms	
						0101			100ms / 100ms	standby	
						0110			100ms / 100ms	100ms	
						0111			100ms / 100ms	400ms	
						1000			400ms / 100ms	standby	
						1001			400ms / 100ms	100ms	
						1010			400ms / 400ms	standby	
						1011			400ms / 400ms	400ms	
						1100			50ms / 50ms	50ms	
						Rest forbidden					

ALS_PS_CONTROL register (0x42h)

ALS and PS Control of set the PS output mode, the ALS gain and the LED current. In the „Infrared DC level output“ PS mode (bit <6> = 1) the sensor measures the infrared DC ambient level. The proximity value of the reflected signal is not available in this mode.

R/W-Register 0x42											
Bit	7		6		5	4	3	2	1		0
	Reserved (read only)		PS output		ALS Gain for ALS VIS and ALS IR					LED current	
							ALS VIS		ALS PS		
default	write 0		0 proximity output		0000		X1		X1		11 200mA

R/W-Register 0x42								
Bit	7	6	5	4	3	2	1	0
	Reserved (read only)	PS output	ALS Gain for ALS VIS and ALS IR				LED current	
		0 proximity output	0000	X1	X1		00 25 mA	
		1 Infrared DC level output	0100	X2	X1		01 50 mA	
			0101	X2	X2		10 100 mA	
			1010	X64	X64		11 200 mA	
			1110	X128	X64			
			1111	X128	X128			
			rest forbidden					

Persistence Register (0x43h)

Settings for the interrupt activation and of the persistence interrupt function. Persistence function is only valid for the PS measurements.

R/W-Register 0x43								
Bit	7	6	5	4	3	2	1	0
	Reserved (read only)			Persistence				
default	0000			0001 Interrupt status is updated after each measurement				

R/W-Register 0x43								
Bit	7	6	5	4	3	2	1	0
	Reserved (read only)				Persistence			
					0000 Interrupt becomes active after each measurement (The mode indicates that a PS or ALS measurement has been finished and can be read via the register. It is independent of the ALS & PS measurement value and threshold settings)			
					0001 Interrupt status is updated after each measurement (The interrupt status is updated independently after each measurement. <i>Active</i> or <i>Inactive</i> status of the interrupt is depending on the values of the last measurement in combination with the interrupt settings :“interrupt mode“ (register 0x4Ah) and „thresholds“ register 0c4Ch and following.)			
					0010 Interrupt status is updated if two consecutive threshold judgement are the same (The interrupt status only changes if the interrupt judgement of 2 consecutive measurement results are the same and different to the current interrupt status.)			
					0011 ... 1111 Interrupt status is updated if threshold judgement are the same over consecutive set times (3 .. 15) (This is the same procedure like in the 0010 persistence mode, but instead of 2 consecutive threshold judgments more are needed (3 to 15 depending on the setting) to change the interrupt status.) e.g.: 1010: 10 measurement results in a row need to fulfill the interrupt judgement to update the interrupt status			

PS_DATA_LSBs register (0x44h)

LSB of the PS output.

R-Register 0x44								
Bit	7	6	5	4	3	2	1	0
	2^7	2^6	2^5	2^4	2^3	2^2	2^1	2^0
default	0	0	0	0	0	0	0	0

PS_DATA_MSBs register (0x45h)

MSB of the PS output.

R-Register 0x45								
Bit	7	6	5	4	3	2	1	0
	not used	not used	not used	not used	2^{11}	2^{10}	2^9	2^8
default	0	0	0	0	0	0	0	0

ALS_VIS_DATA_LSBs register (0x46h)

LSB of the ALS VIS output.

R-Register 0x46								
Bit	7	6	5	4	3	2	1	0
	2^7	2^6	2^5	2^4	2^3	2^2	2^1	2^0
default	0	0	0	0	0	0	0	0

ALS_VIS_DATA_MSBs register (0x47h)

MSB of the ALS VIS output.

R-Register 0x47								
Bit	7	6	5	4	3	2	1	0
	2^{15}	2^{14}	2^{13}	2^{12}	2^{11}	2^{10}	2^9	2^8
default	0	0	0	0	0	0	0	0

ALS_IR_DATA_LSBs register (0x48h)

LSB of the ALS IR output.

R-Register 0x48								
Bit	7	6	5	4	3	2	1	0
	2^7	2^6	2^5	2^4	2^3	2^2	2^1	2^0
default	0	0	0	0	0	0	0	0

ALS_IR_DATA_MSBs register (0x49h)

MSB of the ALS IR output.

R-Register 0x49								
Bit	7	6	5	4	3	2	1	0
	2^{15}	2^{14}	2^{13}	2^{12}	2^{11}	2^{10}	2^9	2^8
default	0	0	0	0	0	0	0	0

Interrupt function setting register (0x4Ah)

Setting of the interrupt functions.

R/W-Register 0x4A								
Bit	7	6	5	4	3	2	1	0
	PS INT status (read only)	ALS INT status (read only)	PS INT mode		INT assert	INT latch	INT trigger	
default	0 inactive	0 inactive	00 PS_TH is only active		0 INT „L“ is stable	0 INT is latched	00 inactive	
	0 inactive	0 inactive	00 PS_TH (PS high threshold 0x4Bh & 0x4Ch) is only active		0 INT „L“ is stable if newer measurement results is also interrupt active	0 INT is latched until INT register is read or initialize	00 INT pin is inactive	
	1 active	1 active	01 PS_TH & PS_TL (PS high & low threshold) are active as hysteresis		1 INT „L“ is de-assert and re-assert if newer measurement results is also interrupt active	1 INT is updated after each measurement	01 triggered by PS only	
			10 PS_TH & PS_TL (PS high & low threshold) are active as outside detection				10 triggered by ALS only	
			11 forbidden				11 triggered by PS or ALS	

PS INT and **ALS INT** status (bit <7;6>): Directly after reading the register the interrupt status for PS and ALS and the INT Pin of the sensor is automatically set back to inactive status independent on the measurement results.

PS INT mode (bit <5;4>): The INT modes are only valid for the PS interrupt function. For description please see extra chapter „**PS INT Modes**“ (at the end of the register chapter).

INT assert (bit <3>): Is used to adjust the sensor behaviour to the used micro controller trigger settings. In case a repeated trigger in low state is needed the **INT assert** can be set to 1.

INT trigger (bit <2>): defines the source / sources for the interrupt.

INT latched (bit <1>): In latched mode the interrupt status stays active after the first activation. It is only released by reading the status are performing an interrupt reset.

PS_TH_LSBs register (0x4Bh)

LSB for the PS threshold „HIGH“.

R/W-Register 0x4B								
Bit	7	6	5	4	3	2	1	0
	2 ⁷	2 ⁶	2 ⁵	2 ⁴	2 ³	2 ²	2 ¹	2 ⁰
default	1	1	1	1	1	1	1	1

PS_TH_MSBs register (0x4Ch)

MSB for the PS threshold „HIGH“.

R/W-Register 0x4C								
Bit	7	6	5	4	3	2	1	0
					2^{11}	2^{10}	2^9	2^8
default	0	0	0	0	1	1	1	1

PS_TL_LSBs register (0x4Dh)

LSB for the PS threshold „LOW“.

R/W-Register 0x4D								
Bit	7	6	5	4	3	2	1	0
	2^7	2^6	2^5	2^4	2^3	2^2	2^1	2^0
default	0	0	0	0	0	0	0	0

PS_TL_MSBs register (0x4Eh)

MSB for the PS threshold „LOW“.

R/W-Register 0x4E								
Bit	7	6	5	4	3	2	1	0
					2^{11}	2^{10}	2^9	2^8
default	0	0	0	0	0	0	0	0

ALS_VIS_TH_LSBs register (0x4Fh)

LSB for the ALS VIS threshold „HIGH“.

R/W-Register 0x4F								
Bit	7	6	5	4	3	2	1	0
	2^7	2^6	2^5	2^4	2^3	2^2	2^1	2^0
default	1	1	1	1	1	1	1	1

ALS_VIS_TH_MSBs register (0x50h)

MSB for the ALS VIS threshold „HIGH“.

R/W-Register 0x50								
Bit	7	6	5	4	3	2	1	0
	2^{15}	2^{14}	2^{13}	2^{12}	2^{11}	2^{10}	2^9	2^8
default	1	1	1	1	1	1	1	1

ALS_VIS_TL_LSBs register (0x51h)

LSB for the ALS VIS threshold „LOW“.

R/W-Register 0x51								
Bit	7	6	5	4	3	2	1	0
	2^7	2^6	2^5	2^4	2^3	2^2	2^1	2^0
default	0	0	0	0	0	0	0	0

ALS_VIS_TL_MSBs register (0x52h)

MSB for the ALS VIS threshold „LOW“.

R/W-Register 0x52								
Bit	7	6	5	4	3	2	1	0
	2^{15}	2^{14}	2^{13}	2^{12}	2^{11}	2^{10}	2^9	2^8
default	0	0	0	0	0	0	0	0

INT modes

The Interrupt function compares ALS and PS measurement values with the current interrupt threshold level. PS and ALS VIS Interrupt status is readable via register 0x4Ah or at the INT pin of the sensor.

The Interrupt persistence function is only valid for PS measurements and is defined at register (0x43h). The INT pin of the SFH 7776 is an open drain output and should be pulled-up to V_{IO} by an external resistor. When VDD is supplied to the sensor the INT pin is per default in high ohmic (inactive) state. The INT status becomes inactive by writing an INT reset command, reading the INT status register or performing a software reset.

The INT status stays in its last state when the sensor is set to the standby mode. In the INT active state „low“ the sensor consumes ~25µA extra current. Therefore OSRAM recommends to set the INT state to high impedance before setting the sensor in standby mode.

Below the ALS and PS INT modes are described for the unlatched mode. In latched mode the switching back to the „inactive“ INT state is depending on an interrupt reset or on reading out the INT status register.

ALS INT mode:

The ALS VIS threshold levels high (register 0x4Fh & 0x50h) and low (register 0x4Fh & 0x50h) are only valid for the ALS VIS measurement values. The ALS VIS INT mode is fixed and can not be adapted via register. The thresholds define a window with the following functionality:

ALS INT is active, if the ALS VIS measurement values are outside the window

ALS INT is inactive, if the ALS VIS measurement results are inside the window.

PS INT Modes: Bit <5;4> of interrupt function setting register (0x4Ah)**00 PS_TH is active only:**

The INT state is active, if the PS measurement result is equal or higher than the set PS_TH high threshold.

The INT state is inactive, if the PS measurement result is lower than the set PS_TH high threshold.

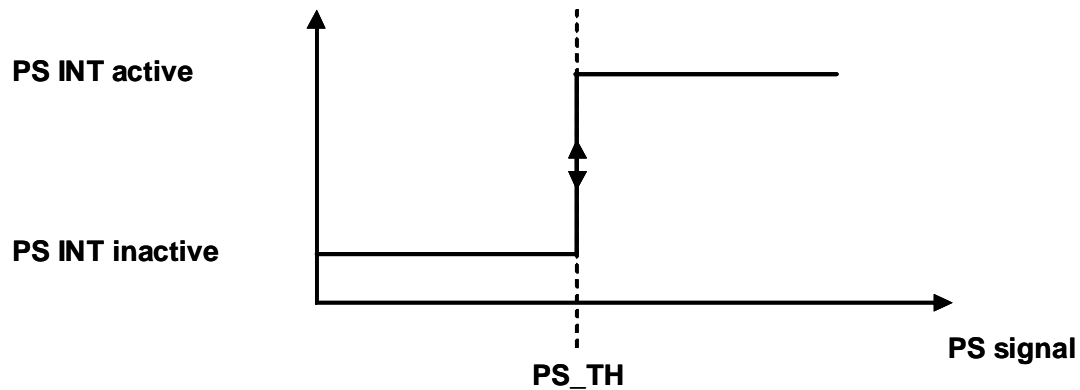

01 PS_TH & PS_TL (PS high & low threshold) are active as hysteresis:

PS_TH and PS_TL are working as a hysteresis. If the PS measurement signal is higher than the PS high threshold (PS_TH) the INT state is switched to active. If the PS measurement signal is lower than the PS low threshold (PS_TL) the INT state is inactive. If once the interrupt signal becomes active, the INT status is kept active until the measurement result becomes less than the PS_TL register value.

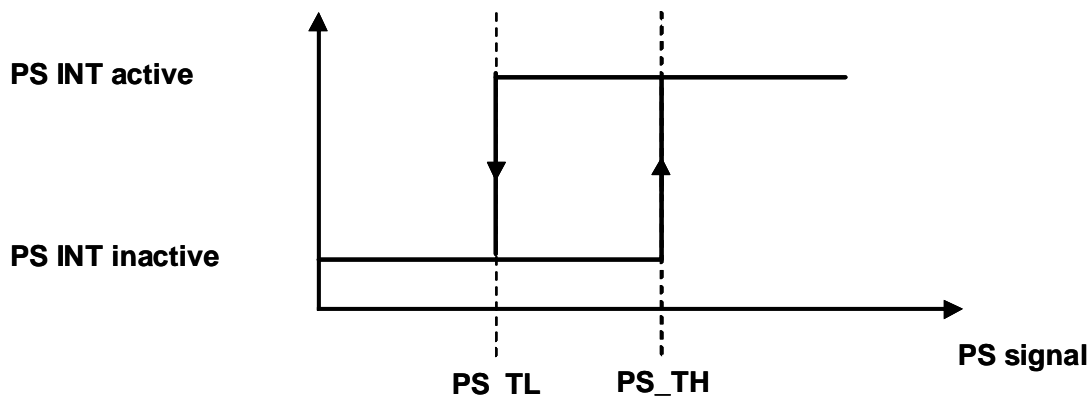

10 PS_TH & PS_TL (PS high & low threshold) are active as outside detection:

In case of "PS outside detection" mode interrupt signal inactive means that the measurement result is within the registered threshold level and the interrupt signal active means that the measurement result is out of registered threshold level.

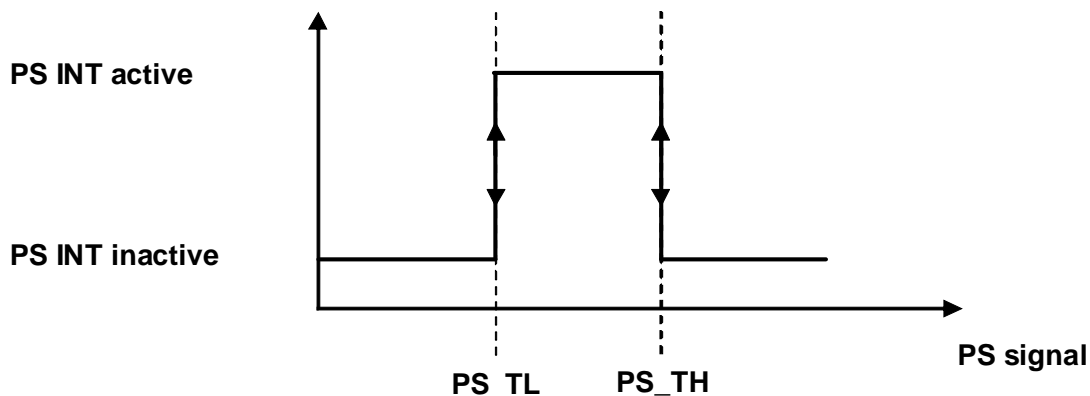

Package Outline

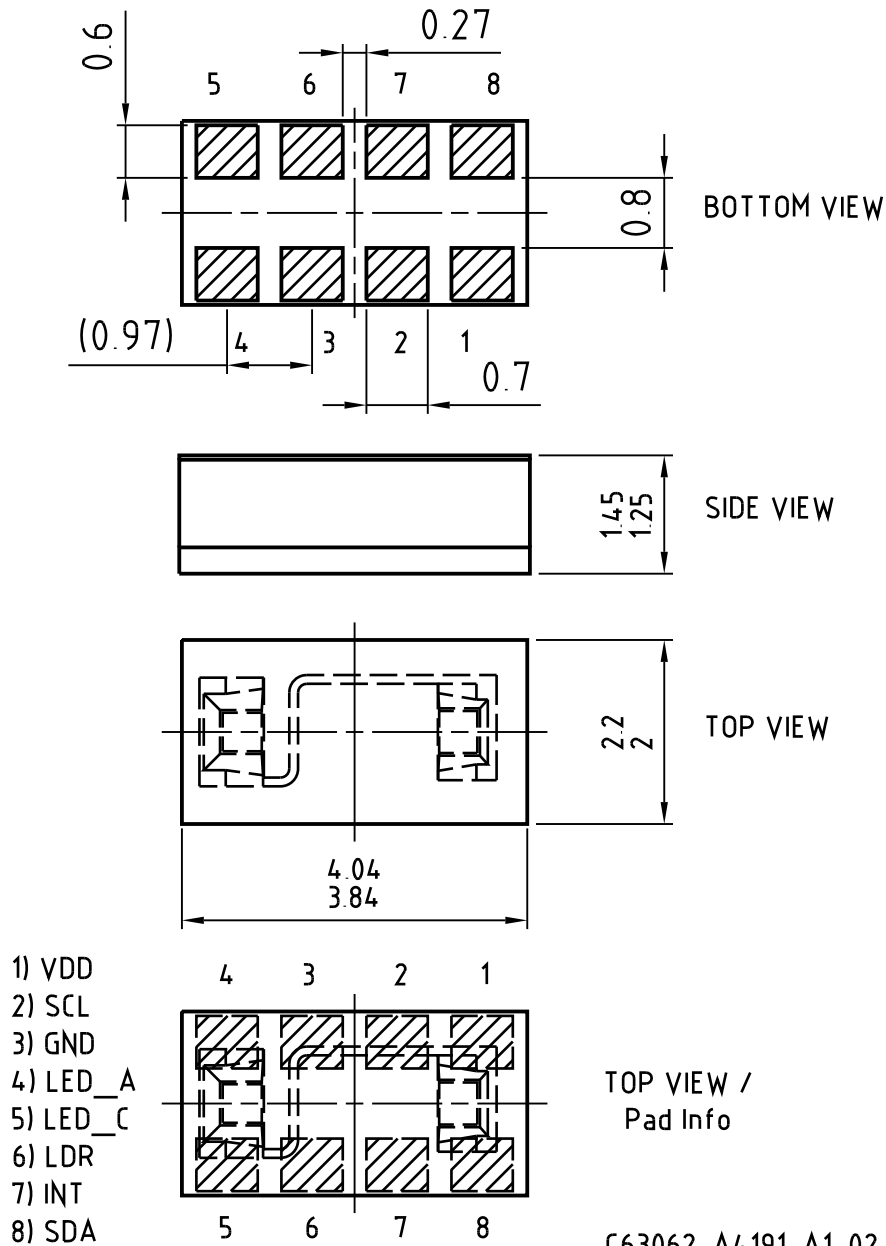

Dimensions in mm / Maße in mm.

The emitter is located in the cavity between pad 4 and 5. The orientation of the sensor can be detected by the asymmetrical channel on the sensor top side. For optical aperture design please see page 8.

Package

Chip on board

Method of Taping

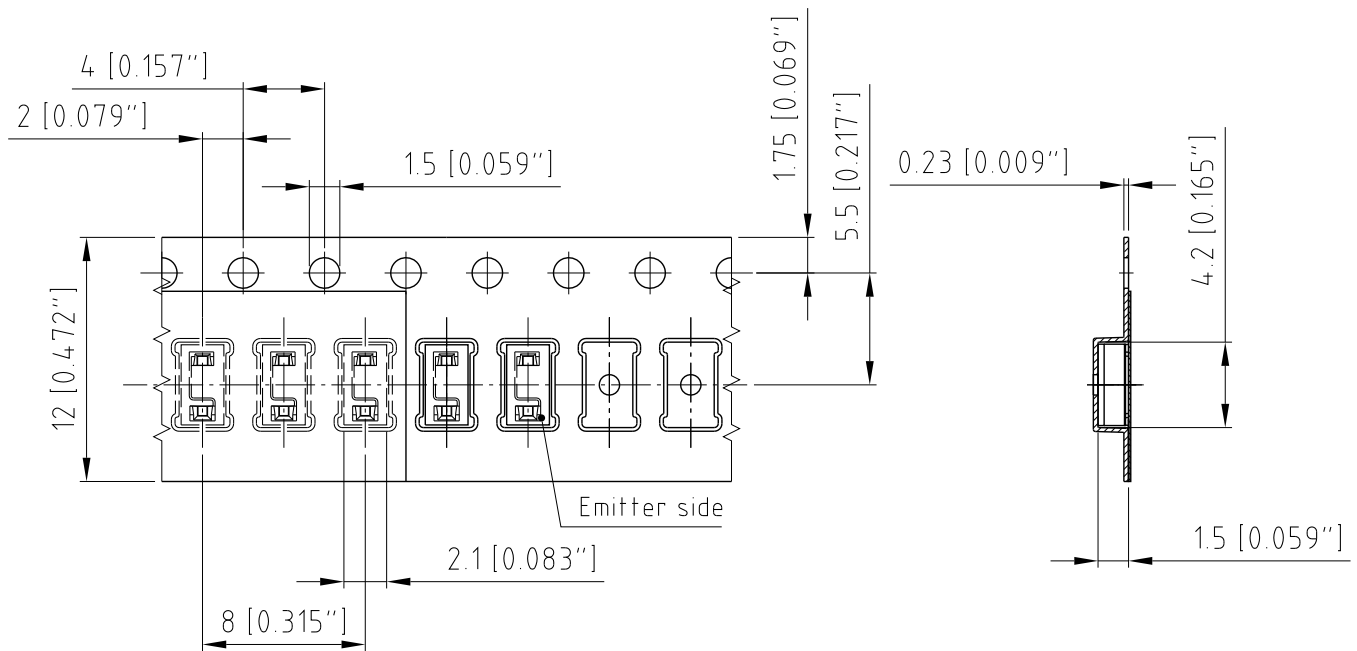

C63062-A4191-B6 -01

Dimensions in mm (inch). / Maße in mm (inch).

Recommended solder pad design

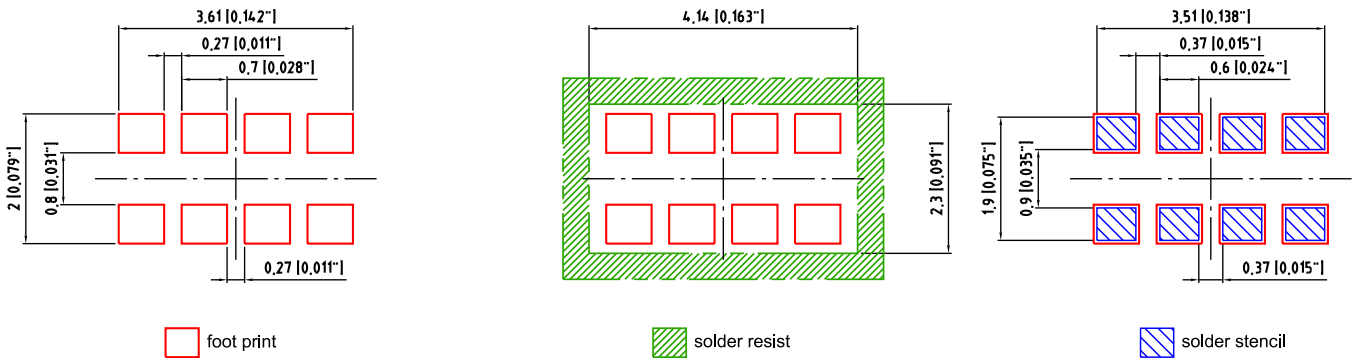

Component Location on Pad

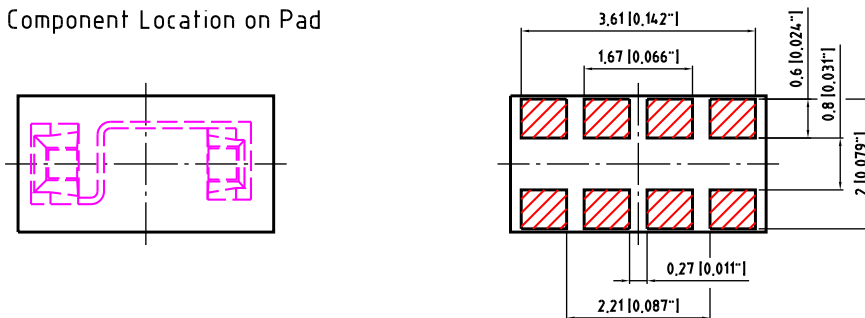

E062.3010.147-01

Dimensions in mm (inch). / Maße in mm (inch).

Cleaning / Washing

In general, OSRAM Opto Semiconductors does not recommend a wet cleaning process for the components **SFH7776** as the package is not hermetically sealed. Due to the open design, all kind of cleaning liquids can infiltrate the package and cause a degradation or a complete failure of the LED or ASIC. It is also recommended to prevent penetration of organic substances from the environment which could interact with the hot surfaces of the operating chips. Ultrasonic cleaning is generally not recommended for all types of LEDs (see also the application note "Cleaning of LEDs"). As is standard for the electronic industry, OSRAM Opto Semiconductors recommends using low-residue or no-clean solder paste, so that PCB cleaning after soldering is no longer required. In any case, all materials and methods should be tested beforehand in order to determine whether the component will be damaged in the process.

Reflow Soldering Profile

Preconditioning: JEDEC Level 3 acc. to JEDEC S-STD-020-D

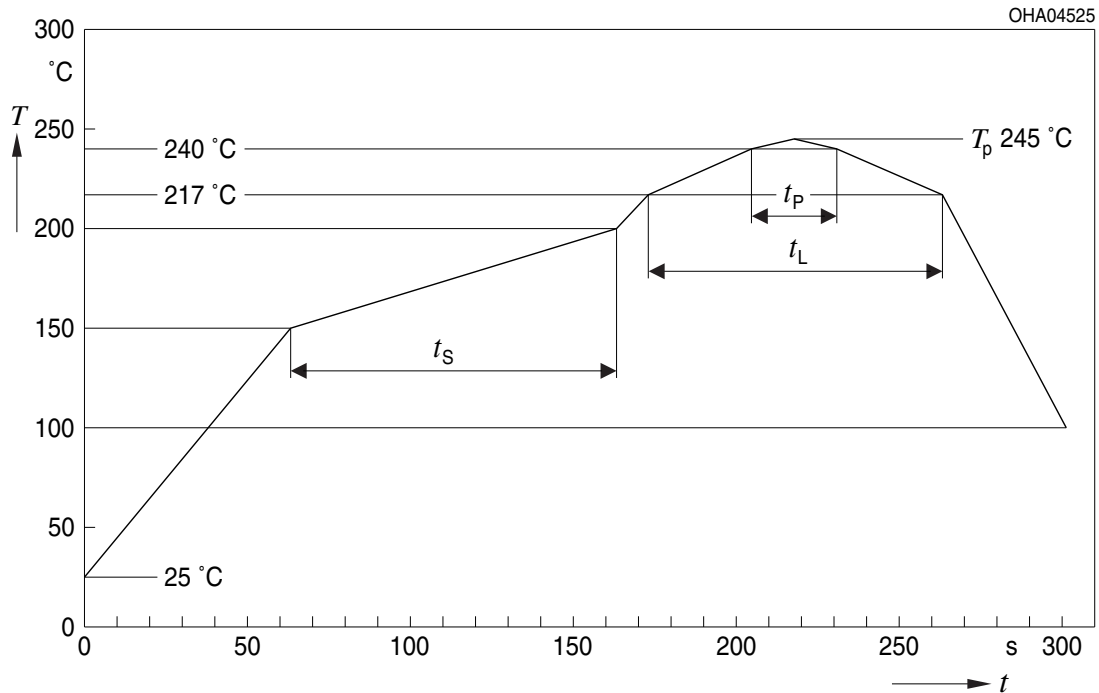

OHA04612

Profile Feature Profil-Charakteristik	Symbol Symbol	Pb-Free (SnAgCu) Assembly			Unit Einheit
		Minimum	Recommendation	Maximum	
Ramp-up rate to preheat*) 25 °C to 150 °C			2	3	K/s
Time t_S T_{Smin} to T_{Smax}	t_S	60	100	120	s
Ramp-up rate to peak*) T_{Smax} to T_P			2	3	K/s
Liquidus temperature	T_L	217			°C
Time above liquidus temperature	t_L		80	100	s
Peak temperature	T_P		245	260	°C
Time within 5 °C of the specified peak temperature $T_P - 5$ K	t_P	10	20	30	s
Ramp-down rate* T_P to 100 °C			3	6	K/s
Time 25 °C to T_P				480	s

All temperatures refer to the center of the package, measured on the top of the component

* slope calculation DT/Dt : Dt max. 5 s; fulfillment for the whole T-range

Disclaimer

OSRAM OS assumes no liability whatsoever for any use of this document or its content by recipient including, but not limited to, for any design in activities based on this preliminary draft version. OSRAM OS may e.g. decide at its sole discretion to stop developing and/or finalizing the underlying design at any time.

Attention please!

The information describes the type of component and shall not be considered as assured characteristics.

Terms of delivery and rights to change design reserved. Due to technical requirements components may contain dangerous substances.

For information on the types in question please contact our Sales Organization. If printed or downloaded, please find the latest version in the Internet.

Packing

Please use the recycling operators known to you. We can also help you – get in touch with your nearest sales office. By agreement we will take packing material back, if it is sorted. You must bear the costs of transport. For packing material that is returned to us unsorted or which we are not obliged to accept, we shall have to invoice you for any costs incurred.

Components used in life-support devices or systems must be expressly authorized for such purpose!

Critical components* may only be used in life-support devices** or systems with the express written approval of OSRAM OS.

*) A critical component is a component used in a life-support device or system whose failure can reasonably be expected to cause the failure of that life-support device or system, or to affect its safety or the effectiveness of that device or system.

**) Life support devices or systems are intended (a) to be implanted in the human body, or (b) to support and/or maintain and sustain human life. If they fail, it is reasonable to assume that the health and the life of the user may be endangered.

Disclaimer

OSRAM OS übernimmt keine wie auch immer geartete Haftung für die Nutzung dieses Dokuments und seines Inhaltes durch den Empfänger, insbesondere nicht für irgendwelche Design-Aktivitäten, die auf dieser vorläufigen Entwurfsversion basieren. OSRAM OS behält sich beispielsweise auch vor, jederzeit die Weiter- und Fertigungsentwicklung des zugrundeliegenden Designs einseitig einzustellen.

Bitte beachten!

Lieferbedingungen und Änderungen im Design vorbehalten. Aufgrund technischer Anforderungen können die Bauteile Gefahrstoffe enthalten. Für weitere Informationen zu gewünschten Bauteilen, wenden Sie sich bitte an unseren Vertrieb. Falls Sie dieses Datenblatt ausgedruckt oder heruntergeladen haben, finden Sie die aktuellste Version im Internet.

Verpackung

Benutzen Sie bitte die Ihnen bekannten Recyclingwege. Wenn diese nicht bekannt sein sollten, wenden Sie sich bitte an das nächstgelegene Vertriebsbüro. Wir nehmen das Verpackungsmaterial zurück, falls dies vereinbart wurde und das Material sortiert ist. Sie tragen die Transportkosten. Für Verpackungsmaterial, das unsortiert an uns zurückgeschickt wird oder das wir nicht annehmen müssen, stellen wir Ihnen die anfallenden Kosten in Rechnung.

Bauteile, die in lebenserhaltenden Apparaten und Systemen eingesetzt werden, müssen für diese Zwecke ausdrücklich zugelassen sein!

Kritische Bauteile* dürfen in lebenserhaltenden Apparaten und Systemen** nur dann eingesetzt werden, wenn ein schriftliches Einverständnis von OSRAM OS vorliegt.

*) Ein kritisches Bauteil ist ein Bauteil, das in lebenserhaltenden Apparaten oder Systemen eingesetzt wird und dessen Defekt voraussichtlich zu einer Fehlfunktion dieses lebenserhaltenden Apparates oder Systems führen wird oder die Sicherheit oder Effektivität dieses Apparates oder Systems beeinträchtigt.

**) Lebenserhaltende Apparate oder Systeme sind für (a) die Implantierung in den menschlichen Körper oder (b) für die Lebenserhaltung bestimmt. Falls Sie versagen, kann davon ausgegangen werden, dass die Gesundheit und das Leben des Patienten in Gefahr ist.

Published by OSRAM Opto Semiconductors GmbH
Leibnizstraße 4, D-93055 Regensburg
www.osram-os.com © All Rights Reserved.

EU RoHS and China RoHS compliant product



此产品符合欧盟 RoHS 指令的要求；
按照中国的相关法规和标准，不含有毒有害物质或元素。