

# **AEH Half-brick Product**

## **Technical Reference Notes**

**48V Input, 1.5V@30A Output**

**High Efficiency DC-DC Converter**

**(REV01)**



## Introduction

AEH30M48(N) single output product comes with a 2:1 input range of 36V-75V, isolated outputs 1.5V/30A. Standard features include input low voltage protection(LVP), output over-voltage protection(OVP), over-current protection(OCP), over-temperature protection(OTP), CNT, Trim, and remote sense functions. The input-output isolation is 1500Vdc, and it can operate up to 100°C(base-plate temperature) without derating. AEH30M48(N) single output isolated DC/DC converters are built using the industry standard half-brick pin-out and package: 61.0mm x 57.9mm x 12.7mm (**2.4" x 2.28" x 0.5"**). Typical efficiencies are 78% for the 1.5V@30A output.

The AEH30M48(N) single output is designed to meet CISPR22, EN55022, UL, TUV, and CSA certifications. Designed for high reliability, the converters use high quality components, 100% surface mount technology and manufactured in ISO9001 facilities.

## Design Features

- ☞ High Efficiency
- ☞ High power density
- ☞ Low output noise
- ☞ Metal base-plate
- ☞ CNT function
- ☞ Trim function
- ☞ Remote sense
- ☞ Input under-voltage protection
- ☞ Output short circuit protection
- ☞ Output current limiting
- ☞ Output over-voltage protection
- ☞ Over-temperature protection
- ☞ High input-output isolation voltage

## Options

- ☞ Heat sink available for extended operation.
- ☞ Choice of CNT logic configuration.

## Typical Application

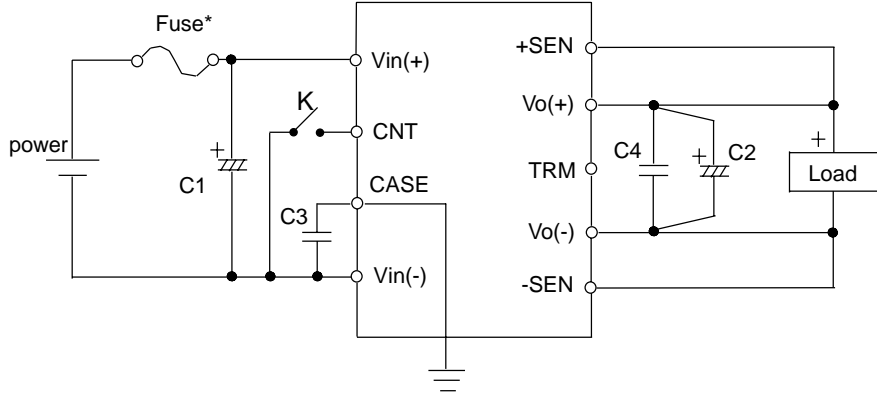

**NOTE:** The figure is Negative Logic Control, if the CNT pin is left open, the converter will default to 'control off' operation. Positive Logic Control is also available.

Positive Logic Control: Low=Off, High=On.

Negative Logic Control: Low=On, High=Off.

### Recommended External components:

Fuse\*: Recommended: 3A.

C1: Recommended 100 $\mu$ F/100V (use two parallel at -40 °C).

C2: Recommended electrolytic capacitor of 2200 $\mu$ F /16V(Low ESR).

C3: Recommended 4700pF/2000V

C4: Recommended metallic film capacitor of 1 $\mu$ F /16V.

## Block Diagram

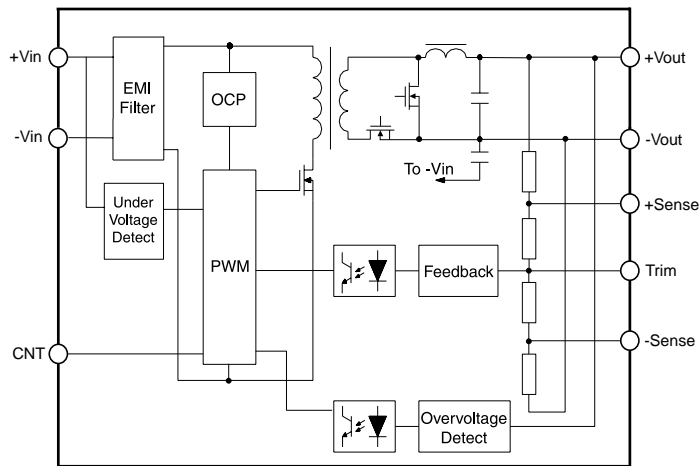

**AEH High Efficiency Series Half-Brick Power Converters**  
**36VDC to 75VDC Input, 1.5V@30A Output**

---

## ***Ordering Information***

| <b>Model</b>       | <b>Input Voltage (V)</b> | <b>Output Voltage (V)</b> | <b>Output Current (A)</b> | <b>Ripple&amp;Noise (mV pp)</b> | <b>Efficiency (%) Min</b> | <b>Short-circuit Current (A)</b> | <b>Over-voltage Lockout (V)</b> |
|--------------------|--------------------------|---------------------------|---------------------------|---------------------------------|---------------------------|----------------------------------|---------------------------------|
| <b>AEH30M48(N)</b> | <b>36-75</b>             | <b>1.5</b>                | <b>30</b>                 | <b>60&amp;100</b>               | <b>76</b>                 | <b>33-39</b>                     | <b>1.8-2.3</b>                  |

---

**USA**

**TEL:** 1-760-930-4600  
**FAX:** 1-760-930-0698

**Europe**

44-(0)1384-842-211  
44-(0)1384-843-355

**Asia**

852-2437-9662  
852-2402-4426

[www.astec.com](http://www.astec.com)



## Electrical Characteristic

### Absolute Maximum Rating

| Parameters                    | Min. | Typ. | Max. | Unit | Note         |
|-------------------------------|------|------|------|------|--------------|
| Input voltage (+Vin ~ -Vin)   | -0.3 | -    | 80   | Vdc  | Continuously |
| CNT voltage (CNT ~ -Vin)      | -0.7 | -    | 15   | Vdc  | Continuously |
| Isolated voltage              | -    | -    | 1500 | Vdc  | Input-output |
| Operating ambient temperature | -40  | -    | +100 | °C   |              |
| Storage temperature           | -40  | -    | +125 | °C   |              |

### Input characteristics

| Parameter                    | Code | Min. | Typ. | Max. | Unit              | Conditions   |
|------------------------------|------|------|------|------|-------------------|--|
| Input voltage range          | Vin  | 36   | 48   | 75   | Vdc               |  |
| Maximum input current        | Iin  | -    | -    | 2    | A                 | (the lowest input voltage, rated output )                  |
| Input under-voltage shutdown | -    | 30   | 33   | 35   | Vdc               |  |
| Input reflected current      | -    | -    | -    | 30   | mA <sub>p-p</sub> | ( 5Hz-20MHz, 12μH impedance, ambient temperature Ta=25°C ) |

### General Specification

| Parameter | Code | Min.    | Typ. | Max. | Unit | Conditions |
|-----------|------|---------|------|------|------|------------|
| MTBF      | -    | 2000000 | -    | -    | hour |            |
| Weight    | -    | -       | 70   | -    | g    |            |

### CNT Function

| Parameter       | Code | Min. | Typ. | Max. | Unit | Conditions |
|-----------------|------|------|------|------|------|------------|
| Logic High      | -    | 3.5  | -    | 15   | V    |            |
| Logic Low       | -    | -0.7 | -    | 1.2  | V    |            |
| Control Current | -    | -    | -    | 1    | mA   | Logic Low  |

### CNT characteristics

| Parameter                                       | Code   | Min. | Typ. | Max. | Unit | Conditions                                 |
|---|--------|------|------|------|------|--|
| CNT is set on, input voltage sudden change (ON) | Tdelay | -    | -    | 10   | ms   | (80% rated load, ambient temperature 25°C) |
| Output voltage rise time                        | Trise  | -    | 10   | 20   | ms   |  |
| Output voltage rush over                        | Trush  | -    | 0    | -    | %Vo  |  |

**AEH High Efficiency Series Half-Brick Power Converters**  
**36VDC to 75VDC Input, 1.5V@30A Output**

**Output Characteristics**

| Parameter                        | Code   | Min.  | Typ.  | Max.  | Unit   | Conditions   |
|----------------------------------|--------|-------|-------|-------|--------|--|
| Output setpoint voltage          | Vo,set | 1.480 | 1.500 | 1.520 | Vdc    | 25°C ambient temperature, rated input, full load   |
| Output voltage                   | Vo     | 1.480 | 1.500 | 1.520 | Vdc    | Full input range, output range and ambient temperature range. 0~100% load                        |
| Line regulation                  | -      | -     | 0.1   | 0.2   | %      | Low-high   |
| Load regulation                  | -      | -     | 0.1   | 0.5   | %      | 0~100% rated load (+Io=-Io)  |
| Temperature coefficient          | Tcoeff | -     | -     | 0.02% | /°C    |  |
| Output ripple peak-peak value    | -      | -     | -     | 60    | mVp-p  |  |
| Output noise peak-peak value     | -      | -     | -     | 100   | mVp-p  | f<20MHz  |
| Output current                   | Io     | -     | -     | 30    | A      | (when Io>Iomax, the module can operate normally, but the ripple&noise may exceed the standards.) |
| Output current-limiting setpoint | -      | 33    | -     | 39    | A      | (Vo=90%Vo)   |
| Efficiency                       | η      | 76    | 78    | -     | -      | (rated input voltage, rated load, ambient temperature 25°C)                                      |
| Dynamic response Voltage inrush  | Vo,set | -     | -     | 80    | mV     | 25% Inom step, ΔIo/Δt=1A/10μs  |
| Response time                    | -      | -     | -     | 200   | μS     |  |
| Switching frequency              | -      | -     | 220   | -     | KHz    |  |
| Output voltage adjustable range  | -      | 80%   | -     | 110%  | Vo,set |  |
| Output over-voltage shutdown     | -      | 1.8   | -     | 2.3   | V      | +Vo~ -Vo   |

**Safety Characteristics**

| Parameter            | Code | Min. | Typ. | Max. | Unit |
|----------------------|------|------|------|------|------|
| Isolation voltage:   |      |      |      |      |      |
| Input - output       | -    | 1500 | -    | -    | Vdc  |
| Input - case         | -    | 1500 | -    | -    | Vdc  |
| Output - case        | -    | 1500 | -    | -    | Vdc  |
| Isolation resistance | -    | 10   | -    | -    | MΩ   |

## Characteristic Curves (at 25 °C)

**Reflected noise current testing With 12 $\mu$ H impedance, test point in the input line**

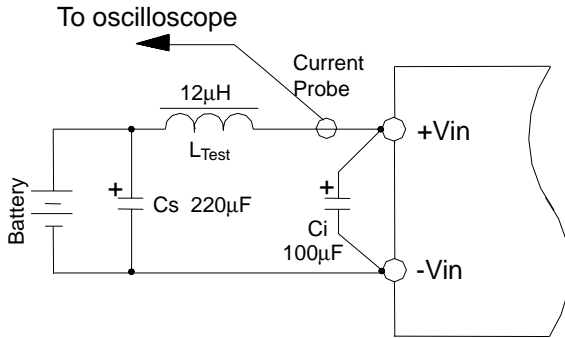

**Output ripple & noise testing method**

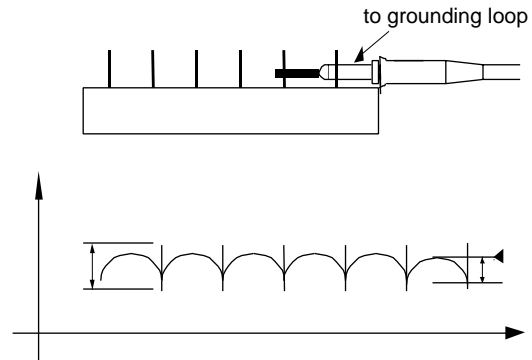

**Typical Efficiency AEH30M48N**

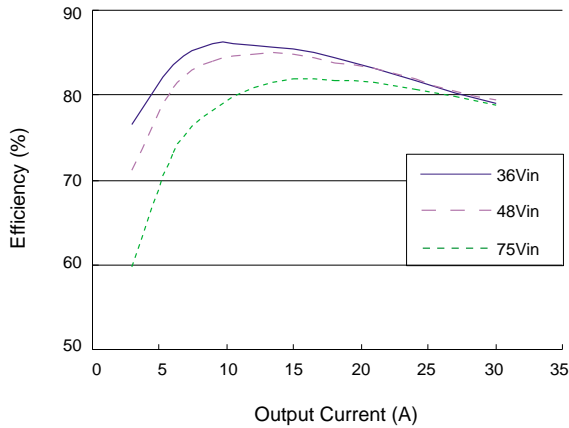

**Typical Input-Output Characteristics AEH30M48N**

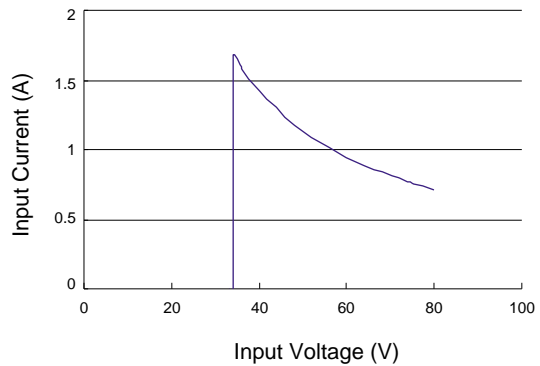

**Typical OCP AEH30M48N**

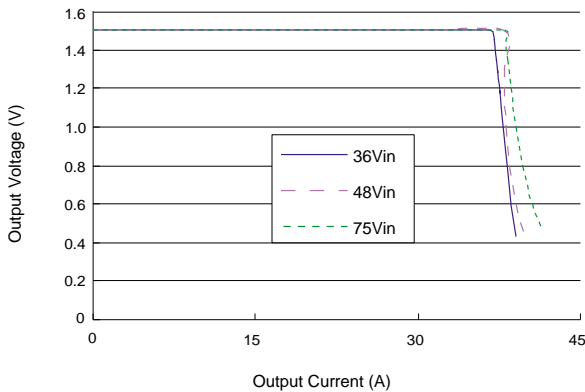

## ***Transient response*** (48V rated input voltage, full load, at 25 °C)

**Typical Start-Up Transient with CNT  
AEH30M48N**

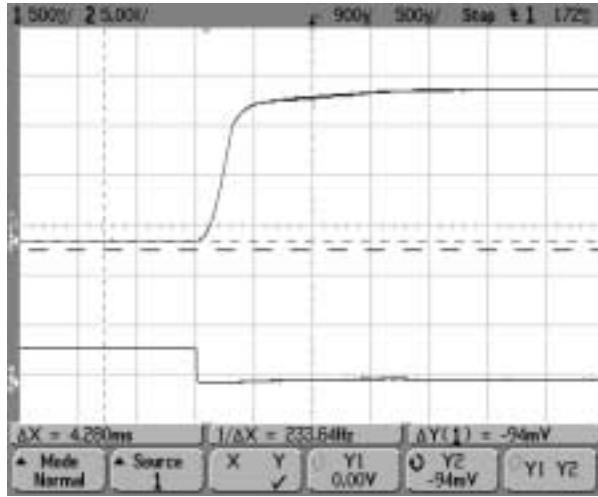

**Typical Shut-down Transient with CNT  
AEH30M48N**

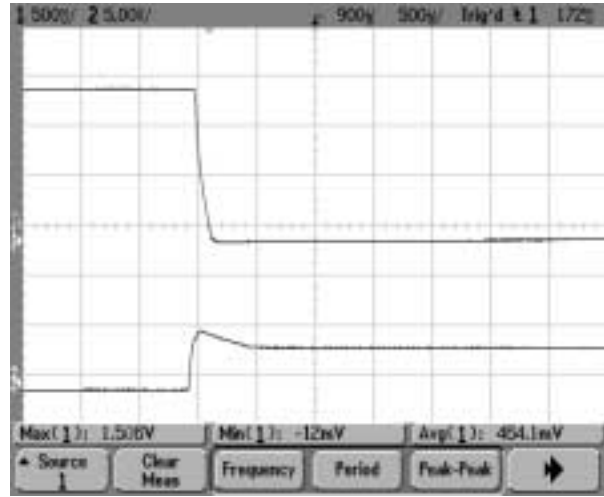

**Typical Start-up from Power On  
AEH30M48N**

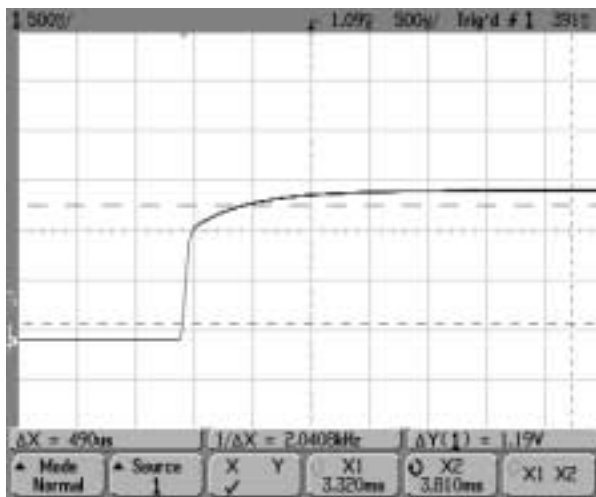

**Typical Shut-down from Power Off  
AEH30M48N**

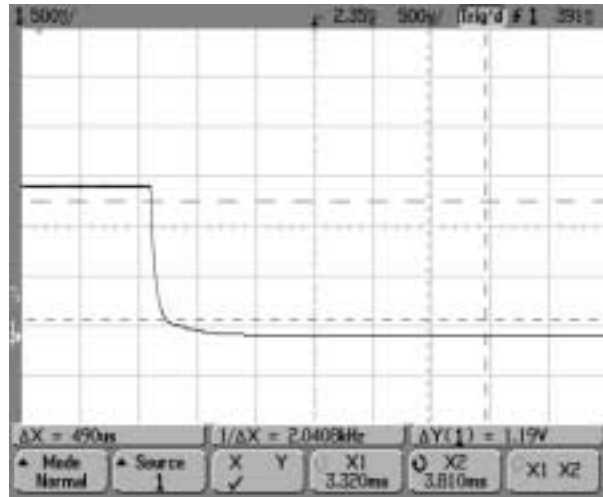



## Transient response (48V rated input voltage, full load, at 25 °C)

Typical Transient Response to Step Load  
 Change from 25%-50%-25%I<sub>omax</sub>  
 AEH30M48N

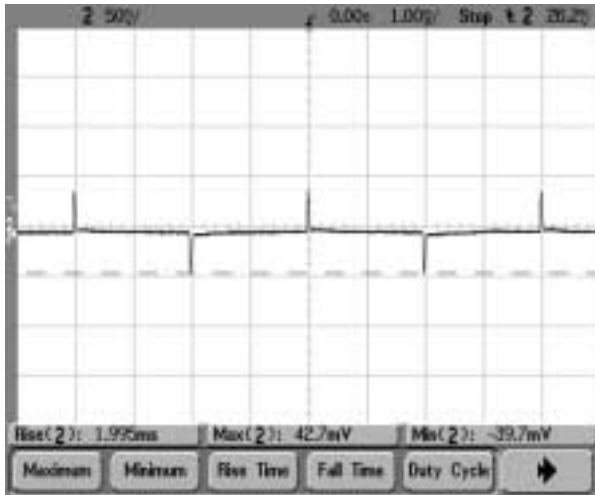

Typical Transient Response to Step Load  
 Change from 50%-75%-50%I<sub>omax</sub>  
 AEH30M48N

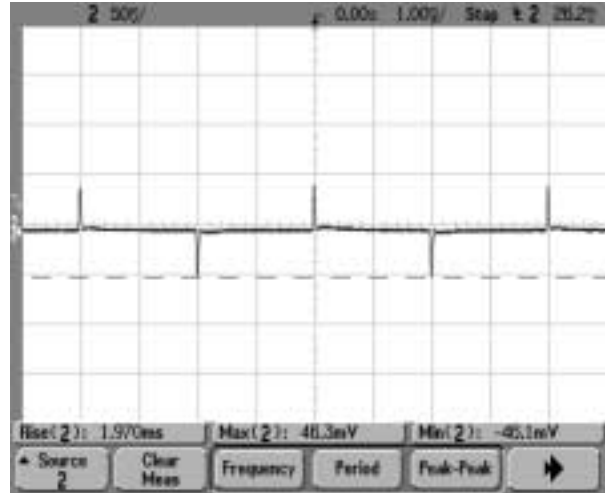

Typical Output Ripple Voltage  
 AEH30M48N

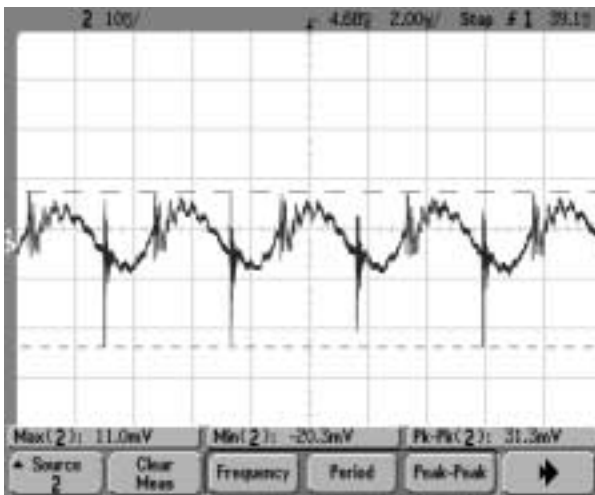

Typical Overvoltage Protection  
 AEH30M48N

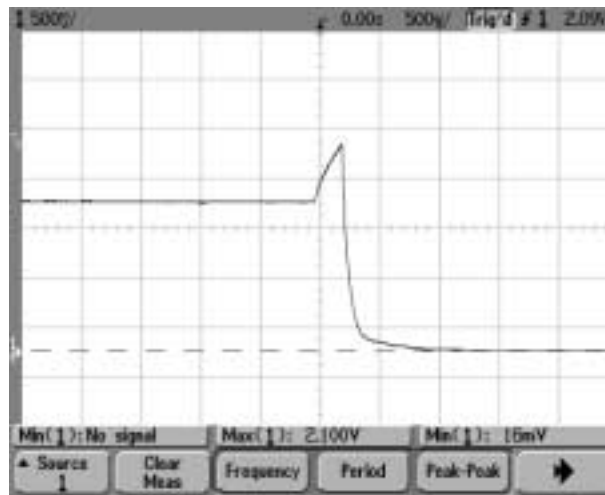

## Pin Location

The +Vin and -Vin input connection pins are located as shown in Figure 1. AEH30M48 converter has a 2:1 input voltage range and can accept input voltage range of 36-75 Vdc.

**Care should be taken to avoid applying reverse polarity to the input which can damage the converter.**

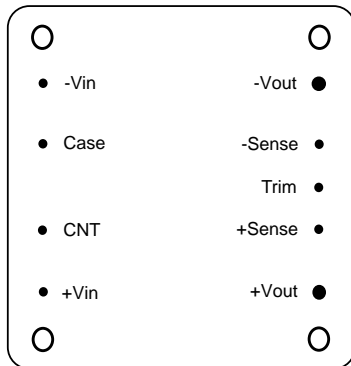

Component-side footprint

Fig.1 Pin Location

## Input Characteristic

### Fusing

The AEH30M48(N) power module has no internal fuse. An external fuse must always be employed! To meet international safety requirements, a 250 Volt rated fuse should be used. If one of the input lines is connected to chassis ground, then the fuse must be placed in the other input line.

Standard safety agency regulations require input fusing. Recommended fuse ratings for the AEH30M48(N) is 3A.

### Input Reverse Voltage Protection

Under installation and cabling conditions where reverse polarity across the input may occur, reverse polarity protection is recommended. Protection can easily be provided as shown in Figure 2. In both cases the diode rating is determined by the power of the converter. Diodes should be rated at 3A/100V for AEH30M48(N). **Placing the diode across the inputs rather than in-line with the input offers an advantage in that the diode only conducts in a reverse polarity condition, which increases circuit efficiency and thermal performance.**

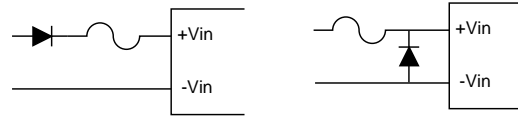

Fig.2 Reverse Polarity Protection Circuits

### Input Undervoltage Shutdown

The module has input under voltage protection. The AEH30M48(N) is protected against under-voltage on the input. If the input voltage drops below the acceptable range, the converter will shut down. It will automatically restart when the under-voltage condition is removed.

When the input voltage is below LVP point, the input under-voltage protection active, output is cut off. There is a 1-2V hysteresis between the under-voltage shutdown point and restart up point.

### Input Filter

Input filters are included in the converters to help achieve standard system emissions certifications. Some users however, may find that additional input filtering is necessary. The AEH30M48(N) has an internal switching frequency of 220 kHz so a high frequency capac-

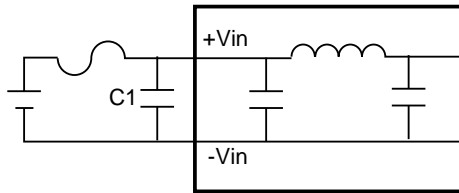

**Fig.3 Ripple Rejection Input Filter**

itor mounted close to the input terminals produces the best results. To reduce reflected noise, a capacitor can be added across the input as shown in Figure 3, forming a  $\pi$  filter. A  $100\mu\text{F}/100\text{V}$  electrolytic capacitor is recommended for C1.

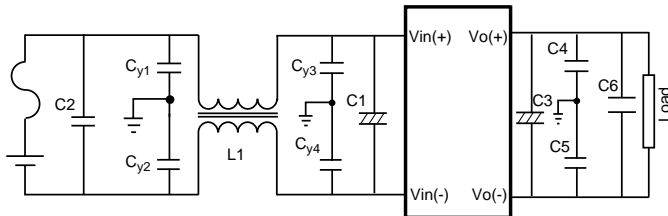

**Fig.4 EMI Reduction Input Filter**

For conditions where EMI is a concern, a different input filter can be used. Figure 4 shows a typical application circuit special designed to reduce EMI effects. Users can choose different capacitor value according to actual applications. C1 is recommended  $100\mu\text{F}/100\text{V}$ . The recommended value of C2 is a  $0.22\mu\text{F}/100\text{V}$  safety capacitor, Cy1 and Cy2 are each  $4700\text{pF}/250\text{V}$  safety capacitor. Cy3 and Cy4 are each  $0.022\mu\text{F}/275\text{V}$  safety capacitor. C3 is  $2200\mu\text{F}/16\text{V}$ . C4 and C5 is  $4700\text{pF}/250\text{V}$  safety capacitor. C6 is  $0.1\mu\text{F}/100\text{V}$  ceramic capacitor. L1 is a  $6\text{mH}$  common mode choke.

When a filter inductor is connected in series with the power converter input, an input capacitor C1 should be added. An input capacitor C1 should also be used when the input wiring is long, since the wiring can act as an inductor. Failure to use an input capacitor under these conditions can produce large input voltage

spikes and an unstable output.

**Control Function**

Two CNT options are available.

**For Negative logic:** applying a voltage less than  $1.2\text{V}$  to the CNT pin will enable the output, and applying a voltage greater than  $3.5\text{V}$  will disable it.

**For Positive logic:** applying a voltage larger than  $3.5\text{V}$  to the CNT pin will enable the output, and applying a voltage less than  $1.2\text{V}$  will disable it.

Positive logic, device code suffix " P ". Negative logic, device code suffix nothing is the factory-preferred.

**If the CNT pin is left open, the converter will default to " control off " operation in negative logic, but default to " control on " in positive logic.**

The maximum voltage that can be applied to the CNT pin is  $15\text{V}$ . If the CNT function is not used: negative logic --- connect CNT pin to  $V_{in(-)}$ , positive logic --- leave CNT pin open.

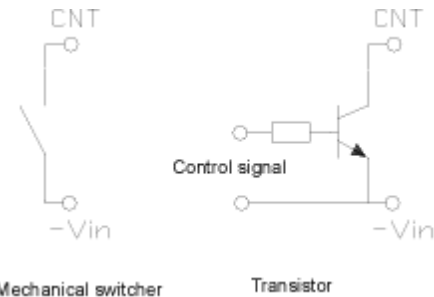

**Fig.5 Non-isolated CNT Control**

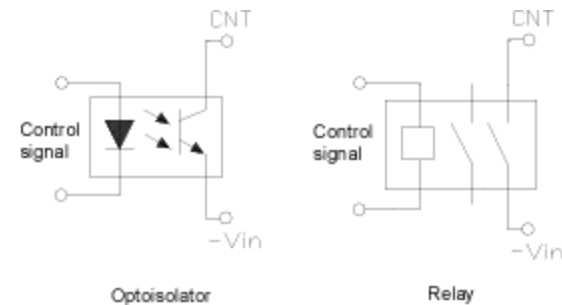

**Fig.6 Isolated CNT Control**

During operation, the working current of CNT is related to its input voltage, and is lower than 1mA.

In the non-isolated application, CNT control can be realized through mechanical switcher or transistor as Figure 5.

In the isolated application, CNT control can be realized through optoisolator or relay as Fig. 6. It is recommended to parallel a 0.1 $\mu$ F capacitor to remove the interference when the CNT line is too long.

## Input-Output Characteristic

### Safety Consideration

For safety-agency approval of the system in which the power module is used, the power module must be installed in compliance with the spacing and separation requirements of the end-use safety agency standard, i.e., UL1950, CSA C22.2 No. 950-95, and EN60950. The input-to-output 1500VDC isolation is an operational insulation. The DC/DC power module should be installed in end-use equipment, in compliance with the requirements of the ultimate application, and is intended to be supplied by an isolated secondary circuit. When the supply to the DC/DC power module meets all the requirements for SELV(<60Vdc), the output is considered to remain within SELV limits (level 3). If connected to a 60Vdc power system, double or reinforced insulation must be provided in the power supply that isolates the input from any hazardous voltages, including the ac mains. One Vi pin and one Vo pin are to be grounded or both the input and output pins are to be kept floating. Single fault testing in the power supply must be performed in combination with the DC/DC power module to demonstrate that the output meets the requirement for

SELV. The input pins of the module are not operator accessible.

**Note:** Do not ground either of the input pins of the module, without grounding one of the output pins. This may allow a non-SELV voltage to appear between the output pin and ground.

### Case Grounding

For proper operation of the module, the case or baseplate of the AEH30M48(N) does not require a connection to a chassis ground. If the AEH30M48(N) is not in a metallic enclosure in a system, it may be advisable to directly ground the case to reduce electric field emissions. Leaving the case floating can help to reduce magnetic field radiation from common mode noise currents. If the case has to be grounded for safety or other reasons, an inductor can be connected to chassis at DC and AC line frequencies, but be left floating at switching frequencies. Under this condition, the safety requirements are met and the emissions are minimized.

## Output Characteristics

### Minimum Load Requirement

There is no minimum load requirement for the AEH30M48(N).

### Remote Sensing

The AEH30M48(N) can remotely sense both lines of its output which moves the effective output voltage regulation point from the output of the unit to the point of connection of the remote sense pins. This feature automatically adjusts the real output voltage of the AEH30M48(N) in order to compensate for voltage drops in distribution and maintain a regulated voltage at the point of load.

**AEH High Efficiency Series Half-Brick Power Converters**  
**36VDC to 75VDC Input, 1.5V@30A Output**

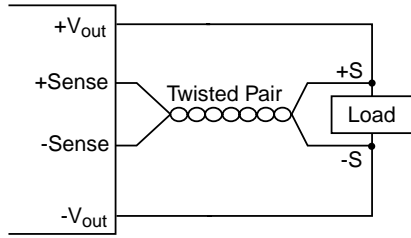

**Fig.7 Sense Connections**

When the converter is supporting loads far away, or is used with undersized cabling, significant voltage drop can occur at the load. The best defense against such drops is to locate the load close to the converter and to ensure adequately sized cabling is used. When this is not possible, the converter can compensate for a drop of up to 0.5V, through use of the sense leads.

When used, the +SEN and -SEN leads should be connected from the converter to the point of load as shown in Figure 7 using twisted pair wire. The converter will then regulate its output voltage at the point where the leads are connected. Care should be taken not to reverse the sense leads. If reversed, the converter will trigger OVP protection and turn off. When not used, the +SEN lead must be connected with +Vo, and -SEN with -Vo. Also note that the output voltage and the remote sense voltage offset must be less than the minimum overvoltage trip point. **Note that at elevated output voltages the maximum power rating of the module remains the same, and the output current capability will decrease correspondingly.**

**Trim**

Users can increase or decrease the output voltage set point of a module by connecting an external resistor between the TRIM pin and either the +SEN or -SEN pins. The trim resistor should be positioned close to the module. **If not**

**using the trim feature, leave the TRIM pin open.**

Trimming up by more than 10% of the nominal output may damage the converter or trig the OVP protection. Trimming down more than 20% can cause the converter to regulate improperly. Trim down and trim up circuits and the corresponding configuration are shown in Figure 8 to Figure 11.

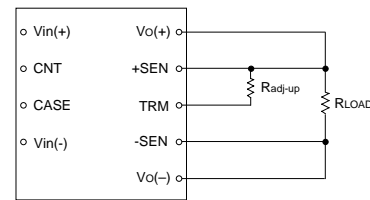

$$R_{adj-up} = \frac{21}{y} - 1.5$$

y is the adjusting percentage of the voltage.  
 0 < y ≤ 10  
 Radj-up is in kΩ.  
 Vo is rated output voltage.

**Fig.8 Equation to Trim Up Output Voltage**

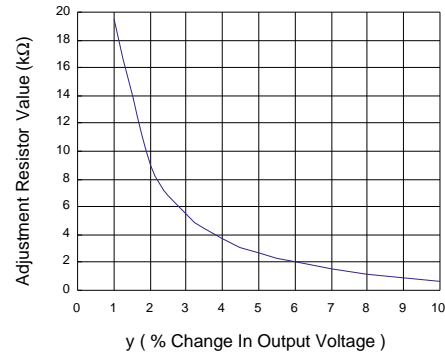

**Fig.9 Resistor Selection for Trimming Up**

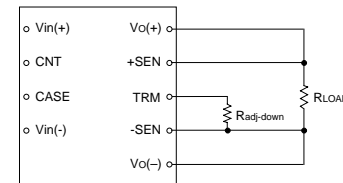

$$R_{adj-down} = \frac{100}{y} - 1.51$$

y is the adjusting percentage of the voltage.  
 0 < y ≤ 20  
 Radj-up is in kΩ.  
 Vo is rated output voltage.

**Fig.10 Equation to Trim Down Output Voltage**

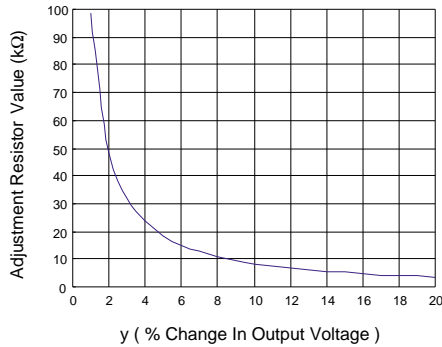

**Fig.11 Resistor Selection for Trimming Down**

**Note that at elevated output voltages the maximum power rating of the module remains the same, and the output current capability will decrease correspondingly.**

Trimming up the output voltage, the output power should not exceed its rated output power.

**Output Over-Current Protection:**

AEH30M48(N) DC/DC converters feature Over-current Protection (OCP) circuits. When output current exceeds 110% to 130% of rated current, such as during a short circuit condition, the output will shutdown immediately, and can tolerate short circuit conditions indefinitely.

When the over-current condition is removed, the converter will automatically restart.

**Output Over-Voltage Protection**

The over-voltage protection has a separate feedback loop which activates when the output voltage is between 1.8~2.3V. When an over-voltage condition occurs, a "turn off" signal is sent to the input of the module which will shut down the output. The module will restart after power on again.

If the module is trimmed up to the voltage,

which exceeds the 110% rated output voltage, the output over-voltage protection will be probably triggered off.

**Output Filters**

When the load is sensitive to ripple and noise, an output filter can be added to minimize the effects. A simple output filter to reduce output ripple and noise can be made by connecting a capacitor across the output as shown in Figure 12. The recommended value for the output capacitor C1 is 2200μF/16V(low ESR).

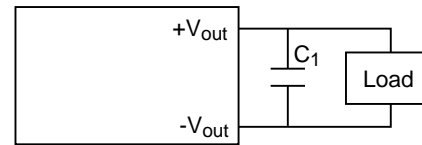

**Fig.12 Output Ripple Filter**

Extra care should be taken when long leads or traces are used to provide power to the load. Long lead lengths increase the chance for noise to appear on the lines. Under these conditions C2 can be added across the load as shown in Figure 13. The recommended component for C2 is 2200μF/16V(low ESR) capacitor and connecting a 0.1μF ceramic capacitor C1 in parallel generally.

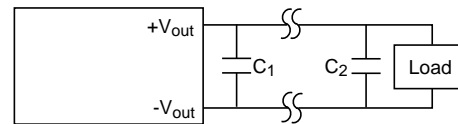

**Fig.13 Output Ripple Filter For a Distant Load**

**Decoupling**

Noise on the power distribution system is not always created by the converter. High speed analog or digital loads with dynamic power demands can cause noise to cross the power inductor back onto the input lines. Noise can be reduced by decoupling the load. In most cases, connecting a 10  $\mu$ F tantalum capacitor in parallel with a 0.1 $\mu$ F ceramic capacitor across the load will decouple it. The capacitors should be connected as close to the load as possible.

**Ground Loops**

Ground loops occur when different circuits are given multiple paths to common or earth ground, as shown in Figure 14. Multiple ground points can slightly different potential and cause current flow through the circuit from one point to another. This can result in additional noise in all the circuits. To eliminate the problem, circuits should be designed with a single ground connection as shown in Figure 15.

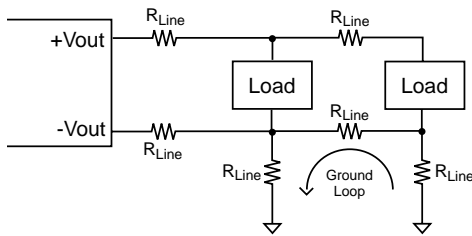

**Fig.14 Ground Loops**

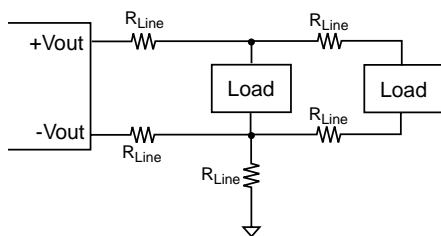

**Fig.15 Single Point Ground**

**Parallel Power Distribution**

Figure 16 shows a typical parallel power distribution design. Such designs, sometimes called daisy chains, can be used for very low output currents, but are not normally recommended. The voltage across loads far from the source can vary greatly depending on the IR drops along the leads and changes in the loads closer to the source. Dynamic load conditions increase the potential problems.

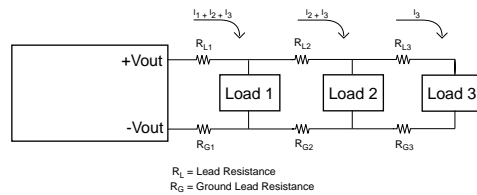

**Fig.16 Parallel Power Distribution**

**Radial Power Distribution**

Radial power distribution is the preferred method of providing power to the load. Figure 17 shows how individual loads are connected directly to the power source. This arrangement requires additional power leads, but it avoids the voltage variation problems associated with the parallel power distribution technique.

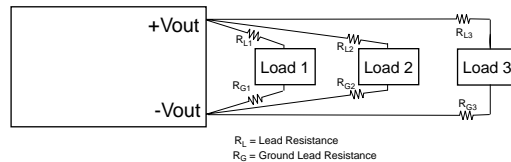

**Fig.17 Radial Power Distribution**

**Mixed Distribution**

In the real world a combination of parallel and radial power distribution is often used. Dynamic and high current loads are connected using a radial design, while static and low current loads can be connected in parallel. This combined approach minimizes the drawbacks of a parallel design when a purely radial design is not feasible.

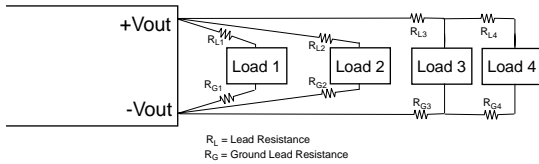

**Fig.18 Mixed Power Distribution**

**Redundant Operation**

A common requirement in high reliability systems is to provide redundant power supplies. The easiest way to do this is to place two converters in parallel, providing fault tolerance but not load sharing. Oring diodes should be used to ensure that failure of one converter will not cause failure of the second. Figure 19 shows such an arrangement. Upon application of power, one of the converters will provide a slightly higher output voltage and will support the full load demand. The second converter will see a zero load condition and will “idle”. If the first converter should fail, the second converter will support the full load. When designing redundant converter circuits, Schottky diodes should be used to minimize the forward voltage drop. The voltage drop across the Schottky diodes must also be considered when determining load voltage requirements.

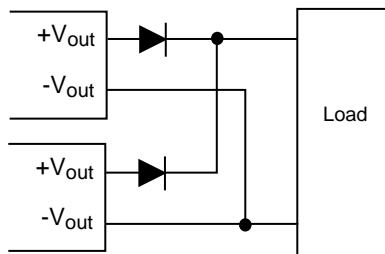

**Fig.19 Redundant Operation**

## Thermal Management

**Technologies**

AEH30M48(N) modules feature high efficiency, it have typical efficiency of 78% at full load. With less heat dissipation and temperature-resistant components such as ceramic capacitors, these modules exhibit good behavior during prolonged exposure to high temperatures. Maintaining the operating board temperature ( $T_c$ ) within the specified range help keep internal-component temperatures within their specifications which in turn help keep MTBF from falling below the specified rating. Proper cooling of the power modules is also necessary for reliable and consistent operation.

**Basic Thermal Management**

Measuring the case temperature of the module ( $T_c$ ) as the method shown in Figure 20 can verify the proper cooling. Figure 20 shows the metal surface of the module and the pin locations. The module should work under 100°C for the reliability of operation and  $T_c$  must not exceed 100°C while operating in the final system configuration. The measurement can be made with a surface probe after the module has

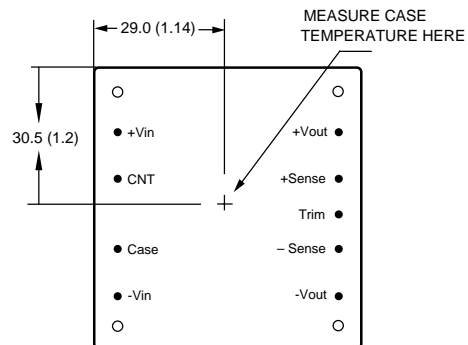

Base-plate side View  
 Dimensions: millimeters (inches)

**Fig.20 Case Temperature Measurement**



## AEH High Efficiency Series Half-Brick Power Converters 36VDC to 75VDC Input, 1.5V@30A Output

reached thermal equilibrium. If a heat sink is mounted to the case, make the measurement as close as possible to the indicated position. It makes the assumption that the final system configuration exists and can be used for a test environment.

The following text and graphs show guidelines to predict the thermal performance of the module for typical configurations that include heat sinks in natural or forced airflow environments. Note that  $T_c$  of module must always be checked in the final system configuration to verify proper operational due to the variation in test conditions.

Thermal management acts to transfer the heat dissipated by the module to the surrounding environment. The amount of power dissipated by the module as heat ( $P_D$ ) is got by the equation below:

$$P_D = P_i - P_o$$

where :  $P_i$  is input power;

$P_o$  is output power;

$P_D$  is dissipated power.

Also, module efficiency ( $\eta$ ) is defined as the following equation:

$$\eta = P_o / P_i$$

From two above equations can yield the equation below:

$$P_D = P_o (1 - \eta) / \eta$$

The module power dissipation then can be calculated through the equation.

Because each power module output voltage has a different power dissipation curve, a plot of power dissipation versus output current over three different line voltages is given in each module-specific data sheet. The typical power dissipation curve of AEH30M48(N) is shown in figure21.

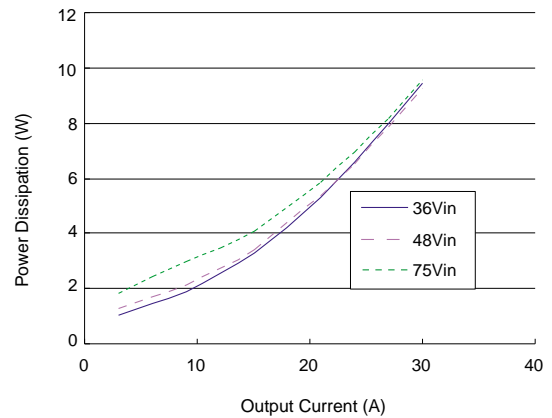
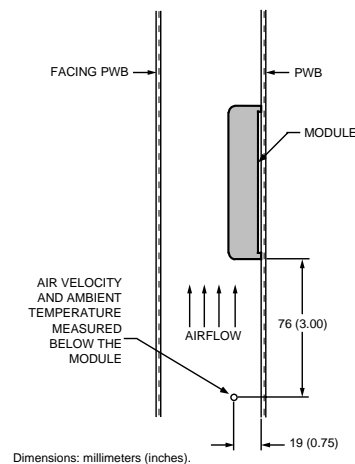

**Fig.21 AEH30M48N Power Dissipation Curves**

## Module Derating

### Experiment Setup

From the experimental set up shown in figure 22, the derating curves as figure 23 can be drawn. Note that the PWB ( printed-wiring board ) and the module must be mounted vertically. The passage has a rectangular cross-section. The clearance between the facing PWB and the top of the module is kept 13 mm (0.5 in.) constantly.



**Fig.22 Experiment Set Up**

# AEH High Efficiency Series Half-Brick Power Converters

## 36VDC to 75VDC Input, 1.5V@30A Output

### Convection Without Heat Sinks

Heat transfer can be enhanced by increasing the airflow over the module. Figure 23 shows the maximum power that can be dissipated by the module.

In the test, natural convection airflow was measured at 0.05 m/s to 0.1 m/s (10 ft./min. to 20 ft./min.). The 0.5 m/s to 4.0 m/s (100 ft./min. to 800 ft./min.) curves are tested with externally adjustable fans. The appropriate airflow for a given operating condition can be determined through figure 23.

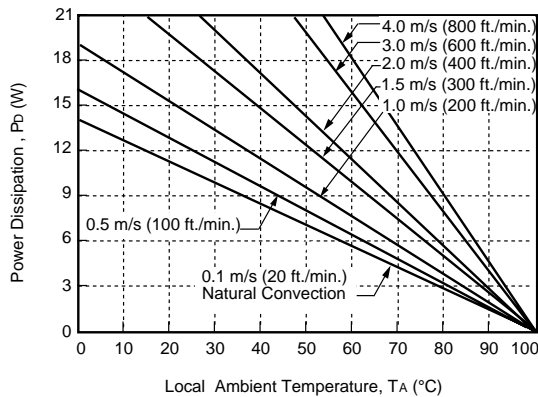

**Fig.23 Forced Convection Power Derating without Heat Sink**

### Heat Sink Configuration

Several standard heat sinks available for the AEH30M48(N) is shown in Figure 24 to Figure 36.

The heat sinks mount to the top surface of the module with screws torqued to 0.56 N-m (5 in.-lb). A thermally conductive dry pad or thermal grease is placed between the case and the heat sink to minimize contact resistance (typically 0.1°C/W to 0.3°C/W) and temperature differential.

Nomenclature for heat sink configurations is as follows:

WDxyyy40

where:

x = fin orientation: longitudinal (L) or transverse (T)

yyy = heat sink height (in 100ths of inch)

For example, WDT5040 is a heat sink that is transverse mounted (see Figure 31) for a 61 mm x 57.9 mm (2.4 in.x 2.28 in.) module with a heat sink height of 0.5 in.

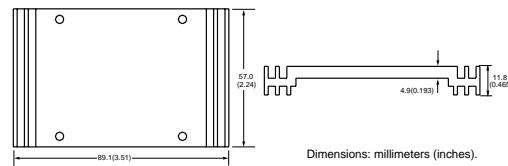

**Fig.24 Non Standard Heatsink**

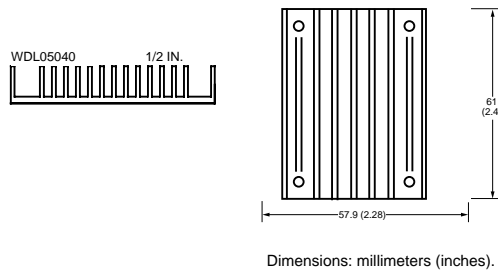

**Fig.25 Longitudinal Fins Heat Sink**

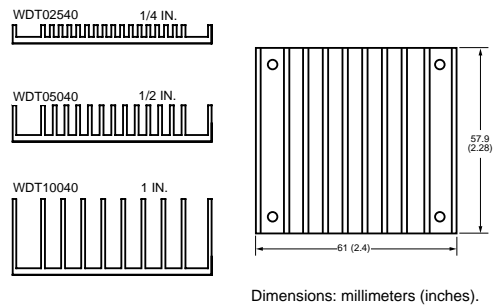

**Fig.26 Transverse Fins Heat Sink**

### Heatsink Mounting Advice

A crucial part of the thermal design strategy is the thermal interface between the baseplate of the module and the heatsink. Inadequate mea-

**AEH High Efficiency Series Half-Brick Power Converters**  
**36VDC to 75VDC Input, 1.5V@30A Output**

asures taken here will quickly negate any other attempts to control the baseplate temperature. For example, using a conventional dry insulator can result in a case-heat-sink thermal impedance of  $>0.5^{\circ}\text{C}/\text{W}$ , while use one of the recommended interface methods (silicon grease or thermal pads available from Emerson Network Power) can result in a case-heat-sink thermal impedance around  $0.1^{\circ}\text{C}/\text{W}$ .

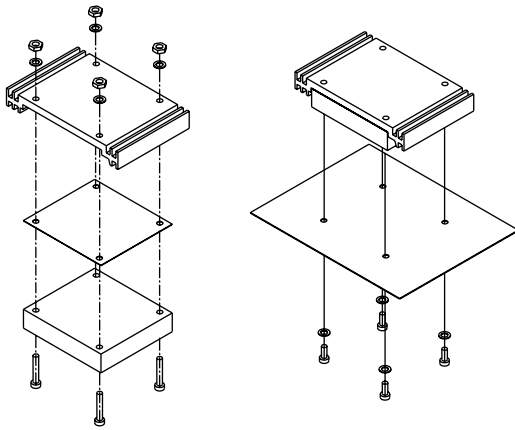

**Fig.27 Heat Sink Mounting**

**Natural Convection with Heat Sink**

The power derating for a module with the heat sinks ( shown as figure 21) in natural convection is shown in figure 28. In this test, natural convection generates airflow about 0.05 m/s to

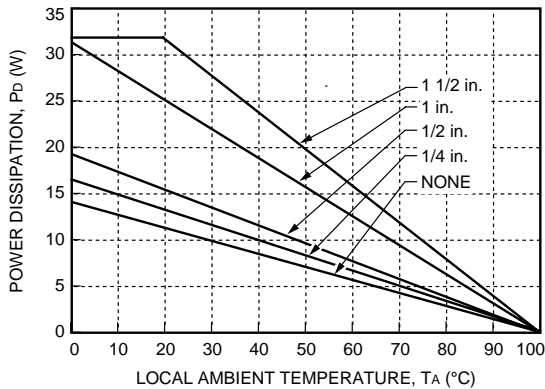

**Fig.28 Heat Sink Power Derating Curves, Natural Convection**

0.1 m/s ( 10ft./min to 20ft./min ).

Figure 28 can be used for heat-sink selection in natural convection environment.

**Basic Thermal Model**

There is another approach to analyze module thermal performance, to model the overall thermal resistance of the module. This presentation method is especially useful when considering heat sinks. The following equation can be used to calculate the total thermal resistance .

$$RCA = \Delta T_{C, \max} / P_D$$

**Where** RCA is the module thermal resistance;

$\Delta T_{C, \max}$  is the maximum case temperature rise;

$P_D$  is the module power dissipation.

In this model,  $P_D$ ,  $\Delta T_{C, \max}$ , and RCA are equals to current flow, voltage drop, and electrical resistance, respectively, in Ohm's law, as shown in Figure 29. Also,  $\Delta T_{C, \max}$  is defined as the difference between the module case temperature ( $T_C$ ) and the inlet ambient temperature ( $T_A$ ).

$$\Delta T_{C, \max} = T_C - T_A$$

**Where**  $T_C$  is the module case temperature,

$T_A$  is the inlet ambient temperature.

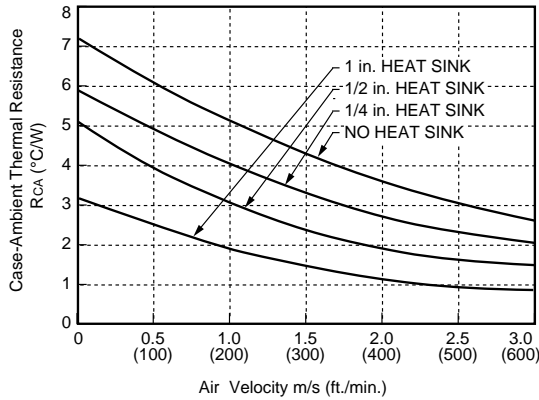

**Fig.29 Basic Thermal Resistance Model**

For AEH30M48(N), the module's thermal resistance values versus air velocity have been determined experimentally and shown in figure 30. The highest values on each curve represents the point of natural convection.

**AEH High Efficiency Series Half-Brick Power Converters  
36VDC to 75VDC Input, 1.5V@30A Output**

Figure 30 is used for determining thermal performance under various conditions of airflow and heat sink configurations.



**Fig.30 Case-to-Ambient Thermal Resistance Curves; Either Orientation**

the converter. Cleaning can be performed with cleaning solvent IPA or with water.

## MTBF

The MTBF, calculated in accordance with Bellcore TR-NWT-000332 is 2,000,000 hours. Obtaining this MTBF in practice is entirely possible. If the ambient air temperature is expected to exceed +25°C, then we also advise a heatsink on the AEH30M48(N), oriented for the best possible cooling in the air stream.

Emerson Network Power can supply replacements for converters from other manufacturers, or offer custom solutions. Please contact the factory for details.

## Mechanical Considerations

### Installation

Although AEH30M48(N) converters can be mounted in any orientation, free air-flowing must be taken. Normally power components are always put at the end of the airflow path or have the separate airflow paths. This can keep other system equipment cooler and increase component life spans.

### Soldering

AEH30M48(N) is compatible with standard wave soldering techniques. When wave soldering, the converter pins should be preheated for 20-30 seconds at 110°C, and wave soldered at 260°C for less than 10 seconds.

When hand soldering, the iron temperature should be maintained at 425°C and applied to the converter pins for less than 5 seconds. Longer exposure can cause internal damage to

**AEH High Efficiency Series Half-Brick Power Converters**  
**36VDC to 75VDC Input, 1.5V@30A Output**

## Recommend Hole Pattern

Base-plate side view

Dimensions are in millimeters and (inches).

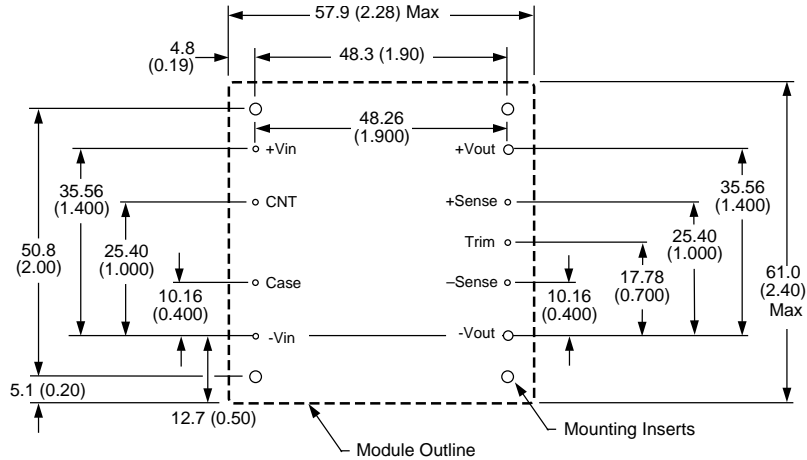

## Mechanical Chart

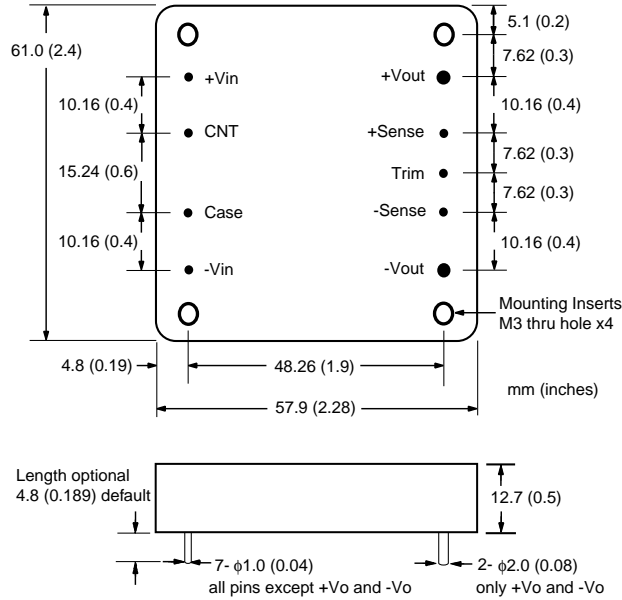

| Pin Length Option                      | Device Code Suffix |
|--|--------------------|
| 4.80mm ± 0.5mm<br>0.189in. ± 0.020in.  | none (default)     |
| 3.80mm ± 0.25mm<br>0.150in. ± 0.010in. | -6                 |
| 5.80mm ± 0.5mm<br>0.228in. ± 0.02in.   | -7                 |
| 2.80mm ± 0.25mm<br>0.110in. ± 0.010in. | -8                 |

Tolerances:  
 Inches                  Millimeters  
 .xx ±0.020              .x ±0.5  
 .xxx ±0.010             .xx ±0.25

Pins  
 >4mm                    ±0.02inch ( ±0.5mm)  
 <4mm                    ±0.01inch ( ±0.25mm)

Base-plate side view