

Silicon PIN Photodiode

Description

BPW97 is an extra high speed PIN photodiode in a hermetically sealed TO-18 package.

Unlike most similar devices, the cathode terminal is isolated from case and connected to a third terminal, giving the user all the means to improve shielding of his system.

Due to its high precision flat glass window and its accurate chip alignment, this device is recommended for ambitious applications in the optical data transmission domain.

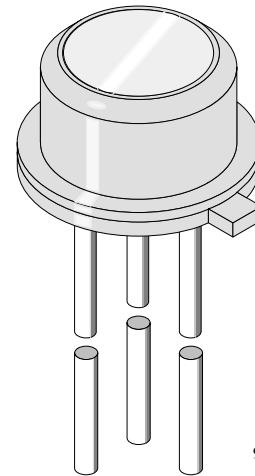

94 8478

Features

- Extra fast response times at low operating voltages
- Exact central chip alignment
- Chip insulated
- Shielded construction
- Hermetically sealed TO-18 case
- Flat optical window
- Wide angle of half sensitivity $\phi = \pm 55^\circ$
- Radiant sensitive area $A=0.25\text{mm}^2$
- Suitable for visible and near infrared radiation
- Suitable for coupling with $50\ \mu\text{m}$ gradient index fiber

Applications

Wide band detector for demodulation of fast signals, e.g. of lasers and GaAs emitters.

Detector for optical communication, e.g. for optical fiber transmission systems with only 5 V power supply.

Absolute Maximum Ratings

$T_{\text{amb}} = 25^\circ\text{C}$

Parameter	Test Conditions	Symbol	Value	Unit
Reverse Voltage		V_R	60	V
Power Dissipation	$T_{\text{amb}} \leq 25^\circ\text{C}$	P_V	285	mW
Junction Temperature		T_j	125	$^\circ\text{C}$
Storage Temperature Range		T_{stg}	-55...+125	$^\circ\text{C}$
Soldering Temperature	$t \leq 5\ \text{s}$	T_{sd}	260	$^\circ\text{C}$
Thermal Resistance Junction/Ambient		R_{thJA}	350	K/W

Basic Characteristics

 $T_{amb} = 25^{\circ}\text{C}$

Parameter	Test Conditions	Symbol	Min	Typ	Max	Unit
Forward Voltage	$I_F = 50\text{ mA}$	V_F		0.9	1.2	V
Breakdown Voltage	$I_R = 100\text{ }\mu\text{A}, E = 0$	$V_{(BR)}$	60			V
Reverse Dark Current	$V_R = 50\text{ V}, E = 0$	I_{ro}		1	5	nA
Diode Capacitance	$V_R = 50\text{ V}, f = 1\text{ MHz}, E = 0$	C_D		1.7		pF
Dark Resistance	$V_R = 10\text{ mV}, E = 0, f = 0$	R_D		5		$\text{G}\Omega$
Serial Resistance	$V_R = 50\text{ V}, f = 1\text{ MHz}$	R_S		180		Ω
Reverse Light Current	$E_e = 1\text{ mW/cm}^2,$ $\lambda = 870\text{ nm}, V_R = 50\text{ V}$	I_{ra}	1.0	1.3		μA
	$E_e = 1\text{ mW/cm}^2,$ $\lambda = 950\text{ nm}, V_R = 50\text{ V}$	I_{ra}		0.9		μA
Temp. Coefficient of I_{ra}	$V_R = 50\text{ V}, \lambda = 870\text{ nm}$	$TK_{I_{ra}}$		0.2		%/K
Absolute Spectral Sensitivity	$V_R = 5\text{ V}, \lambda = 870\text{ nm}$	$s(\lambda)$		0.50		A/W
	$V_R = 5\text{ V}, \lambda = 950\text{ nm}$	$s(\lambda)$		0.35		A/W
Angle of Half Sensitivity		ϕ		± 55		deg
Wavelength of Peak Sensitivity		λ_p		810		nm
Range of Spectral Bandwidth		$\lambda_{0.5}$		560...960		nm
Quantum Efficiency	$\lambda = 850\text{ nm}$	η		80		%
Noise Equivalent Power	$V_R = 50\text{ V}, \lambda = 870\text{ nm}$	NEP		3.6×10^{-14}		$\text{W}/\sqrt{\text{Hz}}$
Detectivity	$V_R = 50\text{ V}, \lambda = 870\text{ nm}$	D^*		1.4×10^{12}		$\text{cm}\sqrt{\text{Hz}}/\text{W}$
Rise Time	$V_R = 3.8\text{ V}, R_L = 50\text{ }\Omega,$ $\lambda = 780\text{ nm}$	t_r		1.2		ns
Fall Time	$V_R = 3.8\text{ V}, R_L = 50\text{ }\Omega,$ $\lambda = 780\text{ nm}$	t_f		1.2		ns
Rise Time	$V_R = 50\text{ V}, R_L = 50\text{ }\Omega,$ $\lambda = 820\text{ nm}$	t_r		0.6		ns
Fall Time	$V_R = 50\text{ V}, R_L = 50\text{ }\Omega,$ $\lambda = 820\text{ nm}$	t_f		0.6		ns
Cut-Off Frequency	$\lambda = 820\text{ nm}$	f_c		1		GHz

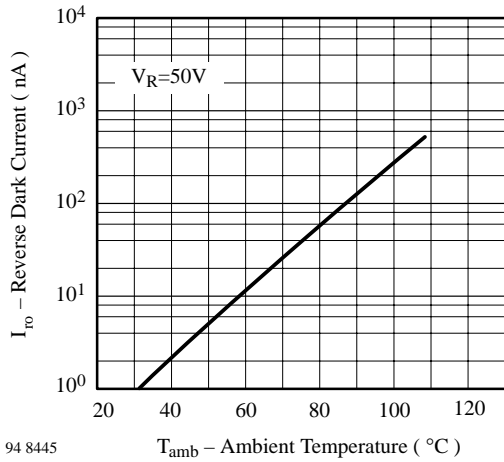
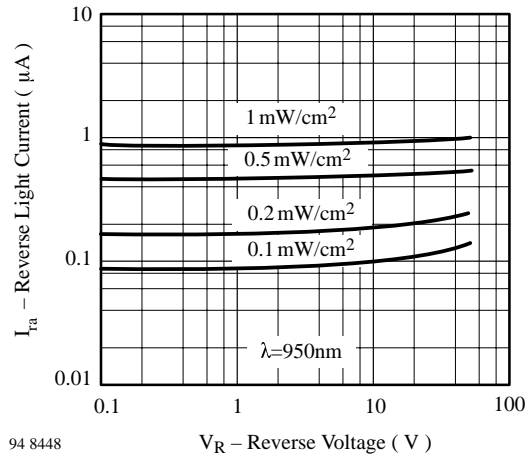
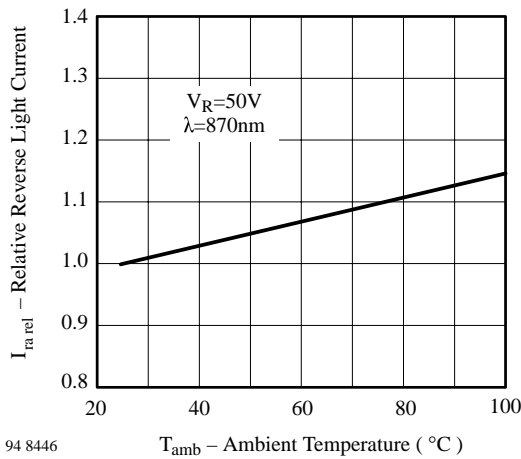
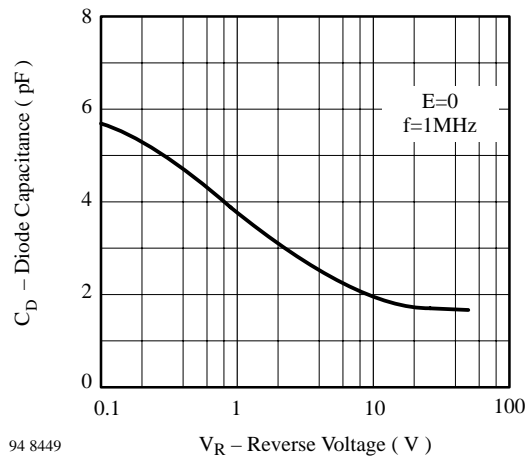
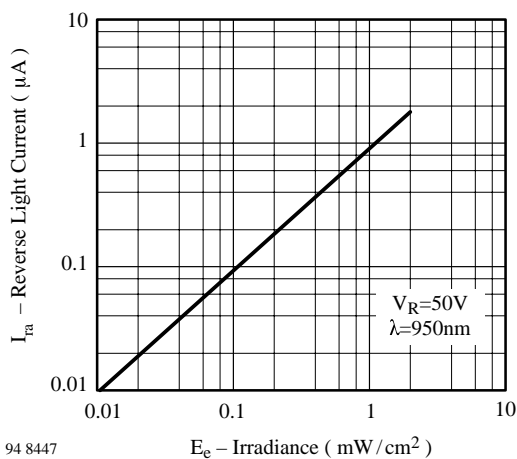
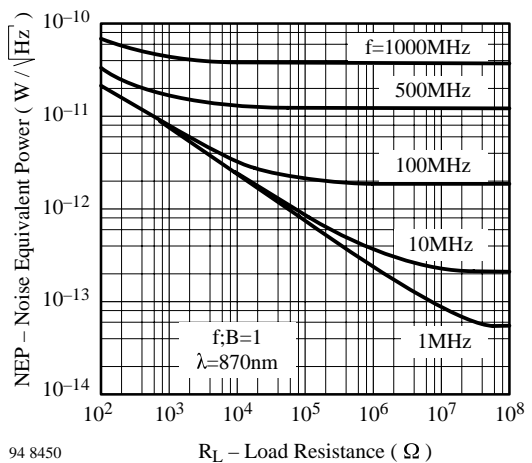
Typical Characteristics ($T_{amb} = 25^{\circ}\text{C}$ unless otherwise specified)

Figure 1. Reverse Dark Current vs. Ambient Temperature

Figure 4. Reverse Light Current vs. Reverse Voltage

Figure 2. Relative Reverse Light Current vs. Ambient Temperature

Figure 5. Diode Capacitance vs. Reverse Voltage

Figure 3. Reverse Light Current vs. Irradiance

Figure 6. Noise Equivalent Power vs. Load Resistance

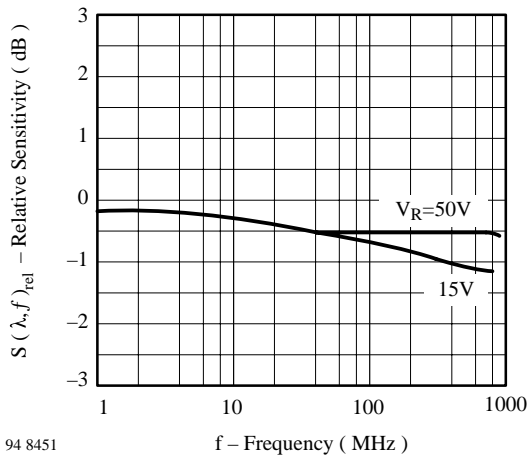

Figure 7. Relative Sensitivity vs. Frequency

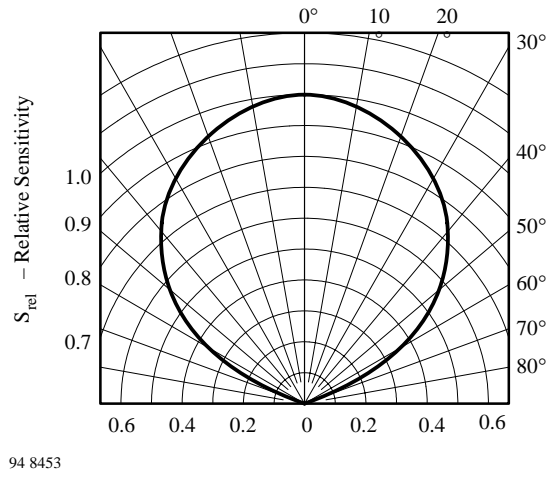

Figure 9. Relative Radiant Sensitivity vs. Angular Displacement

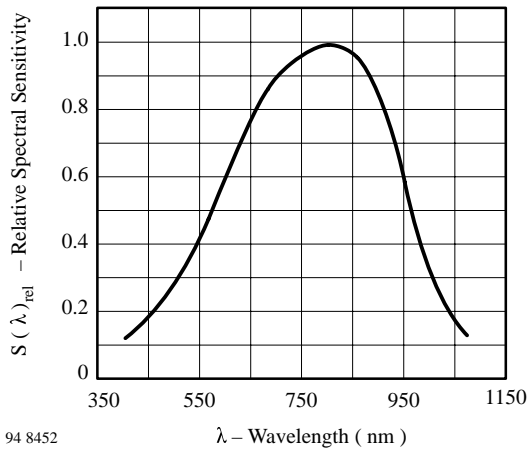
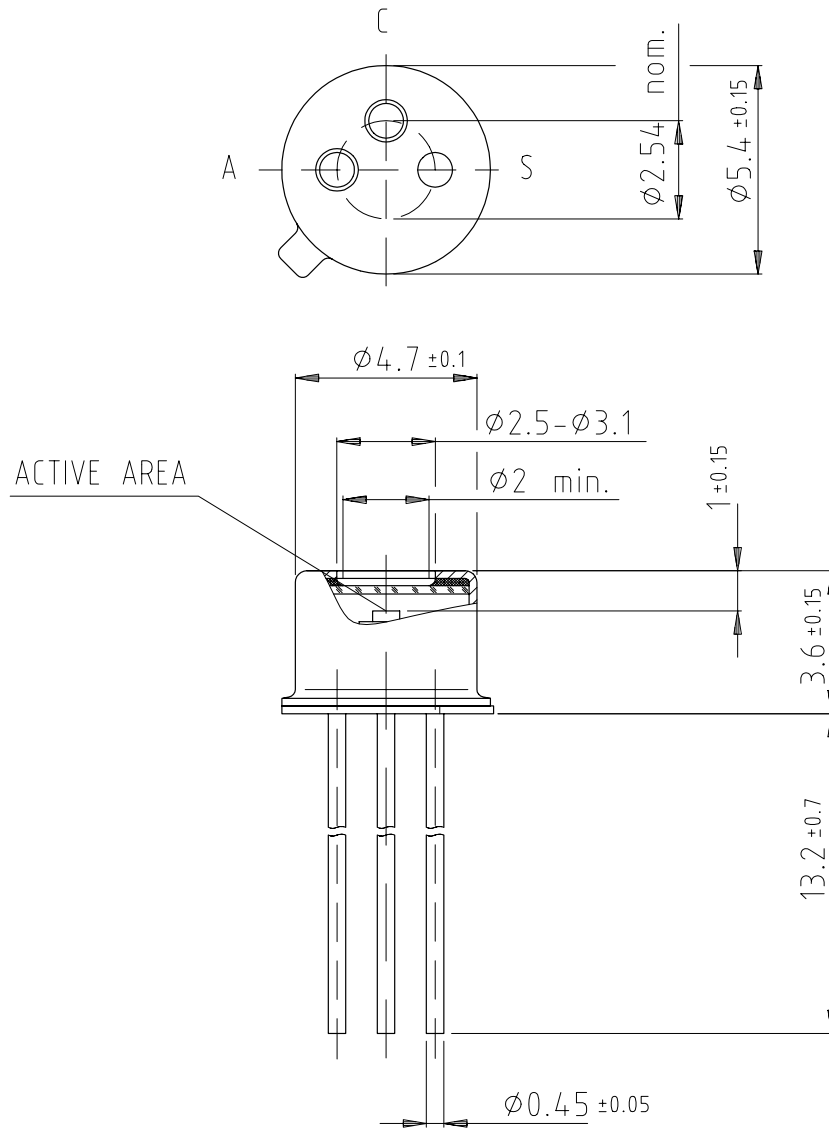
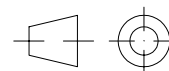

Figure 8. Relative Spectral Sensitivity vs. Wavelength

Dimensions in mm



96 12182



technical drawings
according to DIN
specifications

Ozone Depleting Substances Policy Statement

It is the policy of **Vishay Semiconductor GmbH** to

1. Meet all present and future national and international statutory requirements.
2. Regularly and continuously improve the performance of our products, processes, distribution and operating systems with respect to their impact on the health and safety of our employees and the public, as well as their impact on the environment.

It is particular concern to control or eliminate releases of those substances into the atmosphere which are known as ozone depleting substances (ODSs).

The Montreal Protocol (1987) and its London Amendments (1990) intend to severely restrict the use of ODSs and forbid their use within the next ten years. Various national and international initiatives are pressing for an earlier ban on these substances.

Vishay Semiconductor GmbH has been able to use its policy of continuous improvements to eliminate the use of ODSs listed in the following documents.

1. Annex A, B and list of transitional substances of the Montreal Protocol and the London Amendments respectively
2. Class I and II ozone depleting substances in the Clean Air Act Amendments of 1990 by the Environmental Protection Agency (EPA) in the USA
3. Council Decision 88/540/EEC and 91/690/EEC Annex A, B and C (transitional substances) respectively.

Vishay Semiconductor GmbH can certify that our semiconductors are not manufactured with ozone depleting substances and do not contain such substances.

We reserve the right to make changes to improve technical design and may do so without further notice.

Parameters can vary in different applications. All operating parameters must be validated for each customer application by the customer. Should the buyer use Vishay-Semiconductors products for any unintended or unauthorized application, the buyer shall indemnify Vishay-Semiconductors against all claims, costs, damages, and expenses, arising out of, directly or indirectly, any claim of personal damage, injury or death associated with such unintended or unauthorized use.

Vishay Semiconductor GmbH, P.O.B. 3535, D-74025 Heilbronn, Germany
Telephone: 49 (0)7131 67 2831, Fax number: 49 (0)7131 67 2423