

# SMD Power Inductor CDRH169RB



Halogen Free



## Description

- Ferrite drum core construction.
- Magnetically shielded.
- L × W × H: 16.5 × 16.5 × 10.0mm Max.
- Product weight: 8.2g(Ref.)
- Moisture Sensitivity Level: 1
- RoHS compliance.
- Halogen Free available.

## Environmental Data

- Operating temperature range: -40°C ~ +105°C (including coil's self temperature rise)
- Storage temperature range: -40°C ~ +105°C
- Solder reflow temperature: 260 °C peak.

## Packaging

- Carrier tape and reel packaging.
- 13.0" diameter reel
- 200pcs per reel

## Applications

- Ideally used in Game machine, Notebook PC, LCD TV, DVD, STB, Projector etc as DC-DC converter inductors.

## Dimension - [mm]

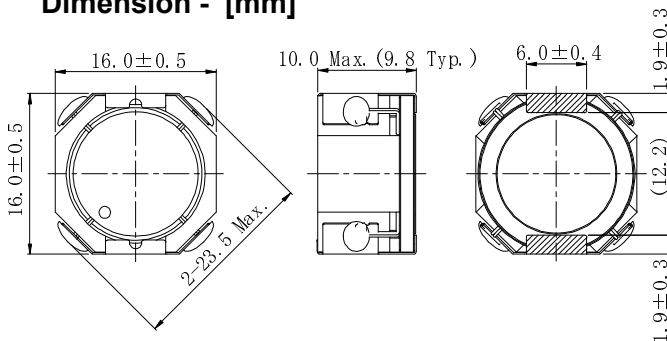

## Land pattern and Schematics - [mm]

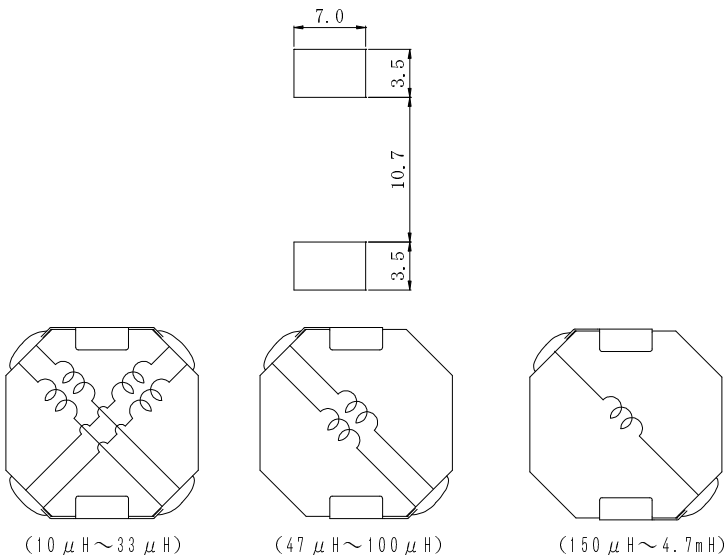

# SMD Power Inductor CDRH169RB



## Electrical Characteristics

Part No.	Stamp	Inductance [Within] ※1	D.C.R.( $\Omega$ ) [Max.] (Typ.) (at 20°C)	Saturation current (A) ※2		Temperature rise current (A) ※3
				(at 20°C)	(at 105°C)	
CDRH169RBNP-100MC	100	10 $\mu$ H $\pm$ 20%	9.3m(7.4m)	11.0	8.5	9.2
CDRH169RBNP-150MC	150	15 $\mu$ H $\pm$ 20%	12.5m(10.0m)	9.0	7.0	7.5
CDRH169RBNP-220MC	220	22 $\mu$ H $\pm$ 20%	19.0m(15.0m)	7.5	6.0	6.3
CDRH169RBNP-330MC	330	33 $\mu$ H $\pm$ 20%	28.0m(22.0m)	6.0	4.6	5.0
CDRH169RBNP-470MC	470	47 $\mu$ H $\pm$ 20%	36.0m(29.0m)	5.0	3.8	4.3
CDRH169RBNP-680MC	680	68 $\mu$ H $\pm$ 20%	51.0m(41.0m)	4.2	3.3	3.4
CDRH169RBNP-101MC	101	100 $\mu$ H $\pm$ 20%	79.0m(63.0m)	3.4	2.7	2.9
CDRH169RBNP-151MC	151	150 $\mu$ H $\pm$ 20%	121m(97m)	2.8	2.2	2.2
CDRH169RBNP-221MC	221	220 $\mu$ H $\pm$ 20%	0.15(0.12)	2.3	1.8	1.9
CDRH169RBNP-331MC	331	330 $\mu$ H $\pm$ 20%	0.27(0.22)	1.8	1.4	1.4
CDRH169RBNP-471MC	471	470 $\mu$ H $\pm$ 20%	0.37(0.30)	1.6	1.2	1.2
CDRH169RBNP-561MC	561	560 $\mu$ H $\pm$ 20%	0.46(0.37)	1.5	1.1	1.05
CDRH169RBNP-681MC	681	680 $\mu$ H $\pm$ 20%	0.52(0.41)	1.3	1.0	1.0
CDRH169RBNP-102MC	102	1.0mH $\pm$ 20%	0.76(0.61)	1.05	0.8	0.85
CDRH169RBNP-122MC	122	1.2mH $\pm$ 20%	0.83(0.66)	0.95	0.75	0.83
CDRH169RBNP-152MC	152	1.5mH $\pm$ 20%	1.05(0.84)	0.85	0.65	0.72
CDRH169RBNP-222MC	222	2.2mH $\pm$ 20%	1.50(1.20)	0.70	0.55	0.60
CDRH169RBNP-332MC	332	3.3mH $\pm$ 20%	2.13(1.71)	0.60	0.45	0.49
CDRH169RBNP-472MC	472	4.7mH $\pm$ 20%	3.19(2.55)	0.50	0.40	0.40

※1. Inductance measuring condition: at 100kHz.

※2. Saturation current: The value of D.C. current when the inductance decreases to 65% of its nominal value.

※3. Temperature rise current: The value of D.C. current when the temperature rise is  $\Delta t=40^{\circ}\text{C}$  ( $T_a=20^{\circ}\text{C}$ ).

# SMD Power Inductor CDRH169RB



## Saturation Current & Temperature Rise Graph

— L (20°C) — L (105°C) —  $\Delta T$

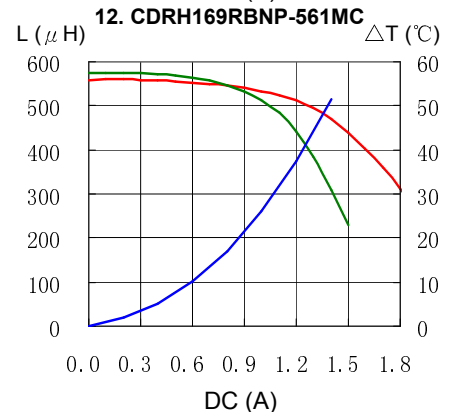
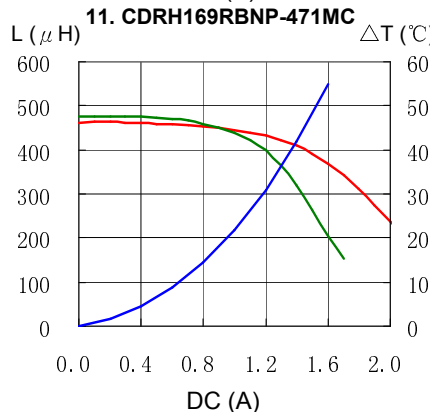
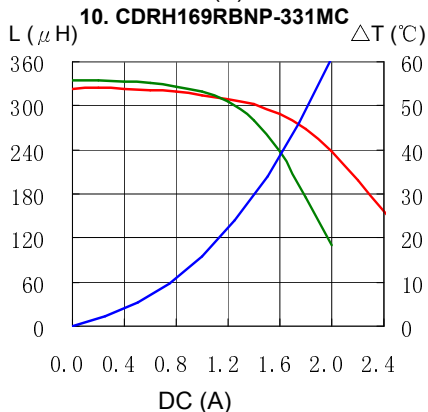
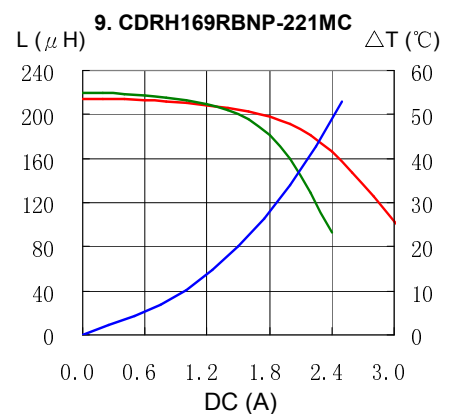
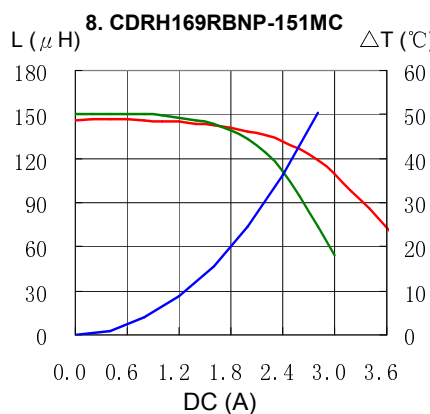
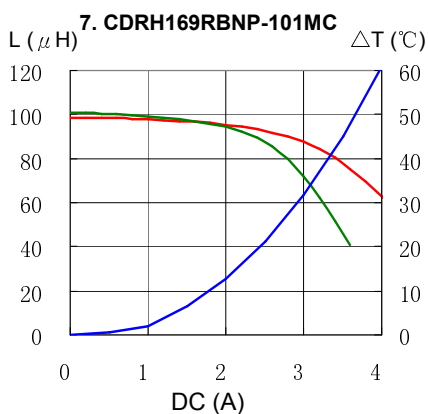
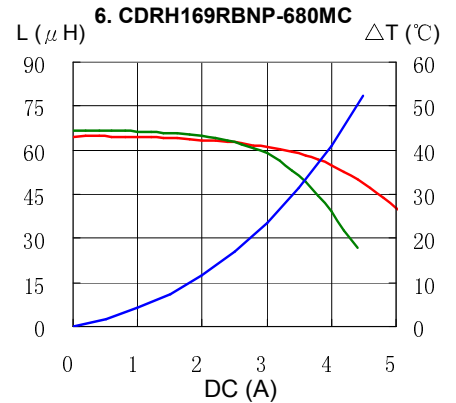
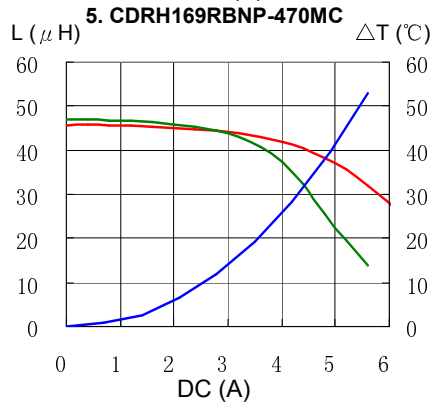
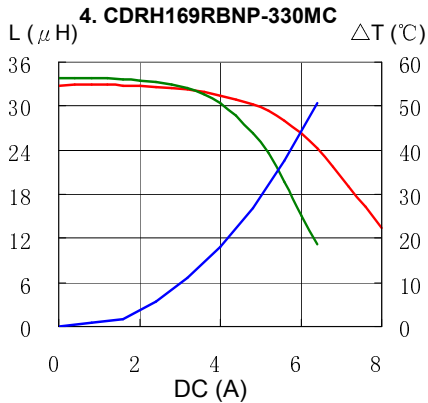
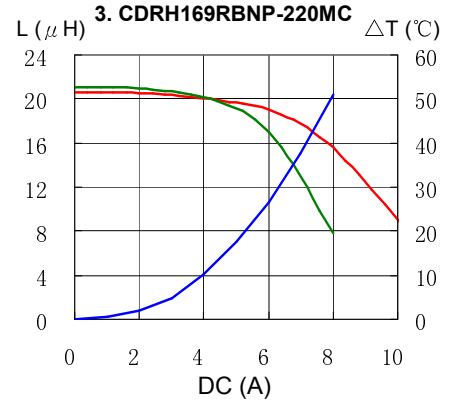
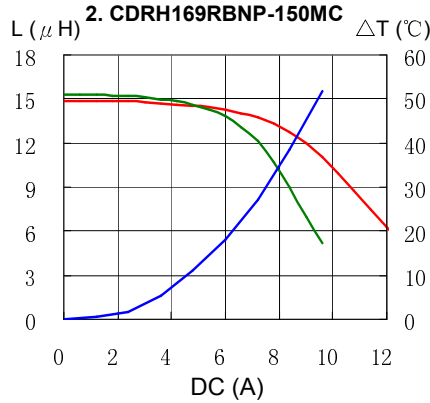
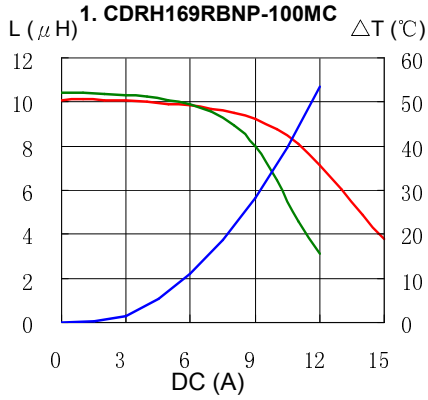

# SMD Power Inductor CDRH169RB



## Saturation Current & Temperature Rise Graph

— L (20°C) — L (105°C) —  $\Delta T$

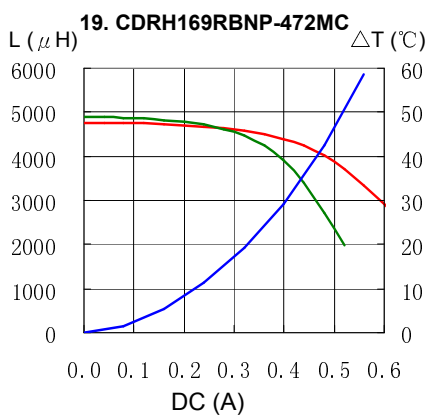
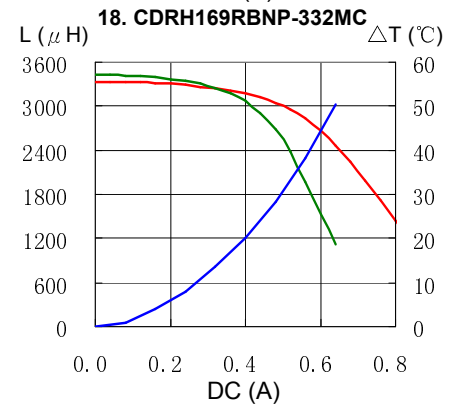
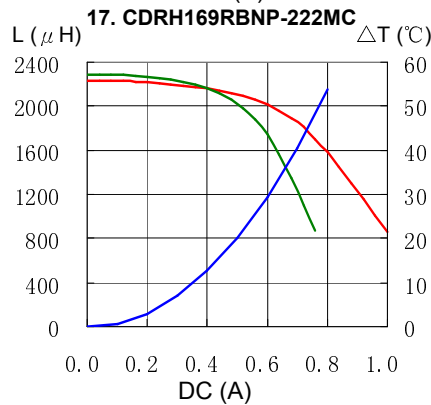
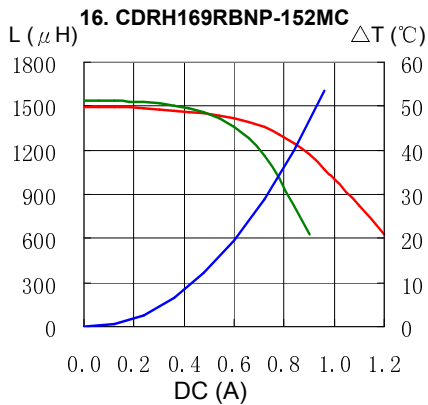
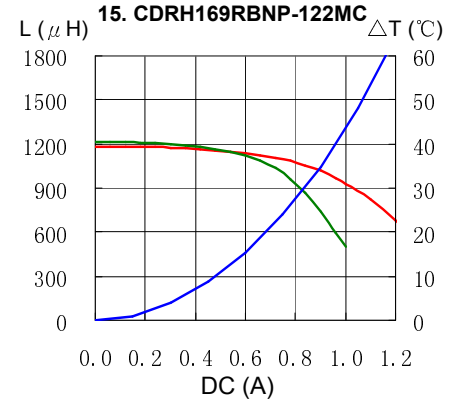
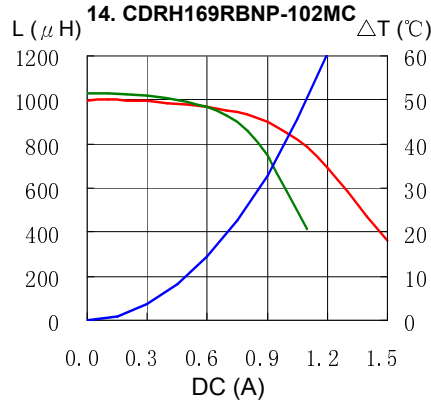
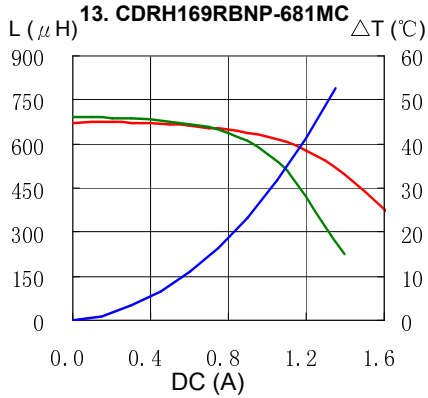

# SMD Power Inductor CDRH169RB



## Solder Reflow Condition



Please refer to the sales offices on our website - <http://www.sumida.com>

### Hong Kong

Tel.+852-2880-6688  
FAX.+852-2565-9600  
[sales@hk.sumida.com](mailto:sales@hk.sumida.com)

### Tokyo

Tel.+81-3-5202-7112  
FAX.+81-3-5202-7105  
[sales@jp.sumida.com](mailto:sales@jp.sumida.com)

### Chicago

Tel.+1-847-545-6700  
FAX. +1-847-545-6720  
[sales@us.sumida.com](mailto:sales@us.sumida.com)

### Shanghai

Tel.+86-021-5836-3299  
FAX.+86-021-5836-3266  
[shanghai.sales@cn.sumida.com](mailto:shanghai.sales@cn.sumida.com)

### Seoul

Tel.+82-2-6237-0777  
FAX.+82-2-6237-0778  
[sales@kr.sumida.com](mailto:sales@kr.sumida.com)

### Oberzell

Tel.+49-8591-937-0  
FAX. +49-8591-937-103  
[contact@sumida-eu.com](mailto:contact@sumida-eu.com)

### Shenzhen

Tel.+86-755-8291-0228  
FAX.+86-755-8291-0338  
[shenzhen.sales@cn.sumida.com](mailto:shenzhen.sales@cn.sumida.com)

### Singapore

Tel.+65-6296-3388  
FAX.+65-6296-3390  
[sales@sg.sumida.com](mailto:sales@sg.sumida.com)

### Neumarkt

Tel.+49-9181-4509-110  
FAX. +49-9181-4509-310  
[infocomp@eu.sumida.com](mailto:infocomp@eu.sumida.com)

### Taipei

Tel.+886-2-8751-2737  
FAX.+886-2-8751-2738  
[sales@tw.sumida.com](mailto:sales@tw.sumida.com)

### San Jose

Tel.+1-408-321-9660  
FAX.+1-408-321-9308  
[sales@us.sumida.com](mailto:sales@us.sumida.com)