

# NCP4626

## 300 mA, Low Dropout Voltage Regulator with Reverse Current Protection

The NCP4626 is a CMOS 300 mA low dropout linear regulator with a wide input voltage range of 3.5 V to 16 V, low supply current and high output voltage accuracy. Through an ECO mode selector pin the device can be operated in low power mode to reduce quiescent current or fast mode for better transient response and lower dropout. The NCP4626 is suitable for applications where the V<sub>OUT</sub> pin voltage may be higher than the V<sub>IN</sub> pin voltage as it is protected against reverse current. The device has a maximum input voltage tolerance of 18 V, comes with or without an auto-discharge feature on the output, and is available in a choice of XDFN, SOT89 and SOT23 packages.

### Features

- Operating Input Voltage Range: 3.5 V to 16.0 V
- Output Voltage Range: 2.0 to 15.0 V (available in 0.1 V steps)
- Low Quiescent current (6  $\mu$ A typ.) in Low Power Mode
- Dropout Voltage:
  - 550 mV typ. (I<sub>OUT</sub> = 300 mA, V<sub>OUT</sub> = 5 V, Fast Mode)
  - 700 mV typ. (I<sub>OUT</sub> = 300 mA, V<sub>OUT</sub> = 5 V, Low Power Mode)
- Output Voltage Accuracy:  $\pm 1.5\%$  (Fast Mode)  
 $\pm 2.5\%$  (Low Power Mode)
- High PSRR: 60 dB at 1 kHz
- Current Fold Back Protection
- Thermal Shutdown Protection
- Stable with a C<sub>IN</sub> = 2.2  $\mu$ F and C<sub>OUT</sub> = 4.7  $\mu$ F Ceramic Capacitors
- Available in 1.6x1.6 XDFN6, SOT89-5 and SOT23-5 Package
- These are Pb-Free Devices

### Typical Applications

- Digital Home Appliances
- Audio Visual Equipment
- Battery backup circuits

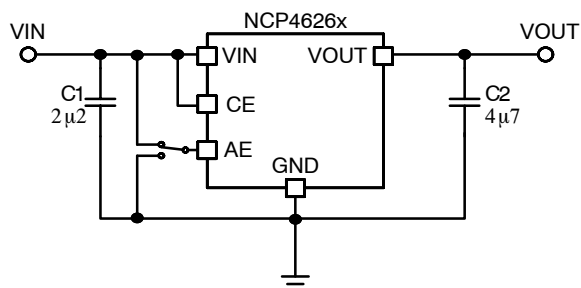

Figure 1. Typical Application Schematic



ON Semiconductor™

<http://onsemi.com>

### MARKING DIAGRAMS

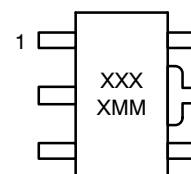

XXX, XXXX = Specific Device Code  
 M, MM = Date Code  
 A = Assembly Location  
 Y = Year  
 W = Work Week  
 ■ = Pb-Free Package

(\*Note: Microdot may be in either location)

### ORDERING INFORMATION

See detailed ordering and shipping information in the package dimensions section on page 25 of this data sheet.

# NCP4626

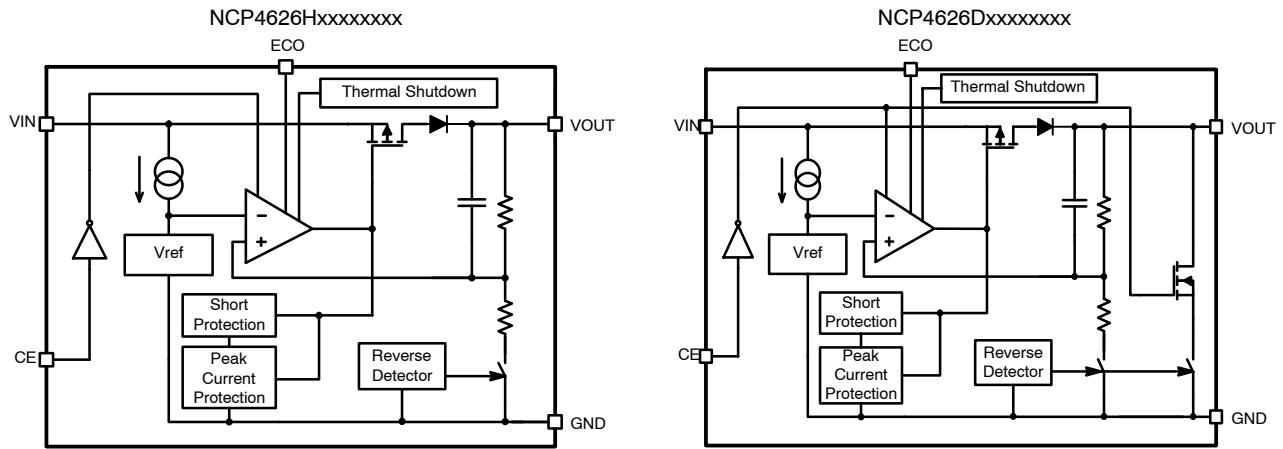

Figure 2. Simplified Schematic Block Diagram

## PIN FUNCTION DESCRIPTION

Pin No. XDFN (Note 1)	Pin No. SOT89	Pin No. SOT23	Pin Name	Description
1	4	1	ECO	Mode selector pin. H – fast mode, L – low power mode
3	5	5	VIN	Input voltage pin
4	1	4	VOUT	Output voltage pin
5	2	2	GND	Ground pin
1	3	3	CE	Chip enable pin ( "H" enabled)
2	-	-	NC	No connection

1. Tab is connected to GND. Tab should be connected to GND, but leaving it unconnected is also acceptable

# NCP4626

## ABSOLUTE MAXIMUM RATINGS

Rating	Symbol	Value	Unit
Input Voltage (Note 2)	$V_{IN}$	-0.3 to 18.0	V
Output Voltage	$V_{OUT}$	-0.3 to 18.0	V
Chip Enable Input	$V_{CE}$	-0.3 to 18.0	V
Mode Selector Input	$V_{ECO}$	-0.3 to $V_{IN} + 0.3 \leq 18.0$	V
Output Current	$I_{OUT}$	400	mA
Power Dissipation XDFN	$P_D$	640	mW
Power Dissipation SOT89		900	
Power Dissipation SOT23		420	
Maximum Junction Temperature	$T_{J(MAX)}$	150	°C
Operation Temperature Range	$T_A$	-40 to 85	°C
Storage Temperature	$T_{STG}$	-55 to 125	°C
ESD Capability, Human Body Model (Note 3)	$ESD_{HBM}$	2000	V
ESD Capability, Machine Model (Note 3)	$ESD_{MM}$	200	V

Stresses exceeding Maximum Ratings may damage the device. Maximum Ratings are stress ratings only. Functional operation above the Recommended Operating Conditions is not implied. Extended exposure to stresses above the Recommended Operating Conditions may affect device reliability.

2. Refer to ELECTRICAL CHARACTERISTICS and APPLICATION INFORMATION for Safe Operating Area.

3. This device series incorporates ESD protection and is tested by the following methods:

ESD Human Body Model tested per AEC-Q100-002 (EIA/JESD22-A114)

ESD Machine Model tested per AEC-Q100-003 (EIA/JESD22-A115)

Latchup Current Maximum Rating tested per JEDEC standard: JESD78.

## THERMAL CHARACTERISTICS

Rating	Symbol	Value	Unit
Thermal Characteristics, XDFN6 Thermal Resistance, Junction-to-Air	$R_{\theta JA}$	156	°C/W
Thermal Characteristics, SOT23-5 Thermal Resistance, Junction-to-Air	$R_{\theta JA}$	238	°C/W
Thermal Characteristics, SOT89-5 Thermal Resistance, Junction-to-Air	$R_{\theta JA}$	111	°C/W

**ELECTRICAL CHARACTERISTICS**  $-40^{\circ}\text{C} \leq T_A \leq 85^{\circ}\text{C}$ ;  $V_{IN} = V_{CE} = V_{OUT(NOM)} + 3.0\text{ V}$ ;  $I_{OUT} = 1\text{ mA}$ ,  $C_{IN} = 2.2\text{ }\mu\text{F}$ ,  $C_{OUT} = 4.7\text{ }\mu\text{F}$ , unless otherwise noted. Typical values are at  $T_A = +25^{\circ}\text{C}$

Parameter	Test Conditions	Symbol	Min	Typ	Max	Unit
Operating Input Voltage	$2.0\text{ V} \leq V_{OUT} < 3.0\text{ V}$	$V_{IN}$	3.5		14.0	V
	$3.0\text{ V} \leq V_{OUT}$				16.0	
Output Voltage	Fast Mode, $V_{ECO} = V_{IN}$	$V_{OUT}$	x0.985		x1.015	V
					$T_A = +25^{\circ}\text{C}$	
	$T_A = -40\text{ to }85^{\circ}\text{C}$				x0.970	
	Low Power Mode, $V_{ECO} = V_{IN}$				$T_A = +25^{\circ}\text{C}$	
$T_A = -40\text{ to }85^{\circ}\text{C}$		x0.960				
Output Voltage Deviation	Fast mode to Low Power mode and back	$\Delta V_{OUT}$	-1.5	0	1.5	%
Output Voltage Temp. Coefficient	$T_A = -40\text{ to }85^{\circ}\text{C}$			$\pm 80$		ppm/°C
Line Regulation	$V_{IN} = V_{OUT} + 0.5\text{ V to }16\text{ V}$ (If $V_{OUT} < 3.0\text{ V, }3.5\text{ V to }14\text{ V}$ )	$Line_{Reg}$		0.02	0.10	%/V

# NCP4626

**ELECTRICAL CHARACTERISTICS**  $-40^{\circ}\text{C} \leq T_A \leq 85^{\circ}\text{C}$ ;  $V_{IN} = V_{CE} = V_{OUT(NOM)} + 3.0\text{ V}$ ;  $I_{OUT} = 1\text{ mA}$ ,  $C_{IN} = 2.2\ \mu\text{F}$ ,  $C_{OUT} = 4.7\ \mu\text{F}$ , unless otherwise noted. Typical values are at  $T_A = +25^{\circ}\text{C}$

Parameter	Test Conditions	Symbol	Min	Typ	Max	Unit
Load Regulation	$I_{OUT} = 1\text{ mA to }300\text{ mA}$	Fast Mode, $V_{ECO} = V_{IN}$		50	120	mV
		Low Power, $V_{ECO} = \text{GND}$		60	130	
Dropout Voltage	$I_{OUT} = 300\text{ mA}$ , Fast Mode, $V_{ECO} = V_{IN}$	$2.0\text{ V} \leq V_{OUT} < 2.5\text{ V}$	V <sub>DO</sub>	1.20	1.80	V
		$2.5\text{ V} \leq V_{OUT} < 3.3\text{ V}$		1.00	1.50	
		$3.3\text{ V} \leq V_{OUT} < 5.0\text{ V}$		0.75	1.00	
		$5.0\text{ V} \leq V_{OUT} < 12.0\text{ V}$		0.55	0.75	
		$12.0\text{ V} \leq V_{OUT}$		0.40	0.60	
	$I_{OUT} = 300\text{ mA}$ , Low Power Mode, $V_{ECO} = \text{GND}$	$2.0\text{ V} \leq V_{OUT} < 2.5\text{ V}$		2.50	3.00	
		$2.5\text{ V} \leq V_{OUT} < 3.3\text{ V}$		2.00	2.50	
		$3.3\text{ V} \leq V_{OUT} < 5.0\text{ V}$		1.50	1.80	
		$5.0\text{ V} \leq V_{OUT} < 12.0\text{ V}$		0.70	1.00	
		$12.0\text{ V} \leq V_{OUT}$		0.40	0.60	
Output Current		$I_{OUT}$	300			mA
Short Current Limit	$V_{OUT} = 0\text{ V}$	$I_{SC}$		50		mA
Quiescent Current	$V_{ECO} = V_{IN}$ , $I_{OUT} = 0\text{ mA}$	$I_Q$		50	100	$\mu\text{A}$
	$V_{ECO} = \text{GND}$ , $I_{OUT} = 0\text{ mA}$			6	15	
Standby Current	$V_{IN} = 16.0\text{ V}$ (If $V_{OUT} < 3.0\text{ V}$ , $V_{IN} = 14.0\text{ V}$ ), $T_A = 25^{\circ}\text{C}$	$I_{STB}$		0.1	1	$\mu\text{A}$
CE and ECO Pin Threshold Voltage	CE Input Voltage "H"	$V_{CEH}$	1.6		$V_{IN}$	V
	CE Input Voltage "L"	$V_{CEL}$	0		0.6	
Power Supply Rejection Ratio	$V_{IN} = V_{ECO} = V_{OUT} + 1.0\text{ V}$ , $\Delta V_{IN} = 0.2\text{ V}_{PP}$ , $f = 1\text{ kHz}$	$2.0\text{ V} \leq V_{OUT} < 5.0\text{ V}$	PSRR	70		dB
		$5.0\text{ V} \leq V_{OUT}$		60		
Output Noise Voltage	$V_{IN} = 6.0\text{ V}$ , $V_{OUT} = 3.0\text{ V}$ , $I_{OUT} = 30\text{ mA}$ , $f = 10\text{ Hz to }100\text{ kHz}$	$V_N$		90		$\mu\text{V}_{rms}$
Thermal Shutdown Temperature		$T_{SD}$		150		$^{\circ}\text{C}$
Thermal Shutdown Release Temperature		$T_{SDR}$		130		$^{\circ}\text{C}$
Reverse Current	$V_{OUT} > 0.6\text{ V}$ , $0\text{ V} \leq V_{IN} \leq 16\text{ V}$	$I_{REV}$		0	0.1	$\mu\text{A}$
Low Output Nch Tr. On Resistance	D Version only, $V_{IN} = 5\text{ V}$ , $V_{CE} = 0\text{ V}$ , $V_{OUT} = 0.3\text{ V}$	$R_{LOW}$		150		$\Omega$

TYPICAL CHARACTERISTICS

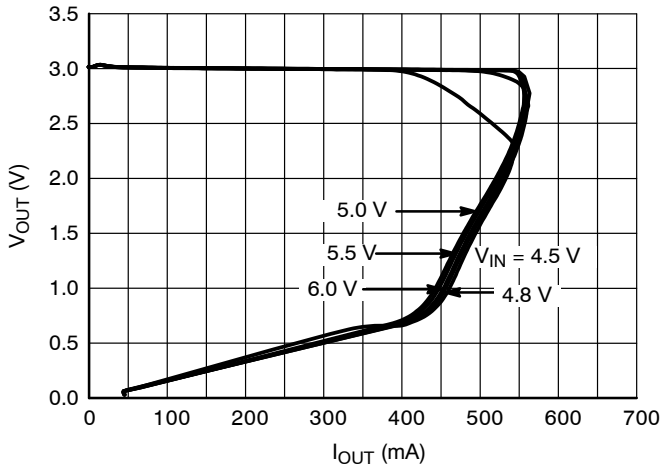

Figure 3. Output Voltage vs. Output Current  
3.0 V, ECO = L

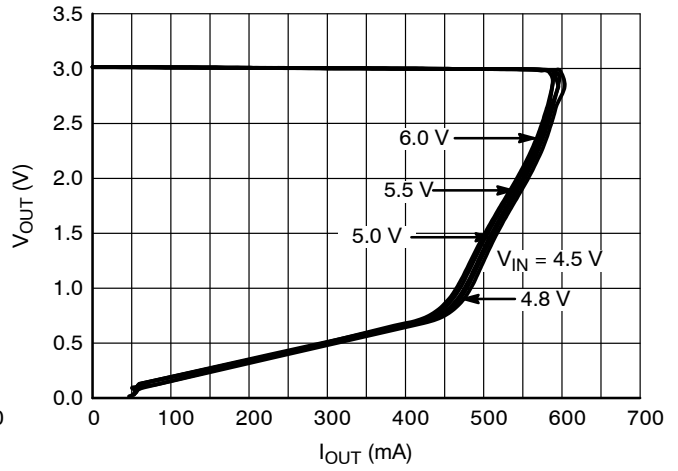

Figure 4. Output Voltage vs. Output Current  
3.0 V, ECO = H

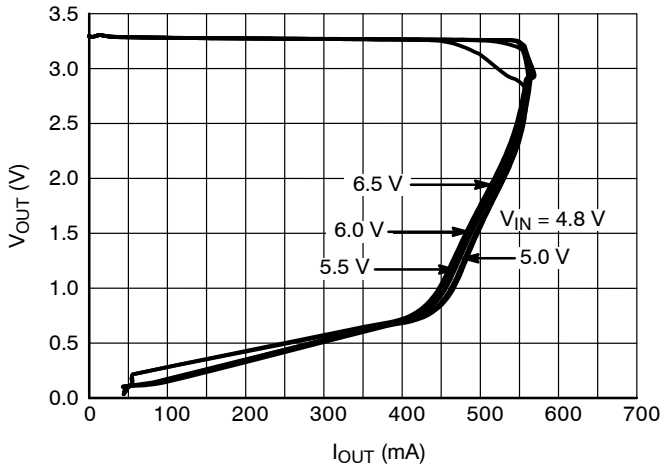

Figure 5. Output Voltage vs. Output Current  
3.3 V, ECO = L

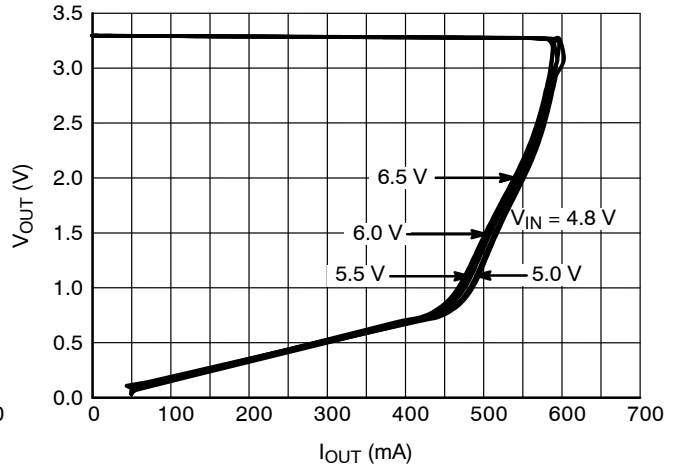

Figure 6. Output Voltage vs. Output Current  
3.3 V, ECO = H

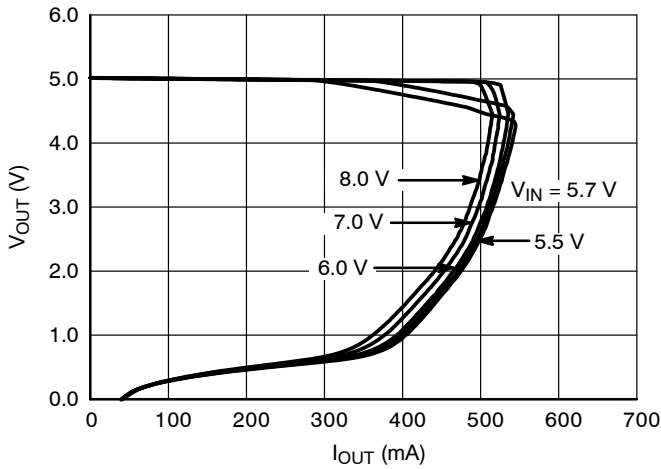

Figure 7. Output Voltage vs. Output Current  
5.0 V, ECO = L

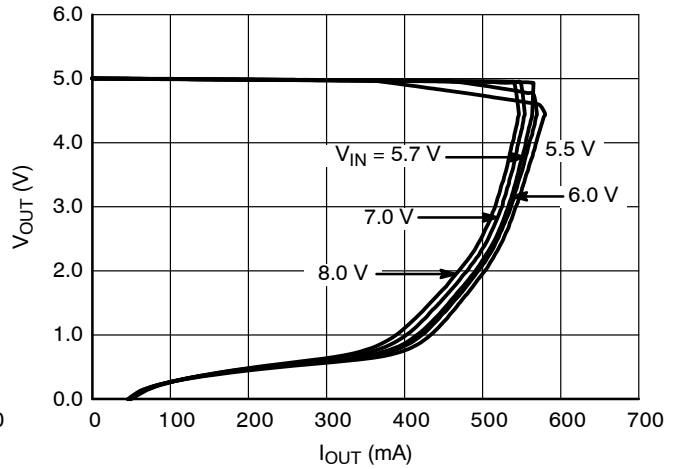

Figure 8. Output Voltage vs. Output Current  
5.0 V, ECO = H

TYPICAL CHARACTERISTICS

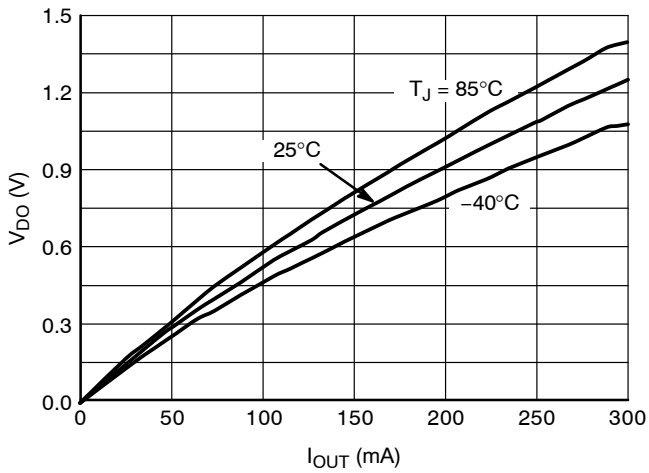

Figure 9. Dropout Voltage vs. Output Current  
3.0 V Version, ECO = L

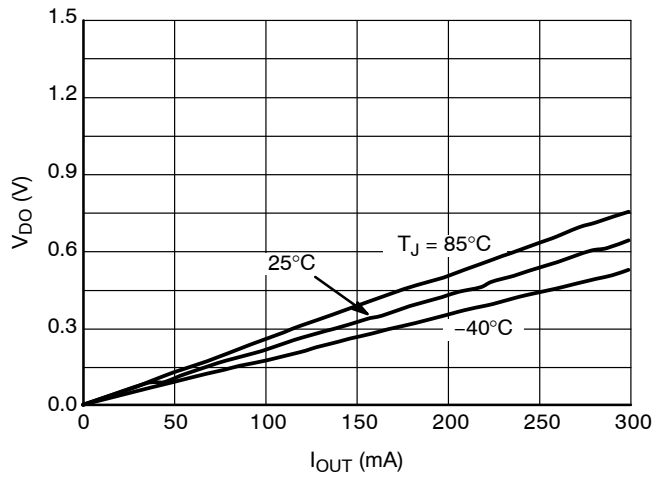

Figure 10. Dropout Voltage vs. Output Current  
3.0 V Version, ECO = H

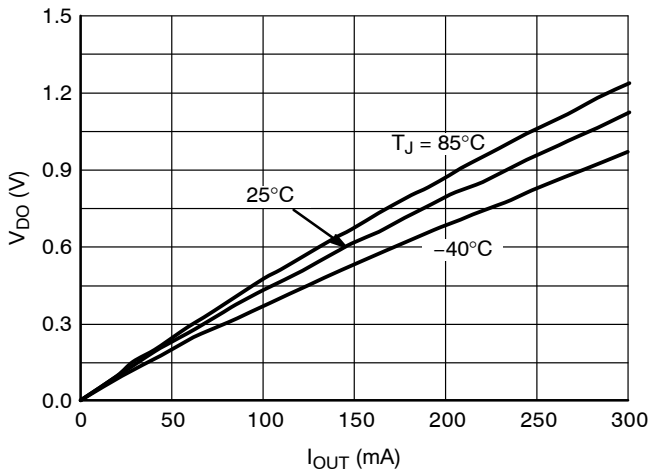

Figure 11. Dropout Voltage vs. Output Current  
3.3 V Version, ECO = L

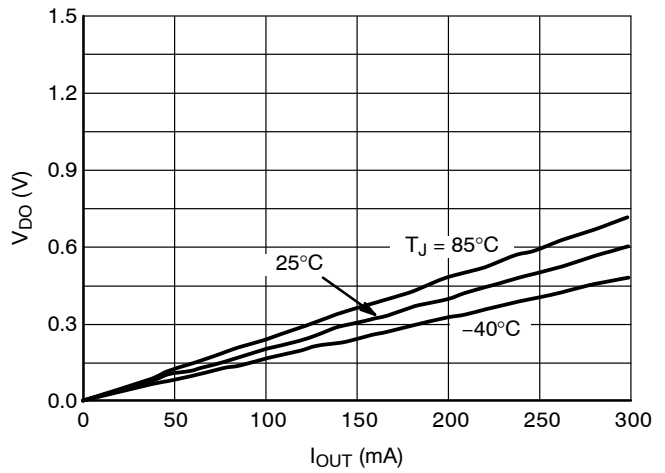

Figure 12. Dropout Voltage vs. Output Current  
3.3 V Version, ECO = H

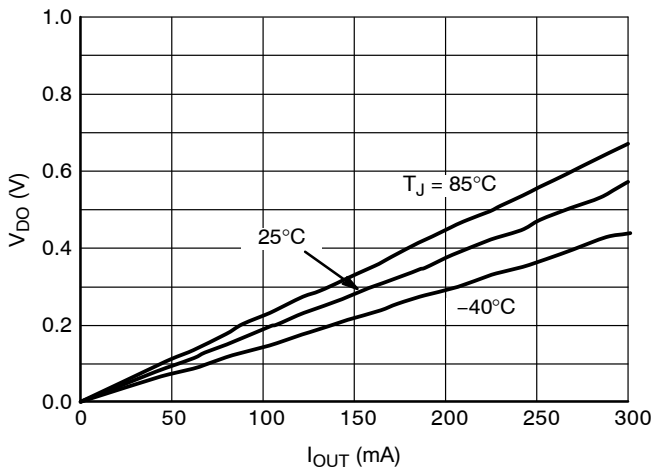

Figure 13. Dropout Voltage vs. Output Current  
5.0 V Version, ECO = L

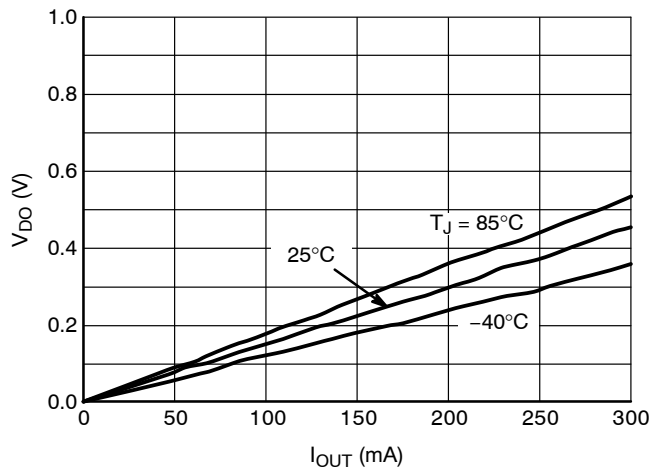

Figure 14. Dropout Voltage vs. Output Current  
5.0 V Version, ECO = H

TYPICAL CHARACTERISTICS

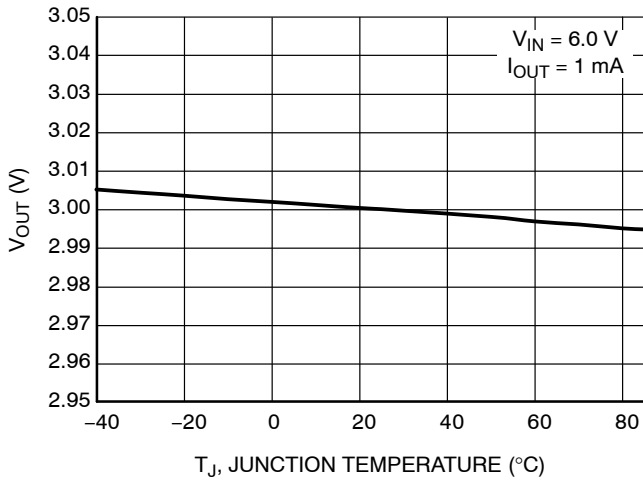

Figure 15. Output Voltage vs. Temperature, 3.0 V Version, ECO = L

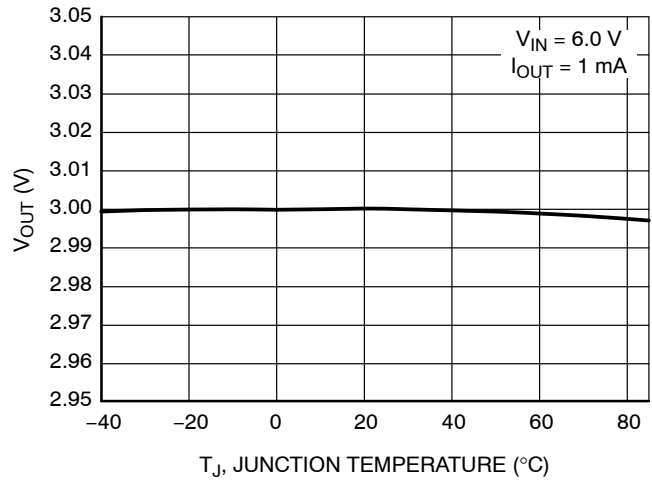

Figure 16. Output Voltage vs. Temperature, 3.0 V Version, ECO = H

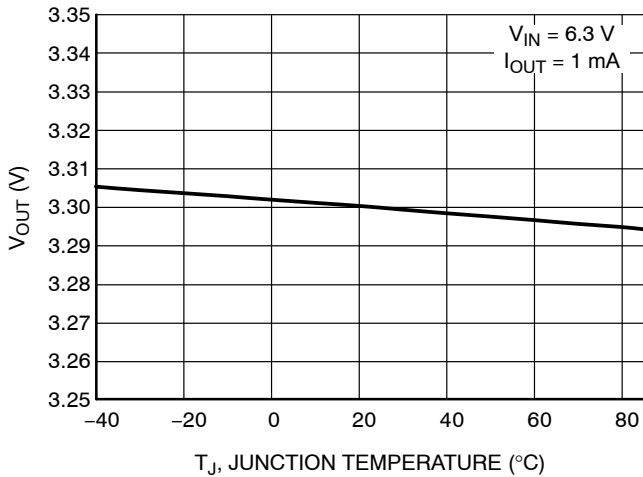

Figure 17. Output Voltage vs. Temperature, 3.3 V Version, ECO = L

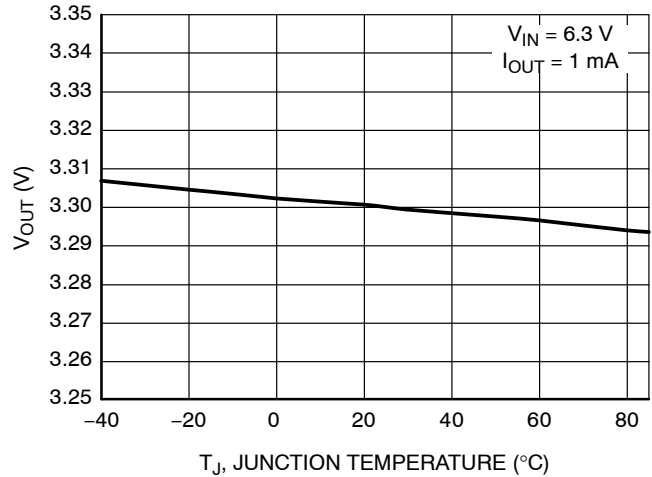

Figure 18. Output Voltage vs. Temperature, 3.3 V Version, ECO = H

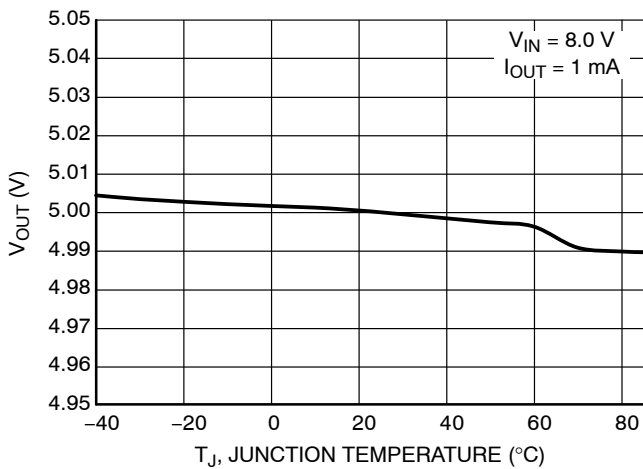

Figure 19. Output Voltage vs. Temperature, 5.0 V Version, ECO = L

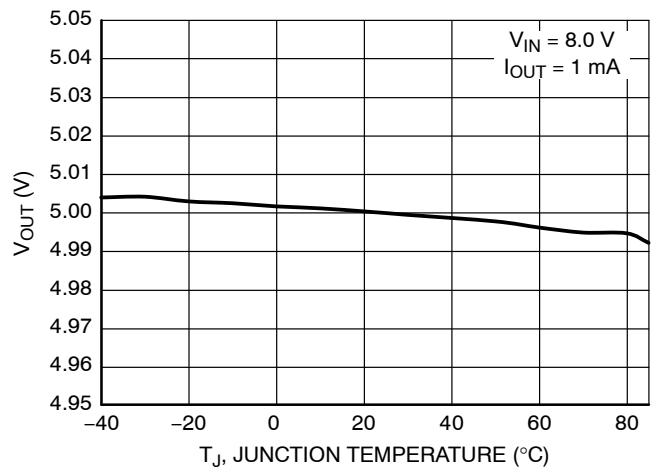

Figure 20. Output Voltage vs. Temperature, 5.0 V Version, ECO = H

TYPICAL CHARACTERISTICS

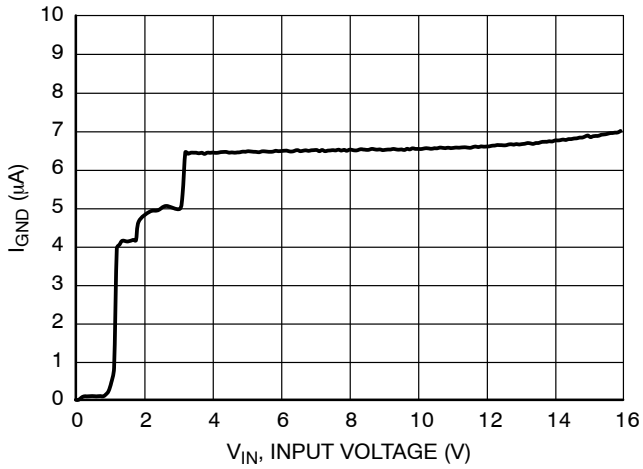

Figure 21. Supply Current vs. Input Voltage, 3.0 V Version, ECO = L

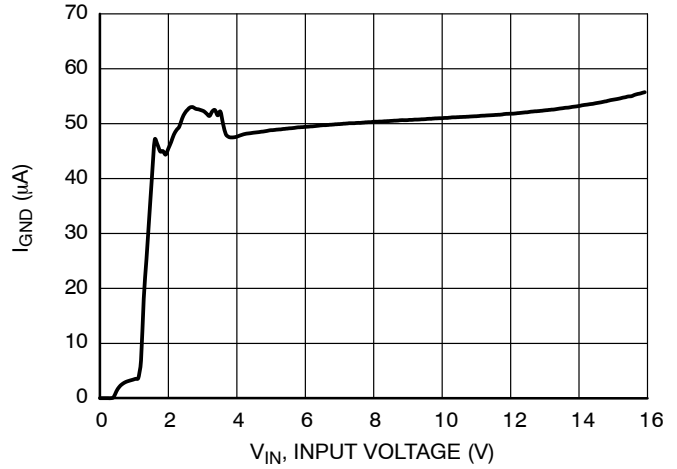

Figure 22. Supply Current vs. Input Voltage, 3.0 V Version, ECO = H

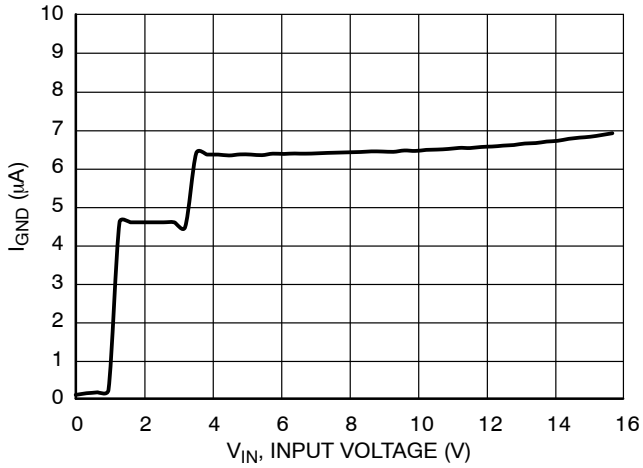

Figure 23. Supply Current vs. Input Voltage, 3.3 V Version, ECO = L

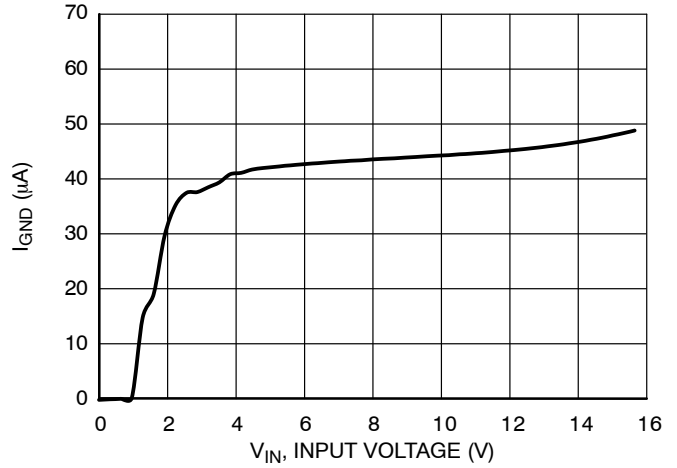

Figure 24. Supply Current vs. Input Voltage, 3.3 V Version, ECO = H

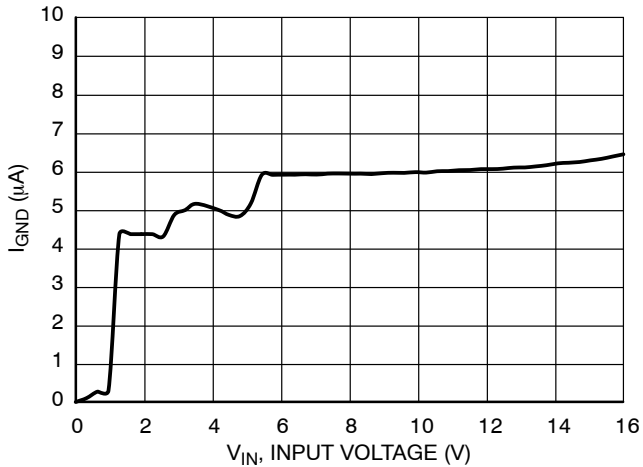

Figure 25. Supply Current vs. Input Voltage, 5.0 V Version, ECO = L

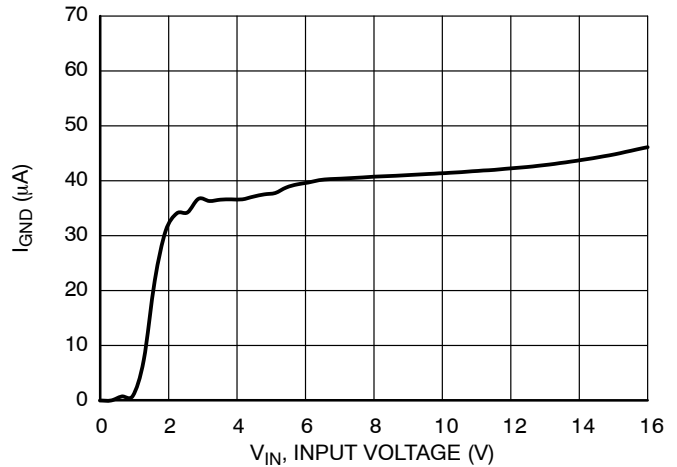

Figure 26. Supply Current vs. Input Voltage, 5.0 V Version, ECO = H



TYPICAL CHARACTERISTICS

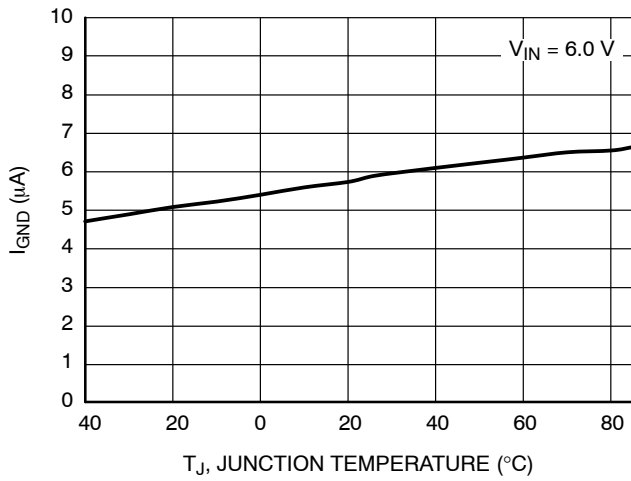

Figure 27. Supply Current vs. Temperature, 3.0 V Version, ECO = L

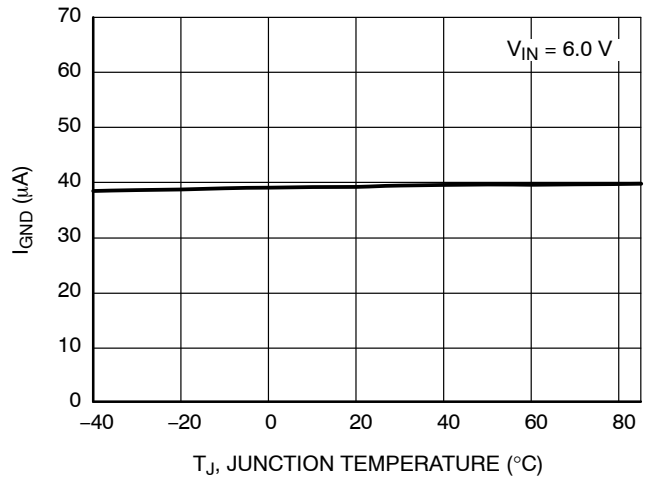

Figure 28. Supply Current vs. Temperature, 3.0 V Version, ECO = H

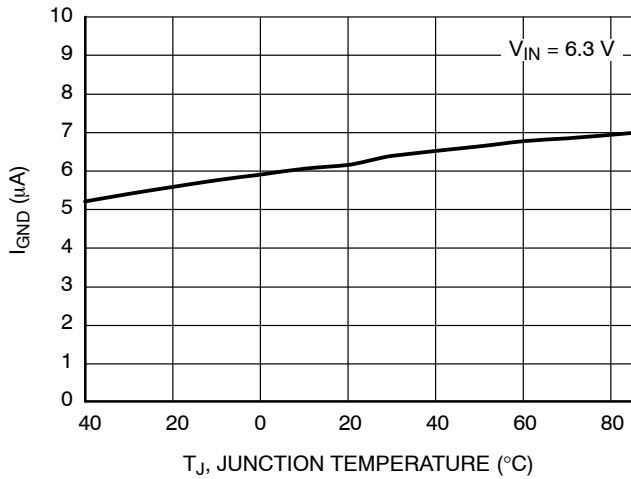

Figure 29. Supply Current vs. Temperature, 3.3 V Version, ECO = L

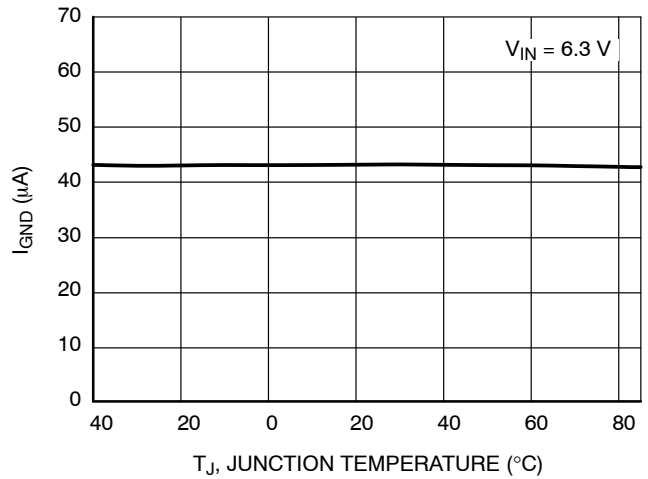

Figure 30. Supply Current vs. Temperature, 3.3 V Version, ECO = H

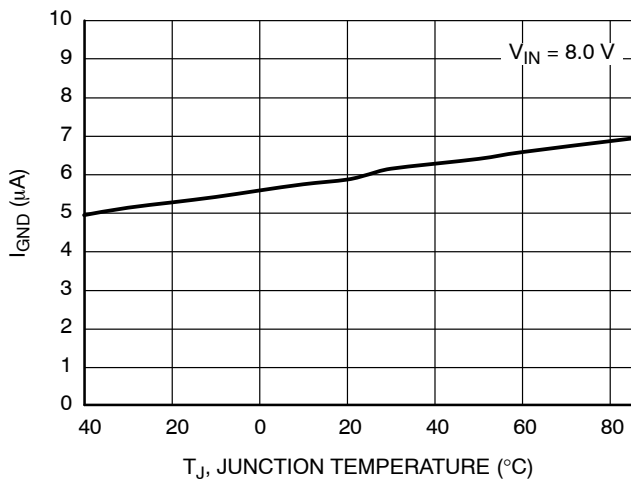

Figure 31. Supply Current vs. Temperature, 5.0 V Version, ECO = L

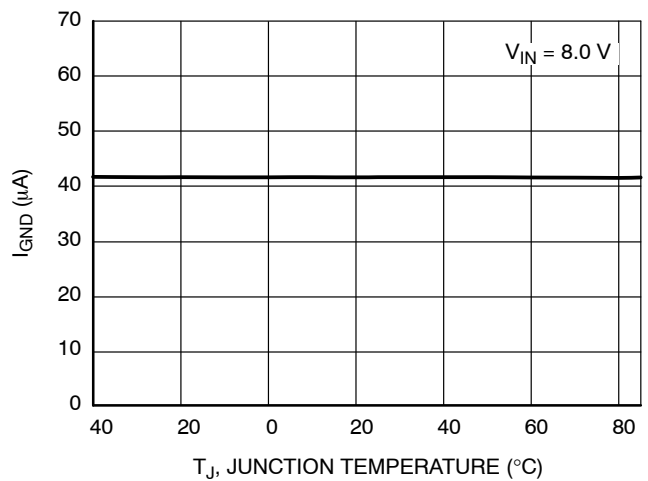

Figure 32. Supply Current vs. Temperature, 5.0 V Version, ECO = H

TYPICAL CHARACTERISTICS

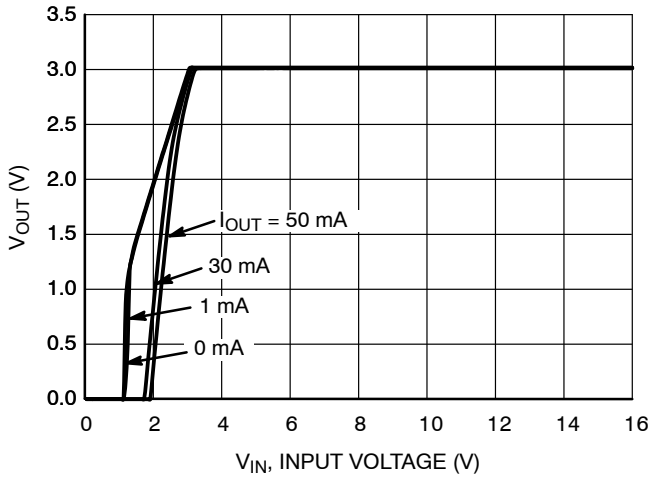

Figure 33. Output Voltage vs. Input Voltage, 3.0 V Version, ECO = L

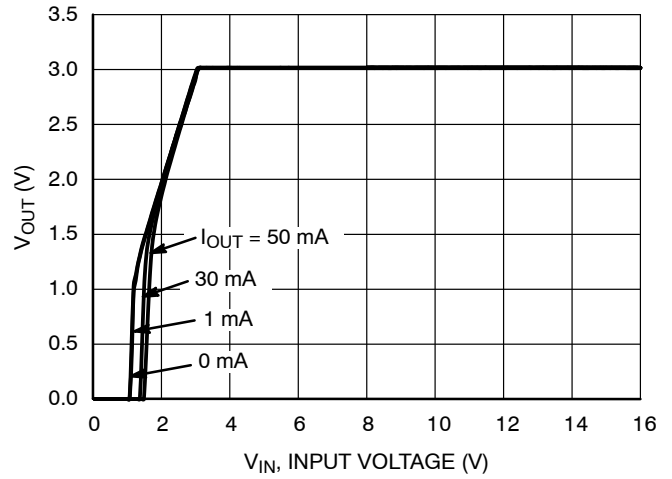

Figure 34. Output Voltage vs. Input Voltage, 3.0 V Version, ECO = H

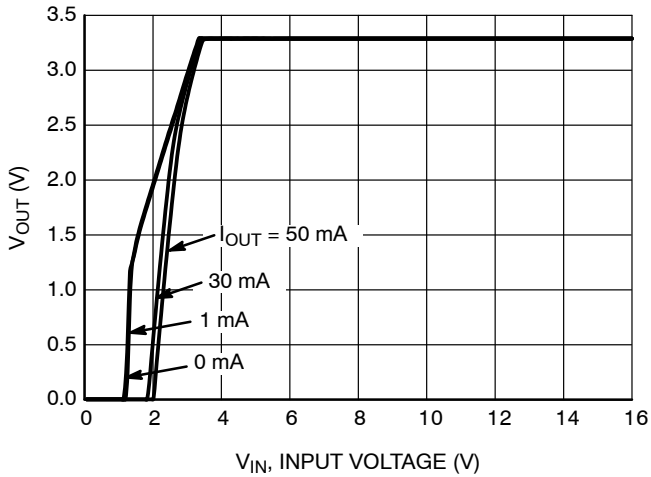

Figure 35. Output Voltage vs. Input Voltage, 3.3 V Version, ECO = L

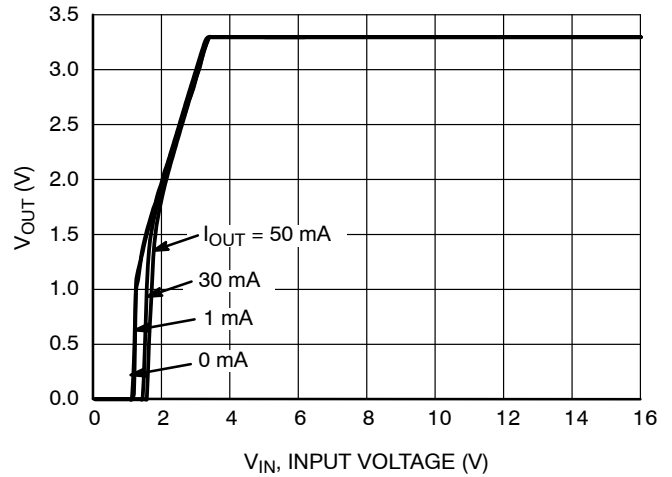

Figure 36. Output Voltage vs. Input Voltage, 3.3 V Version, ECO = H

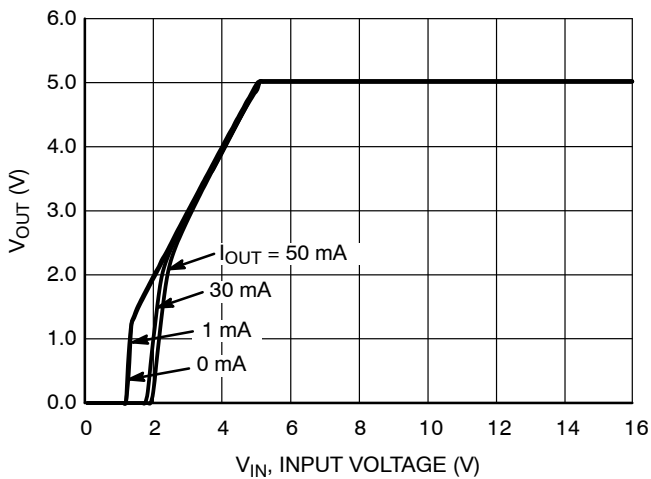

Figure 37. Output Voltage vs. Input Voltage, 5.0 V Version, ECO = L

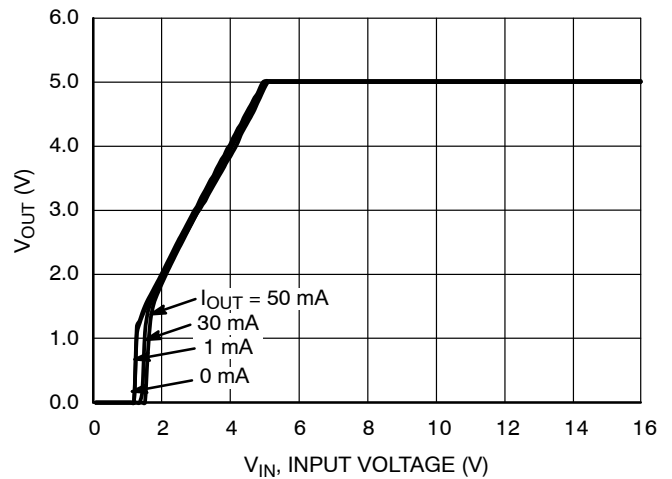

Figure 38. Output Voltage vs. Input Voltage, 5.0 V Version, ECO = H

TYPICAL CHARACTERISTICS

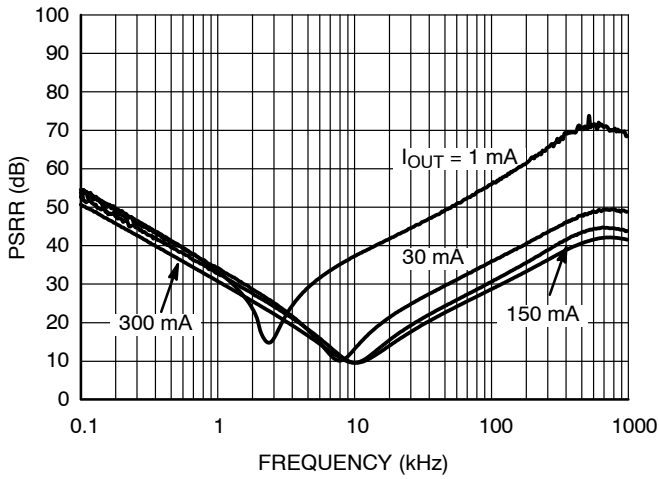

Figure 39. PSRR, 3.0 V Version,  $V_{IN} = 6.0 V$ , ECO = L

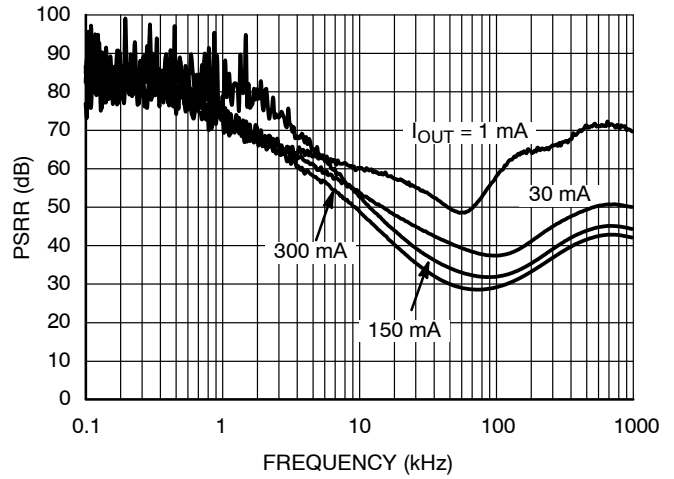

Figure 40. PSRR, 3.0 V Version,  $V_{IN} = 6.0 V$ , ECO = H

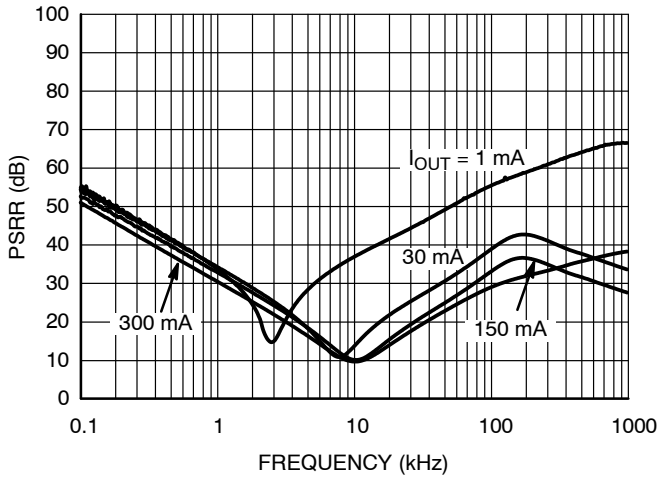

Figure 41. PSRR, 3.3 V Version,  $V_{IN} = 6.3 V$ , ECO = L

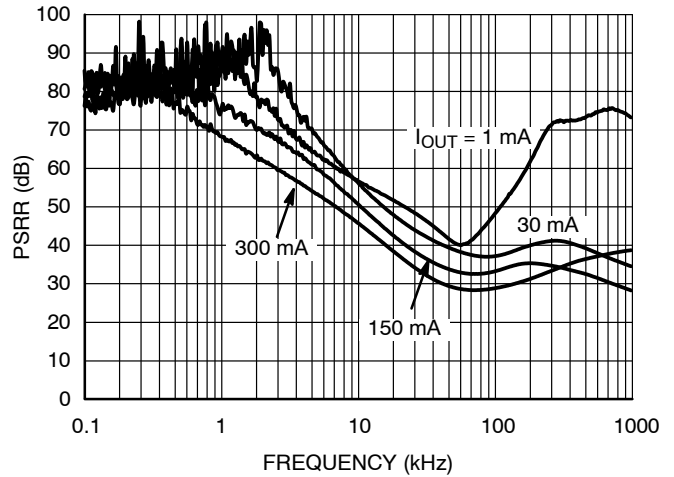

Figure 42. PSRR, 3.3 V Version,  $V_{IN} = 6.3 V$ , ECO = H

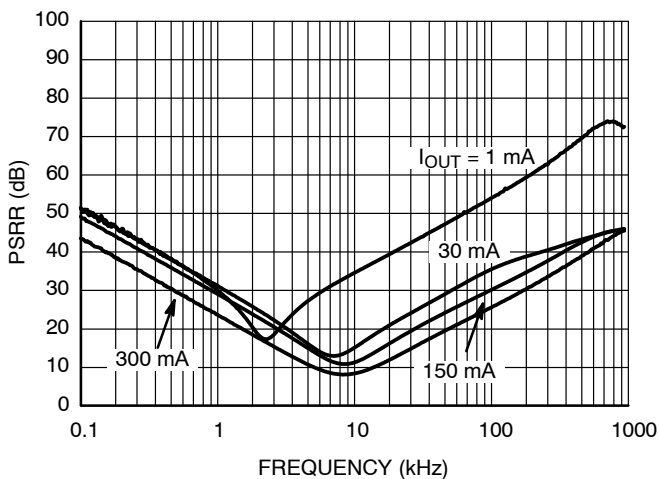

Figure 43. PSRR, 5.0 V Version,  $V_{IN} = 8.0 V$ , ECO = L

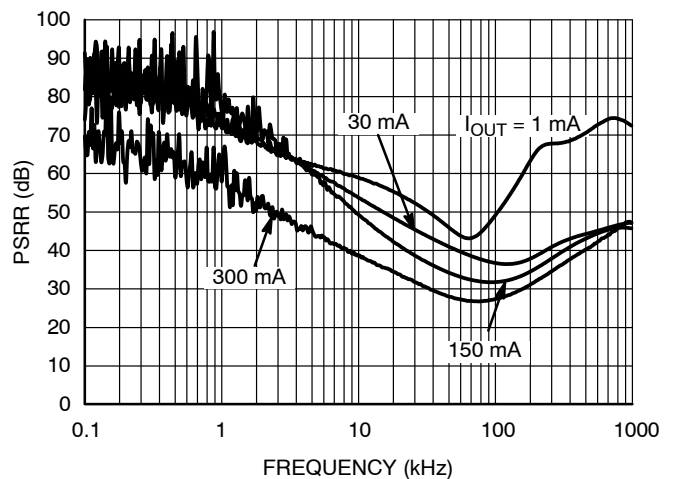

Figure 44. PSRR, 5.0 V Version,  $V_{IN} = 8.0 V$ , ECO = H

TYPICAL CHARACTERISTICS

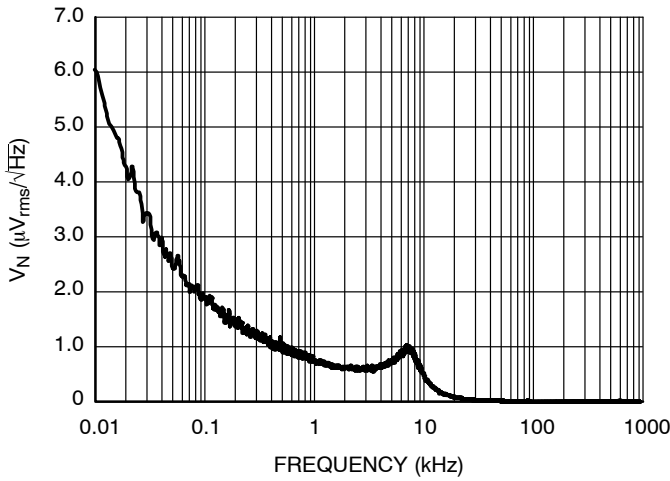

Figure 45. Output Voltage Noise, 3.0 V Version,  
 $V_{IN} = 6.0\text{ V}$ ,  $I_{OUT} = 30\text{ mA}$ ,  $ECO = L$

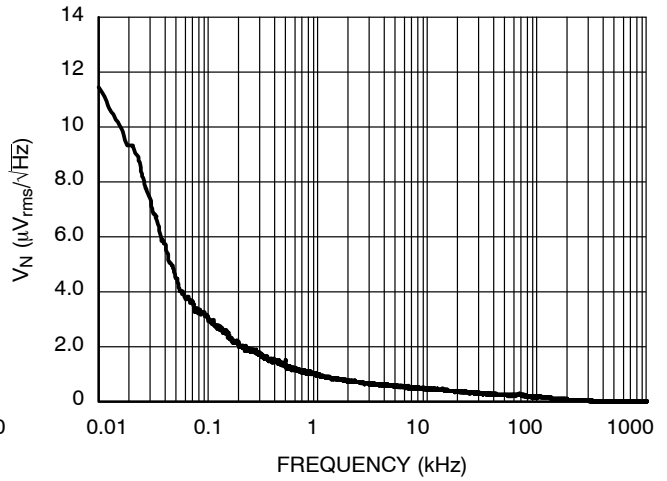

Figure 46. Output Voltage Noise, 3.0 V Version,  
 $V_{IN} = 6.0\text{ V}$ ,  $I_{OUT} = 30\text{ mA}$ ,  $ECO = H$

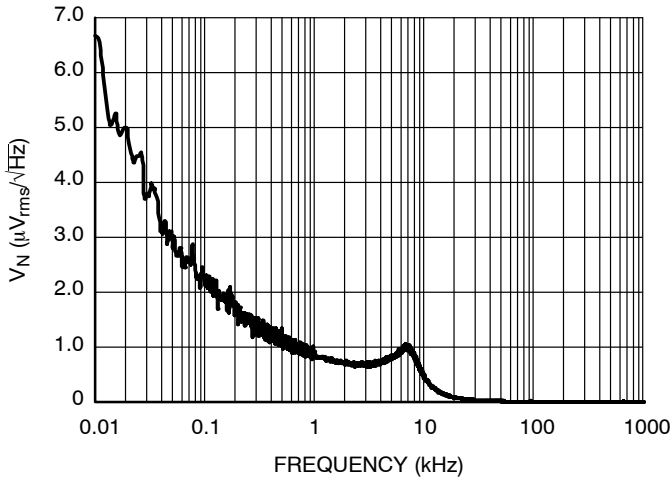

Figure 47. Output Voltage Noise, 3.3 V version,  
 $V_{IN} = 6.3\text{ V}$ ,  $I_{OUT} = 30\text{ mA}$ ,  $ECO = L$

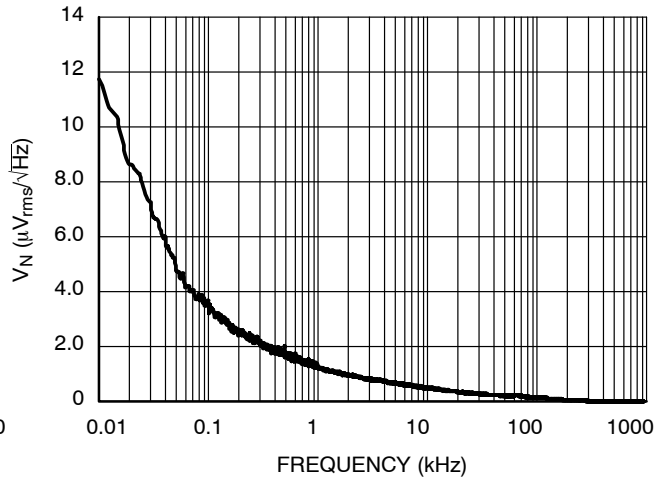

Figure 48. Output Voltage Noise, 3.3 V Version,  
 $V_{IN} = 6.3\text{ V}$ ,  $I_{OUT} = 30\text{ mA}$ ,  $ECO = H$

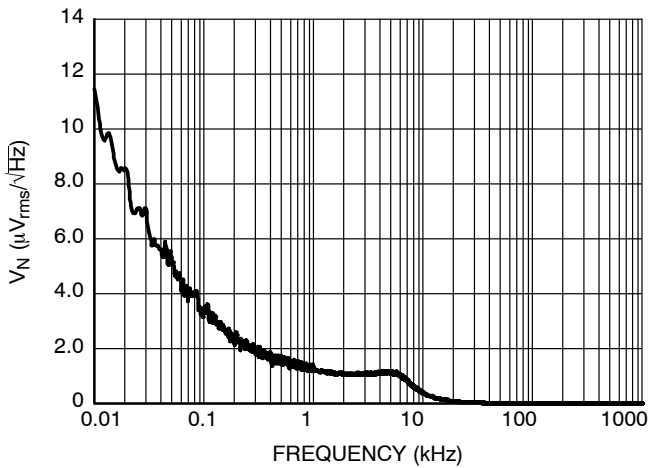

Figure 49. Output Voltage Noise, 5.0 V Version,  
 $V_{IN} = 8.0\text{ V}$ ,  $I_{OUT} = 30\text{ mA}$ ,  $ECO = L$

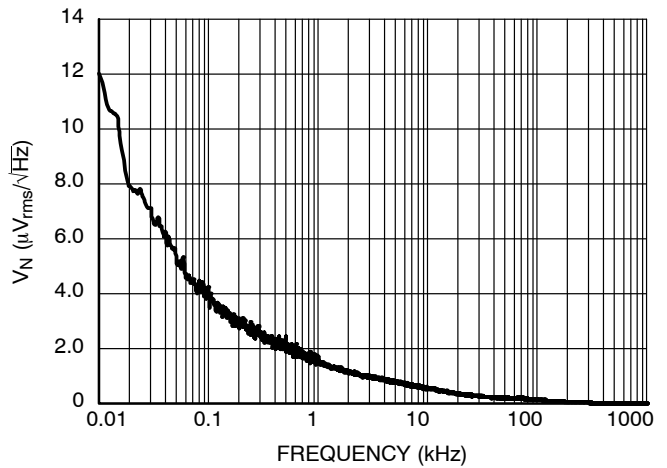
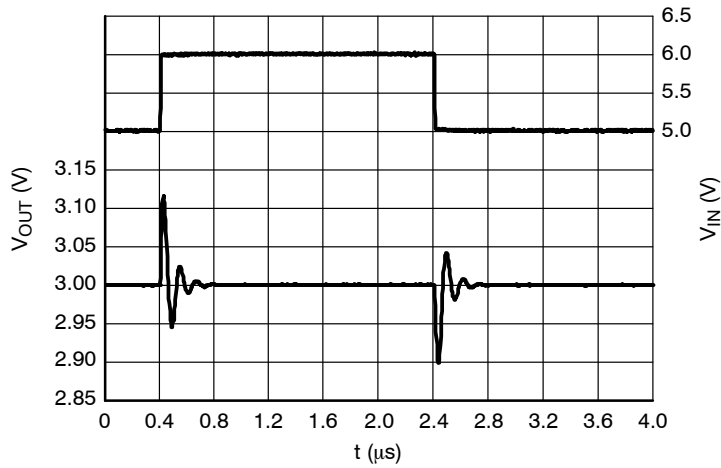

Figure 50. Output Voltage Noise, 5.0 V Version,  
 $V_{IN} = 8.0\text{ V}$ ,  $I_{OUT} = 30\text{ mA}$ ,  $ECO = H$

# NCP4626

## TYPICAL CHARACTERISTICS



**Figure 51. Line Transients, 3.0 V Version,  
 $t_R = t_F = 5 \mu s$ ,  $I_{OUT} = 30 \text{ mA}$ , ECO = L**

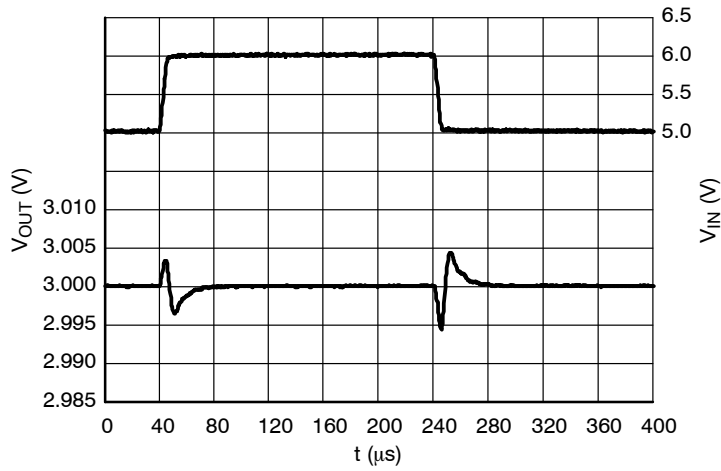

**Figure 52. Line Transients, 3.0 V Version,  
 $t_R = t_F = 5 \mu s$ ,  $I_{OUT} = 30 \text{ mA}$ , ECO = H**

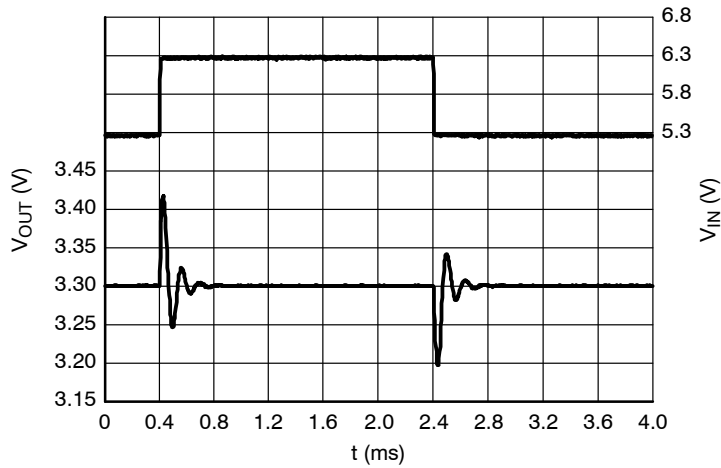

**Figure 53. Line Transients, 3.3 V Version,  
 $t_R = t_F = 5 \mu s$ ,  $I_{OUT} = 30 \text{ mA}$ , ECO = L**

# NCP4626

## TYPICAL CHARACTERISTICS

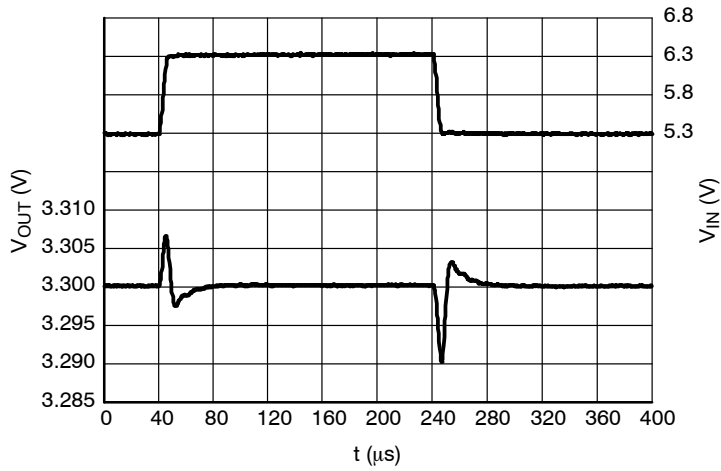

**Figure 54. Line Transients, 3.3 V Version,  
 $t_R = t_F = 5 \mu s$ ,  $I_{OUT} = 30 \text{ mA}$ , ECO = H**

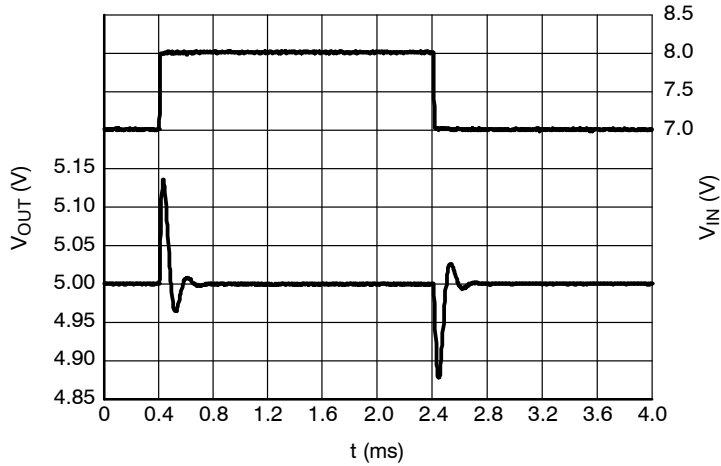

**Figure 55. Line Transients, 5.0 V Version,  
 $t_R = t_F = 5 \mu s$ ,  $I_{OUT} = 30 \text{ mA}$ , ECO = L**

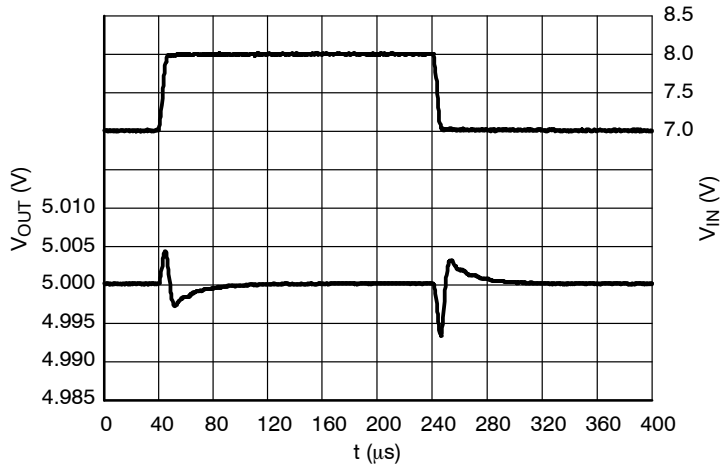

**Figure 56. Line Transients, 5.0 V Version,  
 $t_R = t_F = 5 \mu s$ ,  $I_{OUT} = 30 \text{ mA}$ , ECO = H**

# NCP4626

## TYPICAL CHARACTERISTICS

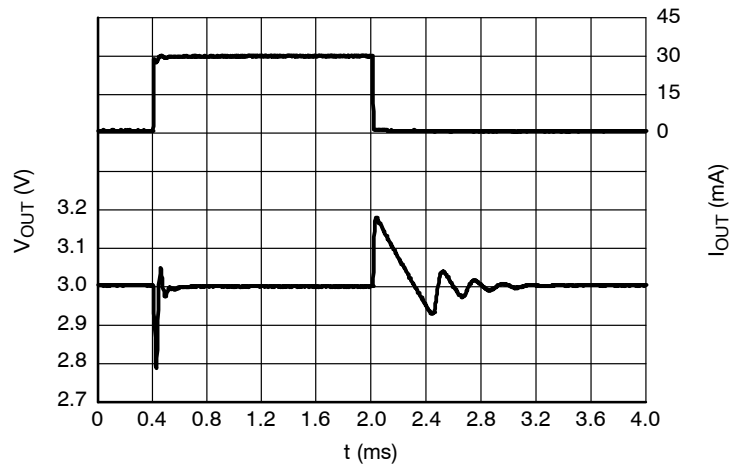

**Figure 57. Load Transients, 3.0 V Version,  
 $I_{OUT} = 1 - 30$  mA,  $t_R = t_F = 0.5$   $\mu$ s,  $V_{IN} = 6.0$  V,  
ECO = L**

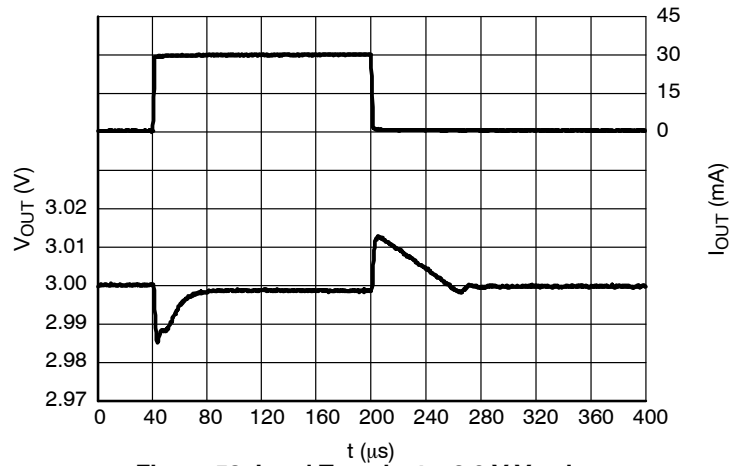

**Figure 58. Load Transients, 3.0 V Version,  
 $I_{OUT} = 1 - 30$  mA,  $t_R = t_F = 0.5$   $\mu$ s,  $V_{IN} = 6.0$  V,  
ECO = H**

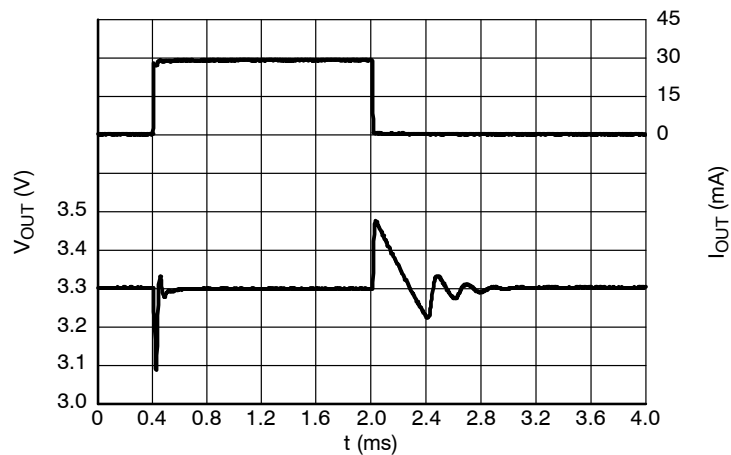

**Figure 59. Load Transients, 3.3 V version,  
 $I_{OUT} = 1 - 30$  mA,  $t_R = t_F = 0.5$   $\mu$ s,  $V_{IN} = 6.3$  V,  
ECO = L**

# NCP4626

## TYPICAL CHARACTERISTICS

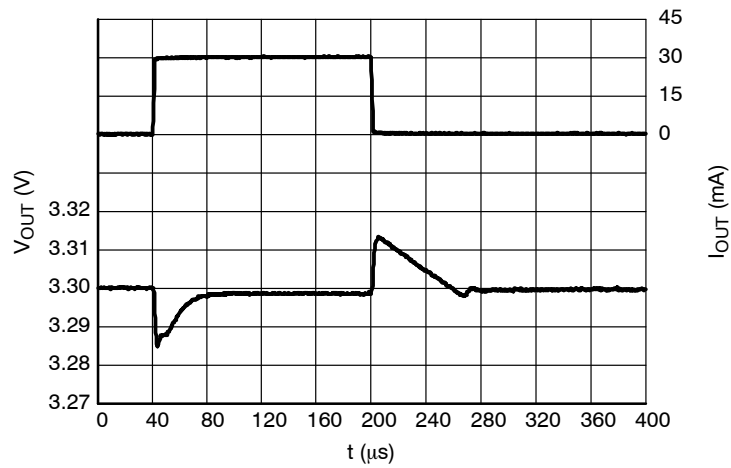

**Figure 60. Load Transients, 3.3 V Version,**  
 $I_{OUT} = 1 - 30 \text{ mA}$ ,  $t_R = t_F = 0.5 \mu\text{s}$ ,  $V_{IN} = 6.3 \text{ V}$ ,  
 $ECO = H$

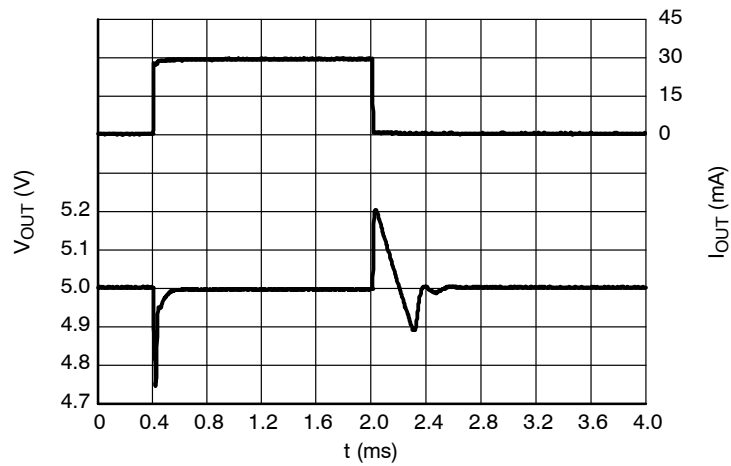

**Figure 61. Load Transients, 5.0 V Version,**  
 $I_{OUT} = 1 - 30 \text{ mA}$ ,  $t_R = t_F = 0.5 \mu\text{s}$ ,  $V_{IN} = 8.0 \text{ V}$ ,  
 $ECO = L$

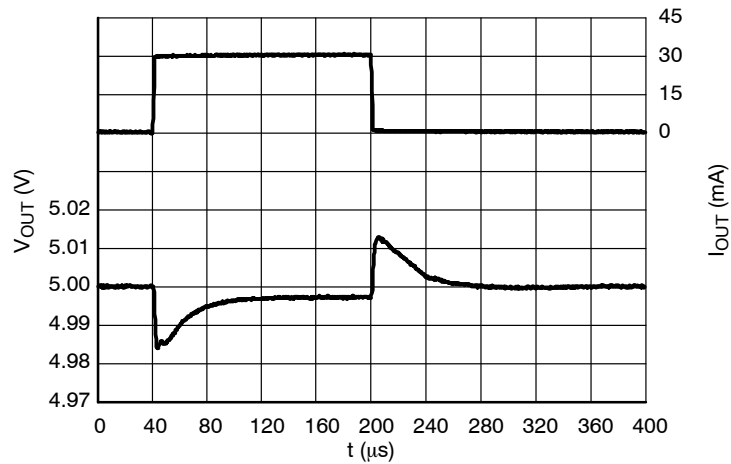
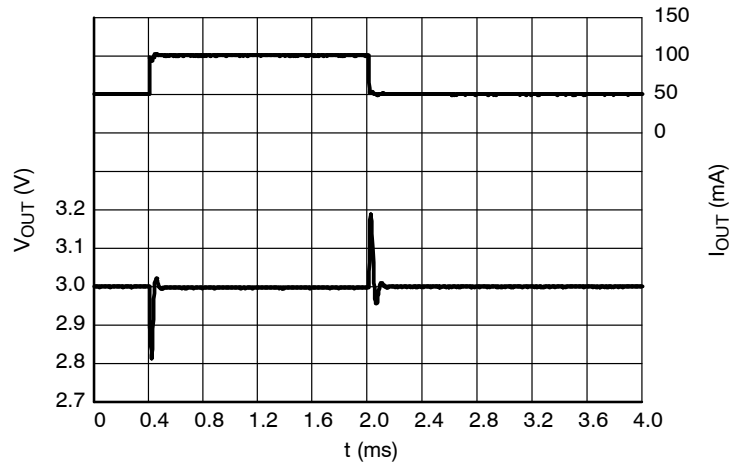

**Figure 62. Load Transients, 5.0 V Version,**  
 $I_{OUT} = 1 - 30 \text{ mA}$ ,  $t_R = t_F = 0.5 \mu\text{s}$ ,  $V_{IN} = 8.0 \text{ V}$ ,  
 $ECO = H$



# NCP4626

## TYPICAL CHARACTERISTICS



**Figure 63. Load Transients, 3.0 V Version,  
I<sub>OUT</sub> = 50 – 100 mA, t<sub>R</sub> = t<sub>F</sub> = 0.5 μs, V<sub>IN</sub> = 6.0 V,  
ECO = L**

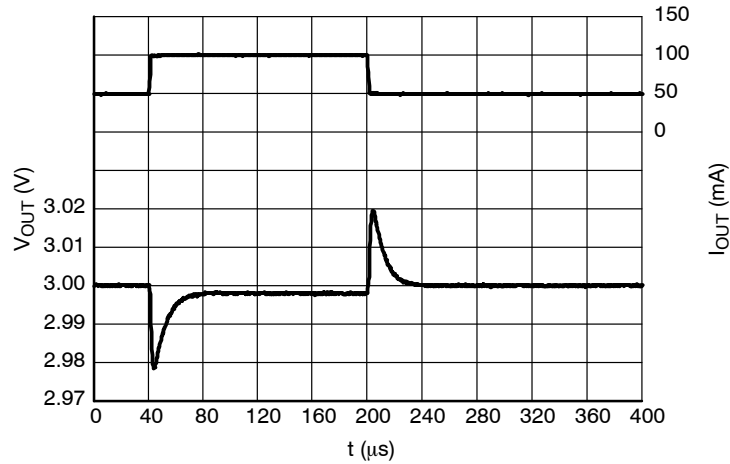

**Figure 64. Load Transients, 3.0 V Version,  
I<sub>OUT</sub> = 50 – 100 mA, t<sub>R</sub> = t<sub>F</sub> = 0.5 μs, V<sub>IN</sub> = 6.0 V,  
ECO = H**

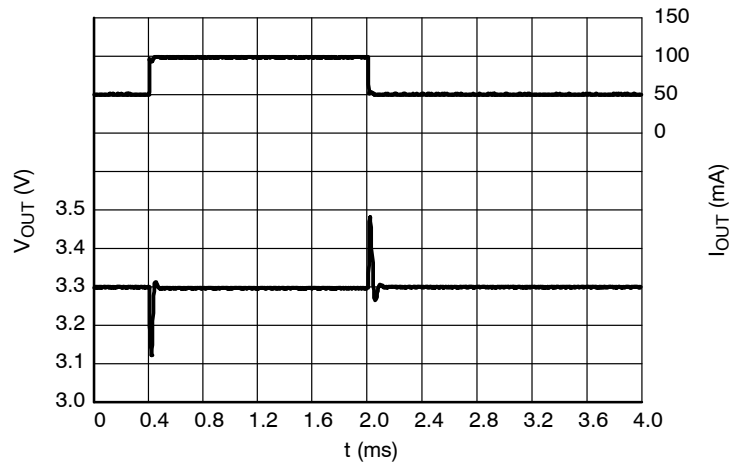

**Figure 65. Load Transients, 3.3 V Version,  
I<sub>OUT</sub> = 50 – 100 mA, t<sub>R</sub> = t<sub>F</sub> = 0.5 μs, V<sub>IN</sub> = 6.3 V,  
ECO = L**

# NCP4626

## TYPICAL CHARACTERISTICS

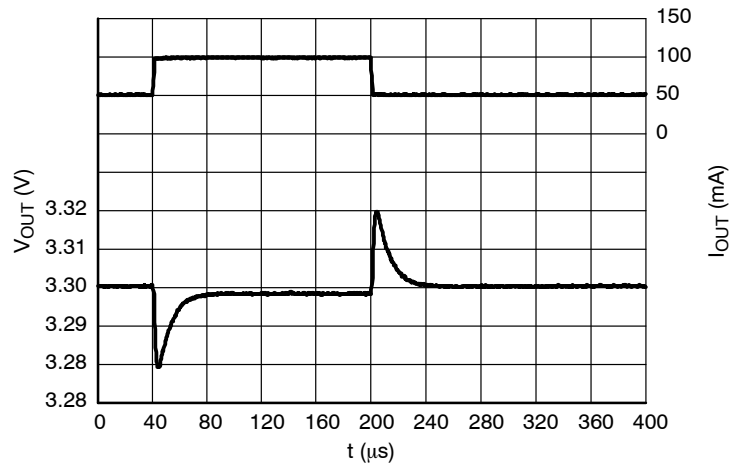

**Figure 66. Load Transients, 3.3 V Version,  
 $I_{OUT} = 50 - 100$  mA,  $t_R = t_F = 0.5 \mu$ s,  $V_{IN} = 6.3$  V,  
ECO = H**

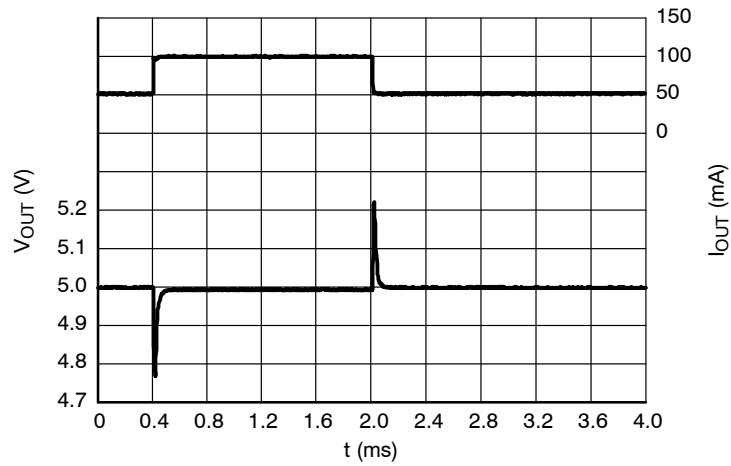

**Figure 67. Load Transients, 5.0 V Version,  
 $I_{OUT} = 50 - 100$  mA,  $t_R = t_F = 0.5 \mu$ s,  $V_{IN} = 8.0$  V,  
ECO = L**

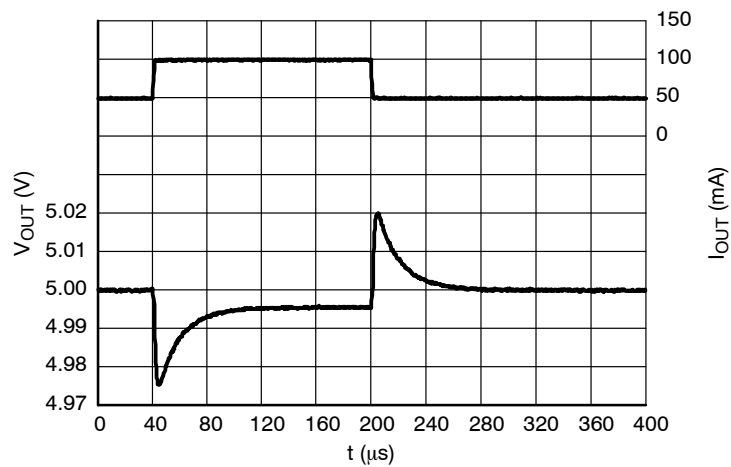

**Figure 68. Load Transients, 5.0 V Version,  
 $I_{OUT} = 50 - 100$  mA,  $t_R = t_F = 0.5 \mu$ s,  $V_{IN} = 8.0$  V,  
ECO = H**

# NCP4626

## TYPICAL CHARACTERISTICS

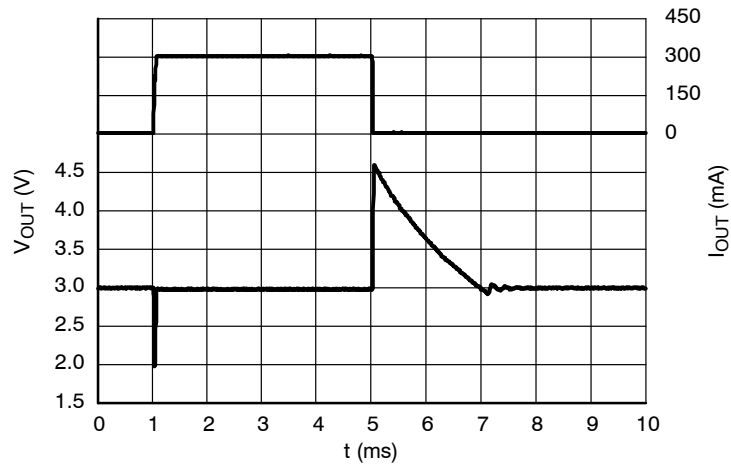

**Figure 69. Load Transients, 3.0 V Version,  
I<sub>OUT</sub> = 1 – 300 mA, t<sub>R</sub> = t<sub>F</sub> = 0.5 μs, V<sub>IN</sub> = 6.0 V,  
ECO = L**

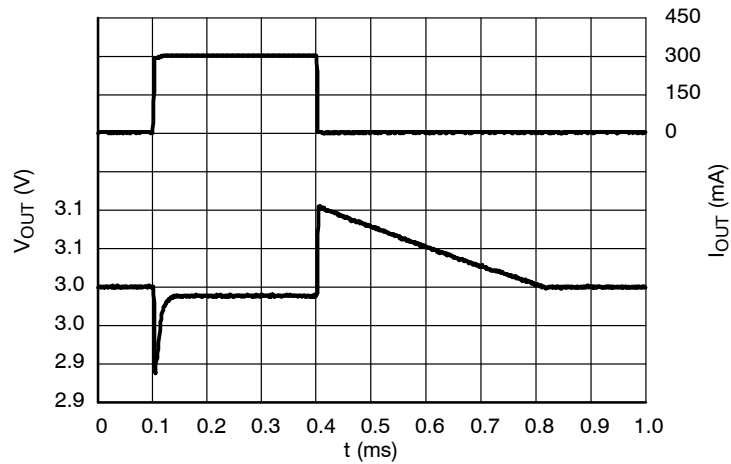

**Figure 70. Load Transients, 3.0 V Version,  
I<sub>OUT</sub> = 1 – 300 mA, t<sub>R</sub> = t<sub>F</sub> = 0.5 μs, V<sub>IN</sub> = 6.0 V,  
ECO = H**

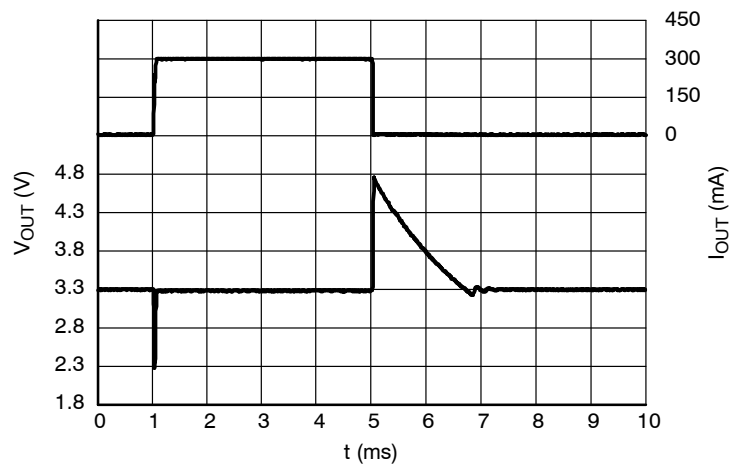

**Figure 71. Load Transients, 3.3 V Version,  
I<sub>OUT</sub> = 1 – 300 mA, t<sub>R</sub> = t<sub>F</sub> = 0.5 μs, V<sub>IN</sub> = 6.3 V,  
ECO = L**

# NCP4626

## TYPICAL CHARACTERISTICS

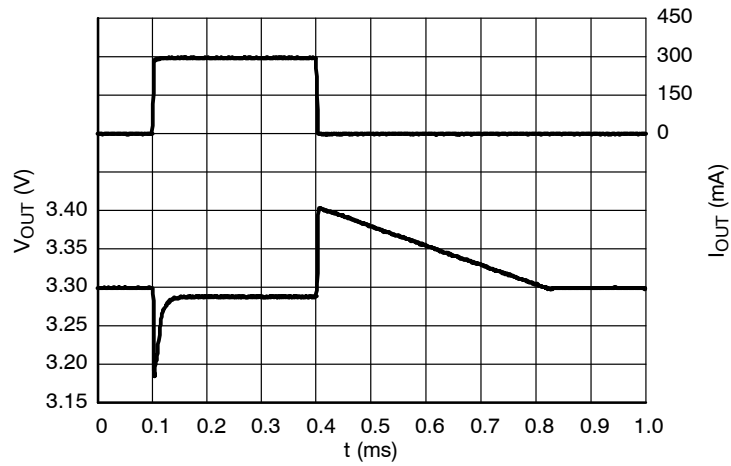

**Figure 72. Load Transients, 3.3 V Version,  
 $I_{OUT} = 1 - 300 \text{ mA}$ ,  $t_R = t_F = 0.5 \mu\text{s}$ ,  $V_{IN} = 6.3 \text{ V}$ ,  
ECO = H**

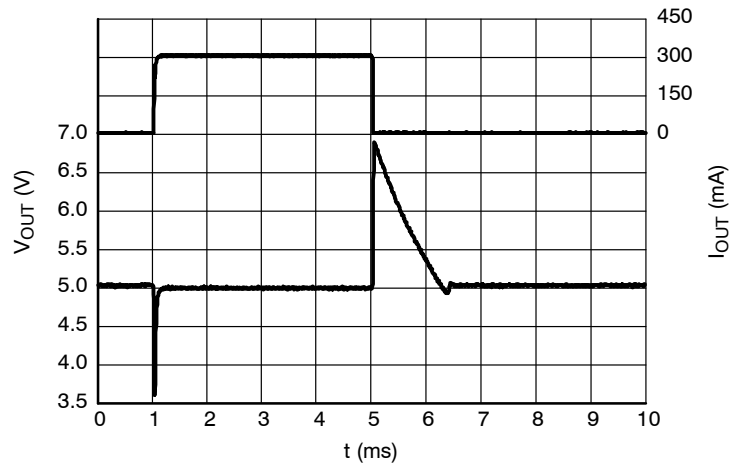

**Figure 73. Load Transients, 5.0 V Version,  
 $I_{OUT} = 1 - 300 \text{ mA}$ ,  $t_R = t_F = 0.5 \mu\text{s}$ ,  $V_{IN} = 8.0 \text{ V}$ ,  
ECO = L**

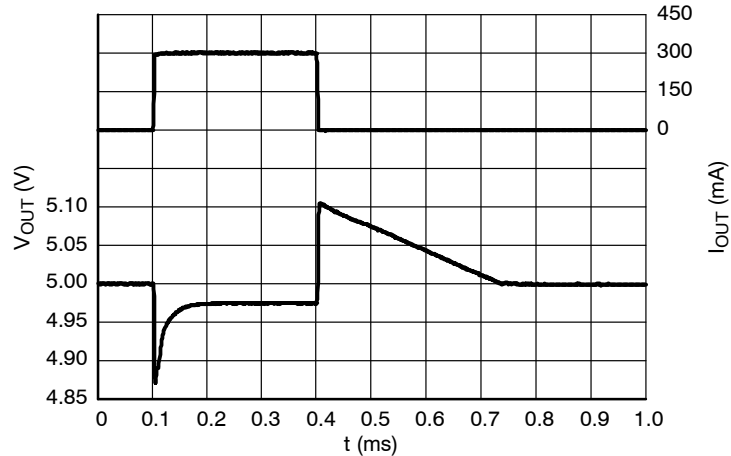

**Figure 74. Load Transients, 5.0 V Version,  
 $I_{OUT} = 1 - 300 \text{ mA}$ ,  $t_R = t_F = 0.5 \mu\text{s}$ ,  $V_{IN} = 8.0 \text{ V}$ ,  
ECO = H**

# NCP4626

## TYPICAL CHARACTERISTICS

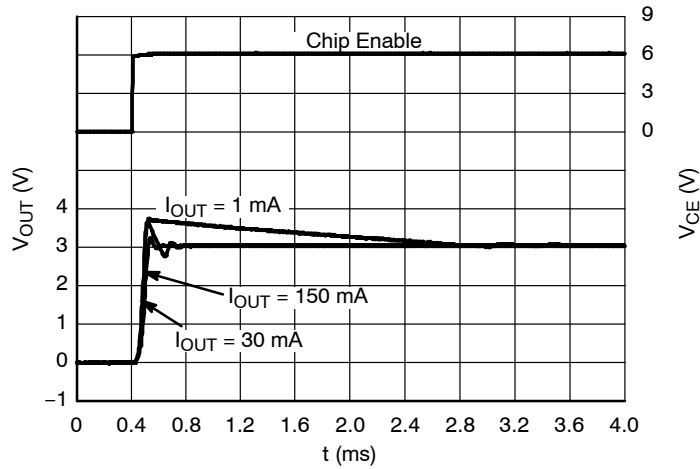

**Figure 75. Start-up, 3.0 V Version,  $V_{IN} = 6.0$  V,  $ECO = L$**

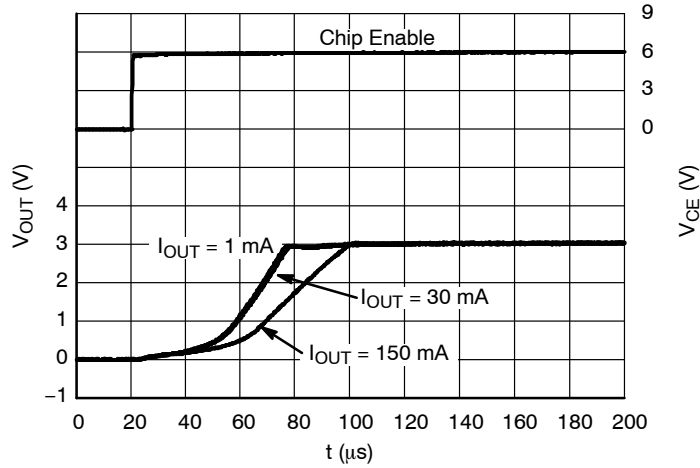

**Figure 76. Start-up, 3.0 V Version,  $V_{IN} = 6.0$  V,  $ECO = H$**

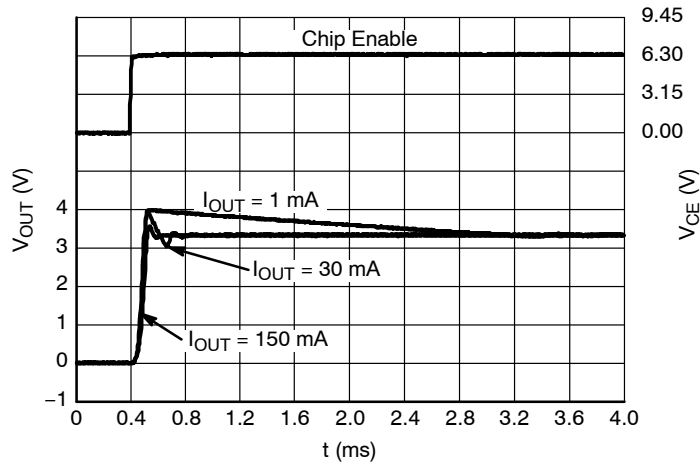

**Figure 77. Start-up, 3.3 V Version,  $V_{IN} = 6.3$  V,  $ECO = L$**

# NCP4626

## TYPICAL CHARACTERISTICS

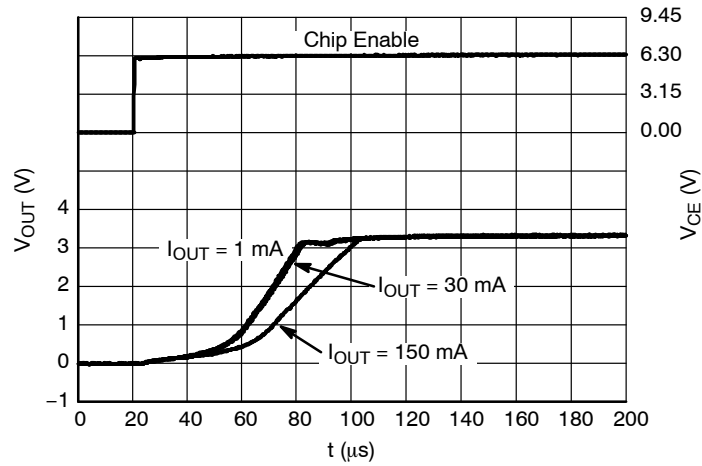

Figure 78. Start-up, 3.3 V Version,  $V_{IN} = 6.3\text{ V}$ ,  $ECO = H$

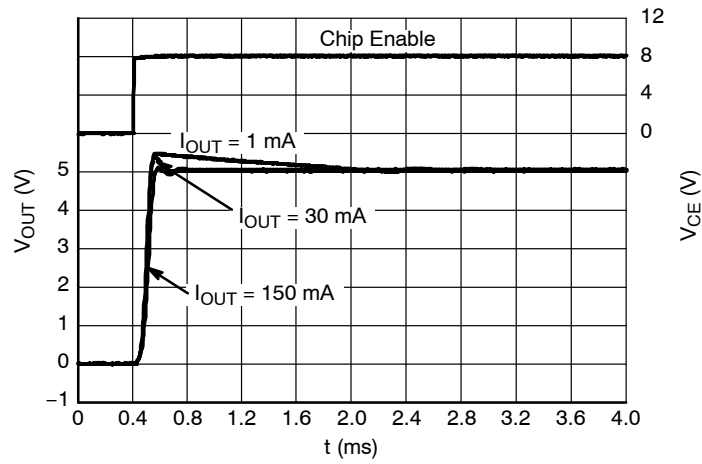

Figure 79. Start-up, 5.0 V Version,  $V_{IN} = 8.0\text{ V}$ ,  $ECO = L$

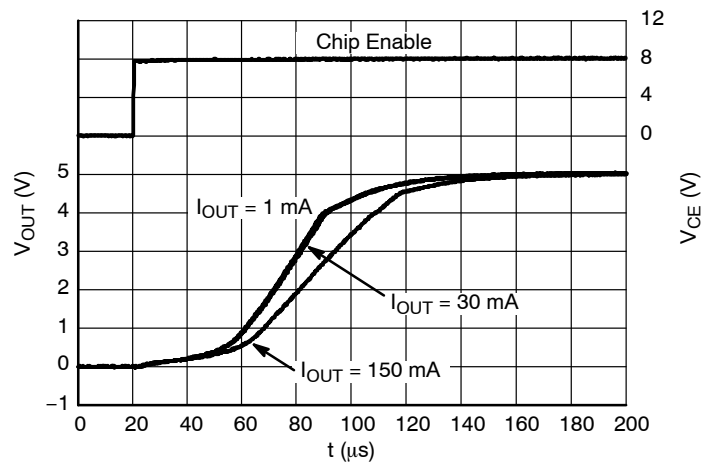

Figure 80. Start-up, 5.0 V Version,  $V_{IN} = 8.0\text{ V}$ ,  $ECO = H$

# NCP4626

## TYPICAL CHARACTERISTICS

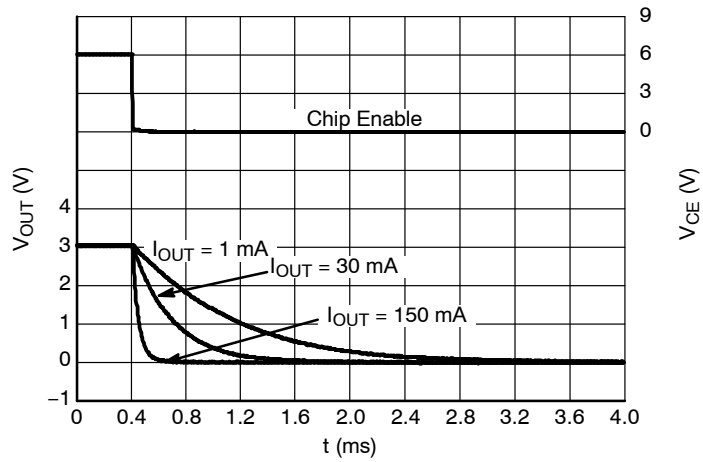

Figure 81. Shutdown, 3.0 V Version D,  
 $V_{IN} = 6.0$  V

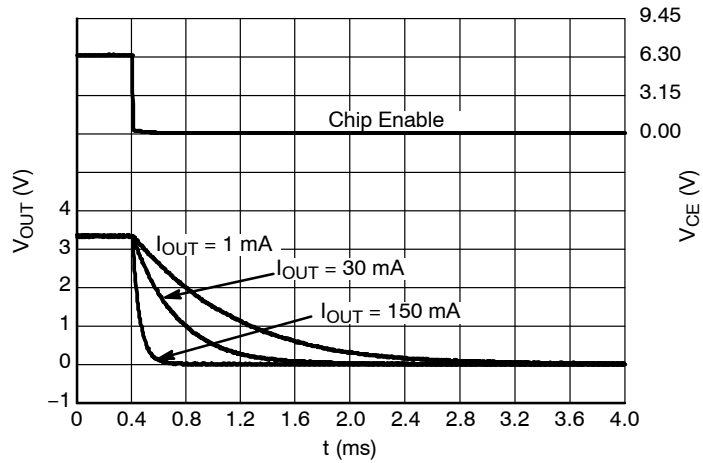

Figure 82. Shutdown, 3.3 V Version D,  
 $V_{IN} = 6.3$  V

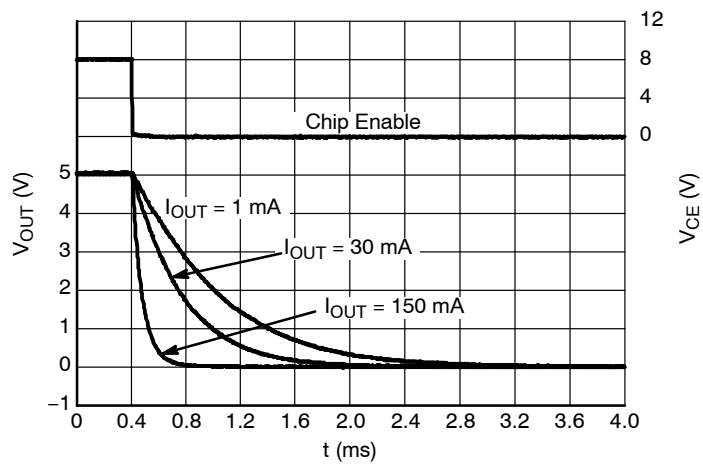

Figure 83. Shutdown, 5.0 V Version D,  
 $V_{IN} = 8.0$  V

## APPLICATION INFORMATION

A typical application circuit for NCP4626 series is shown in Figure 84.

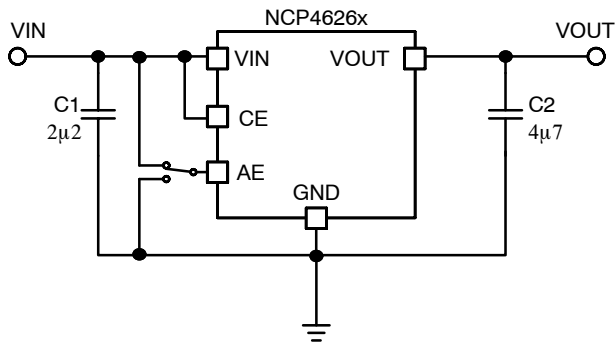

Figure 84. Typical Application Schematic

#### Input Decoupling Capacitor (C1)

A 2.2  $\mu\text{F}$  (or larger) ceramic input decoupling capacitor should be connected as close as possible to the input and ground pin of the NCP4626. Higher capacitor values and lower ESR improves line transient response.

#### Output Decoupling Capacitor (C2)

A 4.7  $\mu\text{F}$  (or larger) ceramic output decoupling capacitor is sufficient to achieve stable operation of the IC. It is necessary to use a capacitor with good frequency characteristics and low ESR. The capacitor should be connected as close as possible to the output and ground pins. Larger capacitor values and lower ESR improves dynamic parameters.

#### Enable Operation

The enable pin CE may be used to turn the regulator on and off. The IC is switched on when a high level voltage is applied to the CE pin. The enable pin has an internal pull down resistor. If the enable function is not needed, connect the CE pin to VIN.

#### Output Discharger

The D version of the NCP4626 includes a transistor between VOUT and GND that is used for faster discharging of the output capacitor. This function is activated when the IC goes into disable mode.

#### Current Limit

This regulator includes fold-back type current limit circuit. This type of protection doesn't limit current up to

current capability in normal operation, but when over current occurs, output voltage and current decrease until over current condition ends. Typical characteristics of this protection type can be observed in the Output Voltage versus Output Current graphs shown in the typical characteristics chapter of this datasheet.

#### ECO Function

The IC can be switched between two modes by ECO pin. One mode is low power mode, where IC's self current consumption is low, but IC has slower dynamic behavior or in to fast mode, where current consumption is higher, but the IC has better dynamic response and lower dropout voltage. Do not leave the ECO pin unconnected or between  $V_{CEH}$  and  $V_{CEL}$  voltage levels as this may cause indefinite and unexpected currents flows internally.

#### Thermal Considerations

As power across the IC increases, it might become necessary to provide some thermal relief. The maximum power dissipation supported by the device is dependent upon board design and layout. Mounting pad configuration on the PCB, the board material, and the ambient temperature effect the rate of temperature rise for the part. That is to say, when the device has good thermal conductivity through the PCB, the junction temperature will be relatively low with high power dissipation applications.

The IC includes internal thermal shutdown circuit that stops the regulator operating if the junction temperature is higher than 150°C. After shutdown, when the junction temperature decreases below 130°C, the voltage regulator would restarts. As long as the high power dissipation condition exists, the regulator will start and stop repeatedly to protect itself against overheating. Care should be taken in the PCB layout to try to avoid this temperature cycling condition.

#### PCB Layout

Make the VIN and GND lines as large as possible. If their impedance is high, noise pickup or unstable operation may result. Connect capacitors C1 and C2 as close as possible to the IC, and make wiring as short as possible. The tab under the XDFN package is internally connected to GND: it is best practice to connect it to GND on the PCB, but leaving it unconnected is also acceptable.



# NCP4626

## ORDERING INFORMATION

Device	Nominal Output Voltage	Description	Marking	Package	Shipping <sup>†</sup>
NCP4626DSN030T1G	3.0 V	Auto discharge	630	SOT23 (Pb-Free)	3000 / Tape & Reel
NCP4626DSN033T1G	3.3 V	Auto discharge	633	SOT23 (Pb-Free)	3000 / Tape & Reel
NCP4626DSN045T1G	4.5 V	Auto discharge	645	SOT23 (Pb-Free)	3000 / Tape & Reel
NCP4626DSN050T1G	5.0 V	Auto discharge	650	SOT23 (Pb-Free)	3000 / Tape & Reel
NCP4626HSN030T1G	3.0 V	Standard	430	SOT23 (Pb-Free)	3000 / Tape & Reel
NCP4626HSN033T1G	3.3 V	Standard	433	SOT23 (Pb-Free)	3000 / Tape & Reel
NCP4626HSN045T1G	4.5 V	Standard	445	SOT23 (Pb-Free)	3000 / Tape & Reel
NCP4626HSN050T1G	5.0 V	Standard	450	SOT23 (Pb-Free)	3000 / Tape & Reel
NCP4626DMX030TCG	3.0 V	Auto discharge	CH11	XDFN (Pb-Free)	5000 / Tape & Reel
NCP4626DMX033TCG	3.3 V	Auto discharge	CH14	XDFN (Pb-Free)	5000 / Tape & Reel
NCP4626DMX045TCG	4.5 V	Auto discharge	CH26	XDFN (Pb-Free)	5000 / Tape & Reel
NCP4626DMX050TCG	5.0 V	Auto discharge	CH31	XDFN (Pb-Free)	5000 / Tape & Reel
NCP4626HMX030TCG	3.0 V	Standard	CF11	XDFN (Pb-Free)	5000 / Tape & Reel
NCP4626HMX033TCG	3.3 V	Standard	CF14	XDFN (Pb-Free)	5000 / Tape & Reel
NCP4626HMX045TCG	4.5 V	Standard	CF26	XDFN (Pb-Free)	5000 / Tape & Reel
NCP4626HMX050TCG	5.0 V	Standard	CF31	XDFN (Pb-Free)	5000 / Tape & Reel

†For information on tape and reel specifications, including part orientation and tape sizes, please refer to our Tape and Reel Packaging Specifications Brochure, BRD8011/D.

\*To order other package and voltage variants, please contact your ON Semiconductor sales representative.

# NCP4626

## PACKAGE DIMENSIONS

XDFN6 1.6x1.6, 0.5P  
CASE 711AC-01  
ISSUE O

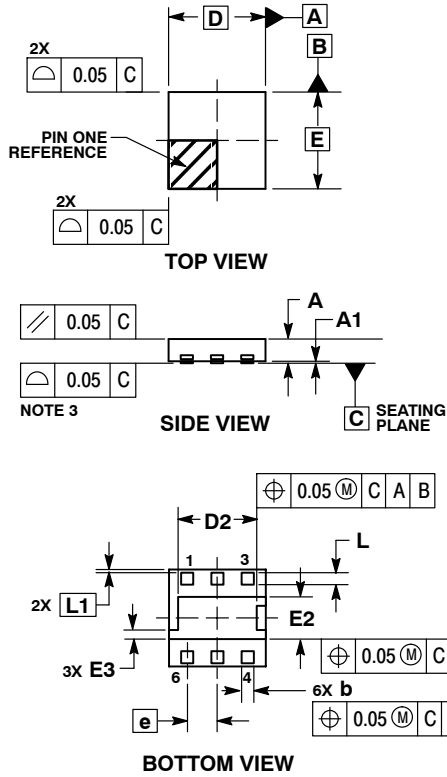

**NOTES:**

1. DIMENSIONING AND TOLERANCING PER ASME Y14.5M, 1994.
2. CONTROLLING DIMENSION: MILLIMETERS.
3. COPLANARITY APPLIES TO THE EXPOSED PAD AS WELL AS THE TERMINALS.

MILLIMETERS		
DIM	MIN	MAX
A	---	0.40
A1	0.00	0.05
b	0.15	0.25
D	1.60 BSC	
D2	1.25	1.35
E	1.60 BSC	
E2	0.65	0.75
E3	0.15 REF	
e	0.50 BSC	
L	0.15	0.25
L1	0.05 BSC	

**RECOMMENDED MOUNTING FOOTPRINT\***

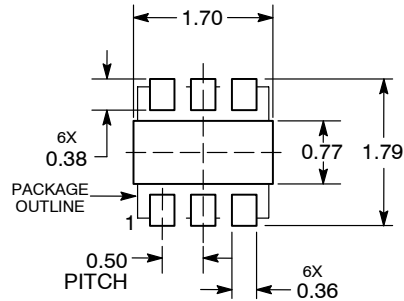

DIMENSIONS: MILLIMETERS

\*For additional information on our Pb-Free strategy and soldering details, please download the ON Semiconductor Soldering and Mounting Techniques Reference Manual, SOLDERRM/D.

# NCP4626

## PACKAGE DIMENSIONS

SOT-89, 5 LEAD  
CASE 528AB-01  
ISSUE O

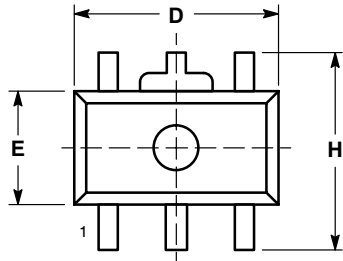

TOP VIEW

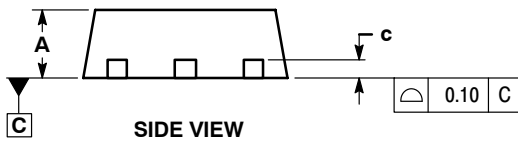

SIDE VIEW

NOTES:

1. DIMENSIONING AND TOLERANCING PER ASME Y14.5M, 1994.
2. CONTROLLING DIMENSION: MILLIMETERS.
3. LEAD THICKNESS INCLUDES LEAD FINISH.
4. DIMENSIONS D AND E DO NOT INCLUDE MOLD FLASH, PROTRUSIONS, OR GATE BURRS.
5. DIMENSIONS L, L2, L3, L4, L5, AND H ARE MEASURED AT DATUM PLANE C.

DIM	MILLIMETERS	
	MIN	MAX
A	1.40	1.60
b	0.32	0.52
b1	0.37	0.57
c	0.30	0.50
D	4.40	4.60
D2	1.40	1.80
E	2.40	2.60
e	1.40	1.60
H	4.25	4.45
L	1.10	1.50
L2	0.80	1.20
L3	0.95	1.35
L4	0.65	1.05
L5	0.20	0.60

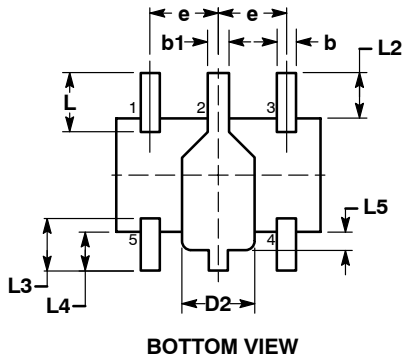

BOTTOM VIEW

### RECOMMENDED MOUNTING FOOTPRINT\*

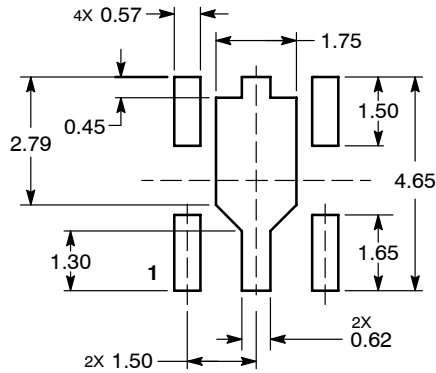

DIMENSIONS: MILLIMETERS

\*For additional information on our Pb-Free strategy and soldering details, please download the ON Semiconductor Soldering and Mounting Techniques Reference Manual, SOLDERRM/D.

# NCP4626

## PACKAGE DIMENSIONS

SOT-23  
CASE 1212-01  
ISSUE O

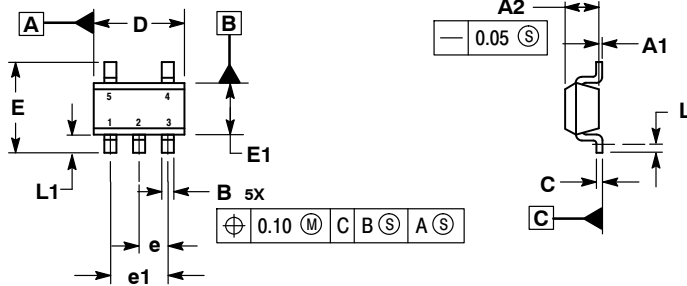

NOTES:

1. DIMENSIONS ARE IN MILLIMETERS.
2. INTERPRET DIMENSIONS AND TOLERANCES PER ASME Y14.5M, 1994.
3. DATUM C IS A SEATING PLANE.

DIM	MILLIMETERS	
	MIN	MAX
A1	0.00	0.10
A2	1.00	1.30
B	0.30	0.50
C	0.10	0.25
D	2.80	3.00
E	2.50	3.10
E1	1.50	1.80
e	0.95 BSC	
e1	1.90 BSC	
L	0.20	---
L1	0.45	0.75

ON Semiconductor and are registered trademarks of Semiconductor Components Industries, LLC (SCILLC). SCILLC reserves the right to make changes without further notice to any products herein. SCILLC makes no warranty, representation or guarantee regarding the suitability of its products for any particular purpose, nor does SCILLC assume any liability arising out of the application or use of any product or circuit, and specifically disclaims any and all liability, including without limitation special, consequential or incidental damages. "Typical" parameters which may be provided in SCILLC data sheets and/or specifications can and do vary in different applications and actual performance may vary over time. All operating parameters, including "Typicals" must be validated for each customer application by customer's technical experts. SCILLC does not convey any license under its patent rights nor the rights of others. SCILLC products are not designed, intended, or authorized for use as components in systems intended for surgical implant into the body, or other applications intended to support or sustain life, or for any other application in which the failure of the SCILLC product could create a situation where personal injury or death may occur. Should Buyer purchase or use SCILLC products for any such unintended or unauthorized application, Buyer shall indemnify and hold SCILLC and its officers, employees, subsidiaries, affiliates, and distributors harmless against all claims, costs, damages, and expenses, and reasonable attorney fees arising out of, directly or indirectly, any claim of personal injury or death associated with such unintended or unauthorized use, even if such claim alleges that SCILLC was negligent regarding the design or manufacture of the part. SCILLC is an Equal Opportunity/Affirmative Action Employer. This literature is subject to all applicable copyright laws and is not for resale in any manner.

### PUBLICATION ORDERING INFORMATION

**LITERATURE FULFILLMENT:**  
Literature Distribution Center for ON Semiconductor  
P.O. Box 5163, Denver, Colorado 80217 USA  
**Phone:** 303-675-2175 or 800-344-3860 Toll Free USA/Canada  
**Fax:** 303-675-2176 or 800-344-3867 Toll Free USA/Canada  
**Email:** orderlit@onsemi.com

**N. American Technical Support:** 800-282-9855 Toll Free  
USA/Canada  
**Europe, Middle East and Africa Technical Support:**  
Phone: 421 33 790 2910  
**Japan Customer Focus Center**  
Phone: 81-3-5773-3850

**ON Semiconductor Website:** [www.onsemi.com](http://www.onsemi.com)  
**Order Literature:** <http://www.onsemi.com/orderlit>  
For additional information, please contact your local Sales Representative