

# MMBT5401LT1G, SMMBT5401LT1G, MMBT5401LT3G



ON Semiconductor®

<http://onsemi.com>

## High Voltage Transistor

PNP Silicon

### Features

- AEC-Q101 Qualified and PPAP Capable
- S Prefix for Automotive and Other Applications Requiring Unique Site and Control Change Requirements
- These Devices are Pb-Free, Halogen Free/BFR Free and are RoHS Compliant

### MAXIMUM RATINGS

Rating	Symbol	Value	Unit
Collector - Emitter Voltage	$V_{CEO}$	-150	Vdc
Collector - Base Voltage	$V_{CBO}$	-160	Vdc
Emitter - Base Voltage	$V_{EBO}$	-5.0	Vdc
Collector Current - Continuous	$I_C$	-500	mAdc

Stresses exceeding Maximum Ratings may damage the device. Maximum Ratings are stress ratings only. Functional operation above the Recommended Operating Conditions is not implied. Extended exposure to stresses above the Recommended Operating Conditions may affect device reliability.

### THERMAL CHARACTERISTICS

Characteristic	Symbol	Max	Unit
Total Device Dissipation FR-5 Board (Note 1) $T_A = 25^\circ\text{C}$ Derate Above $25^\circ\text{C}$	$P_D$	225	mW
Thermal Resistance, Junction-to-Ambient	$R_{\theta JA}$	556	$^\circ\text{C}/\text{W}$
Total Device Dissipation Alumina Substrate (Note 2) $T_A = 25^\circ\text{C}$ Derate Above $25^\circ\text{C}$	$P_D$	300	mW
Thermal Resistance, Junction-to-Ambient	$R_{\theta JA}$	417	$^\circ\text{C}/\text{W}$
Junction and Storage Temperature	$T_J, T_{stg}$	-55 to +150	$^\circ\text{C}$

1. FR-5 =  $1.0 \times 0.75 \times 0.062$  in.
2. Alumina =  $0.4 \times 0.3 \times 0.024$  in 99.5% alumina.

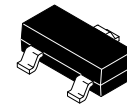

SOT-23 (TO-236)  
CASE 318  
STYLE 6

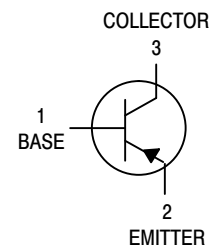

### MARKING DIAGRAM

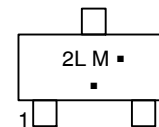

2L = Specific Device Code  
M = Date Code\*  
▪ = Pb-Free Package

(Note: Microdot may be in either location)

\*Date Code orientation and/or overbar may vary depending upon manufacturing location.

### ORDERING INFORMATION

Device	Package	Shipping†
MMBT5401LT1G	SOT-23 (Pb-Free)	3,000 Tape & Reel
SMMBT5401LT1G	SOT-23 (Pb-Free)	3,000 Tape & Reel
MMBT5401LT3G	SOT-23 (Pb-Free)	10,000 Tape & Reel

†For information on tape and reel specifications, including part orientation and tape sizes, please refer to our Tape and Reel Packaging Specifications Brochure, BRD8011/D.

# MMBT5401LT1G, SMMBT5401LT1G, MMBT5401LT3G

## ELECTRICAL CHARACTERISTICS (T<sub>A</sub> = 25°C unless otherwise noted)

Characteristic	Symbol	Min	Max	Unit
----------------	--------	-----	-----	------

### OFF CHARACTERISTICS

Collector–Emitter Breakdown Voltage (I <sub>C</sub> = -1.0 mA <sub>dc</sub> , I <sub>B</sub> = 0)	V <sub>(BR)CEO</sub>	-150	–	V <sub>dc</sub>
Collector–Base Breakdown Voltage (I <sub>C</sub> = -100 μA <sub>dc</sub> , I <sub>E</sub> = 0)	V <sub>(BR)CBO</sub>	-160	–	V <sub>dc</sub>
Emitter–Base Breakdown Voltage (I <sub>E</sub> = -10 μA <sub>dc</sub> , I <sub>C</sub> = 0)	V <sub>(BR)EBO</sub>	-5.0	–	V <sub>dc</sub>
Collector–Base Cutoff Current (V <sub>CB</sub> = -120 V <sub>dc</sub> , I <sub>E</sub> = 0) (V <sub>CB</sub> = -120 V <sub>dc</sub> , I <sub>E</sub> = 0, T <sub>A</sub> = 100°C)	I <sub>CBO</sub>	–	-50	nA <sub>dc</sub> μA <sub>dc</sub>

### ON CHARACTERISTICS

DC Current Gain (I <sub>C</sub> = -1.0 mA <sub>dc</sub> , V <sub>CE</sub> = -5.0 V <sub>dc</sub> ) (I <sub>C</sub> = -10 mA <sub>dc</sub> , V <sub>CE</sub> = -5.0 V <sub>dc</sub> ) (I <sub>C</sub> = -50 mA <sub>dc</sub> , V <sub>CE</sub> = -5.0 V <sub>dc</sub> )	h <sub>FE</sub>	50 60 50	– 240 –	–
Collector–Emitter Saturation Voltage (I <sub>C</sub> = -10 mA <sub>dc</sub> , I <sub>B</sub> = -1.0 mA <sub>dc</sub> ) (I <sub>C</sub> = -50 mA <sub>dc</sub> , I <sub>B</sub> = -5.0 mA <sub>dc</sub> )	V <sub>CE(sat)</sub>	– –	-0.2 -0.5	V <sub>dc</sub>
Base–Emitter Saturation Voltage (I <sub>C</sub> = -10 mA <sub>dc</sub> , I <sub>B</sub> = -1.0 mA <sub>dc</sub> ) (I <sub>C</sub> = -50 mA <sub>dc</sub> , I <sub>B</sub> = -5.0 mA <sub>dc</sub> )	V <sub>BE(sat)</sub>	– –	-1.0 -1.0	V <sub>dc</sub>

### SMALL-SIGNAL CHARACTERISTICS

Current–Gain — Bandwidth Product (I <sub>C</sub> = -10 mA <sub>dc</sub> , V <sub>CE</sub> = -10 V <sub>dc</sub> , f = 100 MHz)	f <sub>T</sub>	100	300	MHz
Output Capacitance (V <sub>CB</sub> = -10 V <sub>dc</sub> , I <sub>E</sub> = 0, f = 1.0 MHz)	C <sub>obo</sub>	–	6.0	pF
Small Signal Current Gain (I <sub>C</sub> = -1.0 mA <sub>dc</sub> , V <sub>CE</sub> = -10 V <sub>dc</sub> , f = 1.0 kHz)	h <sub>fe</sub>	40	200	–
Noise Figure (I <sub>C</sub> = -200 μA <sub>dc</sub> , V <sub>CE</sub> = -5.0 V <sub>dc</sub> , R <sub>S</sub> = 10 Ω, f = 1.0 kHz)	NF	–	8.0	dB

# MMBT5401LT1G, SMMBT5401LT1G, MMBT5401LT3G

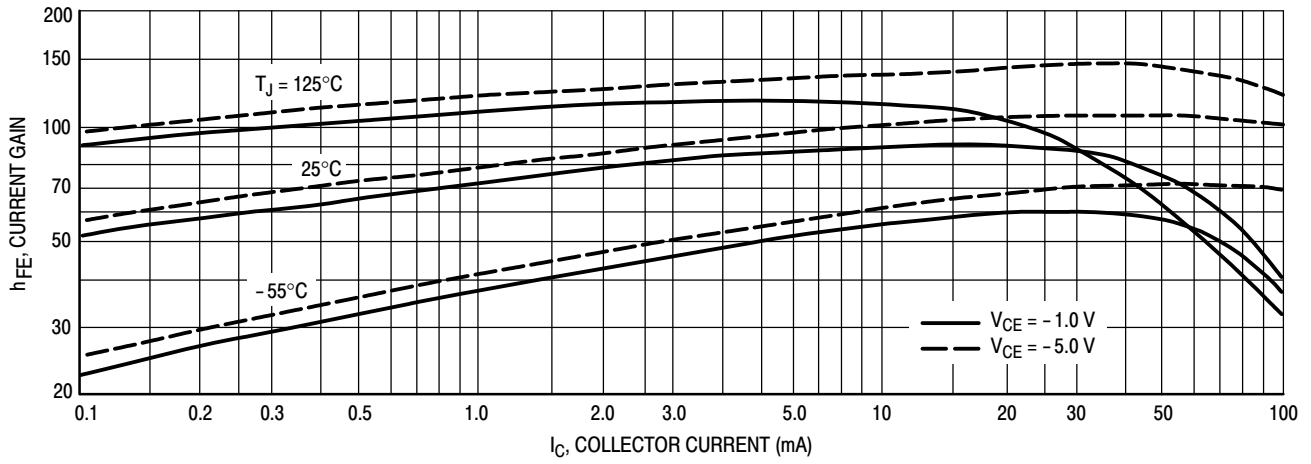

Figure 1. DC Current Gain

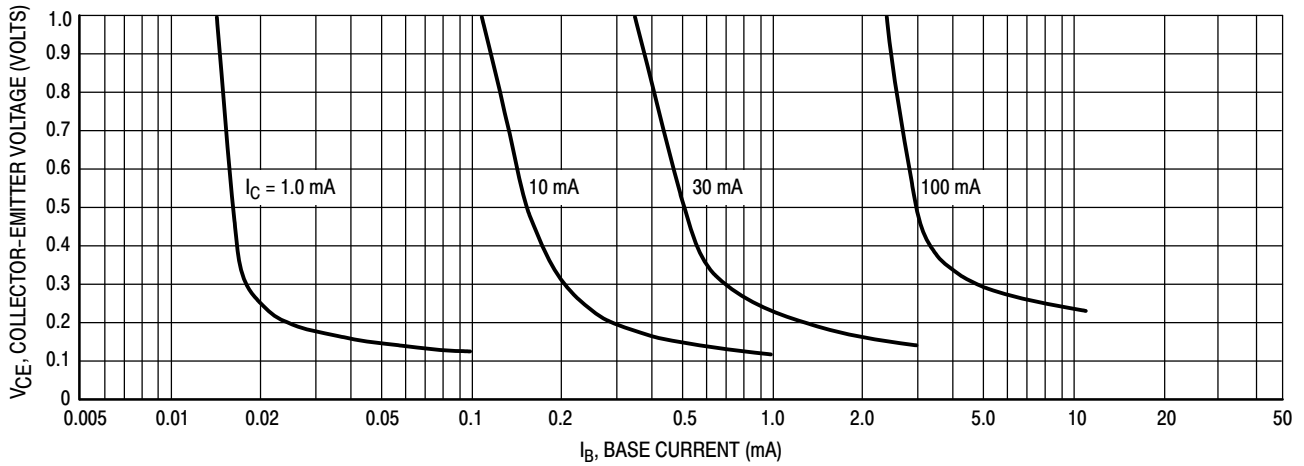

Figure 2. Collector Saturation Region

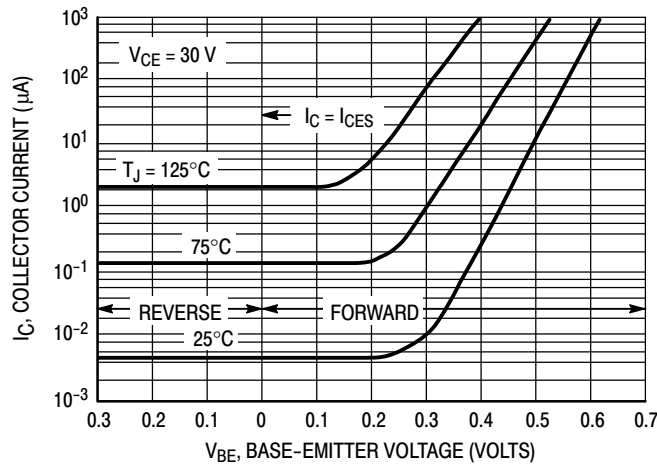

Figure 3. Collector Cut-Off Region

MMBT5401LT1G, SMMBT5401LT1G, MMBT5401LT3G

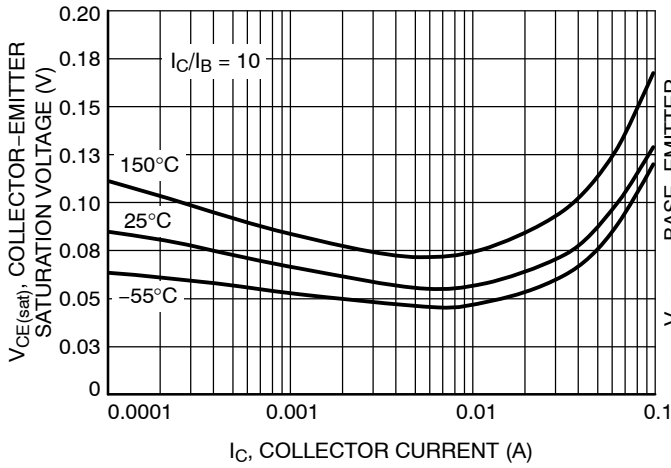

Figure 4. Collector Emitter Saturation Voltage vs. Collector Current

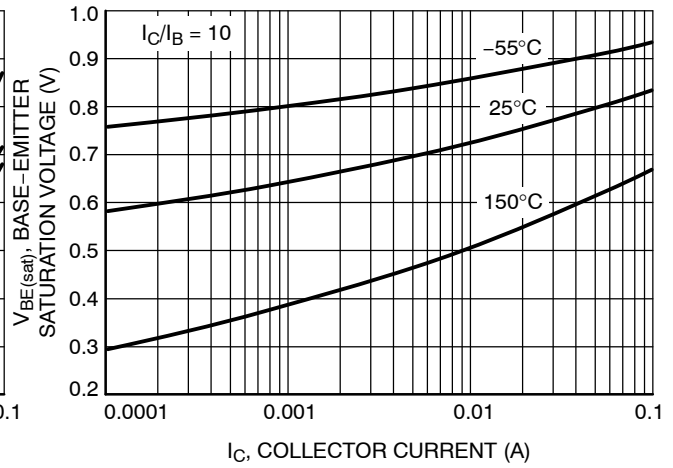

Figure 5. Base Emitter Saturation Voltage vs. Collector Current

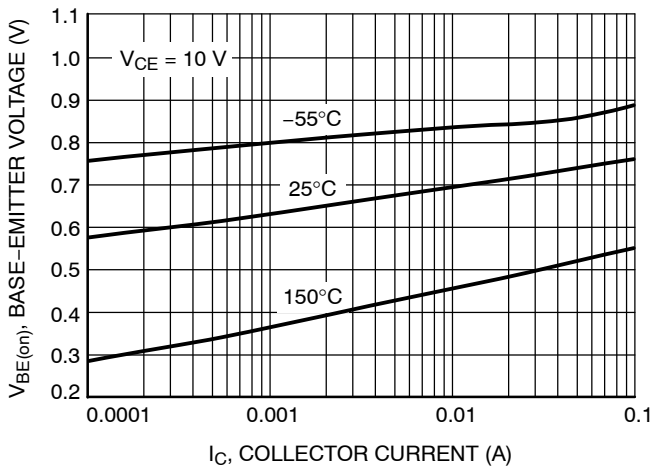

Figure 6. Base Emitter Voltage vs. Collector Current

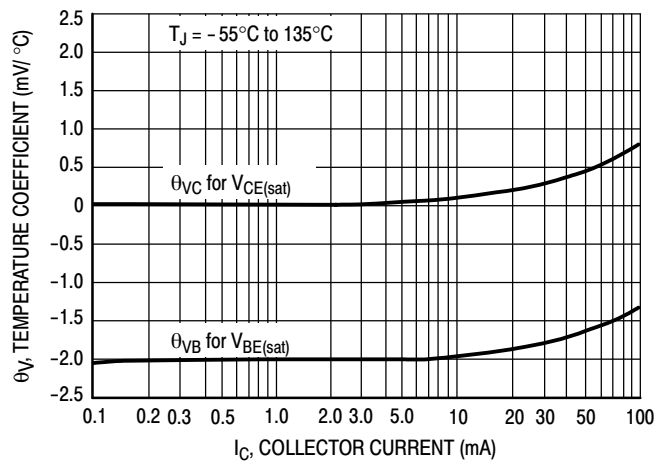

Figure 7. Temperature Coefficients

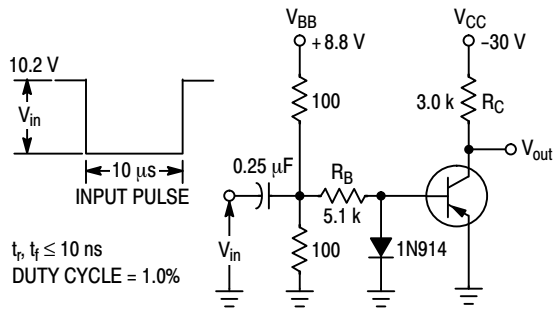

Figure 8. Switching Time Test Circuit

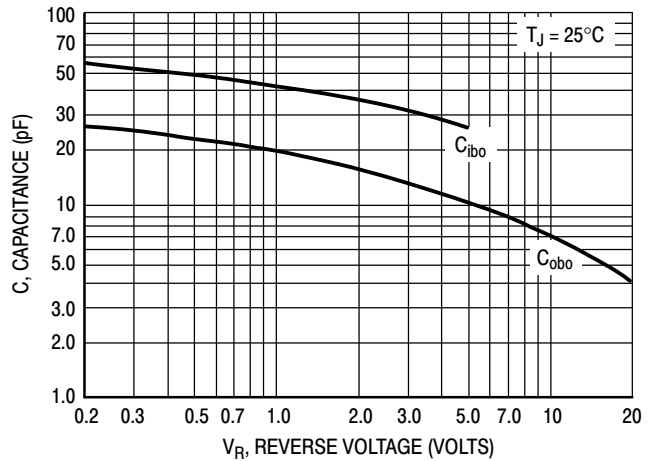

Figure 9. Capacitances

MMBT5401LT1G, SMMBT5401LT1G, MMBT5401LT3G

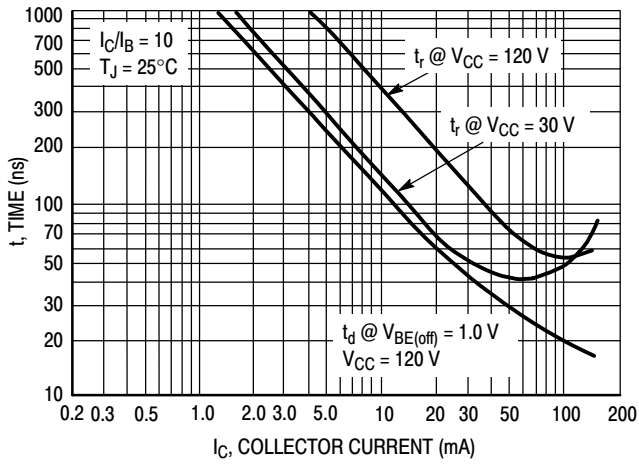

Figure 10. Turn-On Time

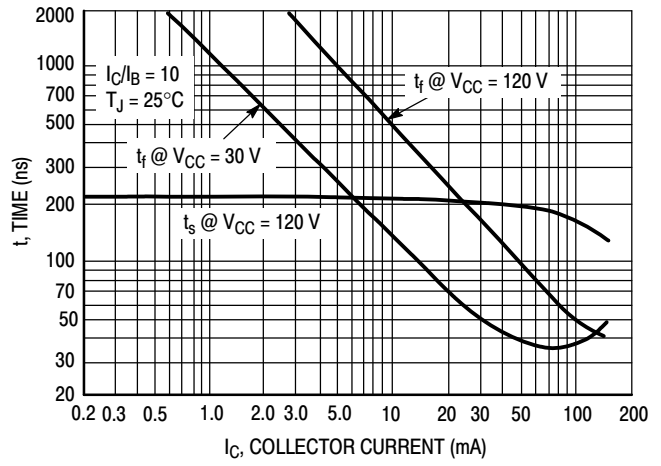

Figure 11. Turn-Off Time

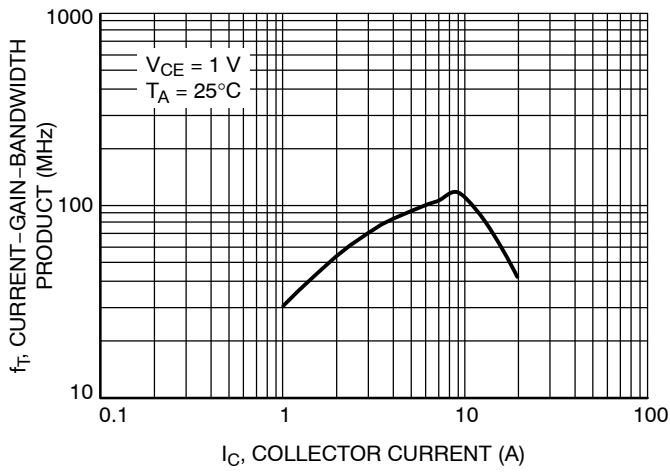

Figure 12. Current Gain Bandwidth Product

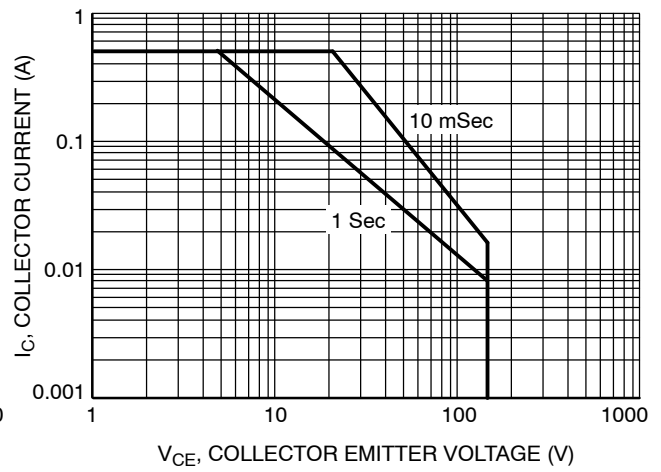
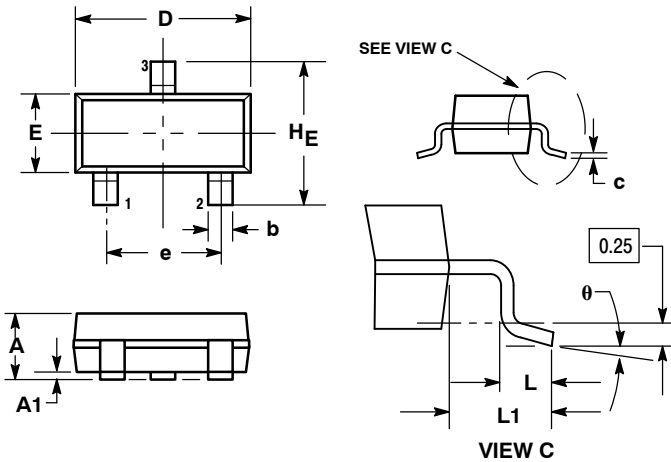

Figure 13. Safe Operating Area

# MMBT5401LT1G, SMMBT5401LT1G, MMBT5401LT3G

## PACKAGE DIMENSIONS

SOT-23 (TO-236)  
CASE 318-08  
ISSUE AP



NOTES:

1. DIMENSIONING AND TOLERANCING PER ANSI Y14.5M, 1982.
2. CONTROLLING DIMENSION: INCH.
3. MAXIMUM LEAD THICKNESS INCLUDES LEAD FINISH THICKNESS. MINIMUM LEAD THICKNESS IS THE MINIMUM THICKNESS OF BASE MATERIAL.
4. DIMENSIONS D AND E DO NOT INCLUDE MOLD FLASH, PROTRUSIONS, OR GATE BURRS.

DIM	MILLIMETERS			INCHES		
	MIN	NOM	MAX	MIN	NOM	MAX
A	0.89	1.00	1.11	0.035	0.040	0.044
A1	0.01	0.06	0.10	0.001	0.002	0.004
b	0.37	0.44	0.50	0.015	0.018	0.020
c	0.09	0.13	0.18	0.003	0.005	0.007
D	2.80	2.90	3.04	0.110	0.114	0.120
E	1.20	1.30	1.40	0.047	0.051	0.055
e	1.78	1.90	2.04	0.070	0.075	0.081
L	0.10	0.20	0.30	0.004	0.008	0.012
L1	0.35	0.54	0.69	0.014	0.021	0.029
HE	2.10	2.40	2.64	0.083	0.094	0.104
θ	0°	---	10°	0°	---	10°

STYLE 6:

- PIN 1. BASE
- EMITTER
- COLLECTOR

### SOLDERING FOOTPRINT

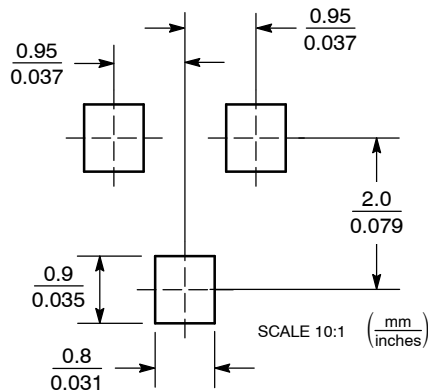

ON Semiconductor and are registered trademarks of Semiconductor Components Industries, LLC (SCILLC). SCILLC reserves the right to make changes without further notice to any products herein. SCILLC makes no warranty, representation or guarantee regarding the suitability of its products for any particular purpose, nor does SCILLC assume any liability arising out of the application or use of any product or circuit, and specifically disclaims any and all liability, including without limitation special, consequential or incidental damages. "Typical" parameters which may be provided in SCILLC data sheets and/or specifications can and do vary in different applications and actual performance may vary over time. All operating parameters, including "Typicals" must be validated for each customer application by customer's technical experts. SCILLC does not convey any license under its patent rights nor the rights of others. SCILLC products are not designed, intended, or authorized for use as components in systems intended for surgical implant into the body, or other applications intended to support or sustain life, or for any other application in which the failure of the SCILLC product could create a situation where personal injury or death may occur. Should Buyer purchase or use SCILLC products for any such unintended or unauthorized application, Buyer shall indemnify and hold SCILLC and its officers, employees, subsidiaries, affiliates, and distributors harmless against all claims, costs, damages, and expenses, and reasonable attorney fees arising out of, directly or indirectly, any claim of personal injury or death associated with such unintended or unauthorized use, even if such claim alleges that SCILLC was negligent regarding the design or manufacture of the part. SCILLC is an Equal Opportunity/Affirmative Action Employer. This literature is subject to all applicable copyright laws and is not for resale in any manner.

### PUBLICATION ORDERING INFORMATION

LITERATURE FULFILLMENT:

Literature Distribution Center for ON Semiconductor  
P.O. Box 5163, Denver, Colorado 80217 USA  
Phone: 303-675-2175 or 800-344-3860 Toll Free USA/Canada  
Fax: 303-675-2176 or 800-344-3867 Toll Free USA/Canada  
Email: orderlit@onsemi.com

N. American Technical Support: 800-282-9855 Toll Free  
USA/Canada  
Europe, Middle East and Africa Technical Support:  
Phone: 421 33 790 2910  
Japan Customer Focus Center  
Phone: 81-3-5817-1050

ON Semiconductor Website: [www.onsemi.com](http://www.onsemi.com)

Order Literature: <http://www.onsemi.com/orderlit>

For additional information, please contact your local Sales Representative