

## 80SQ... SERIES

### SCHOTTKY RECTIFIER

8 Amp

#### Major Ratings and Characteristics

Characteristics	80SQ...	Units
$I_{F(AV)}$ Rectangular waveform	8	A
$V_{RRM}$ range	35 to 45	V
$I_{FSM}$ @ $t_p = 5 \mu s$ sine	2400	A
$V_F$ @ 8Apk, $T_J = 125^\circ C$	0.44	V
$T_J$ range	-55 to 175	$^\circ C$

#### Description/Features

The 80SQ axial leaded Schottky rectifier series has been optimized for low reverse leakage at high temperature. The proprietary barrier technology allows for reliable operation up to 175°C junction temperature. Typical applications are in switching power supplies, converters, free-wheeling diodes, and reverse battery protection.

- 175° C  $T_J$  operation
- High purity, high temperature epoxy encapsulation for enhanced mechanical strength and moisture resistance
- Low forward voltage drop
- High frequency operation
- Guard ring for enhanced ruggedness and long term reliability

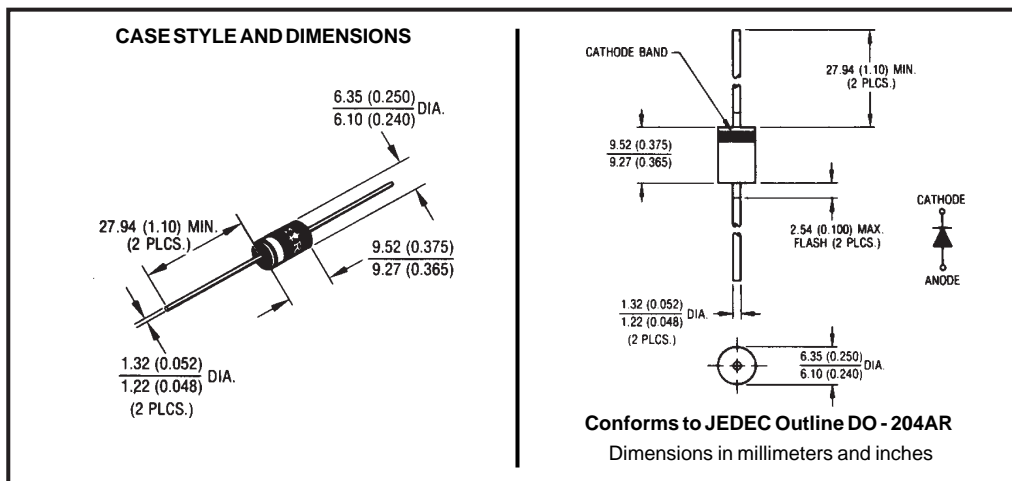

### Voltage Ratings

Part number	80SQ035	80SQ040	80SQ045
$V_R$ Max. DC Reverse Voltage (V)	35	40	45
$V_{RWM}$ Max. Working Peak Reverse Voltage (V)			

### Absolute Maximum Ratings

Parameters	80SQ	Units	Conditions
$I_{F(AV)}$ Max. Average Forward Current * See Fig. 5	8	A	50% duty cycle @ $T_C = 119^\circ\text{C}$ , rectangular wave form
$I_{FSM}$ Max. Peak One Cycle Non-Repetitive Surge Current * See Fig. 7	2400	A	Following any rated load condition and with rated $V_{RWM}$ applied
	380		
$E_{AS}$ Non-Repetitive Avalanche Energy	10	mJ	$T_J = 25^\circ\text{C}$ , $I_{AS} = 1.6$ Amps, $L = 7.8$ mH
$I_{AR}$ Repetitive Avalanche Current	1.6	A	Current decaying linearly to zero in 1 $\mu\text{sec}$ Frequency limited by $T_J$ max. $V_A = 1.5 \times V_R$ typical

### Electrical Specifications

Parameters	80SQ	Units	Conditions
$V_{FM}$ Max. Forward Voltage Drop (1) * See Fig. 1	0.53	V	@ 8A
	0.60	V	@ 16A
	0.44	V	@ 8A
	0.55	V	@ 16A
$I_{RM}$ Max. Reverse Leakage Current (1) * See Fig. 2	2	mA	$T_J = 25^\circ\text{C}$
	15	mA	$T_J = 125^\circ\text{C}$
$C_T$ Max. Junction Capacitance	900	pF	$V_R = 5V_{DC}$ , (test signal range 100Khz to 1Mhz) $25^\circ\text{C}$
$L_S$ Typical Series Inductance	10.0	nH	Measured lead to lead 5mm from body
dv/dt Max. Voltage Rate of Change (Rated $V_R$ )	10,000	V/ $\mu\text{s}$	

(1) Pulse Width < 300 $\mu\text{s}$ , Duty Cycle < 2%

### Thermal-Mechanical Specifications

Parameters	80SQ	Units	Conditions
$T_J$ Max. Junction Temperature Range	-55 to 175	$^\circ\text{C}$	
$T_{stg}$ Max. Storage Temperature Range	-55 to 175	$^\circ\text{C}$	
$R_{thJL}$ Max. Thermal Resistance Junction to Lead	8.0	$^\circ\text{C/W}$	DC operation * See Fig. 4 1/8 inch lead length
$R_{thJA}$ Typical Thermal Resistance, Junction to Air	44	$^\circ\text{C/W}$	
wt Approximate Weight	1.4(0.049)	g(oz.)	
Case Style	DO - 204AR		JEDEC

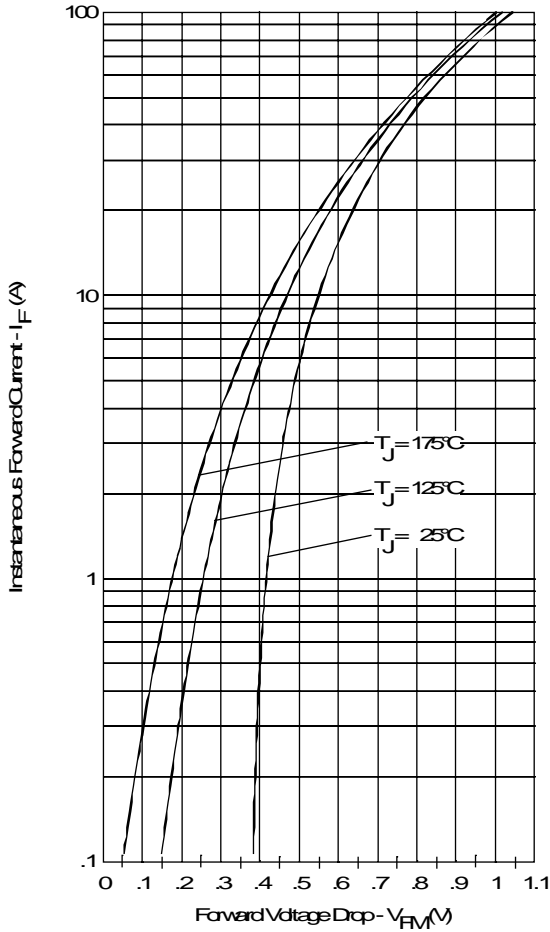

Fig. 1 - Maximum Forward Voltage Drop Characteristics

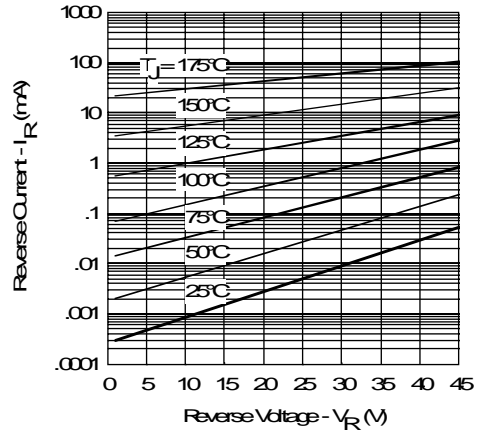

Fig. 2 - Typical Values of Reverse Current Vs. Reverse Voltage

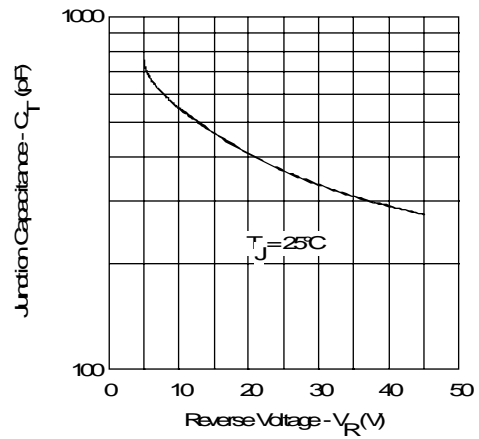

Fig. 3 - Typical Junction Capacitance Vs. Reverse Voltage

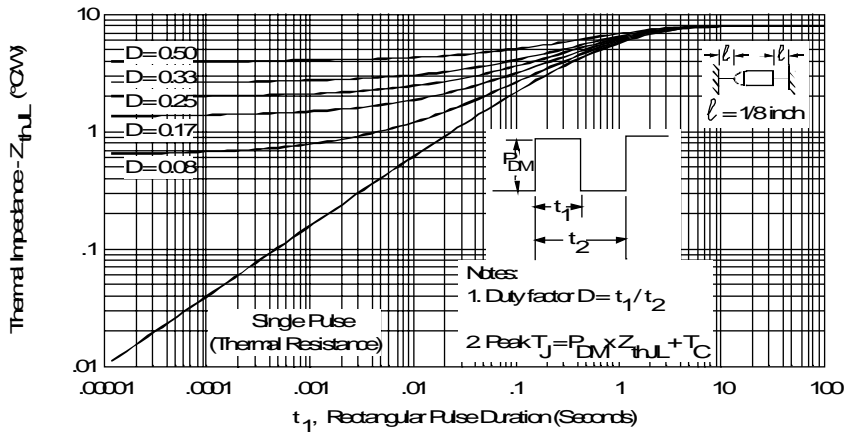

Fig. 4 - Maximum Thermal Impedance  $Z_{thJL}$  Characteristics

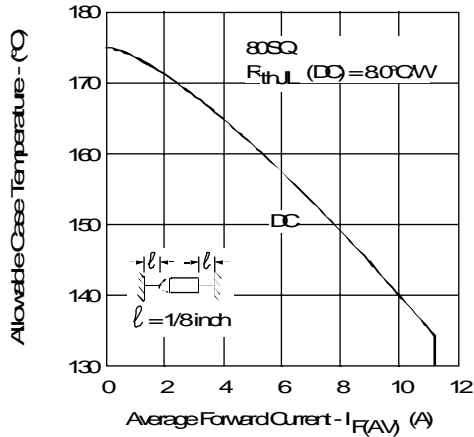

Fig. 5 - Maximum Allowable Case Temperature Vs. Average Forward Current

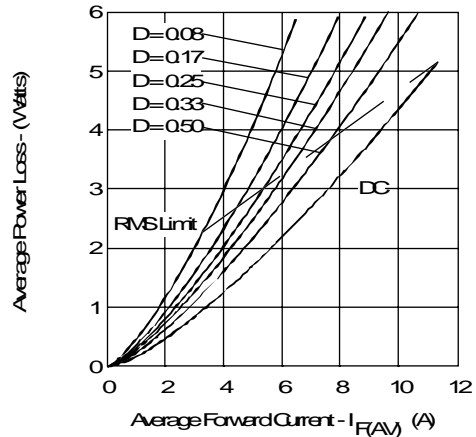

Fig. 6 - Forward Power Loss Characteristics

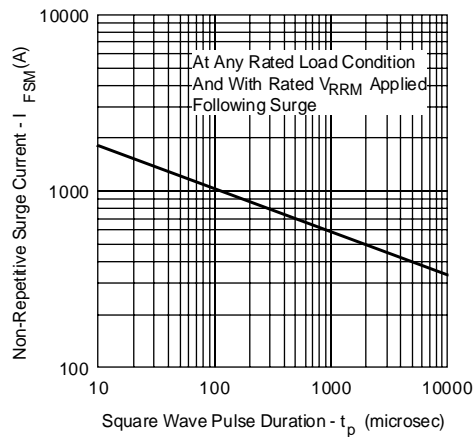

Fig. 7 - Maximum Non-Repetitive Surge Current

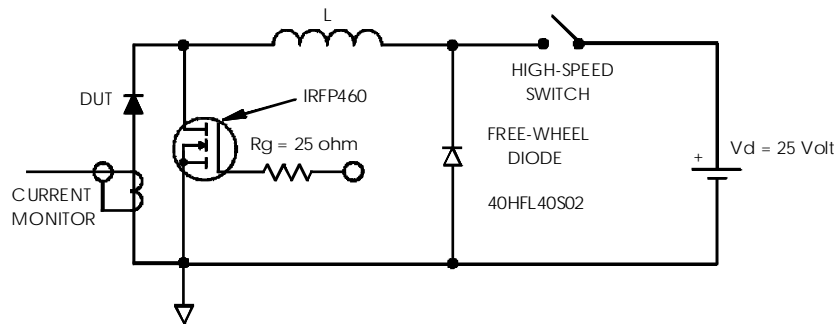

Fig. 8 - Unclamped Inductive Test Circuit