

PREPARED BY : DATE

APPROVED BY : DATE

SHARP

TENRI LIQUID CRYSTAL DISPLAY GROUP
SHARP CORPORATION

SPECIFICATION

SPEC No. LD-9211

FILE No.

ISSUE : Feb .19 .1997

PAGE : 17 pages

APPLICABLE GROUP

Tenri Liquid Crystal Display
Group

DEVICE SPECIFICATION FOR
TFT-LCD Module

MODEL No.

LQ10D34G

CUSTOMER'S APROVAL

DATE _____

BY _____

PRESENTED

BY 

H. FUKUOKA

Department General Manager

Engineering Department 2

TFT LCD Development Center

TENRI LIQUID CRYSTAL DISPLAY GROUP

SHARP CORPORATION

1. Application

This specification applies to color TFT-LCD module, LQ10D34G.

2. Overview

This module is a color active matrix LCD module incorporating amorphous silicon TFT (Thin Film Transistor). It is composed of a color TFT-LCD panel, driver ICs, control circuit and power supply circuit. Graphics and texts can be displayed on a $640 \times 3 \times 480$ dots panel with 262,144 colors by supplying 18 bit data signal (6bit/color), four kind of timing signals, +5V DC supply voltage for TFT-LCD panel driving.

The TFT-LCD panel used for this module is a low-reflection and higher-color-saturation type. Therefore, this module is also suitable for the multimedia use.

Backlight is not contained in this module.

3. Mechanical Specifications

Parameter	Specifications	Unit
Display size	26 (10.4") Diagonal	cm
Active area	211.2(H)×158.4(V)	mm
Pixel format	640(H)×480(V)	pixel
	(1 pixel=R+G+B dots)	
Pixel pitch	0.330(H)×0.330(V)	mm
Pixel configuration	R,G,B vertical stripe	
Display mode	Normally white	
Unit outline dimensions	265.0(W)×195.0(H)×8.0(D)	mm
Mass	420(+10, -20)	g
Surface treatment	Anti-glare and hard-coating 2H Haze value = $25 \pm 5\%$	

Outline dimensions is shown in Fig.1

4. Input Terminals

TFT-LCD panel driving

CN1 Used connector:DF9BA-31P-1V(59) (Gilding type: Hirose Electric Co., Ltd.)

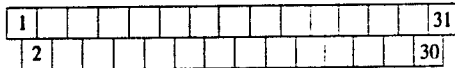

Corresponding connector: DF9 -31S-1V (59) (")

DF9A-31S-1V(59) (")

DF9B-31S-1V(59) (")

CN1 pin arrangement from module A side
(Transparent view)

Pin No.	Symbol	Function	Remark
1	GND		
2	CK	Clock signal for sampling each data signal	
3	Hsync	Horizontal synchronous signal	【Note1】
4	Vsync	Vertical synchronous signal	【Note1】
5	GND		
6	R0	R E D data signal(LSB)	
7	R1	R E D data signal	
8	R2	R E D data signal	
9	R3	R E D data signal	
10	R4	R E D data signal	
11	R5	R E D data signal(MSB)	
12	GND		
13	G0	G R E E N data signal(LSB)	
14	G1	G R E E N data signal	
15	G2	G R E E N data signal	
16	G3	G R E E N data signal	
17	G4	G R E E N data signal	
18	G5	G R E E N data signal(MSB)	
19	GND		
20	B0	B L U E data signal(LSB)	
21	B1	B L U E data signal	
22	B2	B L U E data signal	
23	B3	B L U E data signal	
24	B4	B L U E data signal	
25	B5	B L U E data signal(MSB)	
26	GND		
27	ENAB	Signal to settle the horizontal display position	【Note2】
28	Vcc	+ 5.0V power supply	
29	Vcc	+ 5.0V power supply	
30	R/L	Horizontal display mode select signal	【Note3】
31	U/D	Vertical display mode select signal	【Note4】

※The shielding case is connected with GND.

【Note1】 480 line, 400 line or 350 line mode is selected by the polarity combination of the both synchronous signals.

Mode	480 lines	400 lines	350 lines
Hsync	negative	negative	positive
Vsync	negative	positive	negative

【Note2】 The horizontal display start timing is settled in accordance with a rising timing of ENAB signal. In case ENAB is fixed "Low", the horizontal start timing is determined as described in 7-2. Don't keep ENAB "High" during operation.

【Note 3】

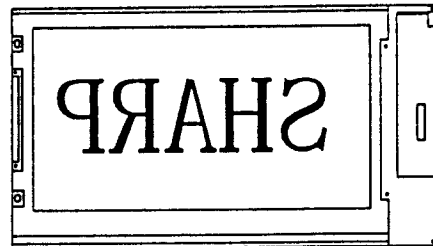
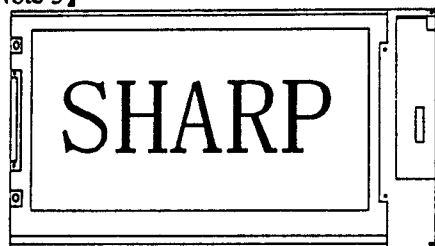

display reverse

R/L=Low , U/D=Low \longleftrightarrow R/L=High , U/D=Low

【Note 4】

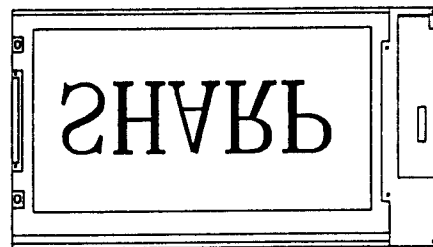
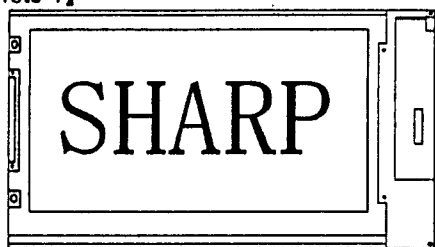

display reverse

R/L=Low , U/D=Low \longleftrightarrow R/L=Low , U/D=High

5. Absolute Maximum Ratings

Parameter	Symbol	Condition	Ratings	Unit	Remark
Input voltage	V_I	$T_a=25^\circ\text{C}$	$-0.3 \sim V_{CC}+0.3$	V	【Note1】
+5V supply voltage	V_{CC}	$T_a=25^\circ\text{C}$	$0 \sim +6$	V	
Storage temperature	T_{stg}	—	$-25 \sim +60$	$^\circ\text{C}$	【Note2】
Operating temperature (Ambient)	T_{opa}	—	$0 \sim +50$	$^\circ\text{C}$	
Light source wave length	λI	—	≥ 400	nm	
Light source illumination intensity	I_I	—	$\leq 300,000$	lx	【Note3】

【Note1】 CK,R0~R5,G0~G5,B0~B5,Hsync,Vsync,ENAB,TST1

【Note2】 Humidity : 95%RH Max. at $T_a \leq 40^\circ\text{C}$.Maximum wet-bulb temperature at 39°C or less at $T_a > 40^\circ\text{C}$.

No condensation.

The temperature of panel surface on side of backlight don't over 60°C by the self generation of heat.

【Note3】 Measurement point : panel surface (A side)

The light source used fluorescence lamp with three wave length.

6. Electrical Characteristics

6-1. TFT-LCD panel driving

Ta=25°C

Parameter		Symbol	Min.	Typ.	Max.	Unit	Remark
+5V	Supply voltage	V _{CC}	+4.5	+5.0	+5.5	V	【Note1】
	Current dissipation	I _{CC}	—	280	450	mA	【Note2】
Permissive input ripple voltage		V _{RP}	—	—	100	mV _{p-p}	V _{CC} =+5V
Input voltage (Low)		V _{IL}	—	—	0.3V _{CC}	V	【Note3】
Input voltage (High)		V _{IH}	0.7V _{CC}	—	—	V	
Input current (low)		I _{IL1}	—	—	1.0	μA	V _I =0V 【Note4】
		I _{IL2}	—	—	60.0	μA	V _I =0V 【Note5】
Input current (High)		I _{IH1}	—	—	1.0	μA	V _I =V _{CC} 【Note6】
		I _{IH2}	—	—	60.0	μA	V _I =V _{CC} 【Note7】

【Note1】

V_{CC}-turn-on conditions

$$t1 \leq 10\text{ms}$$

$$0 < t2 \leq 10\text{ms}$$

$$0 < t3 \leq 1\text{s}$$

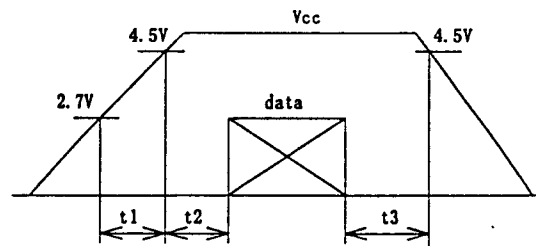
V_{CC}-dip conditions

$$1) 2.7\text{V} \leq V_{CC} < 4.5\text{V}$$

$$t_d \leq 10\text{ms}$$

$$2) V_{CC} < 2.7\text{V}$$

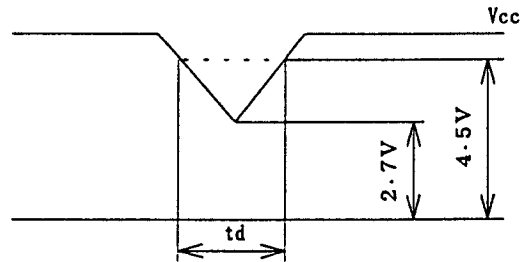
V_{CC}-dip conditions should also follow the V_{CC}-turn-on conditions

【Note2】 Typical current situation : 16-gray-bar pattern.

480 line mode

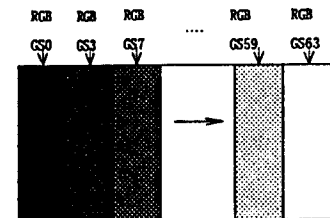
V_{CC}=+5.0V

【Note3】 CK,R0~R5,G0~G5,B0~B5,Hsync,Vsync,ENAB,R/L,U/D

【Note4】 CK,R0~R5,G0~G5,B0~B5,Hsync,Vsync,ENAB

【Note5】 R/L

【Note6】 CK,R0~R5,G0~G5,B0~B5,Hsync,Vsync

【Note7】 ENAB,U/D

7. Incidence light Source

Durable light intensity is different depending on incidence light direction, from side (A) or from side (B). Following is the specification for the incidence light from B.

Item	Symbol	Condition	Min.	Typ.	Max.	Unit	Remark	
incidence direction	B side	Y _{LB}	[Note 2]	-	-	6,500	cd/m ²	[Note 1]

As for light direction, A or B, refer to the Drawing Fig.-1.

【Note 1】 Incidence light shall be from B side.

【Note 2】 The measurement shall be executed after reaching max. brightness by aging.

The optical characteristics shall be measured in a dark room or equivalent state with the angle $\theta = 0^\circ$.

The light source used fluorescence lamp with three wave length.

※The intense light form A side is specified as a absolute maximum rating.

※In case of applying the light from A side, the panel surface brightness of outgoing light side (B side) shall be kept less than 6,500 cd/m².

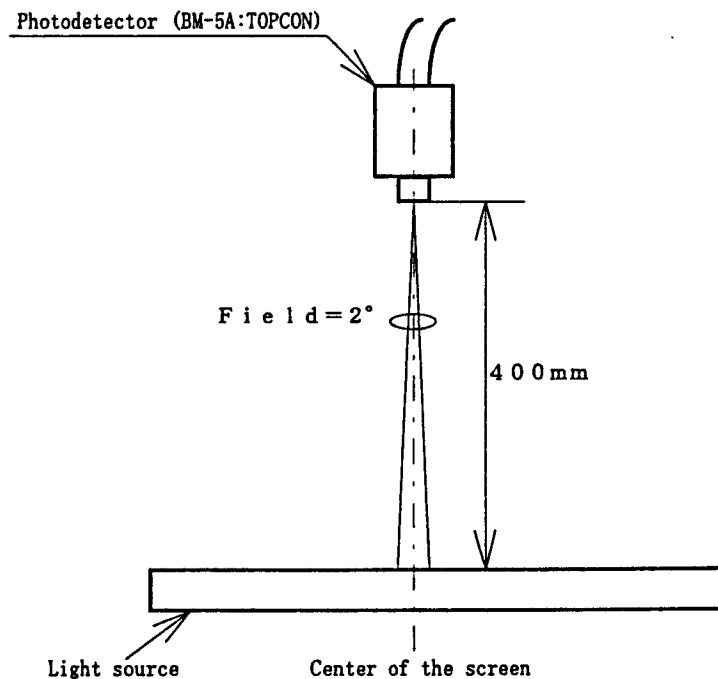

Fig. 5 Light source measurement method

8. Timing Characteristics of input signals

Timing diagrams of input signal are shown in Fig.2 - ①~③ .

8-1. Timing characteristics

Parameter		Symbol	Mode	Min.	Typ.	Max.	Unit	Remark
Clock	Frequency	1/Tc	all	—	25.18	28.33	MHz	
	High time	Tch	"	5	—	—	ns	
	Low time	Tcl	"	10	—	—	ns	
Data	Setup time	Tds	"	5	—	—	ns	
	Hold time	Tdh	"	10	—	—	ns	
Horizontal sync. signal	Cycle	TH	"	30.00	31.78	—	μ s	
			"	750	800	900	clock	
	Pulse width	THp	"	2	96	200	clock	
Vertical sync. signal	Cycle	TV	480	515	525	560	line	
			400	445	449	480	line	
			350	447	449	510	line	
	Pulse width	TVp	all	1	—	34	line	
Horizontal display period		THd	"	640	640	640	clock	
Hsync-Clock phase difference		THc	"	10	—	Tc-10	ns	
Hsync-Vsync phase difference		TVh	"	0	—	TH-THp	clock	

Note) In case of lower frequency, the deterioration of display quality, flicker etc., may be occurred.

8-2. Horizontal display position

The horizontal display position is determined by ENAB signal and the input data corresponding to the rising edge of ENAB signal is displayed at the left end of the active area.

Parameter		symbol	Min.	Typ.	Max.	Unit	Remark
Enable signal	Setup time	Tes	5	—	Tc-10	ns	
	Pulse width	Tep	2	640	640	clock	
Hsync-Enable signal phase difference		THE	44	—	164	clock	

Note) When ENAB is fixed "Low", the display starts from the data of C104(clock) as shown in Fig.2-①~③. Be careful that the module does not work when ENAB is fixed "High".

8-3. Vertical display position

The vertical display position is automatically centered in the active area at each mode of VGA, 480-, 400-, and 350-line mode. Each mode is selected depending on the polarity of the synchronous signals described in 4-1(Note1).

In each mode, the data of TVn is displayed at the top line of the active area. And the display position will be centered on the screen like the following figure when the period of vertical synchronous signal, TV, is typical value.

In 400-, and 350-line mode, the data in the vertical data invalid period is also displayed. So, inputting all data "0" is recommended during vertical data invalid period.

ENAB signal has no relation to the vertical display position.

mode	V-data start(TVs)	V-data period(TVd)	V-display start(TVn)	V-display period	Unit	Remark
480	34	480	34	480	line	
400	34	400	443-TV	480	line	
350	61	350	445-TV	480	line	

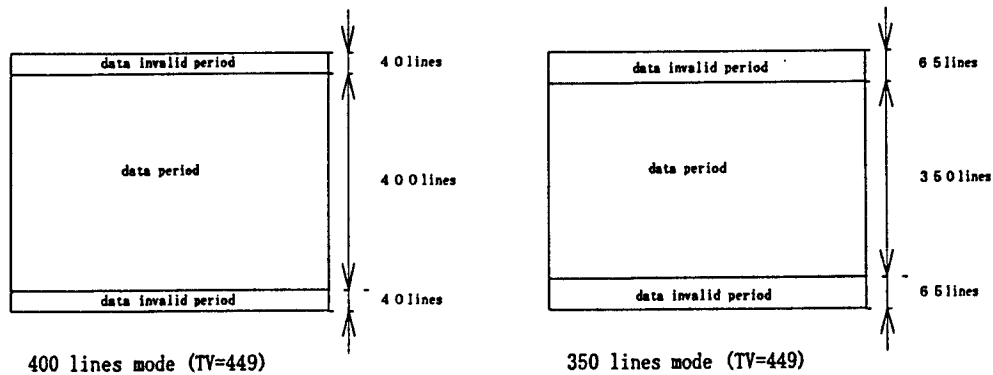

8-4. Input Data Signals and Display Position on the screen

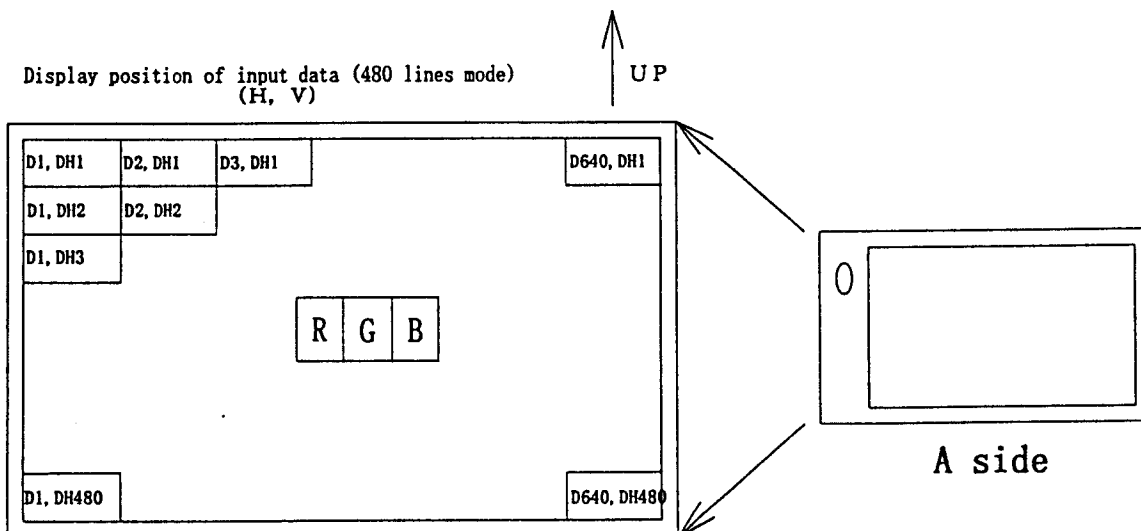

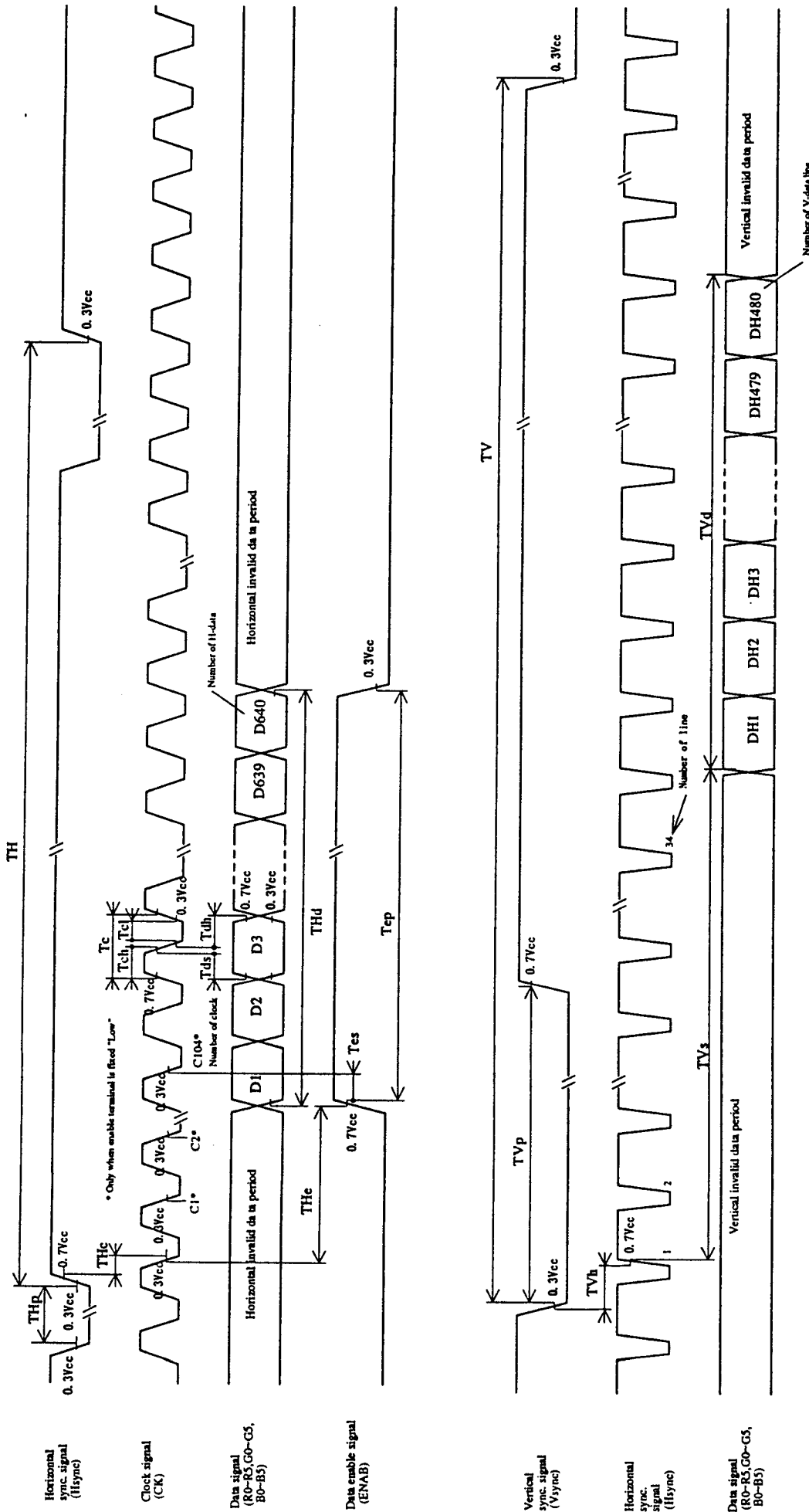

Fig 2-1 Input signal waveforms (480 line mode)

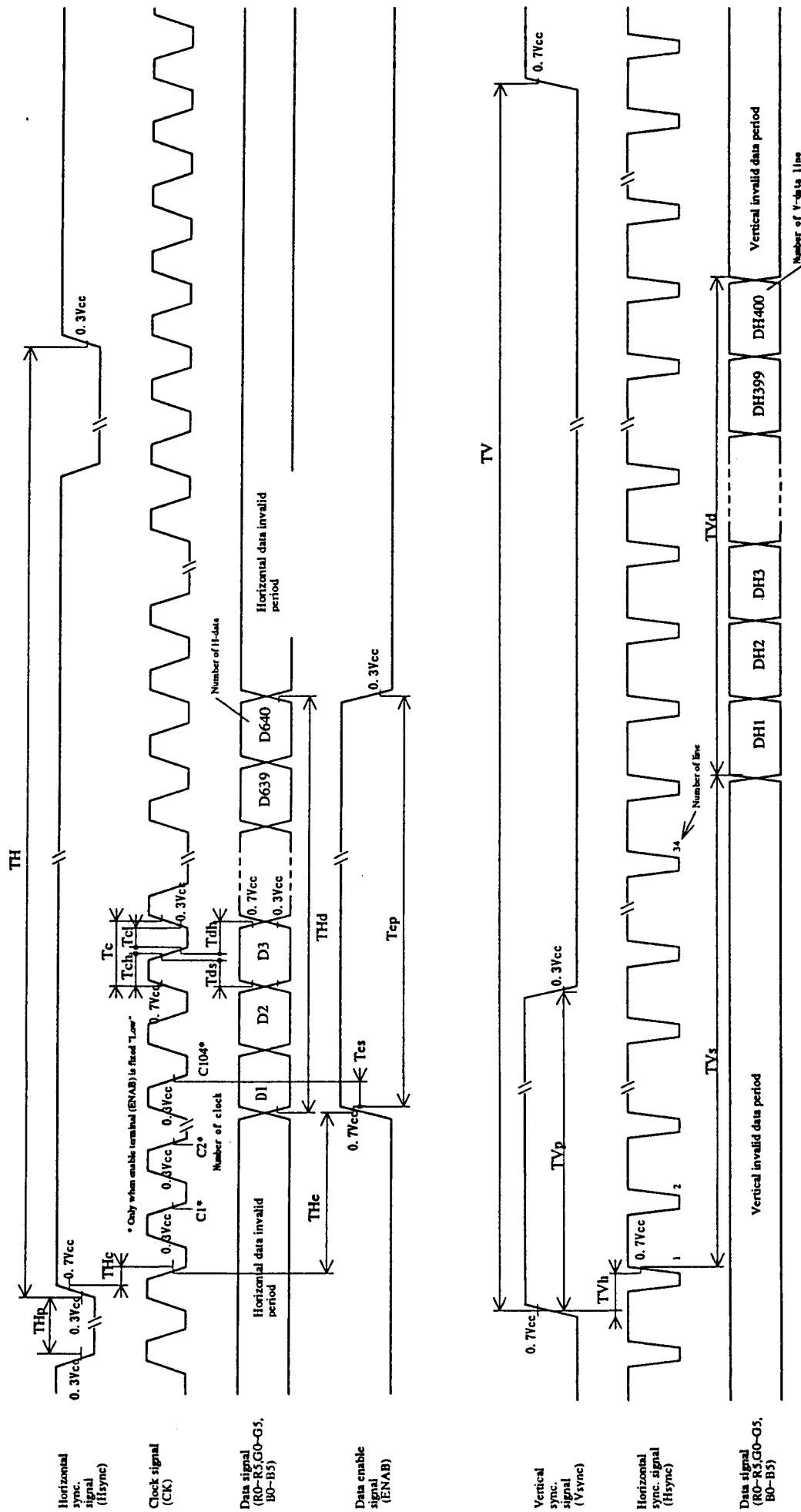

Fig.2-2 Input signal waveforms (400 line mode)

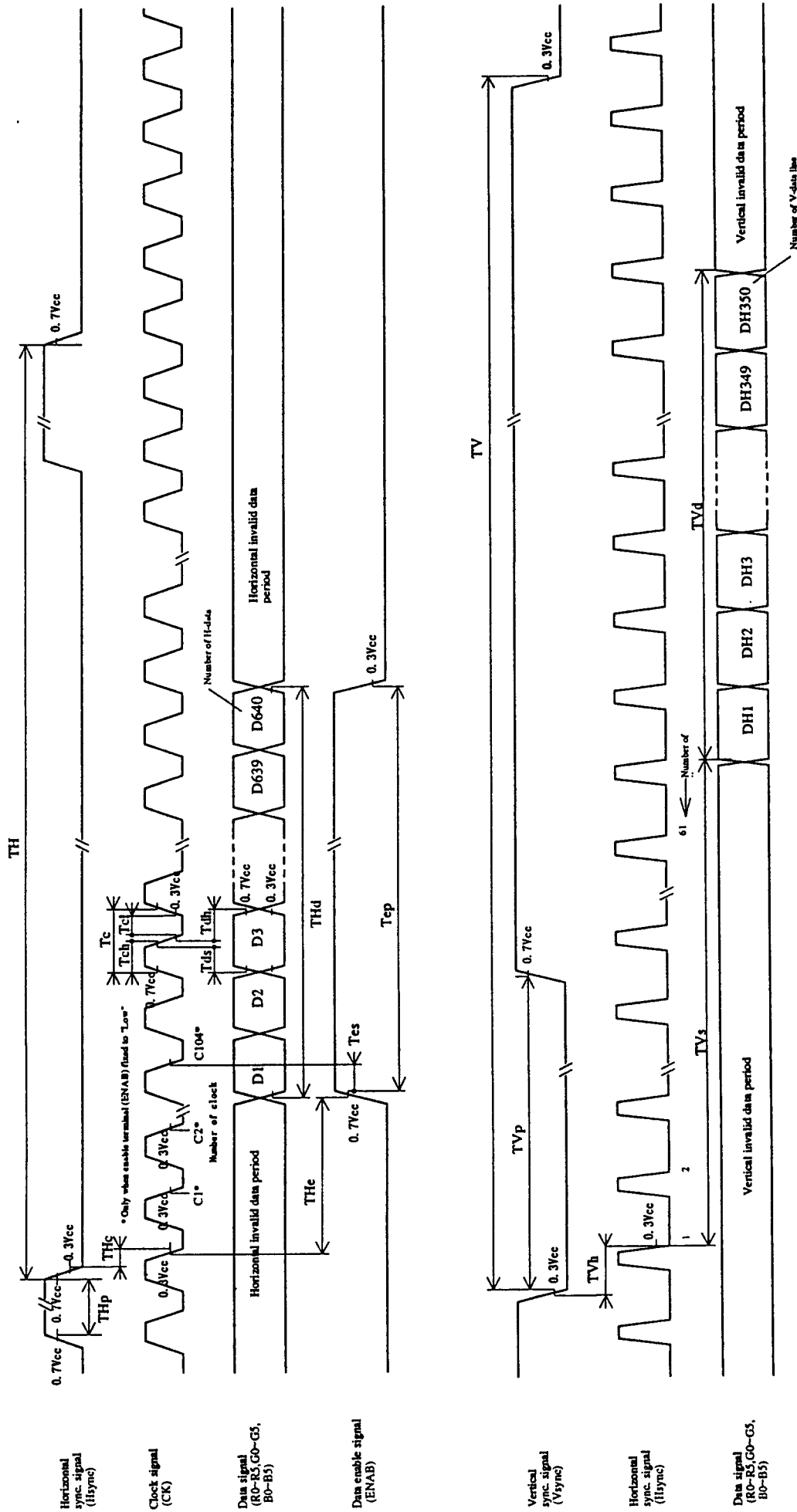

Fig.2-3 Input signal waveforms (350 line mode)

9. Input Signals, Basic Display Colors and Gray Scale of Each Color

	Colors & Gray scale	Data signal																		
		GrayScale	R0	R1	R2	R3	R4	R5	G0	G1	G2	G3	G4	G5	B0	B1	B2	B3	B4	B5
Basic color	Black	—	0	0	0	0	0	0	0	0	0	0	0	0	0	0	0	0	0	0
	Blue	—	0	0	0	0	0	0	0	0	0	0	0	0	1	1	1	1	1	1
	Green	—	0	0	0	0	0	0	1	1	1	1	1	1	0	0	0	0	0	0
	Cyan	—	0	0	0	0	0	0	1	1	1	1	1	1	1	1	1	1	1	1
	Red	—	1	1	1	1	1	1	0	0	0	0	0	0	0	0	0	0	0	0
	Magenta	—	1	1	1	1	1	1	0	0	0	0	0	0	1	1	1	1	1	1
	Yellow	—	1	1	1	1	1	1	1	1	1	1	1	1	0	0	0	0	0	0
	White	—	1	1	1	1	1	1	1	1	1	1	1	1	1	1	1	1	1	1
Gray Scale of red	Black	GS0	0	0	0	0	0	0	0	0	0	0	0	0	0	0	0	0	0	0
	↑	GS1	1	0	0	0	0	0	0	0	0	0	0	0	0	0	0	0	0	0
	Darker	GS2	0	1	0	0	0	0	0	0	0	0	0	0	0	0	0	0	0	0
	↑	↓				↓				↓				↓				↓		
	↓	↓				↓				↓				↓				↓		
	Brighter	GS61	1	0	1	1	1	1	0	0	0	0	0	0	0	0	0	0	0	0
	↓	GS62	0	1	1	1	1	1	0	0	0	0	0	0	0	0	0	0	0	0
	Red	GS63	1	1	1	1	1	1	0	0	0	0	0	0	0	0	0	0	0	0
Gray Scale of green	Black	GS0	0	0	0	0	0	0	0	0	0	0	0	0	0	0	0	0	0	0
	↑	GS1	0	0	0	0	0	0	1	0	0	0	0	0	0	0	0	0	0	0
	Darker	GS2	0	0	0	0	0	0	0	1	0	0	0	0	0	0	0	0	0	0
	↑	↓				↓				↓				↓				↓		
	↓	↓				↓				↓				↓				↓		
	Brighter	GS61	0	0	0	0	0	0	1	0	1	1	1	1	0	0	0	0	0	0
	↓	GS62	0	0	0	0	0	0	0	1	1	1	1	1	0	0	0	0	0	0
	Green	GS63	0	0	0	0	0	0	1	1	1	1	1	1	0	0	0	0	0	0
Gray Scale of blue	Black	GS0	0	0	0	0	0	0	0	0	0	0	0	0	0	0	0	0	0	0
	↑	GS1	0	0	0	0	0	0	0	0	0	0	0	0	1	0	0	0	0	0
	Darker	GS2	0	0	0	0	0	0	0	0	0	0	0	0	0	1	0	0	0	0
	↑	↓				↓				↓				↓				↓		
	↓	↓				↓				↓				↓				↓		
	Brighter	GS61	0	0	0	0	0	0	0	0	0	0	0	0	1	0	1	1	1	1
	↓	GS62	0	0	0	0	0	0	0	0	0	0	0	0	0	1	1	1	1	1
	Blue	GS63	0	0	0	0	0	0	0	0	0	0	0	0	1	1	1	1	1	1

0 : Low level voltage, 1 : High level voltage

Each basic color can be displayed in 64 gray scales from 6 bit data signals. According to the combination of total 18 bit data signals, the 262,144-color display can be achieved on the screen.

10. Optical Characteristics

Ta=25°C, Vcc=+5V

Parameter		Symbol	Condition	Min.	Typ.	Max.	Unit	Remark
Viewing angle range	Horizontal	$\theta 21, \theta 22$	CR>10	35	—	—	Deg.	【Note1,5】
	Vertical A (A side)	$\theta 11$		10	—	—	Deg.	incident light side
		$\theta 12$		30	—	—	Deg.	light side
	Vertical B (B side)	$\theta 11$		30	—	—	Deg.	incident light side
		$\theta 12$		10	—	—	Deg.	light side
Contrast ratio		CR	$\theta = 0^\circ$	100	—	—		【Note2,5】
Response time	Rise	τr		—	30	—	m s	【Note3,5】
	Decay	τd		—	50	—	m s	
Transmissivity		tr		6.2	7.3	—	%	【Note4,5】
Chromaticity shift		ΔX		-0.035	-0.005	+0.025		【Note5,6】
		ΔY	-0.010	+0.010	+0.050			

[Optical characteristics of backlight for measurement]

luminance : $\geq 3500\text{cd/m}^2$ wave length : $\geq 400\text{nm}$

※The measurement shall be executed 15~20 minutes after lighting at rating. The optical characteristics shall be measured in a dark room or equivalent state with the method show in Fig.3 below.

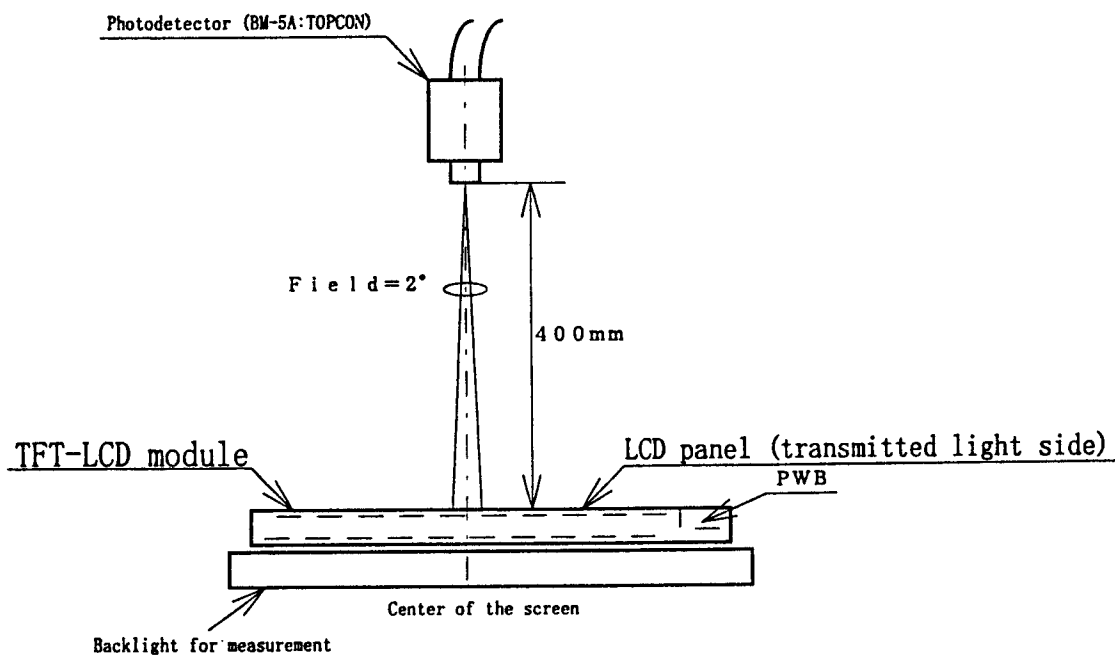
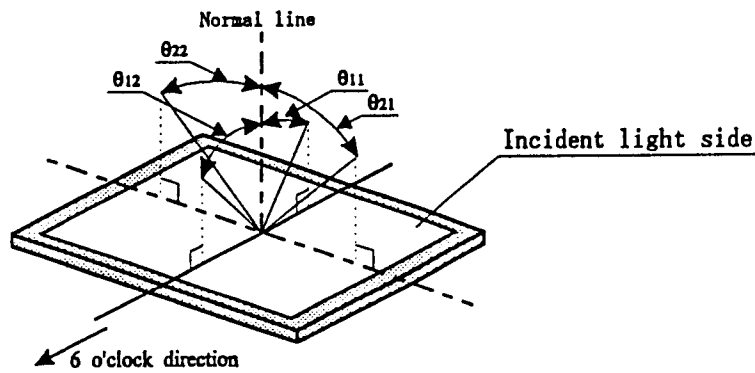

Fig.3 Optical characteristics measurement

【Note1】 Definitions of viewing angle range:



【Note2】 Definition of contrast ratio:

The contrast ratio is defined as the following.

$$\text{Contrast Ratio (CR)} = \frac{\text{Luminance (brightness) with all pixels white}}{\text{Luminance (brightness) with all pixels black}}$$

【Note3】 Definition of response time:

The response time is defined as the following figure and shall be measured by switching the input signal for "black" and "white".

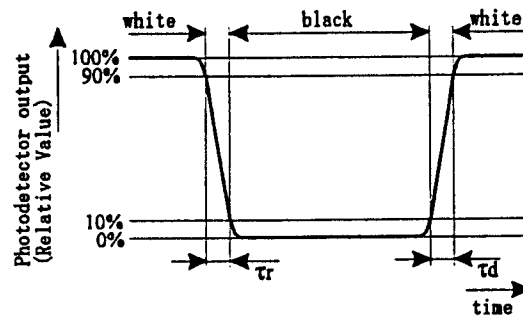

【Note4】 Definitions of Transmissivity:

$$\text{Transmissivity} = \frac{\text{light detected level of the transmission through the LCD panel}}{\text{light detected level of the original light source}}$$

【Note5】 The values are measured at center of the screen.

【Note6】 Chromaticity shift is the difference of those of the light source and the module placed on it.

The values are measured with standard illuminant : C(x=0.310, y=0.316)

11. Display Quantity

The display quality of the color TFT-LCD module shall be in compliance with the Incoming Inspection Standard.

12. Handling Precautions

- a) Be sure to turn off the power supply when inserting or disconnecting the cable.
- b) Be sure to design the cabinet so that the module can be installed without any extra stress such as warp or twist.
- c) Since the front polarizer is easily damaged, pay attention not to scratch it.
- d) Wipe off water drop immediately. Long contact with water may cause discoloration or spots.
- e) When the panel surface is soiled, wipe it with absorbent cotton or other soft cloth.
- f) Since the panel is made of glass, it may break or crack if dropped or bumped on hard surface. Handle with care.
- g) Since CMOS LSI is used in this module, take care of static electricity and injure the human earth when handling.
- h) Observe all other precautionary requirements in handling components.
- i) This module has its circuitry PCBs on the rear side and should be carefully handled in order not to be stressed.
- j) Laminated film is attached to the module surface to prevent it from being scratched . Peel the film off slowly , just before the use, with strict attention to electrostatic charges. Ionized air shall be blown over during the action. Blow off 'dust' on the polarizer by using an ionized nitrogen gun, etc.

13. Packing form

- a) Piling number of cartons : MAX.7
- b) Package quantity in one carton : 10pcs
- c) Carton size : 460(W)×300(H)×380(D)mm
- d) Total mass of 1 carton filled with full modules : 6150g

Packing form is shown in Fig.4

14. Reliability test items

No.	Test item	Conditions
1	High temperature storage test	Ta=60°C 240h
2	Low temperature storage test	Ta=-25°C 240h
3	High temperature & high humidity operation test	Ta=40°C ; 95%RH 240h (No condensation)
4	High temperature operation test	Ta=50°C 240h
5	Low temperature operation test	Ta=0°C 240h
6	Vibration test (non- operating)	Frequency : 10~57Hz/Vibration width (one side):0.075mm : 58~500Hz/Gravity:9.8m/s ² Sweep time : 11 minutes Test period : 3 hours (1 hour for each direction of X,Y,Z)
7	Shock test (non- operating)	Max. gravity : 490m/s ² Pulse width : 11ms, half sine wave Direction : ±X, ±Y, ±Z once for each direction.

【Result Evaluation Criteria】

Under the display quality test conditions with normal operation state, these shall be no change which may affect practical display function.

15. Others

1) Lot No. Label:

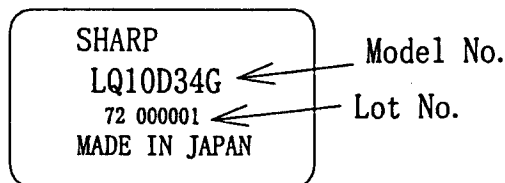

2) Adjusting volume have been set optimally before shipment, so do not change any adjusted value.

If adjusted value is changed, the specification may not be satisfied.

3) Disassembling the module can cause permanent damage and should be strictly avoided.

4) Please be careful since image retention may occur when a fixed pattern is displayed for a long time

5) If any problem occurs in relation to the description of this specification , it shall be resolved through discussion with spirit of cooperation.

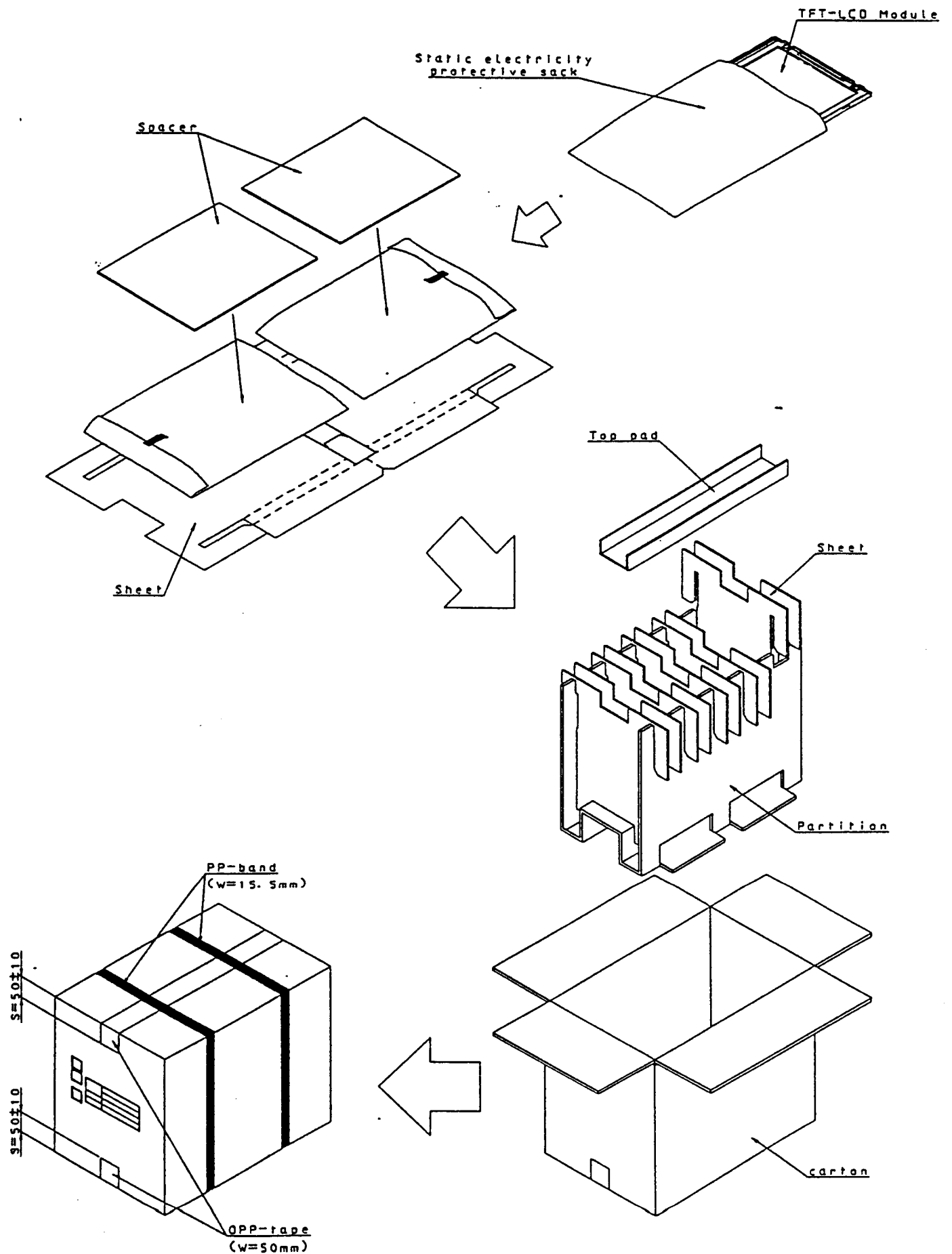
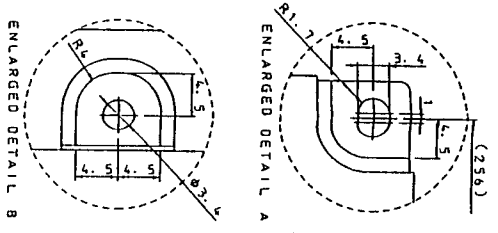
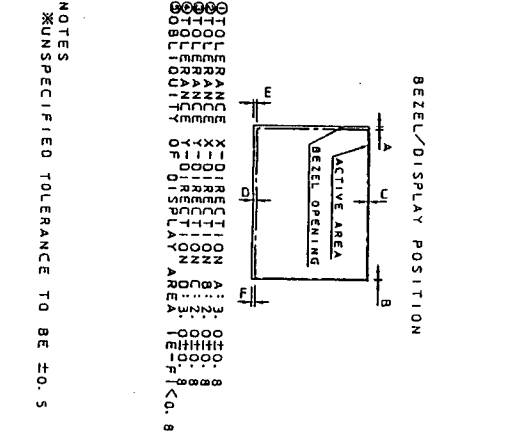
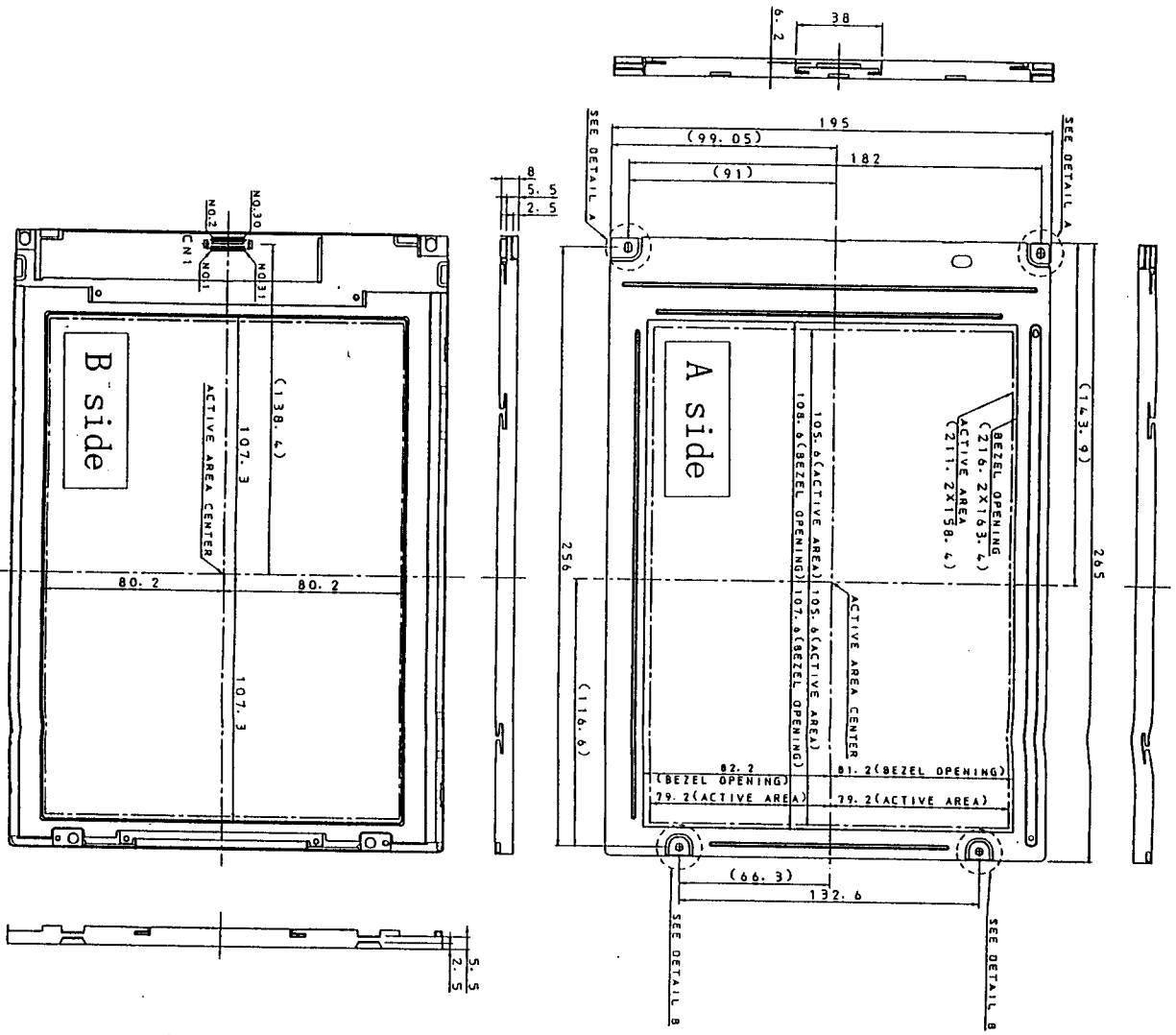

Fig.4 Packing form

Fig 1 LQ10D34G OUTLINE DIMENSIONS



12A

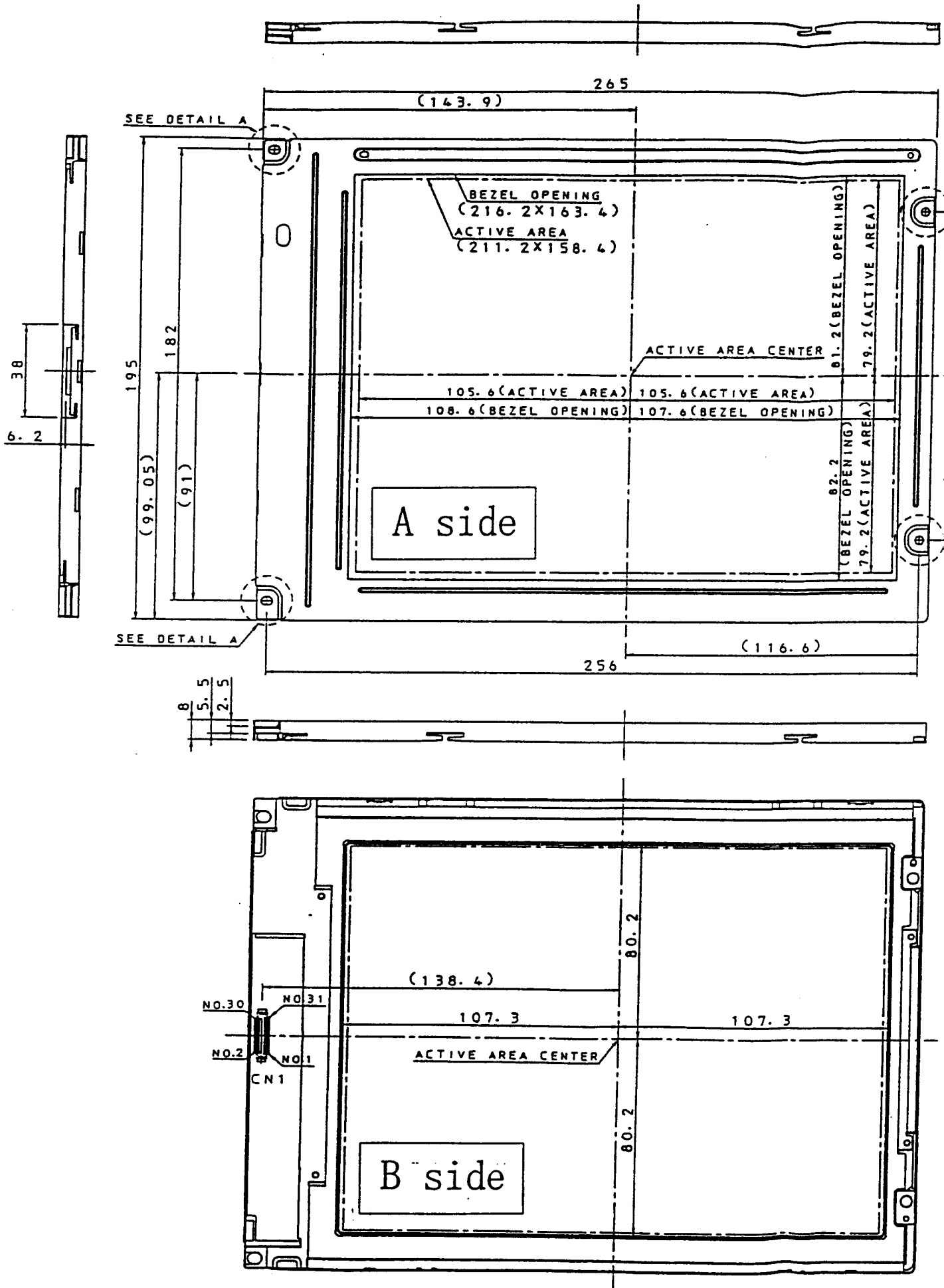
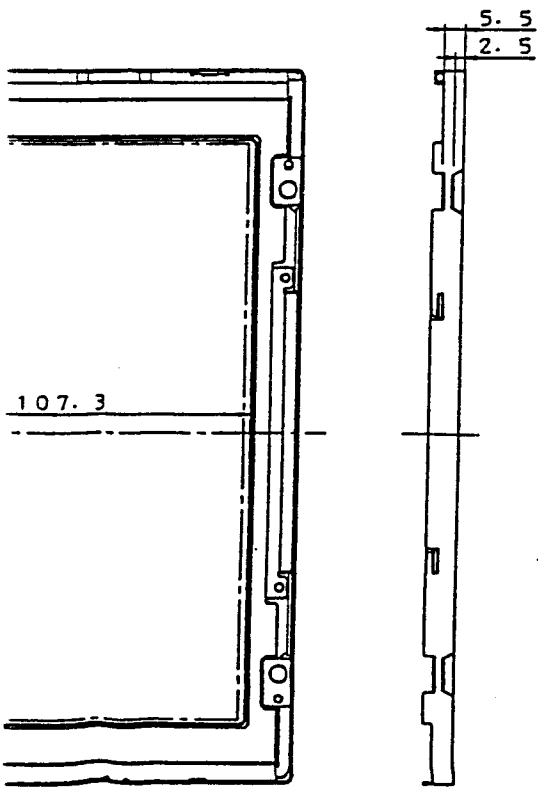
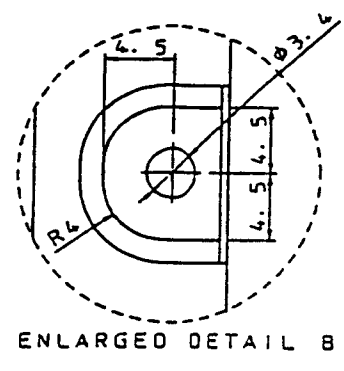
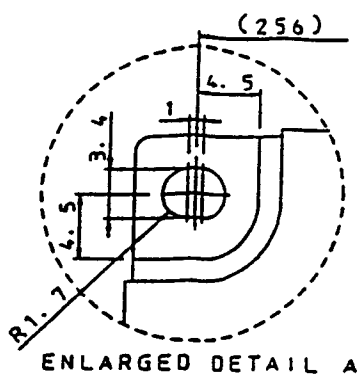
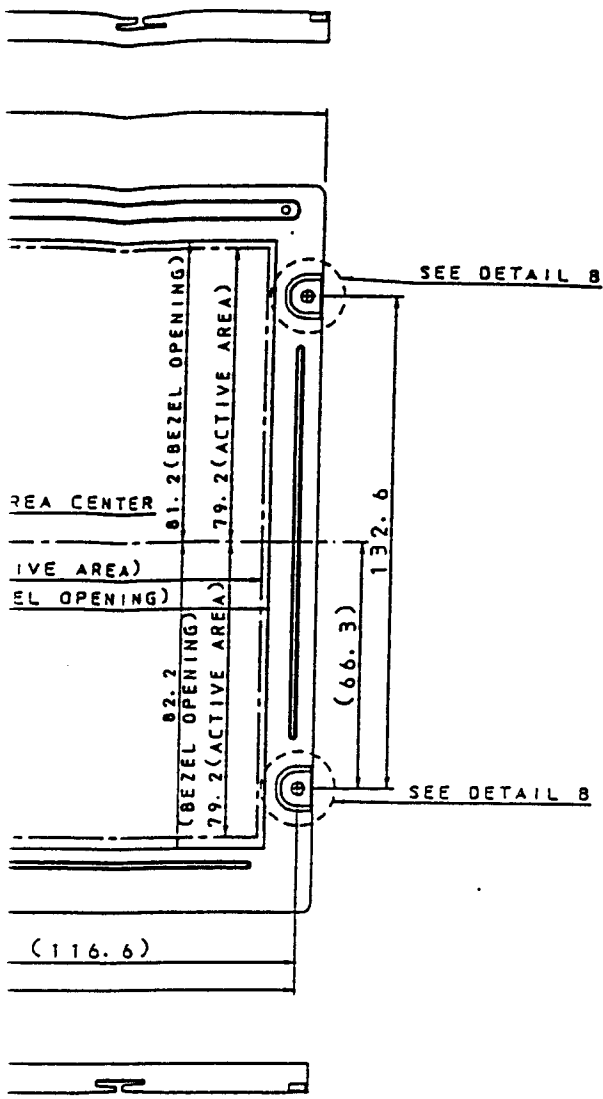
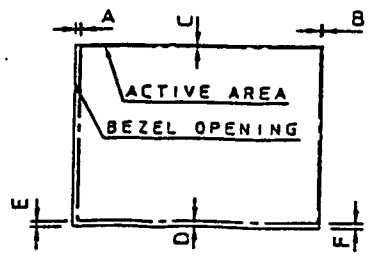

Fig1 LQ10D34G OUTLINE DIMENSIONS

12B



BEZEL/DISPLAY POSITION



⊙	TOLERANCE	X-DIRECTION	A	: 3.0	± 0.8
⊙	TOLERANCE	X-DIRECTION	B	: 2.0	± 0.8
⊙	TOLERANCE	Y-DIRECTION	C	: 2.0	± 0.8
⊙	TOLERANCE	Y-DIRECTION	D	: 3.0	± 0.8
⊙	OBliquITY	OF DISPLAY AREA	FE	FI	< 0.8

NOTES
 *UNSPECIFIED TOLERANCE TO BE ±0.5