 **PART No. EN4TD24428LG**
for more information visit
www.hammfg.com
Data subject to change without notice
Isometric drawing Not to Scale

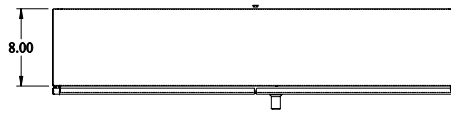

TOP VIEW

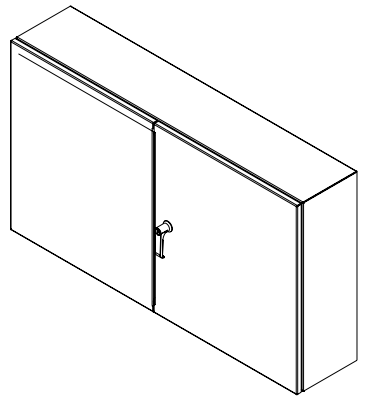

BACK VIEW

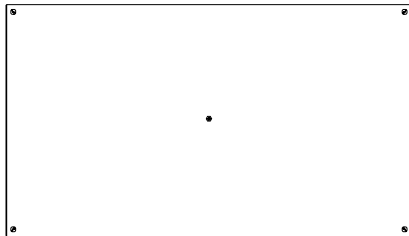
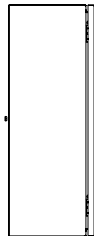

LEFT SIDE VIEW

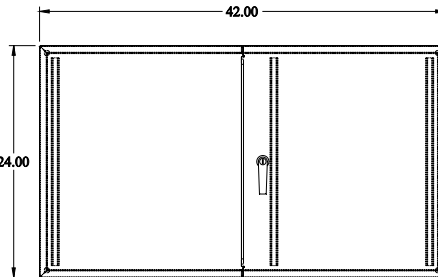

FRONT VIEW

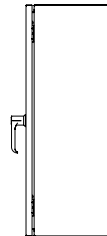

RIGHT SIDE VIEW

ISOMETRIC VIEW

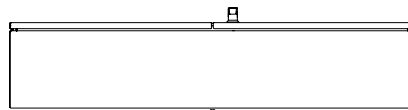

BOTTOM VIEW