

## SMD Temperature Compensated Crystal Oscillator (PLUTO)

A series of lead free surface mountable TCXO/TCVCXO for medium to high volume applications where small size (5 x 3.2 mm) and high performance are prerequisites.

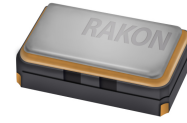

### Product description

The CFPT9300 uses Rakon's proprietary ASIC 'Pluto™', a single chip oscillator and analogue compensation circuit, capable of sub 0.3ppm performance over an extended temperature range. Its ability to function down to a supply voltage of 2.4V and low power consumption makes it particularly suitable for mobile applications.

### Applications

- Communications
- Other

### Features

- HCMOS or clipped sinewave output
- Stability  $\pm 0.2\text{ppm}$  over  $-20/70^\circ\text{C}$  or  $\pm 0.3\text{ppm}$  over  $-40/85^\circ\text{C}$

### Specifications

#### 1.0 SPECIFICATION REFERENCES

Line	Parameter	Description
1.1	Model description	CFPT9300
1.2	RoHS compliant	Yes
1.3	Package size	5.0 x 3.2 x 1.7 mm (see model drawing)

#### 2.0 FREQUENCY CHARACTERISTICS (ALL)

Line	Parameter	Test Condition	Value	Unit
2.1	Frequency range	Frequency range available (note 1 & 2)	1.25 to 52	MHz
2.2	Frequency calibration	Initial calibration @ 25°C	$\pm 1$ max	ppm
2.3	Frequency stability over temperature	Reference to $(F_{\text{max}} + F_{\text{min}})/2$	$\pm 0.2$ to 2	ppm
2.4	Temperature range	Operating temperature range over which temperature stability is measured	-40 to 85	°C
2.5	Reflow shift	Measured $\geq 60$ minutes after reflow	$\pm 1$ max	ppm

#### 3.0 FREQUENCY CHARACTERISTICS (CLIPPED SINEWAVE)

Line	Parameter	Test Condition	Value	Unit
3.1	Supply voltage stability	$\pm 5\%$ variation, reference to frequency at nominal supply voltage, typical	$\pm 0.1$	ppm
3.2	Load sensitivity	$\pm 10\%$ variation, reference to frequency at nominal load, typical	$\pm 0.05$	ppm

#### 4.0 FREQUENCY CHARACTERISTICS (HCMOS)

Line	Parameter	Test Condition	Value	Unit
4.1	Supply voltage stability <20MHz	±5% variation, reference to frequency at nominal supply voltage, typical	±0.1	ppm
4.2	Supply voltage stability 20 - 35MHz	±5% variation, reference to frequency at nominal supply voltage, typical	±0.3	ppm
4.3	Supply voltage stability 35 - 52MHz	±5% variation, reference to frequency at nominal supply voltage, typical	±0.5	ppm
4.4	Load sensitivity <20MHz	±5pF variation, reference to frequency at nominal load, typical	±0.2	ppm
4.5	Load sensitivity 20 - 35MHz	±5pF variation, reference to frequency at nominal load, typical	±0.3	ppm
4.6	Load sensitivity 35 - 52MHz	±5pF variation, reference to frequency at nominal load, typical	±0.5	ppm

#### 5.0 LONG TERM STABILITY

Line	Parameter	Test Condition	Value	Unit
5.1	In first year	≤20MHz	±1 max	ppm
5.2	In first year	>20MHz	±2 max	ppm
5.3	For 10 years	≤20MHz	±3 max	ppm
5.4	For 10 years	>20MHz	±5 max	ppm

#### 6.0 POWER SUPPLY

Line	Parameter	Test Condition	Value	Unit
6.1	Supply voltage	Nominal supply voltage (±10%) to be specified as part of model code	2.4 to 6	V
6.2	Current HCMOS	typically: $1 + \text{frequency}(\text{MHz}) * \text{supply}(\text{V}) * \{\text{load}(\text{pF}) + 15\} * 10^{-3} \text{mA}$ e.g 20MHz, 3.3V, 15pF approximately equals 3mA		
6.3	Current Clipped Sinewave	typically: $1 + \text{frequency}(\text{MHz}) * 1.2 * \{\text{load}(\text{pF}) + 30\} * 10^{-3} \text{mA}$ e.g 20MHz, 10pF approximately equals 2mA		

#### 7.0 CONTROL VOLTAGE

Line	Parameter	Test Condition	Value	Unit
7.1	Control voltage range		0.5 to 2.5	V
7.2	Frequency tuning	Frequency ≤20MHz (note 3)	±5 min	ppm
7.3	Frequency tuning	Frequency >20MHz (note 3)	±7 min	ppm
7.4	Frequency tuning	Custom request	±5 to 20	ppm
7.5	Port input impedance	Measured between control voltage and GND pin	100 min	kΩ
7.6	Linearity		2 max	%
7.7	Slope	Positive		
7.8	Modulation bandwidth		2 min	kHz

#### 8.0 OSCILLATOR OUTPUT- CLIPPED SINEWAVE

Line	Parameter	Test Condition	Value	Unit
8.1	Output waveform	Clipped sinewave		
8.2	Output voltage level	Peak to peak voltage measured at minimum supply voltage	0.8 min	V
8.3	Output load resistance		10	kΩ
8.4	Output load capacitance		10	pF

## 9.0 OSCILLATOR OUTPUT-HCMOS

Line	Parameter	Test Condition	Value	Unit
9.1	Output waveform	HCMOS. Refer to note 2 re AC MOS		
9.2	Output voltage level low		0.1 max	Vs
9.3	Output voltage level high		0.9 min	Vs
9.4	Rise and fall times		8 max	ns
9.5	Duty cycle	at 50% level	45 to 55	%
9.6	Load		15	pF

## 10.0 PHASE NOISE

Line	Parameter	Test Condition	Value	Unit
10.1	SSB phase noise power density at 1Hz offset	Typical value for a 14.4MHz oscillator at 25°C	-70	dBc/Hz
10.2	SSB phase noise power density at 10Hz offset	Typical value for a 14.4MHz oscillator at 25°C	-95	dBc/Hz
10.3	SSB phase noise power density at 100Hz offset	Typical value for a 14.4MHz oscillator at 25°C	-115	dBc/Hz
10.4	SSB phase noise power density at 1kHz offset	Typical value for a 14.4MHz oscillator at 25°C	-135	dBc/Hz
10.5	SSB phase noise power density at 10kHz offset	Typical value for a 14.4MHz oscillator at 25°C	-140	dBc/Hz
10.6	SSB phase noise power density at 100kHz offset	Typical value for a 14.4MHz oscillator at 25°C	-145	dBc/Hz

## 11.0 ENVIRONMENTAL

Line	Parameter	Description
11.1	Shock	IEC 60068-2-27 test Ea. 1500gn acceleration for 0.5ms duration, half sine pulse, 3 shocks in each direction along three mutually perpendicular axes at octave per minute
11.2	Vibration	IEC 60068-2-6 test Fc. 10-60Hz 1.5mm displacement, 60-2000Hz at 20gn, 4 hours in each of three mutually perpendicular axes at 1 octave per minute
11.3	Storage temperature	-55°C to 125°C

## 12.0 PIN CONNECTIONS

Line	Parameter	Description
12.1	Pin 1	Voltage Control (leave unconnected in case the 'no frequency adjust' option has been ordered)
12.2	Pin 2	Ground
12.3	Pin 3	Output
12.4	Pin 4	Supply Voltage, Vs

## 13.0 MARKING

Line	Parameter	Description
13.1	Type	Laser marked
13.2	Line 1	[ R XXX ] Rakon, manufacturing identifier (XXX)
13.3	Line 2	[ Δ 0000 YW ] Pad 1 / static sensitivity identifier (Δ), abbreviated part number (0000), device date code (YW)

## 14.0 MANUFACTURING INFORMATION

Line	Parameter	Description
14.1	Reflow shift	Solder reflow processes as per profile attached (see reflow profile diagram)
14.2	Packaging description	Quantities >100 pieces will be supplied on tape and reel

## 15.0 NOTES

Line	Parameter	Description
15.1	1	Frequency range available dependent on output type. Available in HCMOS output: 1.25-52MHz and clipped sinewave output: 10-52MHz
15.2	2	Available on request: ACMOS, 50pF max load or sinewave 10k $\Omega$ //10pF, DC coupled
15.3	3	Other tuning ranges may be available on request

# Drawing Name: CFPT9300 Model Drawing

## MODEL DRAWING

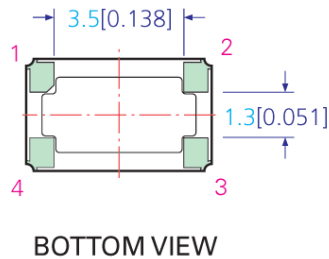
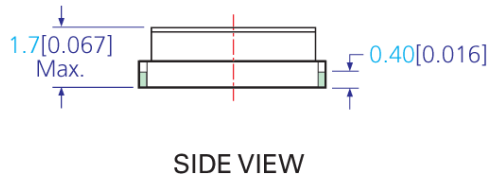
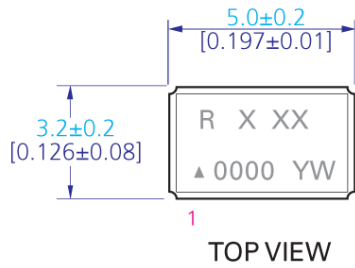

## RECOMMENDED PAD LAYOUT - TOP VIEW

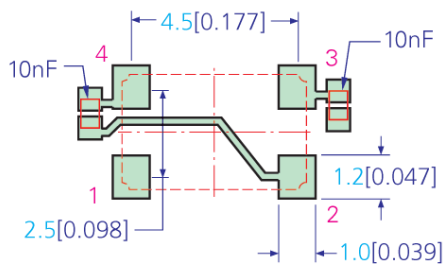

### NOTE:

- 1) Pin connections are detailed in the specification.
- 2) For correct operation a 10nF supply de-coupling capacitor should be placed next to the device, as shown above. If an AC coupled output is required a 10nF should be placed in series with output pad 3.

TITLE: CFPT9300 MODEL OUTLINE DRAWING

FILENAME: CFPT9300\_MD

RELATED DRAWINGS:

REVISION: B

DATE: 22-Jul-10

SCALE: 5 : 1

Millimeters [inch]

Tolerance:

XX = ±0.5

X.X = ±0.2

X.XX = ±0.10

X.XXX = ±0.05

X° = ±1.0°

Hole = ±0.10

**rakon**

©2009 Rakon Limited

**Drawing Name: CFPT9300 Model Code Builder**

**MODEL CODE BUILDER**

**CFPT 930 X XX X XX**

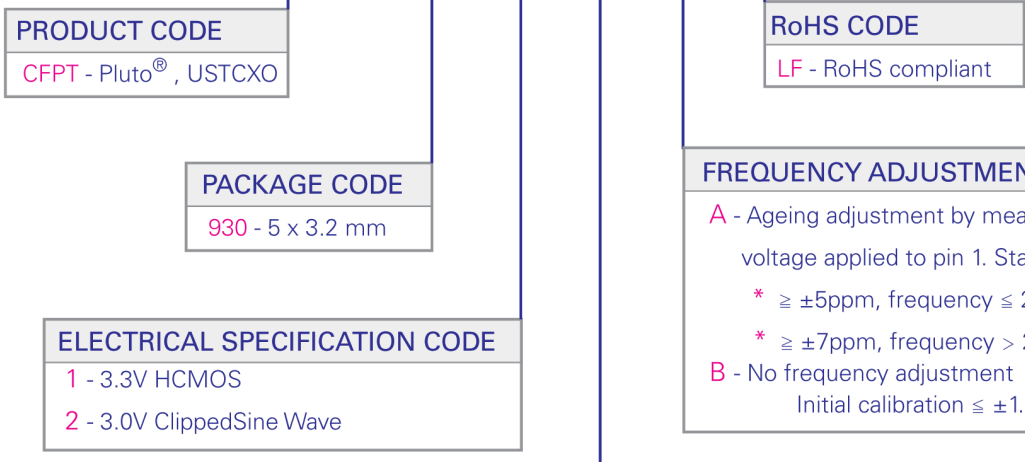

**PRODUCT CODE**  
CFPT - Pluto<sup>®</sup>, USTCXO

**RoHS CODE**  
LF - RoHS compliant

**PACKAGE CODE**  
930 - 5 x 3.2 mm

**ELECTRICAL SPECIFICATION CODE**  
1 - 3.3V HCMOS  
2 - 3.0V ClippedSine Wave

**FREQUENCY ADJUSTMENT CODE**  
A - Ageing adjustment by means of external control voltage applied to pin 1. Standard option.  
\*  $\geq \pm 5\text{ppm}$ , frequency  $\leq 20\text{MHz}$   
\*  $\geq \pm 7\text{ppm}$ , frequency  $> 20\text{MHz}$   
B - No frequency adjustment  
Initial calibration  $\leq \pm 1.0\text{ppm}$

**TEMPERATURE STABILITY CODE**

Frequency Stability vs Operating Temperature Range

$\pm 0.2\text{ppm}$	$\pm 0.3\text{ppm}$	$\pm 0.5\text{ppm}$	$\pm 1.0\text{ppm}$	$\pm 2.0\text{ppm}$	
MS*	AS*	ES*	FS	GS	-20 to 70°C
	AX*	EX*	FX	GX	-40 to 85°C

\* Code may not be available for all frequency

TITLE: CFPT9300 MODEL CODE BUILDER

FILENAME: CFPT9300\_MC

RELATED DRAWINGS:

REVISION: A

DATE: 25-Feb-11

SCALE: NTS

Millimeters [inch]

Tolerance:

XX =  $\pm 0.5$

X.X =  $\pm 0.2$

X.XX =  $\pm 0.10$

X.XXX =  $\pm 0.05$

X<sup>o</sup> =  $\pm 1.0^{\circ}$

Hole =  $\pm 0.10$



©2009 Rakon Limited

Drawing Name: CFPT9300 Series Test Circuit

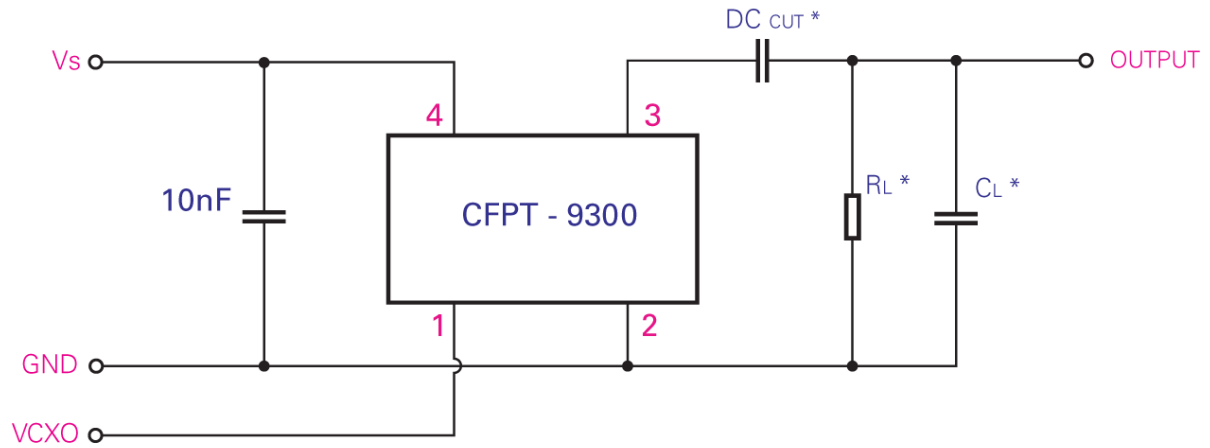

\* DC cut capacitor required for AC coupled Clipped sinewave.

\* Load 15pF (HCMOS or 10kΩ // 10pF (Clipped sinewave), inclusive of probe and jig capacitance.

TITLE: CFPT9300 SERIES TEST CIRCUIT

RELATED DRAWINGS:

FILENAME: CFPT9300\_TC

REVISION: A

DATE: 12-May-10

SCALE: NTS

Millimetres [inch]

**rakon**

©2009 Rakon Limited

Drawing Name: CFPT9300 Output Waveform Chart

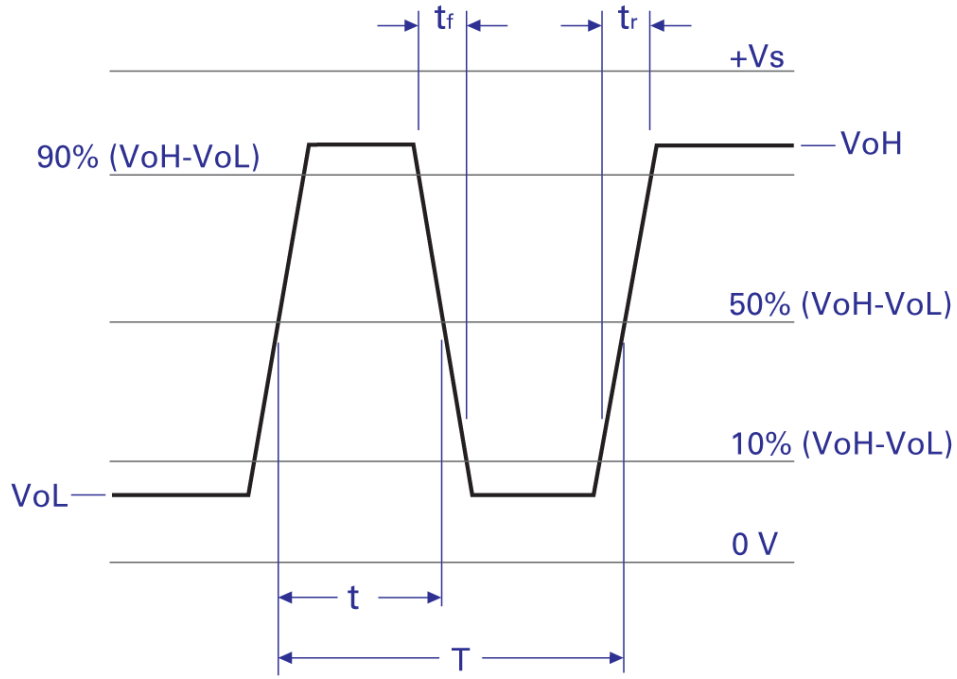

TITLE: CFPT9300 SERIES OUTPUT WAVEFORM - HCMOS

FILENAME: CFPT9300\_OW

RELATED DRAWINGS:

REVISION: A

DATE: 13-May-10

SCALE: NTS

Millimetres [inch]

**rakon**

©2009 Rakon Limited



# Drawing Name: CFPT9300 Reflow Profile

## Pb-Free Reflow Soldering Profile \*

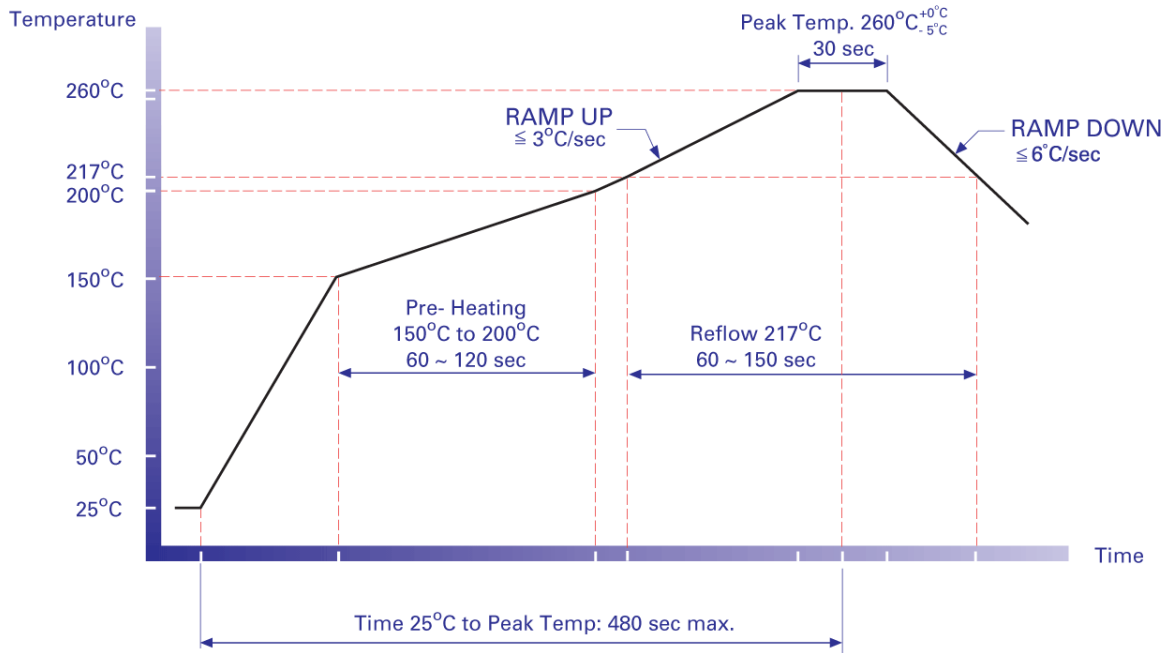

**\* NOTE:**

This profile was used during the qualification testing of the product and therefore represents worst case conditions. It is not recommended for use by the customer in the actual assembly of these parts.

TITLE: CFPT9300 SERIES REFLOW PROFILE

FILENAME: CFPT9300\_RF

RELATED DRAWINGS:

REVISION: B

DATE: 09-Sep-10

SCALE: NTS

Millimeters [inch]

Tolerance:

XX = ±0.5

X.X = ±0.2

X.XX = ±0.10

X.XXX = ±0.05

X° = ±1.0°

Hole = ±0.10

**rakon**

©2009 Rakon Limited