

Power MOSFET 200 mAmps, 50 Volts N-Channel SC88

Typical applications are dc-dc converters, power management in portable and battery-powered products such as computers, printers, PCMCIA cards, cellular and cordless telephones.

- Low Threshold Voltage ($V_{GS(th)}$: 0.5V...1.5V) makes it ideal for low voltage applications
- Miniature SC88 Surface Mount Package saves board space
- Pb-Free Package May be Available. The G-Suffix Denotes a Pb-Free Lead Finish
- S- Prefix for Automotive and Other Applications Requiring Unique Site and Control Change Requirements; AEC-Q101 Qualified and PPAP Capable.

MAXIMUM RATINGS ($T_A = 25^\circ\text{C}$ unless otherwise noted)

Rating	Symbol	Value	Unit
Drain-to-Source Voltage	V_{DSS}	50	Vdc
Gate-to-Source Voltage – Continuous	V_{GS}	± 20	Vdc
Drain Current			mA
– Continuous @ $T_A = 25^\circ\text{C}$	I_D	200	
– Pulsed Drain Current ($t_p \leq 10 \mu\text{s}$)	I_{DM}	800	
Total Power Dissipation @ $T_A = 25^\circ\text{C}$	P_D	380	mW
Operating and Storage Temperature Range	T_J, T_{stg}	- 55 to 150	$^\circ\text{C}$
Thermal Resistance – Junction-to-Ambient	$R_{\theta JA}$	328	$^\circ\text{C/W}$
Maximum Lead Temperature for Soldering Purposes, for 10 seconds	T_L	260	$^\circ\text{C}$

LBSS138DW1T1G S-LBSS138DW1T1G

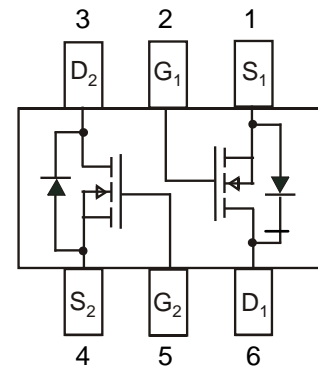
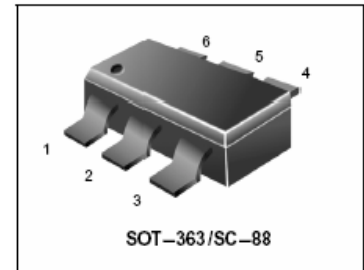

ORDERING INFORMATION

Device	Marking	Shipping
LBSS138DW1T1G S-LBSS138DW1T1G	J1	3000 Tape & Reel
LBSS138DW1T1G S-LBSS138DW1T1G	J1	10000 Tape & Reel

LBSS138DW1T1G , S-LBSS138DW1T1G

ELECTRICAL CHARACTERISTICS ($T_A = 25^\circ\text{C}$ unless otherwise noted)

Characteristic	Symbol	Min	Typ	Max	Unit
----------------	--------	-----	-----	-----	------

OFF CHARACTERISTICS

Drain-to-Source Breakdown Voltage ($V_{GS} = 0 \text{ Vdc}$, $I_D = 250 \mu\text{Adc}$)	$V_{(BR)DSS}$	50	–	–	Vdc
Zero Gate Voltage Drain Current ($V_{DS} = 25 \text{ Vdc}$, $V_{GS} = 0 \text{ Vdc}$) ($V_{DS} = 50 \text{ Vdc}$, $V_{GS} = 0 \text{ Vdc}$)	I_{DSS}	–	–	0.1 0.5	μAdc
Gate-Source Leakage Current ($V_{GS} = \pm 20 \text{ Vdc}$, $V_{DS} = 0 \text{ Vdc}$)	I_{GSS}	–	–	± 0.1	μAdc

ON CHARACTERISTICS (Note 1.)

Gate-Source Threshold Voltage ($V_{DS} = V_{GS}$, $I_D = 1.0 \text{ mAdc}$)	$V_{GS(th)}$	0.5	–	1.5	Vdc
Static Drain-to-Source On-Resistance ($V_{GS} = 2.75 \text{ Vdc}$, $I_D < 200 \text{ mAdc}$, $T_A = -40^\circ\text{C}$ to $+85^\circ\text{C}$) ($V_{GS} = 5.0 \text{ Vdc}$, $I_D = 200 \text{ mAdc}$)	$r_{DS(on)}$	–	5.6 –	10 3.5	Ohms

DYNAMIC CHARACTERISTICS

Input Capacitance	($V_{DS} = 25 \text{ Vdc}$, $V_{GS} = 0$, $f = 1 \text{ MHz}$)	C_{iss}	–	42	–	pF
Output Capacitance	($V_{DS} = 25 \text{ Vdc}$, $V_{GS} = 0$, $f = 1 \text{ MHz}$)	C_{oss}	–	15	–	
Transfer Capacitance	($V_{DG} = 25 \text{ Vdc}$, $V_{GS} = 0$, $f = 1 \text{ MHz}$)	C_{rss}	–	3	–	

SWITCHING CHARACTERISTICS (Note 2.)

Turn-On Delay Time	($V_{DD} = 30 \text{ Vdc}$, $I_D = 0.2 \text{ Adc}$,)	$t_{d(on)}$	–	5	–	ns
Turn-Off Delay Time		$t_{d(off)}$	–	7	–	

1. Pulse Test: Pulse Width $\leq 300 \mu\text{s}$, Duty Cycle $\leq 2\%$.
2. Switching characteristics are independent of operating junction temperature.

LBSS138DW1T1G , S-LBSS138DW1T1G

Typical Characteristics (TA=25°C Noted)

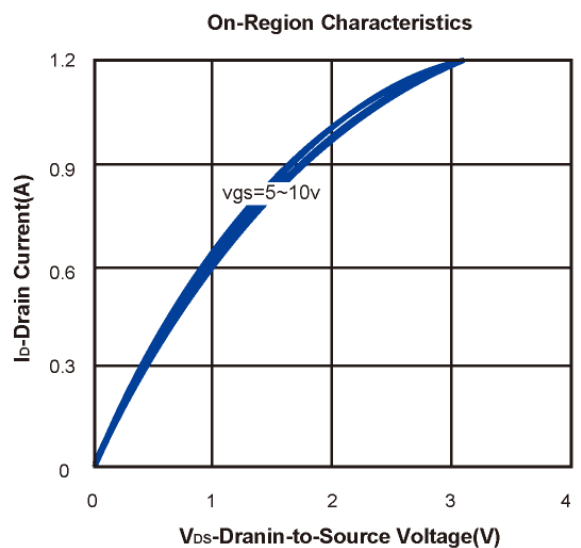
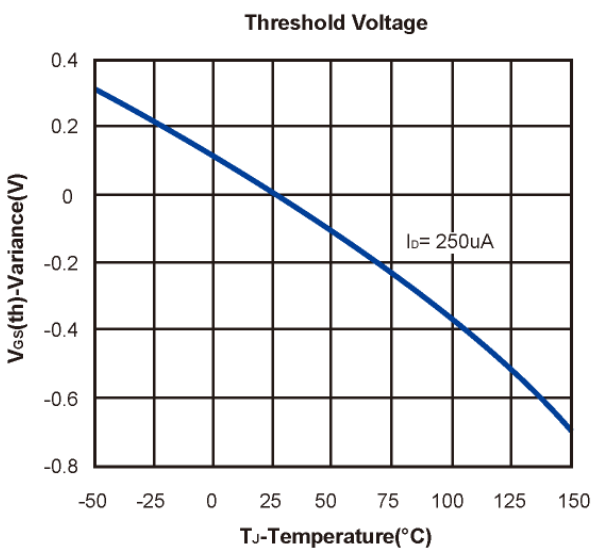
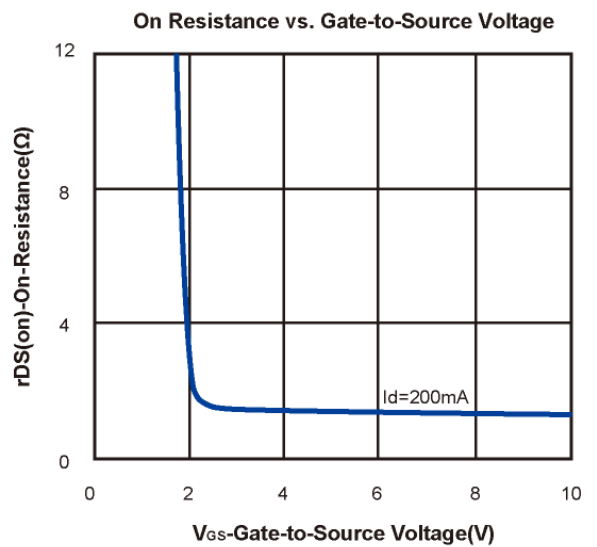
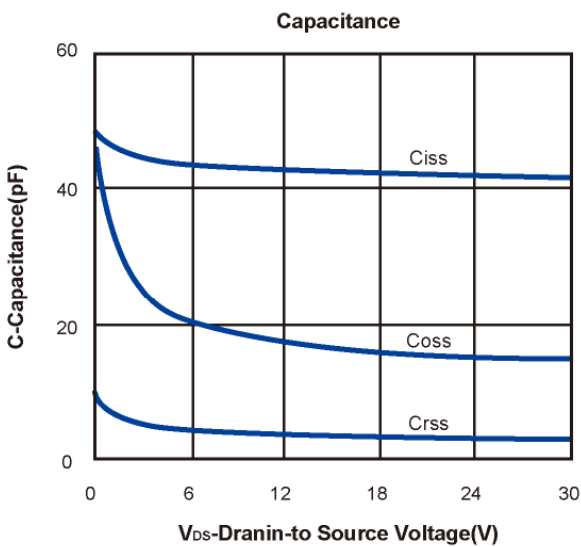
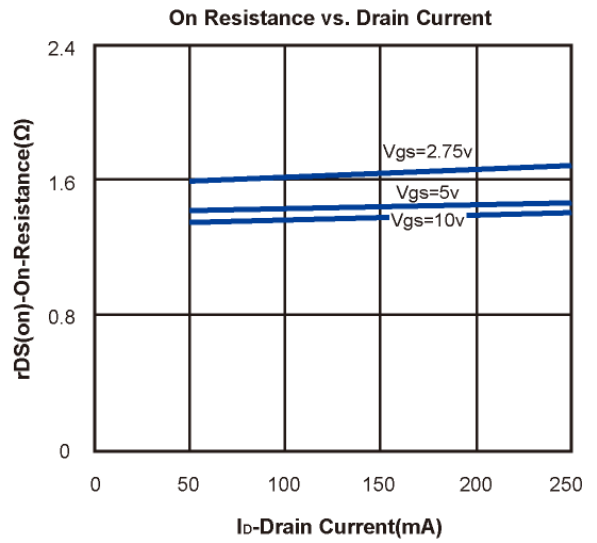
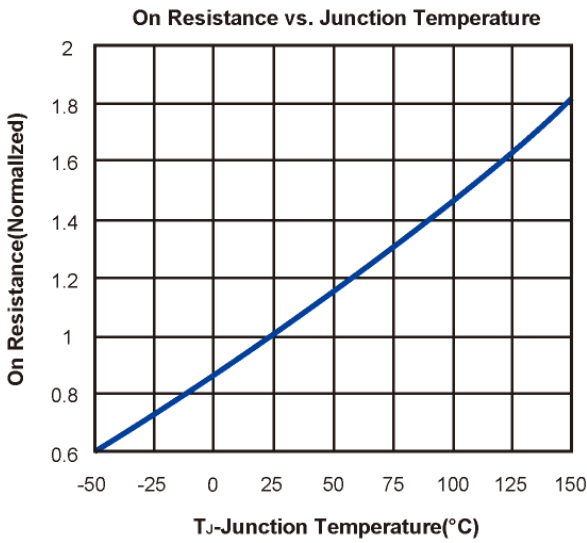

LBSS138DW1T1G , S-LBSS138DW1T1G

Typical Characteristics (TA = 25°C Noted)

Gate Charge

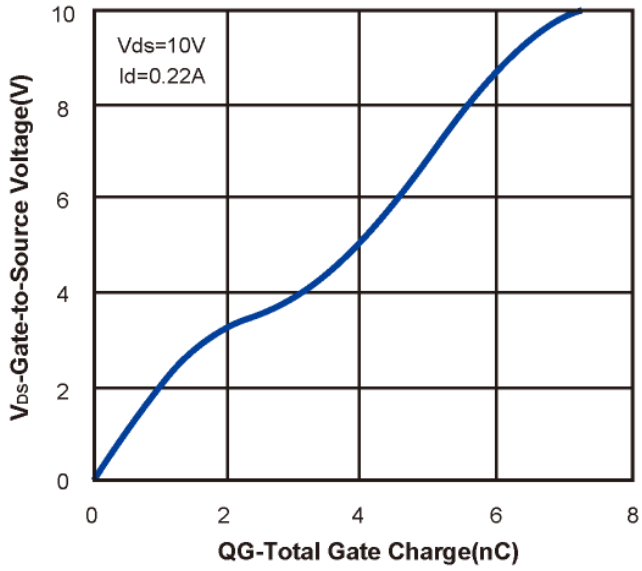

Body-diode characteristics

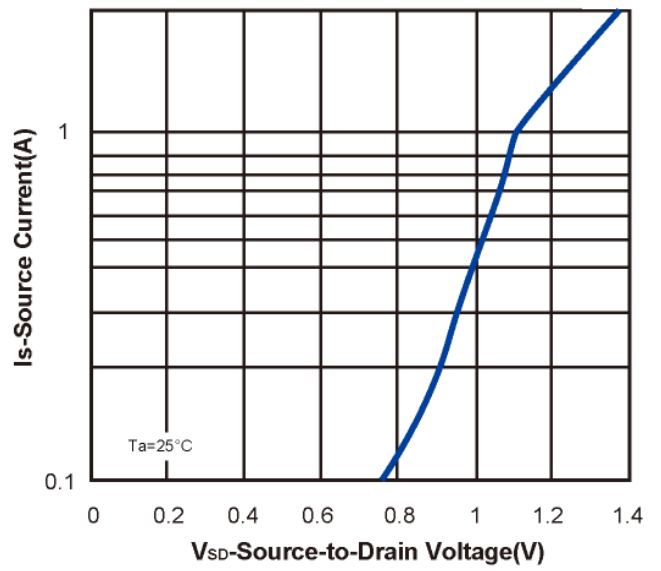

LBSS138DW1T1G , S-LBSS138DW1T1G

SC-88 (SOT-363)
CASE 419B-02
ISSUE T

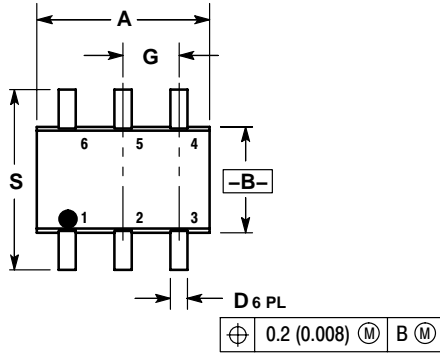

- NOTES:
1. DIMENSIONING AND TOLERANCING PER ANSI Y14.5M, 1982.
2. CONTROLLING DIMENSION: INCH.
3. 419B-01 OBSOLETE, NEW STANDARD 419B-02.

DIM	INCHES		MILLIMETERS	
	MIN	MAX	MIN	MAX
A	0.071	0.087	1.80	2.20
B	0.045	0.053	1.15	1.35
C	0.031	0.043	0.80	1.10
D	0.004	0.012	0.10	0.30
G	0.026 BSC		0.65 BSC	
H	---	0.004	---	0.10
J	0.004	0.010	0.10	0.25
K	0.004	0.012	0.10	0.30
N	0.008 REF		0.20 REF	
S	0.079	0.087	2.00	2.20

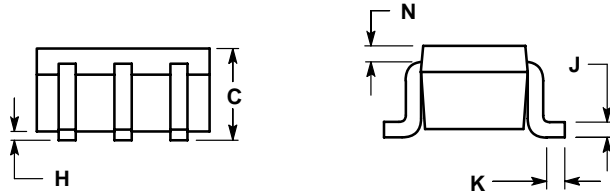

- STYLE 1:
PIN 1. EMITTER 2
2. BASE 2
3. COLLECTOR 1
4. EMITTER 1
5. BASE 1
6. COLLECTOR 2

SOLDERING FOOTPRINT*

