

1 Hz to 400 kHz*
Low Noise Fixed Frequency

**4 - Pole Single Power Supply
Anti-Aliasing Low-Pass Filters**

Description:

The D94 Series of small 4-pole fixed-frequency, precision active filters provide high performance linear active filtering in a compact package, with a broad range of corner frequencies and a choice of Butterworth or Bessel transfer functions. These filters are designed to work with up to 16 Bit A/D converters. These fully self-contained units require no external components or adjustments.

Each model comes factory tuned to a user-specified corner frequency between 1 Hz and 400 kHz* and operate with low total harmonic distortion over a wide dynamic input voltage range from non-critical single +5VDC to +18VDC power supply. Each filter has a built in internal +6VDC and -6VDC power supplies to power the filter.

Features/Benefits:

- Low harmonic distortion and wide signal-to-noise ratio to 16 bit resolution.
- Available with Single or Differential inputs.
- Available with DC coupled or AC coupled inputs. (The AC corner frequency is a single pole at 2 Hz.)
- Compact 1.5"L x 2.0"W x 0.4"H minimizes board space requirements.
- Plug-in ready-to-use, reducing engineering design and manufacturing cycle time.
- Factory tuned, no external clocks or adjustments needed.
- Available in Butterworth or Bessel transfer functions to meet a wide range of applications.
- Requires a single +5V to +18V power supply to operate (The module generates ± 6 VDC internally to operate the filter).
- One to one offset input that works with your A/Ds reference output to set the output of the filter in the center of your A/Ds input range.
- Available with built in gains from 0 dB to 60 dB.

* Bessel 1 Hz to 200 Khz

Applications

- Anti-alias filtering
- Data acquisition systems
- Communication systems and electronics
- Medical electronics equipment and research
- Aerospace, navigation and sonar applications
- Sound and vibration testing
- Acoustic and vibration analysis and control
- Noise elimination
- Signal reconstruction



Available Low-Pass Models:

- D94L4B** 4-Pole Butterworth
- D94L4L** 4-Pole Bessel



1 Hz to 400 kHz*
Low Noise Fixed Frequency

4 - Pole Single Power Supply
Anti-Aliasing Low-Pass Filters

	D94L4B	D94L4L
Transfer Function	4-Pole Butterworth	4-Pole Bessel
Size	1.5" x 2.0" x 0.4"	1.5" x 2.0" x 0.4"
Range f_c	1.0 Hz to 400 kHz	1.0 Hz to 200 kHz
Theoretical Transfer Characteristics	Appendix A Page 7	Appendix A Page 2
Passband Ripple (theoretical)	0.0 dB	0.0 dB
DC Voltage Gain (non-inverting)	0 ± 0.1 dB max. 0 ± 0.05 dB typ.	0 ± 0.1 dB max. 0 ± 0.05 dB typ.
Stopband Attenuation Rate	24 dB/octave	21 dB/octave
Cutoff Frequency Stability Amplitude Phase	f_c ± 1% max. ± 0.01%/°C -3 dB -180°	f_c ± 1% max. ± 0.01%/°C -3 dB -121°
Filter Attenuation (theoretical)	0.67 dB 0.80 f_c 3.01 dB 1.00 f_c 30.0 dB 2.37 f_c 40.0 dB 3.16 f_c	1.86 dB 0.80 f_c 3.01 dB 1.00 f_c 30.0 dB 3.50 f_c 40.0 dB 4.72 f_c
Amplitude Accuracy (theoretical)	0 – 0.8 f_c ±0.2 dB max. ±0.1 dB typ.	0 – 0.8 f_c ±0.2 dB max. ±0.1 dB typ.
	0.8 f_c – 1.0 f_c ±0.3 dB max. ±0.15 dB typ.	0.8 f_c – 1.0 f_c ±0.3 dB max. ±0.15 dB typ.
(THD) Total Harmonic Distortion @ 1 kHz	<-100 dB	<-100 dB
Wide Band Noise (5 Hz – 2 MHz)	< 200 μ Vrms	< 200 μ Vrms
SINAD	<-100 dB	<-100 dB

Specifications
 (25°C and $V_s + 5$ VDC to + 18 VDC)

Pin-Out and Package Data
Ordering Information
Analog Input Characteristics¹

Impedance	1 M Ω
Voltage Range	± 6 V peak
Max. Safe Voltage	± 6 V

Analog Output Characteristics

Impedance (Closed Loop)	1 Ω typ., 10 Ω max.
Linear Operating Range ³	± 5 V
Maximum Current ²	± 5 mA
Offset Voltage ³	± 5 VDC

Power Supply ($\pm V$)

Rated Voltage	+ 5 VDC to + 18 VDC
Quiescent Current	~ 110 mA

Temperature Range

Operating	0°C to +70°C
Storage	-25°C to +85°C

Notes:

1. Input and output signal voltage referenced to supply common.
2. Output is short circuit protected to common. DO NOT CONNECT TO $\pm V_s$.
3. Any voltage applied to the offset pin appears at the output and an output offset. Note that if, for instance, the offset pin is at 2 VDC the maximum linear operating range will be ± 3 V not ± 5 V. This is because you cannot exceed +5V or -5V linear operating range. Any voltage applied to the Offset Pin is low pass filtered to remove noise.
4. Units operate with or without offset pin connected.
5. How to specify Corner Frequency. Corner frequency is specified by attaching a three-digit frequency designator to the basic model number. Corner frequencies can range from 1.00 Hz to 400 kHz.

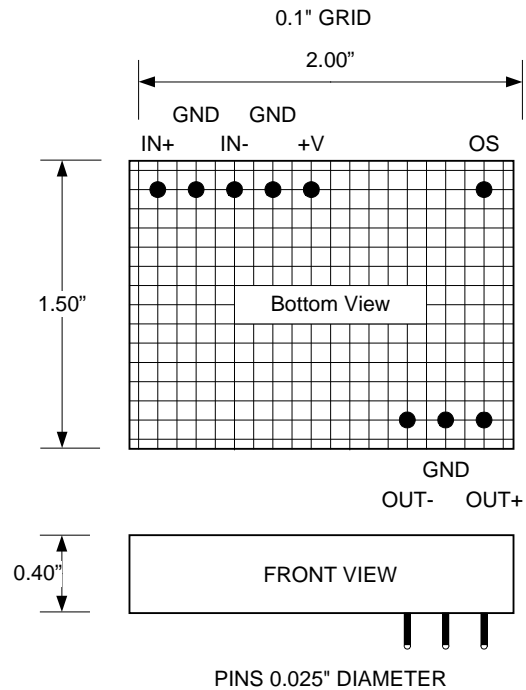
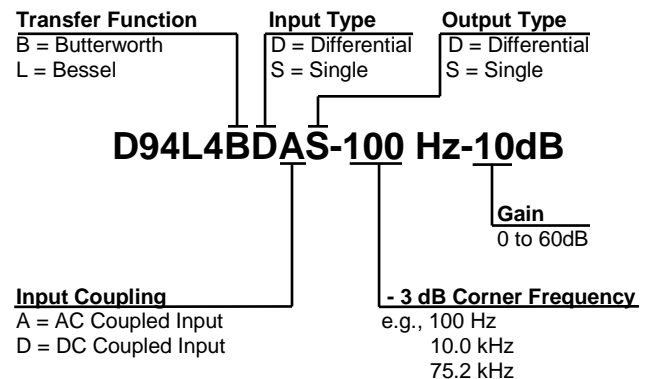
Pin-Out and Package Data

ORDERING INFORMATION



Appendix A

Theoretical Transfer Characteristics

f/fc (Hz)	Amp (dB)	Phase (deg)	Delay ¹ (sec)
0.00	0.00	0.00	.416
0.10	0.00	-15.0	.418
0.20	0.00	-30.1	.423
0.30	-0.00	-45.5	.433
0.40	-0.003	-61.4	.449
0.50	-0.017	-78.0	.474
0.60	-0.072	-95.7	.511
0.70	-0.243	-115	.558
0.80	-0.674	-136	.604
0.85	-1.047	-147	.619
0.90	-1.555	-158	.622
0.95	-2.21	-169	.612
1.00	-3.01	-180	.588
1.10	-4.97	-200	.513
1.20	-7.24	-217	.427
1.30	-9.62	-231	.350
1.40	-12.0	-242	.289
1.50	-14.3	-252	.241
1.60	-16.4	-260	.204
1.70	-18.5	-266	.175
1.80	-20.5	-272	.152
1.90	-22.3	-277	.134
2.00	-24.1	-282	.119
2.25	-28.2	-291	.091
2.50	-31.8	-299	.072
2.75	-35.1	-304	.059
3.00	-38.2	-309	.049
3.25	-41.0	-313	.041
3.50	-43.5	-317	.035
4.00	-48.2	-322	.027
5.00	-55.9	-330	.017
6.00	-62.3	-335	.012
7.00	-67.6	-339	.009
8.00	-72.2	-341	.007
9.00	-76.3	-343	.005
10.0	-80.0	-345	.004

Frequency Response

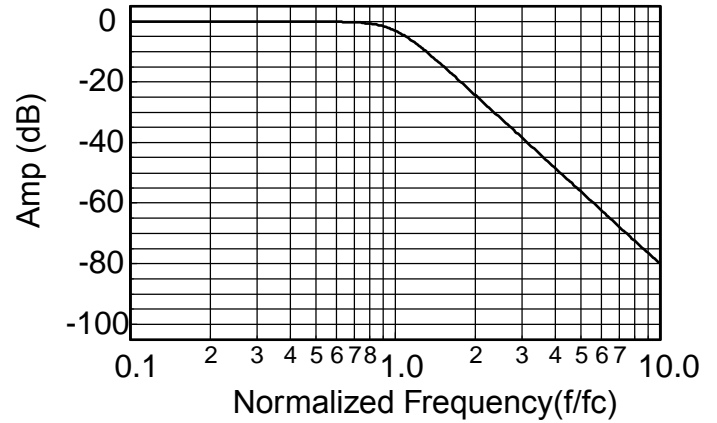

Delay (Normalized)

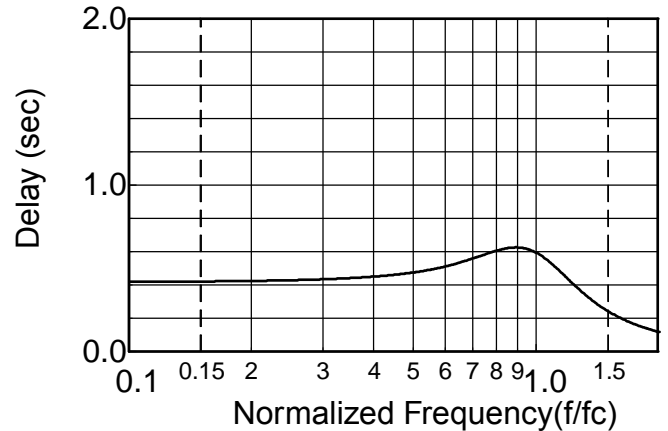

Step Response

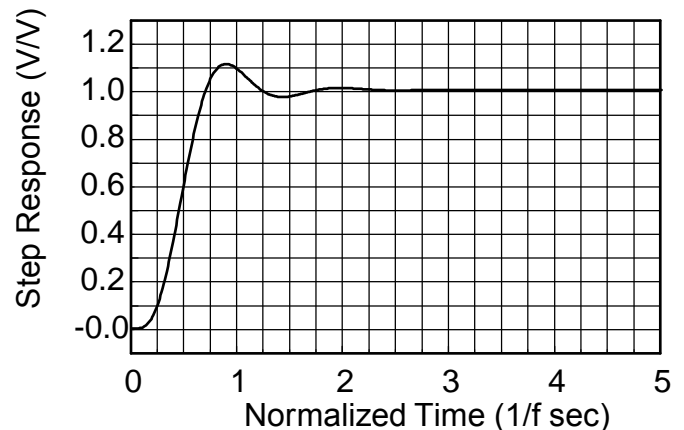

1. Normalized Group Delay:

The above delay data is normalized to a corner frequency of 1.0Hz. The actual delay is the normalized delay divided by the actual corner frequency (fc).

$$\text{Actual Delay} = \frac{\text{Normalized Delay}}{\text{Actual Corner Frequency (fc) in Hz}}$$



Appendix A

Theoretical Transfer Characteristics

f/fc (Hz)	Amp (dB)	Phase (deg)	Delay ¹ (sec)
0.00	0.00	0.00	.336
0.10	-0.028	-12.1	.336
0.20	-0.111	-24.2	.336
0.30	-0.251	-36.3	.336
0.40	-0.448	-48.4	.336
0.50	-0.705	-60.6	.336
0.60	-1.02	-72.7	.336
0.70	-1.41	-84.8	.336
0.80	-1.86	-96.8	.335
0.85	-2.11	-103	.334
0.90	-2.40	-109	.333
0.95	-2.69	-115	.332
1.00	-3.01	-121	.330
1.10	-3.71	-133	.325
1.20	-4.51	-144	.318
1.30	-5.39	-156	.308
1.40	-6.37	-166	.295
1.50	-7.42	-177	.280
1.60	-8.54	-187	.263
1.70	-9.71	-195	.246
1.80	-10.9	-204	.228
1.90	-12.2	-212	.211
2.00	-13.4	-219	.194
2.25	-16.5	-235	.158
2.50	-19.5	-248	.129
2.75	-22.4	-259	.107
3.00	-25.1	-267	.089
3.25	-27.6	-275	.076
3.50	-30.0	-281	.065
4.00	-34.4	-291	.049
5.00	-41.9	-305	.031
6.00	-48.1	-315	.021
7.00	-53.4	-321	.016
8.00	-58.0	-326	.012
9.00	-62.0	-330	.009
10.0	-65.7	-333	.008

Frequency Response

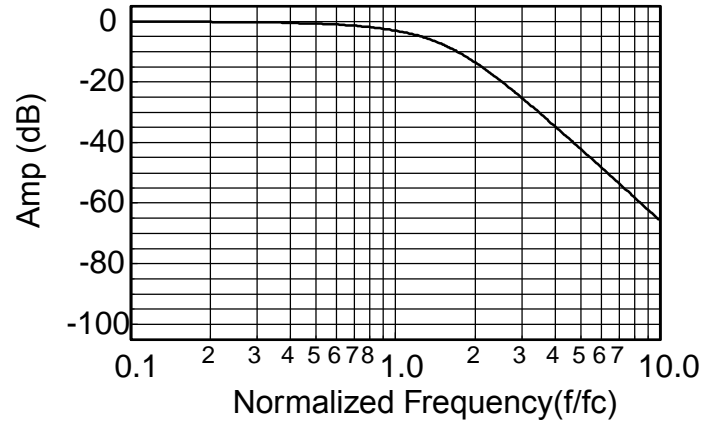

Delay (Normalized)

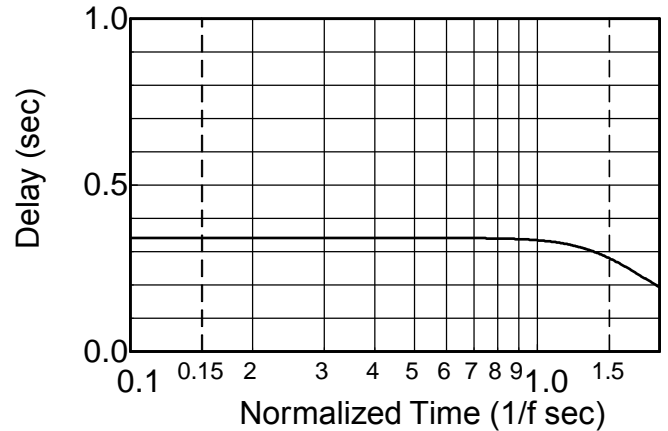

Step Response

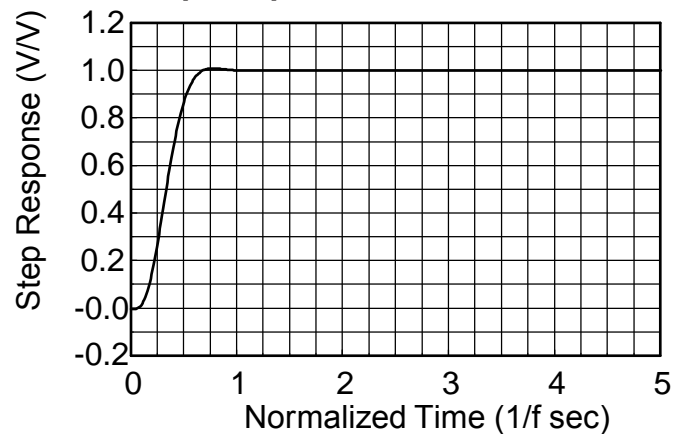

1. Normalized Group Delay:

The above delay data is normalized to a corner frequency of 1.0Hz. The actual delay is the normalized delay divided by the actual corner frequency (fc).

$$\text{Actual Delay} = \frac{\text{Normalized Delay}}{\text{Actual Corner Frequency (fc) in Hz}}$$