

MORNSUN®

URA_YMD-6WR2& URB_YMD-6WR2 Series 6W,ULTRA-WIDE INPUT ISOLATED& REGULATED DUAL/SINGLE OUTPUT DIP PACKAGING, DC-DC CONVERTER



Patent Protected RoHS CE

PART NUMBER SYSTEM

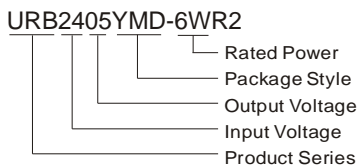

FEATURES

- 4:1 wide input voltage range
- Efficiency up to 88%
- 1.5KVDC isolation
- Short circuit protection
- Output over voltage protection
- Operating Temperature range:
-40°C ~ +85°C
- Industry standard pinout
- Low ripple & noise
- Meet CISPR22/EN55022 CLASS A
- Inverse polarity protection for A2S (chassis mounting) and A4S (DIN-Rail mounting)
- Meet EN60950

APPLICATION

URA_YMD-6WR2&URB_YMD-6WR2 series models provide 6 Watt output power, with 4:1 wide range of 9-36VDC,18-75VDC,output over-voltage and short-circuit protection. And all of them can meet CISPR22/EN55022 CLASS A without external circuit. Typical applications for these converters are industrial, electric power, instrumentation, telecommunication.

SELECTION GUIDE

Model ^①	Input Voltage(VDC)		Output Voltage (VDC)	Output Current (mA)		Input Current (mA)(Typ.)		Reflected Ripple Current (mA,Typ.)	Max. Capacitive Load ^③ (μF)	Efficiency (% ,Typ.) ^④ @Max. Load	Approval
	Nominal (Range)	Max. ^②		Max.	Min.	@Max. Load	@No Load				
URA2405YMD-6WR2	24 (9-36)	40	±5	±600	±30	301	7	20	470	83	CE
URA2412 YMD-6WR2			±12	±250	±12	287			100	87	
URA2415 YMD-6WR2			±15	±200	±10	284			100	88	
URB2403YMD-6WR2			3.3	1500	75	261			1800	79	
URB2405YMD-6WR2			5	1200	60	301			1000	83	
URB2409YMD-6WR2			9	667	33	291			470	85	
URB2412YMD-6WR2			12	500	25	287			100	87	
URB2415YMD-6WR2			15	400	20	284			100	88	
URB2424YMD-6WR2			24	250	12	284			47	88	
URA4805YMD-6WR2			48 (18-75)	80	±5	±600			±30	151	
URA4812YMD-6WR2	±12	±250			±12	143	100	87			
URA4815YMD-6WR2	±15	±200			±10	142	100	88			
URB4803YMD-6WR2	3.3	1500			75	130	1800	79			
URB4805YMD-6WR2	5	1200			60	151	1000	83			
URB4812YMD-6WR2	12	500			25	143	100	87			
URB4815YMD-6WR2	15	400			20	142	100	88			
URB4824YMD-6WR2	24	250			12	142	47	88			

Note: ① Series with suffix "A2S" are chassis mounting, with suffix "A4S" are DIN-Rail mounting, for example URB2405YMD-6WR2A2S is chassis mounting , URB2405YMD-6WR2A4S is DIN-Rail mounting.

②Absolute maximum rating without damage on the converter,but it isn't recommended.

③For dual output converter, the given value is the same for each output.

④The efficiency of "A2S" and "A4S" is approx. 2% lower for the protection of inverse polarity.

INPUT SPECIFICATIONS

Item	Test Conditions	Min.	Typ.	Max.	Unit
Input Surge Voltage (1Sec. max.)	24VDC input	-0.7	--	50	VDC
	48VDC input	-0.7	--	100	

The copyright and authority for the interpretation of the products are reserved by MORNSUN

Start-up Voltage	24VDC input	--	--	9	VDC
	48VDC input	--	--	18	
Input Filter	Pi Filter				

OUTPUT SPECIFICATIONS

Item	Test Conditions	Min.	Typ.	Max.	Unit
Output Voltage Accuracy		--	±1	±2	%
Output Voltage Balance	Dual output, balanced Loads	--	±0.5	±1.5	
Line Regulation	Full load, Input voltage from low to high	--	±0.2	±0.5	
Load Regulation	5% to 100% load	--	±0.5	±1	
Cross Regulation	Dual output, main output 50% load, secondary output from 10% to 100% load	--	--	±5	
Transient Recovery Time	25% load step change	--	300	500	µs
Transient Response Deviation		--	±3	±5	%
Temperature coefficient	100% load	--	--	±0.03	%/°C
Ripple&Noise*	20MHz bandwidth	--	50	75	mVp-p
Output Over Voltage Protection	Input voltage range	110	120	140	%Vo
Output Short Circuit Protection		Continuous, automatic recovery			

Note:* Ripple and noise tested with "parallel cable" method. See detailed operation instructions at *DC-DC Application Notes*.

COMMON SPECIFICATIONS

Item	Test Conditions	Min.	Typ.	Max.	Unit
Isolation Voltage	Input-Output, Tested for 1 minute , leakage current less than 1 mA	1500	--	--	VDC
Isolation Resistance	Input-Output, Test at 500VDC	1000	--	--	MΩ
Isolation Capacitance	Input-Output,100KHz/0.1V	--	1000	--	pF
Switching Frequency	PWM mode	--	300	--	KHz
MTBF	MIL-HDBK-217F @25°C	1000	--	--	K hours
Safety approvals	EN60950				
Case Material	Aluminum Alloy				
Size	PCB mounting	25.4x25.4x11.7			mm
	A2S chassis mounting	76.0x31.5x21.2			
	A4S DIN-Rail mounting	76.0x31.5x25.8			
Weight	PCB mounting	--	13	--	g
	A2S chassis mounting	--	35	--	
	A4S DIN-Rail mounting	--	55	--	

ENVIRONMENTAL SPECIFICATIONS

Item	Test Conditions	Min.	Typ.	Max.	Unit
Storage Humidity	Non condensing	5	--	95	%
Operating Temperature	Power derating (above 71°C, see Figure 4)	-40	--	85	°C
Storage Temperature		-55	--	125	
Max. Case Temperature	Operating Temperature curve range	--	--	105	
Lead Temperature	1.5mm from case for 10 seconds	--	--	300	
Cooling	Free air convection				
Vibration	10-55Hz, 10G, 30 Min. along X, Y and Z				

EMC SPECIFICATIONS

EMI	CE	CISPR22/EN55022	CLASS A (Without External Circuit) / CLASS B (External Circuit Refer to Figure1-② or Figure 3)
	RE	CISPR22/EN55022	CLASS A (Without External Circuit) / CLASS B (External Circuit Refer to Figure1-② or Figure 3)
EMS	ESD	IEC/EN61000-4-2	Contact ±4KV perf. Criteria B
	RS	IEC/EN61000-4-3	10V/m perf. Criteria A
	EFT	IEC/EN61000-4-4	±2KV
IEC/EN61000-4-4		±4KV	perf. Criteria B (External Circuit Refer to Figure 3)

EMS	Surge	IEC/EN61000-4-5	$\pm 2KV$	perf. Criteria B (External Circuit Refer to Figure1-① or Figure 3)
	CS	IEC/EN61000-4-6	3 Vr.m.s	perf. Criteria A
	Voltage dips, short and interruptions immunity	IEC/EN61000-4-29	0%-70%	perf. Criteria B

EMC RECOMMENDED CIRCUIT

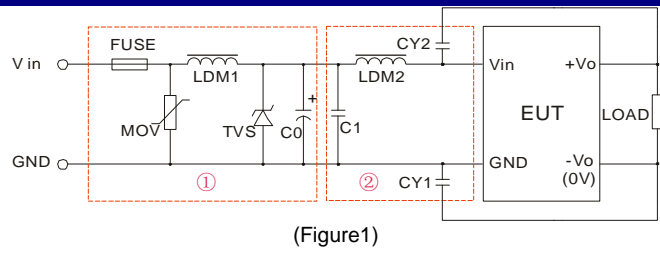

(Figure1)

Recommended external circuit parameters:

Model	Vin:24V	Vin:48V
FUSE	Choose according to actual input current	
MOV	S14K35	S14K60
LDM1	56 μ H	
TVS	SMCJ48A	SMCJ90A
C0	330 μ F/50V	330 μ F/100V
C1	1 μ F/50V	1 μ F/100V
LDM2	4.7 μ H	
CY1	1nF /2KV	
CY2	1nF /2KV	

Note: In Figure 1, part ① is EMS recommended external circuit, part ② is EMI recommended external circuit. Choose according to requirements.

EMC RECOMMENDED CIRCUIT PCB LAYOUT

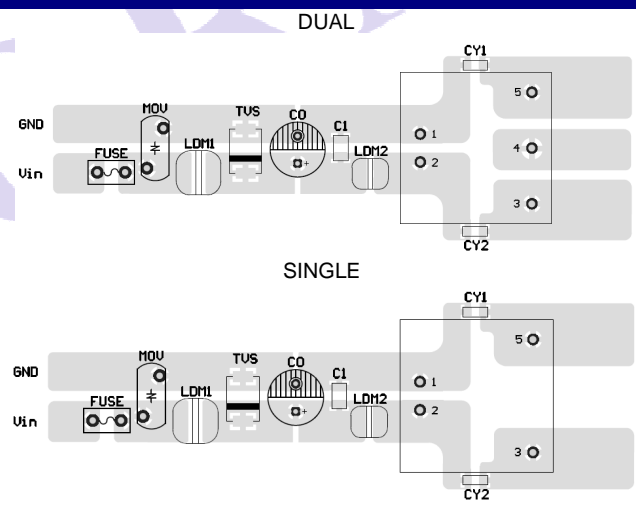

Note: The pad space between input and output (CY1/CY2) must ≥ 2 mm.
(Figure 2)

EMC MODULE APPLICATION CIRCUIT

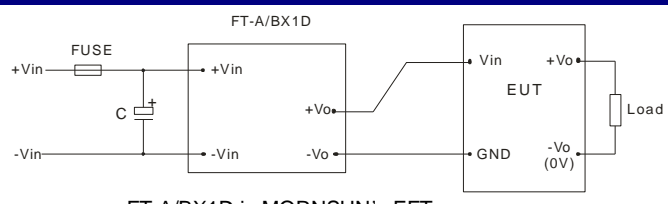

FT-A/BX1D is MORNSUN's EFT suppresser
 For nominal voltage <48V, C $\geq 330\mu$ F/50V
 For nominal voltage =48V, C $\geq 330\mu$ F/100V
 (Figure 3)

EMI TEST WAVEFORM (RECOMMENDED CIRCUIT FIGURE 1-②)

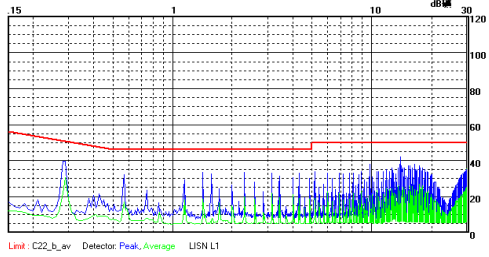

URB2405YMD-6WR2 CE (Class B, Positive line)

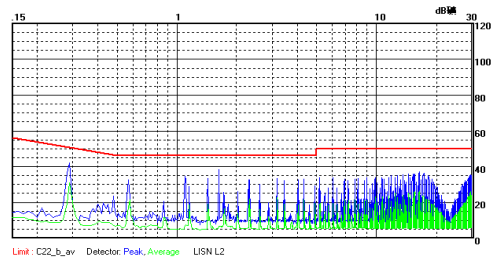

URB2405YMD-6WR2 CE (Class B, Negative line)

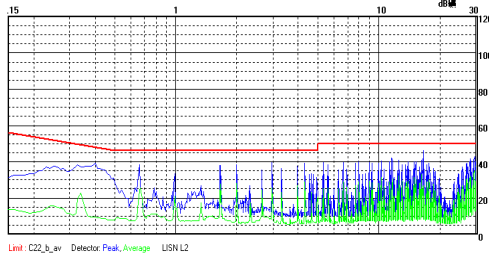

URA4805YMD-6WR2 CE (Class B, Positive line)

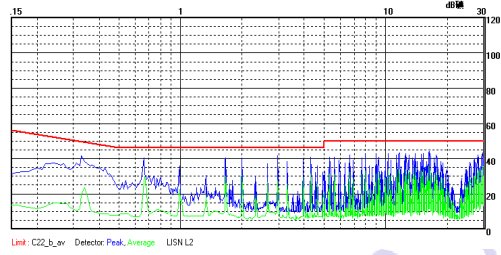

URA4805YMD-6WR2 CE (Class B, Negative line)

PRODUCT TYPICAL PERFORMANCE CURVE

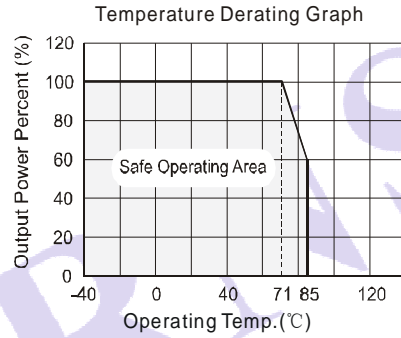

(Figure 4)

Efficiency VS Input Voltage curve (Full Load)

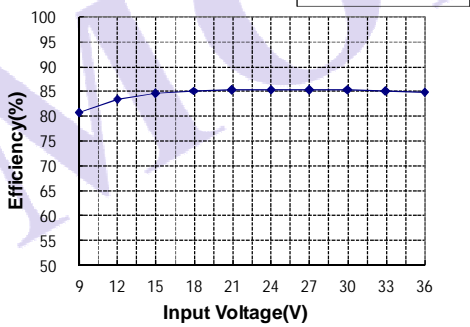

Efficiency VS Output Load curve (Vin=Vin-nominal)

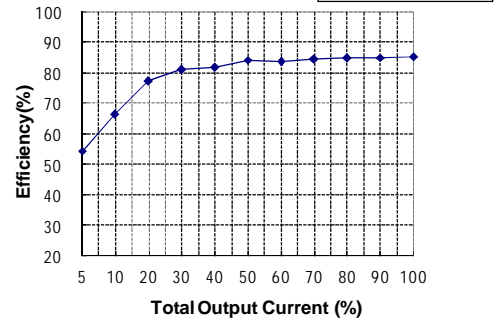

Efficiency VS Input Voltage curve (Full Load)

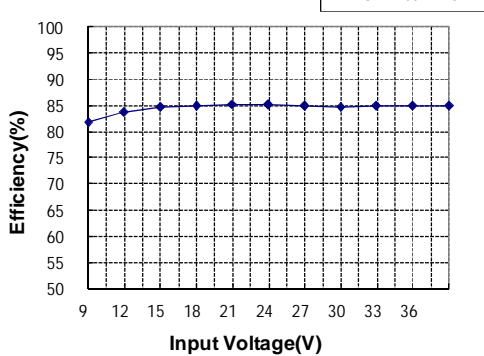

Efficiency VS Output Load curve (Vin=Vin-nominal)

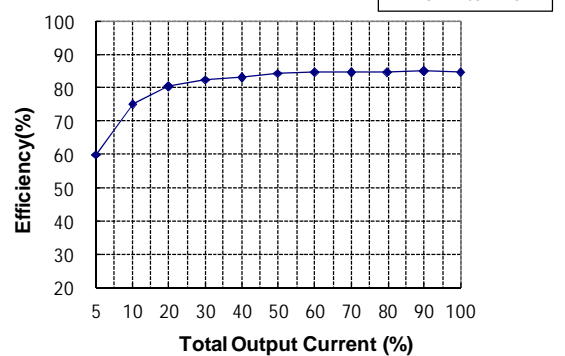

URA_YMD-6WR2& URB_YMD-6WR2 PCB MOUNTING OUTLINE DIMENSIONS,RECOMMENDED FOOTPRINT

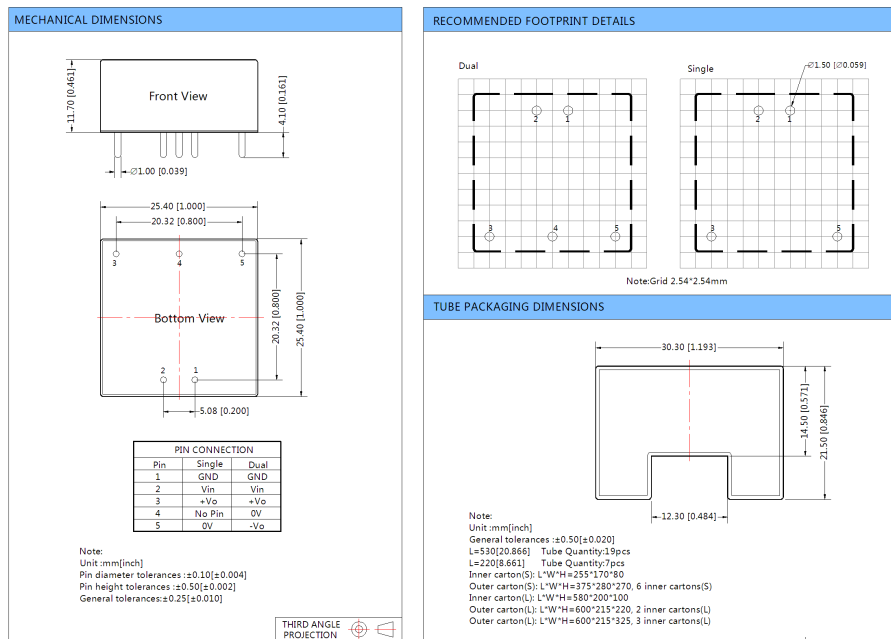

URA_YMD-6WR2A2S& URB_YMD-6WR2A2S CHASSIS MOUNTING OUTLINE DIMENSIONS



Footprint Details						
Pin	1	2	3	4	5	6
Dual	NC	GND	Vin	-Vo	OV	+Vo
Single	NC	GND	Vin	OV	NC	+Vo

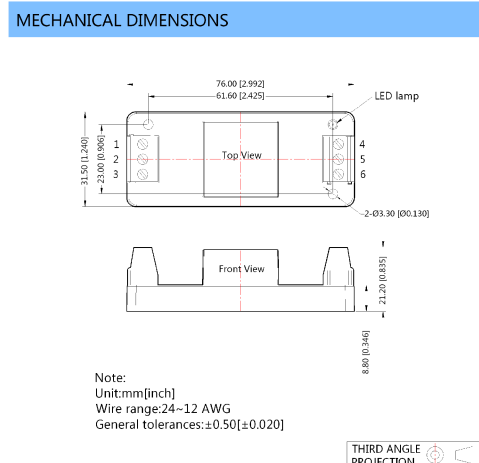

URA_YMD-6WR2A4S& URB_YMD-6WR2A4S DIN-RAIL MOUNTING OUTLINE DIMENSIONS



DIN-rail modules are fitting to TS35 rails

Footprint Details						
Pin	1	2	3	4	5	6
Dual	NC	GND	Vin	-Vo	OV	+Vo
Single	NC	GND	Vin	OV	NC	+Vo

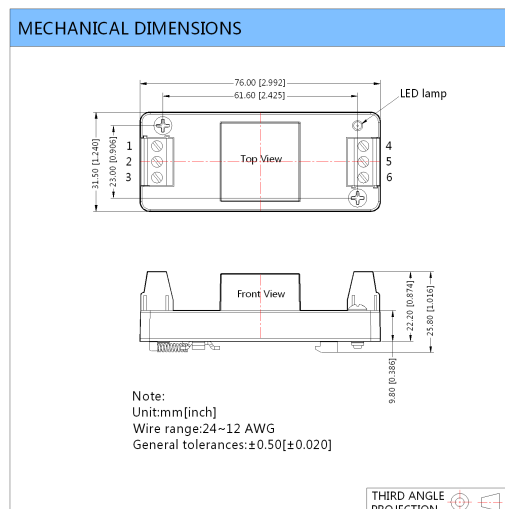

PACKAGE DIAGRAM

The copyright and authority for the interpretation of the products are reserved by MORNSUN

Special Package Series (A2S/A4S)

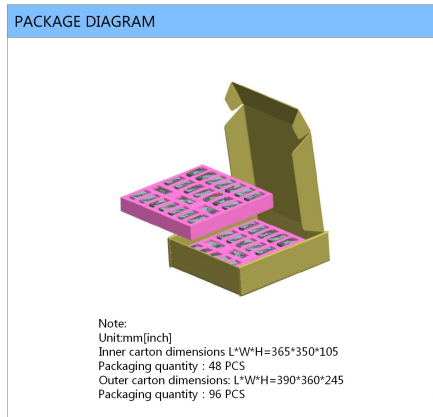

TEST CONFIGURATIONS

Input Reflected-Ripple Current Test Setup

Input reflected-ripple current is measured with an inductor L_{in} and Capacitor C_{in} to simulate the source impedance.

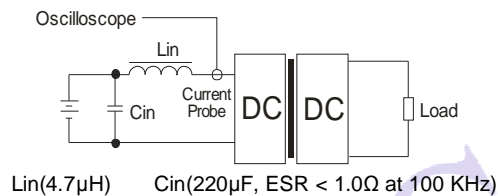

DESIGN CONSIDERATIONS

1) Recommended circuit

All the URA_YMD-6WR2 & URB_YMD-6WR2 Series have been tested according to the following recommended test circuit before leaving the factory (see Figure 5).

If you want to further decrease the input/output ripple, you can increase a capacitance-values properly or choose capacitors with low ESR, but the total capacitance of the filter capacitor must not exceed the Max. Capacitive Load.

C_{in} : 100 μ F (V_{in} nom=24V)

C_{in} : 10 μ F~47 μ F (V_{in} nom=48V)

C_{out} : 10 μ F

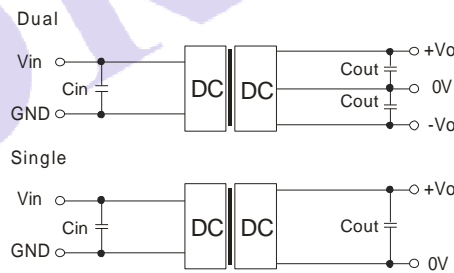

(Figure 5)

2) It is not recommended to increase the output power capability by connecting two or more converters in parallel. The product is not hot-swappable

Note:

1. Min. load shouldn't be less than 5%, otherwise ripple maybe increased dramatically, If the product operates under min. load, it may not be guaranteed to meet all specifications listed. Operation under minimum load will not damage the converter.
2. Recommended Dual output models unbalanced load is $\leq \pm 5\%$, If the product operates $> \pm 5\%$, it may not be guaranteed to meet all specifications listed. Please contact our technical support for more details.
3. Max. Capacitive Load is tested at input voltage range and full load.
4. All specifications measured at $T_a=25^\circ\text{C}$, humidity<75%, nominal input voltage and rated output load unless otherwise specified.
5. In this datasheet, all test methods are based on our corporate standards.
6. All characteristics are for listed models, and non-standard models may perform differently. Please contact our technical support for more details.
7. Please contact our technical support for any specific requirement.
8. Specifications of this product are subject to changes without prior notice.

MORNSUN Science & Technology Co.,Ltd.

Address: No. 5, Kehui St. 1, Kehui development center, Science Ave., Guangzhou Science City, Luogang district, Guangzhou,P.R.China.

Tel: 86-20-38601850

Fax:86-20-38601272

E-mail: info@mornsun.cn

[Http://www.mornsun-power.com](http://www.mornsun-power.com)