

N- AND P-Channel Logic Level Enhancement Mode MOSFET

MTBA6C15Q8

	N-CH	P-CH
BV_{DSS}	150V	-150V
$I_D @ T_A=25^{\circ}C, V_{GS}=10V(-10V)$	1.8A	-1.5A
$I_D @ T_A=70^{\circ}C, V_{GS}=10V(-10V)$	1.5A	-1.3A
$I_D @ T_C=25^{\circ}C, V_{GS}=10V(-10V)$	3.2A	-2.6A
$I_D @ T_C=100^{\circ}C, V_{GS}=10V(-10V)$	2.3A	-1.8A
$R_{DSON}(typ.) @ V_{GS}=(-)10V$	169 mΩ	259 mΩ
$R_{DSON}(typ.) @ V_{GS}=(-)4.5V$	176 mΩ	277 mΩ

Features

- Simple drive requirement
- Low on-resistance
- Fast switching speed
- Pb-free lead plating and halogen-free package

Equivalent Circuit

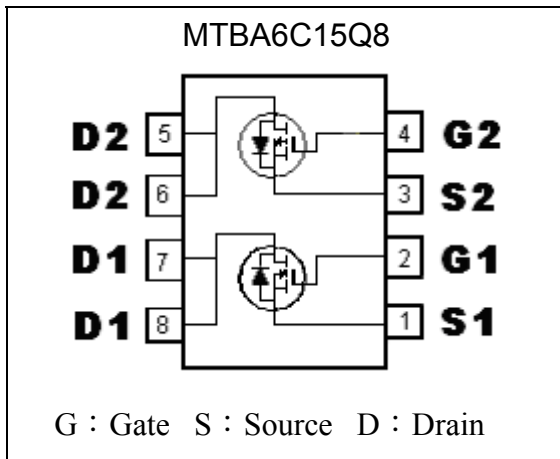

Outline

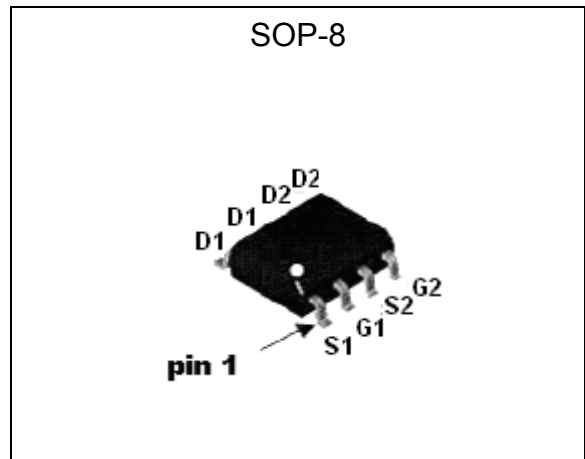

Ordering Information

Device	Package	Shipping
MTBA6C15Q8-0-T3-G	SOP-8 (Pb-free lead plating & halogen-free package)	2500 pcs / Tape & Reel

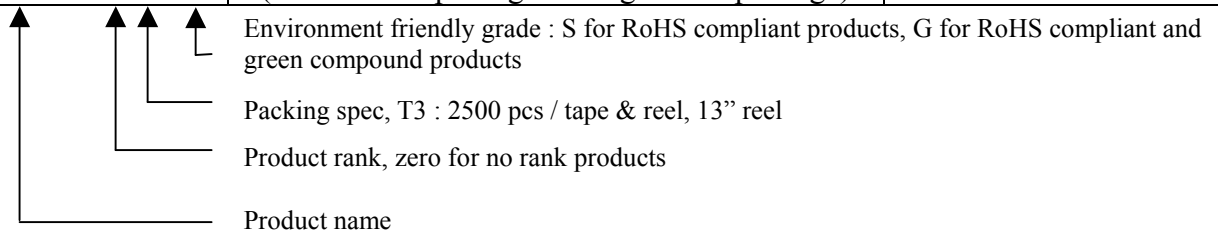



Absolute Maximum Ratings (T_C=25°C, unless otherwise noted)

Parameter	Symbol	Limits		Unit
		N-channel	P-channel	
Drain-Source Breakdown Voltage	BV _{DSS}	150	-150	V
Gate-Source Voltage	V _{GS}	±20	±20	
Continuous Drain Current	I _D	T _C =25 °C, V _{GS} =10V (-10V)	3.2	A
		T _C =100 °C, V _{GS} =10V (-10V)	2.3	
Continuous Drain Current (Note 2)	I _{DSM}	T _A =25 °C, V _{GS} =10V (-10V)	1.8	A
		T _A =70 °C, V _{GS} =10V (-10V)	1.5	
Pulsed Drain Current (Note 1)	I _{DM}	10	-8	
Power Dissipation for Dual Operation @T _C =25°C	P _D	6		W
Power Dissipation for Dual Operation @T _A =25°C	P _D SM	3		
Power Dissipation for Single Operation @T _A =25°C		1.9 (Note 2)		
		1.1 (Note 3)		
Operating Junction and Storage Temperature Range	T _j ; T _{stg}	-55~+175		°C

Thermal Data

Parameter	Symbol	Value	Unit
Thermal Resistance, Junction-to-case, max	R _{th,j-c}	25	°C/W
Thermal Resistance, Junction-to-ambient, max	R _{th,j-a}	50	
		78 (Note 2)	
		135 (Note 3)	

- Note : 1.Pulse width limited by maximum junction temperature.
 2.Surface mounted on 1 in² copper pad of FR-4 board, pulse width≤10s, single operation.
 3.Surface mounted on minimum copper pad, pulse width≤10s, single operation.

N-Channel Electrical Characteristics (T_C=25°C, unless otherwise specified)

Symbol	Min.	Typ.	Max.	Unit	Test Conditions
Static					
BV _{DSS}	150	-	-	V	V _{GS} =0V, I _D =250μA
ΔBV _{DSS} /ΔT _j	-	0.14	-	V/°C	Reference to 25°C, I _D =250μA
V _{GS(th)}	1.3	-	2.3	V	V _{DS} =V _{GS} , I _D =250μA
I _{GSS}	-	-	±100	nA	V _{GS} =±20V, V _{DS} =0V
I _{DSS}	-	-	1	μA	V _{DS} =120V, V _{GS} =0V
	-	-	10	μA	V _{DS} =120V, V _{GS} =0, T _j =55°C
*R _{DS(ON)}	-	169	230	mΩ	I _D =1.8A, V _{GS} =10V
	-	176	250		I _D =1.5A, V _{GS} =4.5V
*G _{FS}	-	7	-	S	V _{DS} =10V, I _D =1.8A
Dynamic					
C _{iss}	-	465	-	pF	V _{DS} =25V, V _{GS} =0, f=1MHz
C _{oss}	-	45	-		
C _{rss}	-	26	-		



*td(ON)	-	6.4	-	ns	V _{DS} =75V, I _D =1A, V _{GS} =10V, R _G =6Ω
*tr	-	16.4	-		
*td(OFF)	-	59.6	-		
*tf	-	60	-		
*Q _g	-	13.4	-	nC	V _{DS} =120V, I _D =1.8A, V _{GS} =10V
*Q _{gs}	-	1.6	-		
*Q _{gd}	-	3.5	-		
Body Diode					
*I _S	-	-	1.8	A	
*I _{SM}	-	-	10		
*V _{SD}	-	0.79	1.3	V	V _{GS} =0V, I _S =1.8A
trr *	-	28	-	ns	I _F =1.8A, dI _F /dt=100A/μs
Q _{rr} *	-	37	-	nC	

P-Channel Electrical Characteristics (T_c=25°C, unless otherwise specified)

Symbol	Min.	Typ.	Max.	Unit	Test Conditions
Static					
BV _{DSS}	-150	-	-	V	V _{GS} =0V, I _D =-250μA
ΔBV _{DSS} /ΔT _j	-	-0.12	-	V/°C	Reference to 25°C, I _D =-250μA
V _{GS(th)}	-1.3	-	-2.3	V	V _{DS} =V _{GS} , I _D =-250μA
I _{GSS}	-	-	±100	nA	V _{GS} =±20V, V _{DS} =0V
I _{DSS}	-	-	-1	μA	V _{DS} =-120V, V _{GS} =0V
	-	-	-10		V _{DS} =-120V, V _{GS} =0, T _j =55°C
*R _{Ds(ON)}	-	259	340	mΩ	I _D =-1.5A, V _{GS} =-10V
	-	277	370		I _D =-1A, V _{GS} =-4.5V
*G _{FS}	-	5.8	-	S	V _{DS} =-10V, I _D =-1.5A
Dynamic					
C _{iss}	-	1053	-	pF	V _{DS} =-25V, V _{GS} =0, f=1MHz
C _{oss}	-	67	-		
C _{rss}	-	36	-		
*td(ON)	-	9	-	ns	V _{DS} =-75V, I _D =-1A, V _{GS} =-10V, R _G =6Ω
*tr	-	17.6	-		
*td(OFF)	-	55.4	-		
*tf	-	544	-		
*Q _g	-	25	-	nC	V _{DS} =-120V, I _D =-1.5A, V _{GS} =-10V
*Q _{gs}	-	3	-		
*Q _{gd}	-	6.3	-		
Body Diode					
*I _S	-	-	-1.5	A	
*I _{SM}	-	-	-8		
*V _{SD}	-	-0.76	-1.3	V	V _{GS} =0V, I _S =-1.5A
trr *	-	29	-	ns	I _F =1.5A, dI _F /dt=100A/μs
Q _{rr} *	-	36	-	nC	

*Pulse Test : Pulse Width ≤300μs, Duty Cycle ≤2%

Typical Characteristics : Q1(N-channel)

Typical Output Characteristics

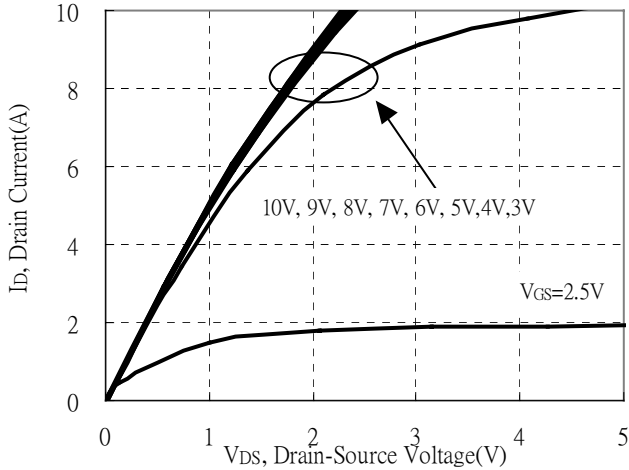

Brekdown Voltage vs Ambient Temperature

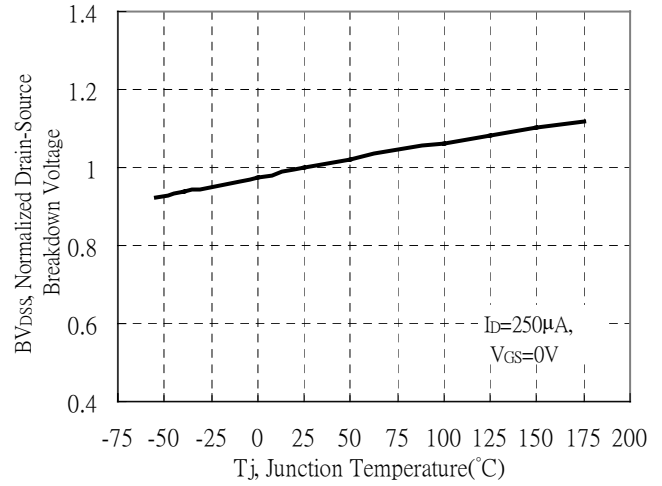

Static Drain-Source On-State resistance vs Drain Current

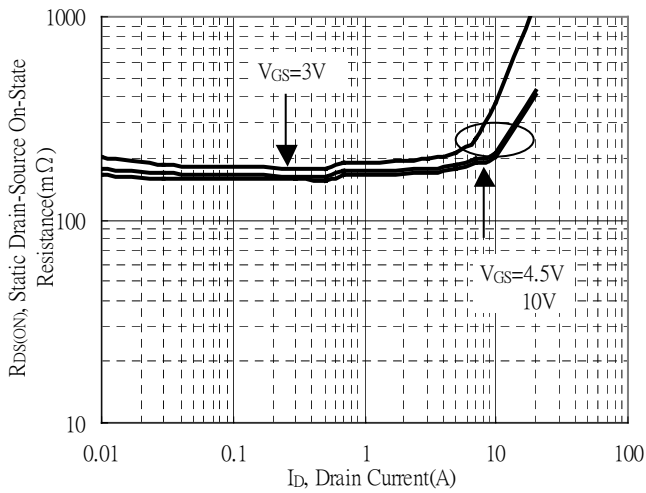

Reverse Drain Current vs Source-Drain Voltage

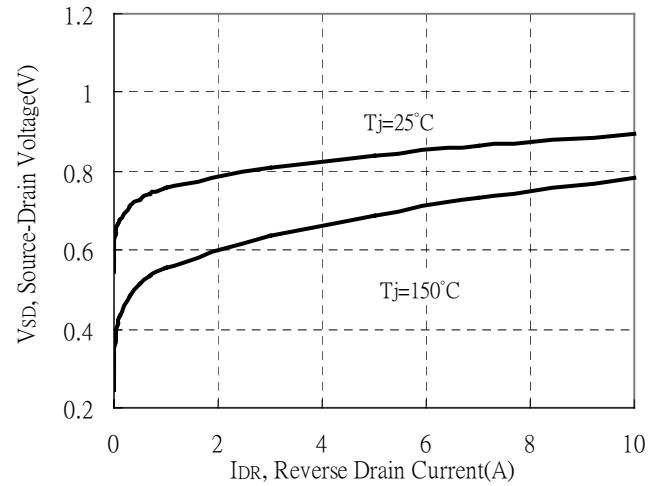

Static Drain-Source On-State Resistance vs Gate-Source Voltage

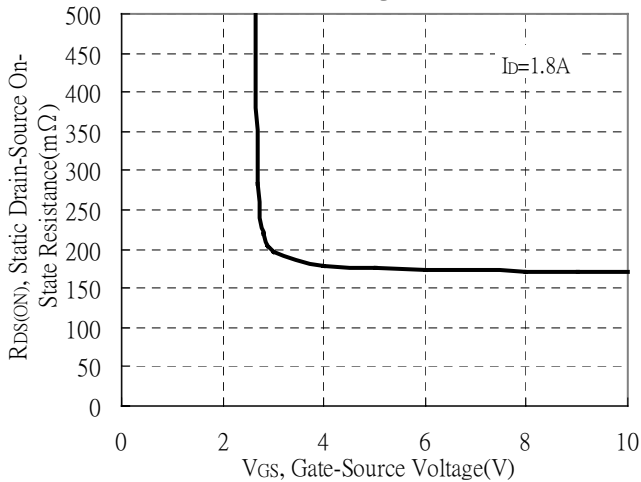

Drain-Source On-State Resistance vs Junction Temperature

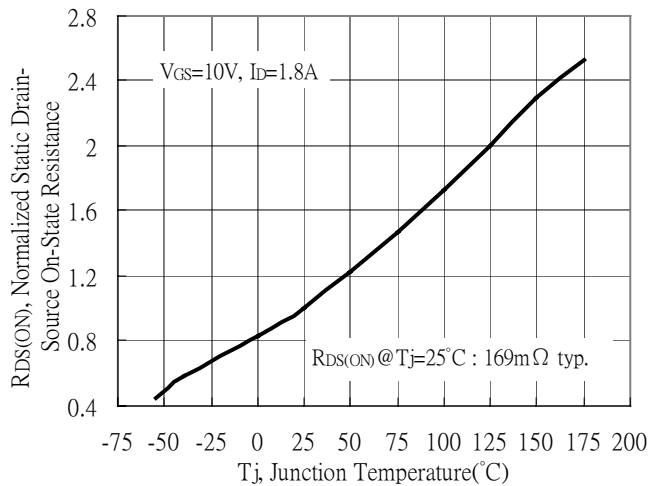

Typical Characteristics(Cont.) : Q1(N-channel)

Capacitance vs Drain-to-Source Voltage

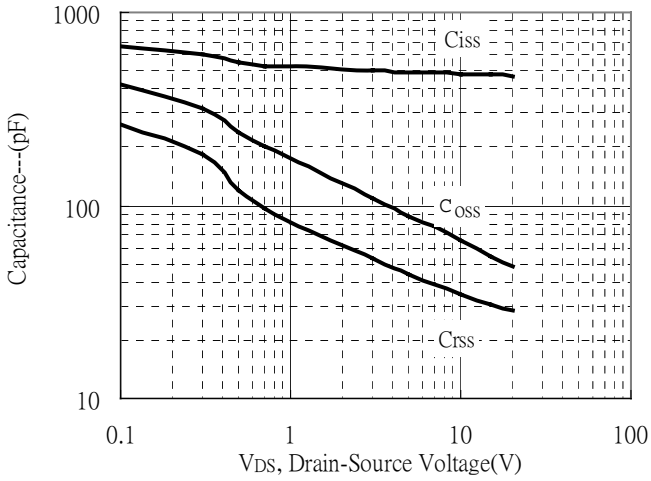

Threshold Voltage vs Junction Temperature

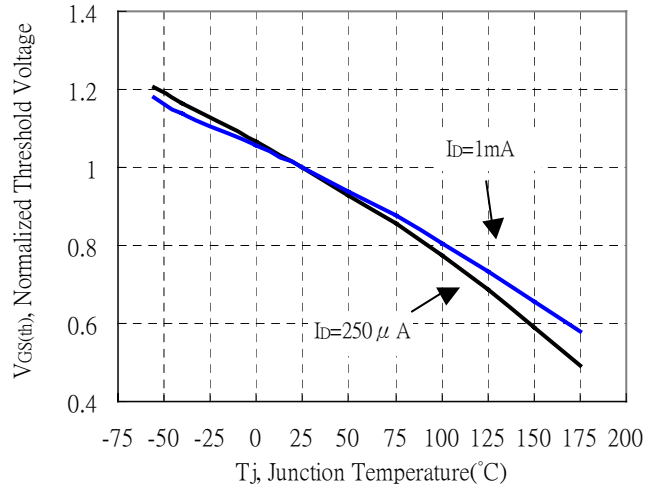

Forward Transfer Admittance vs Drain Current

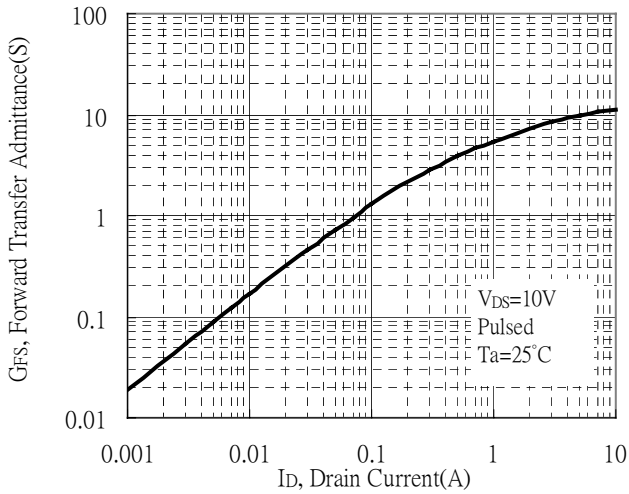

Gate Charge Characteristics

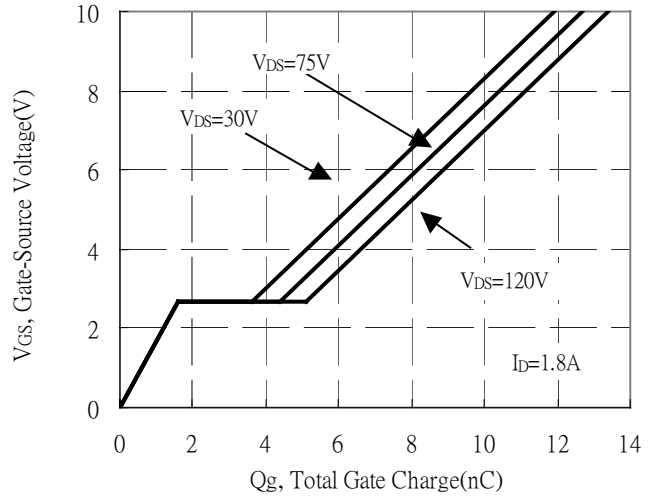

Maximum Safe Operating Area

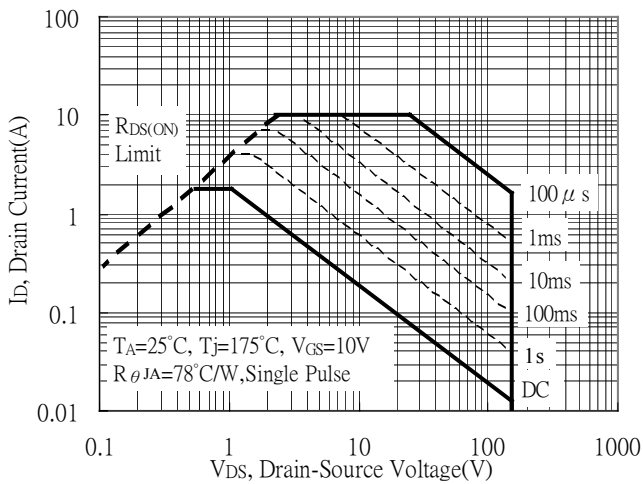

Maximum Drain Current vs Junction Temperature

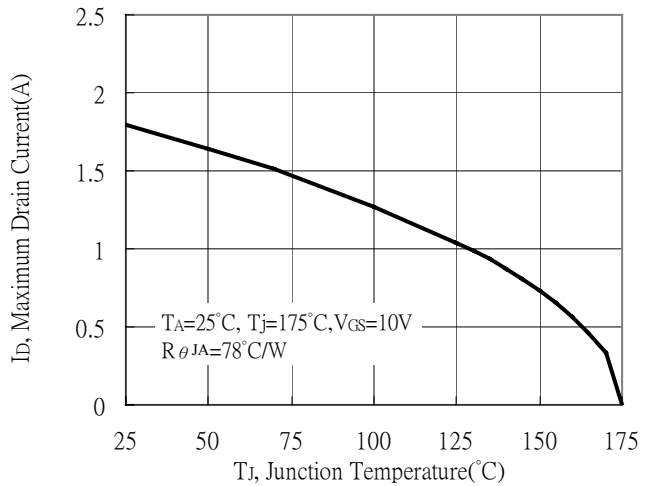



Typical Characteristics(Cont.) : Q1(N-channel)

Single Pulse Power Rating, Junction to Ambient
(Note on page 2)

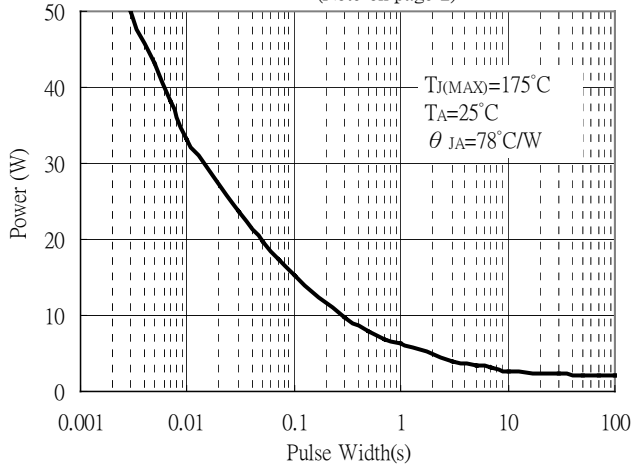

Transient Thermal Response Curves

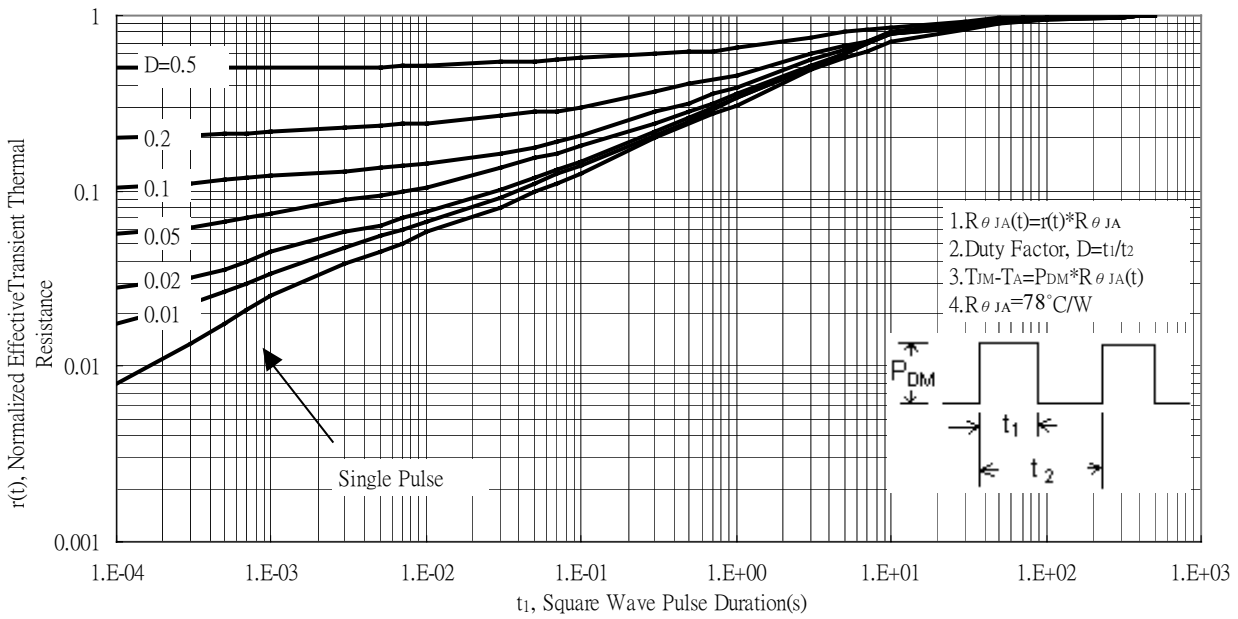



Typical Characteristics : Q2(P-channel)

Typical Output Characteristics

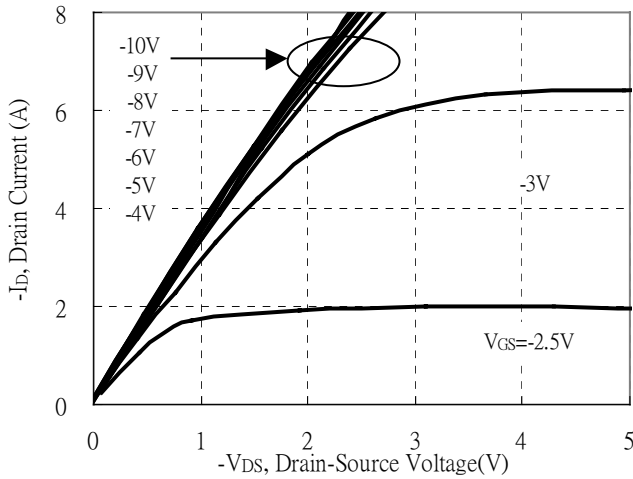

Breakdown Voltage vs Ambient Temperature

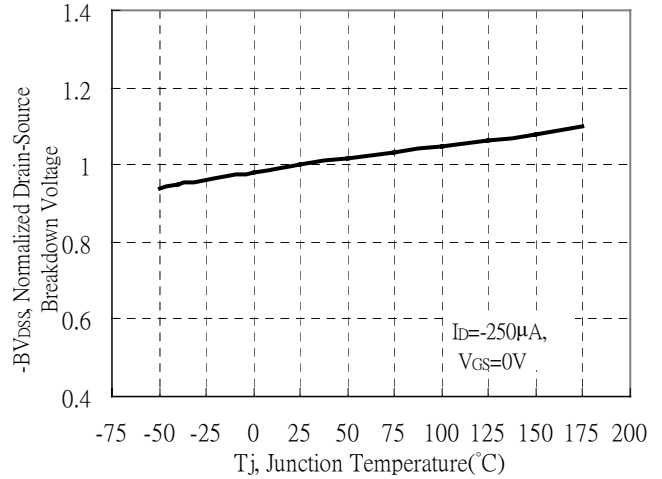

Static Drain-Source On-State resistance vs Drain Current

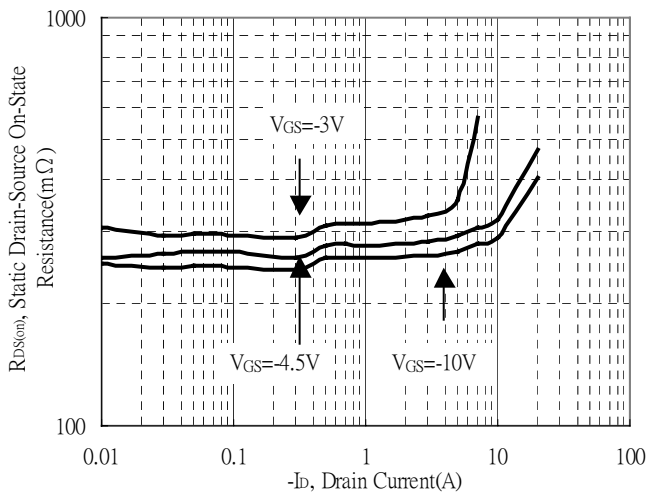

Source Drain Current vs Source-Drain Voltage

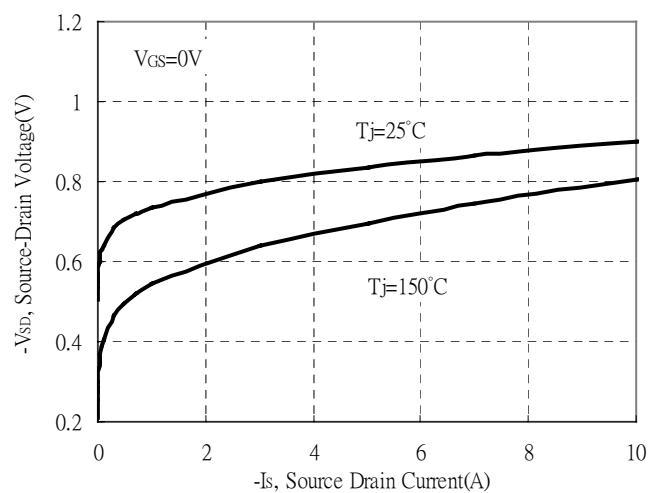

Static Drain-Source On-State Resistance vs Gate-Source Voltage

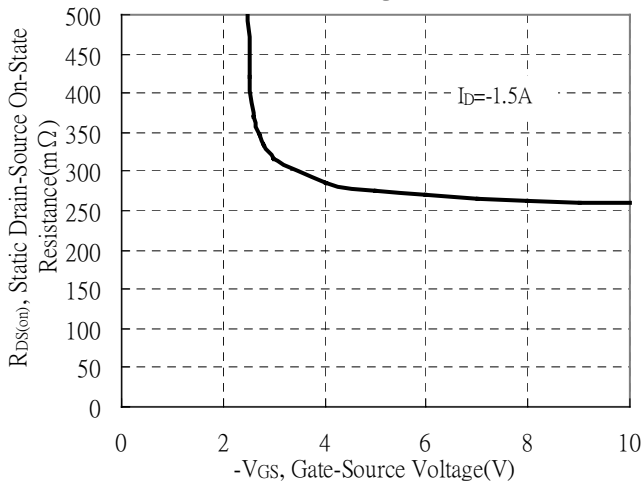

Drain-Source On-State Resistance vs Junction Temperature

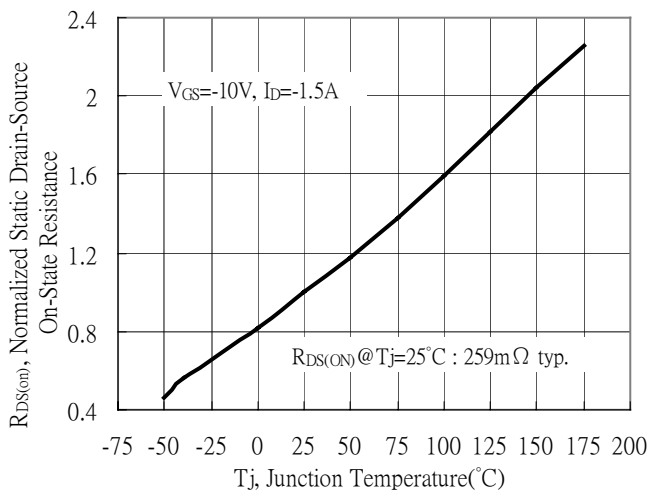

Typical Characteristics(Cont.) : Q2(P-channel)

Capacitance vs Drain-to-Source Voltage

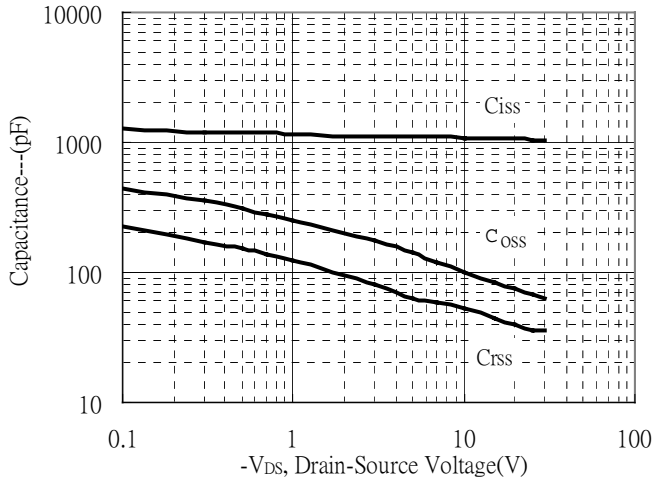

Threshold Voltage vs Junction Temperature

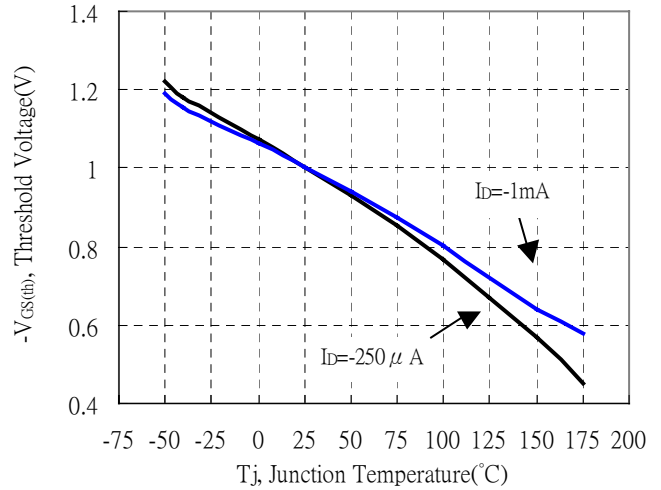

Forward Transfer Admittance vs Drain Current

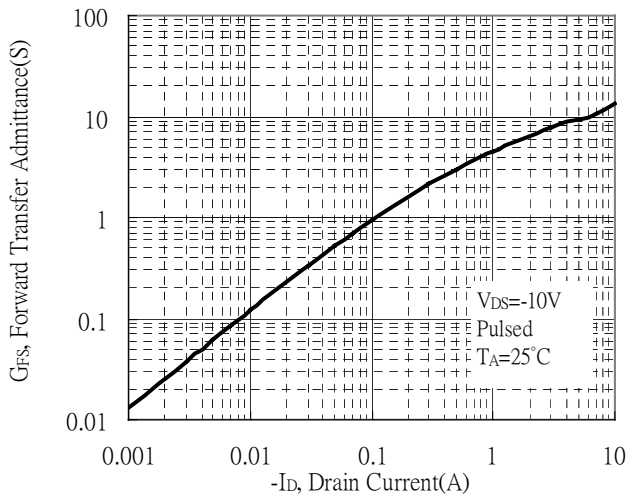

Gate Charge Characteristics

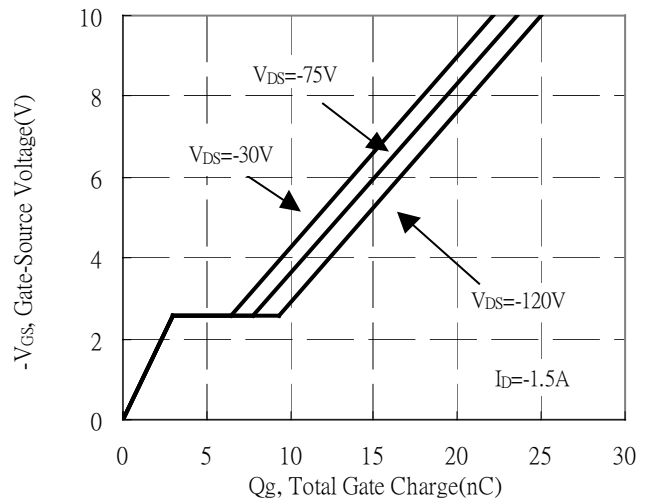

Maximum Safe Operating Area

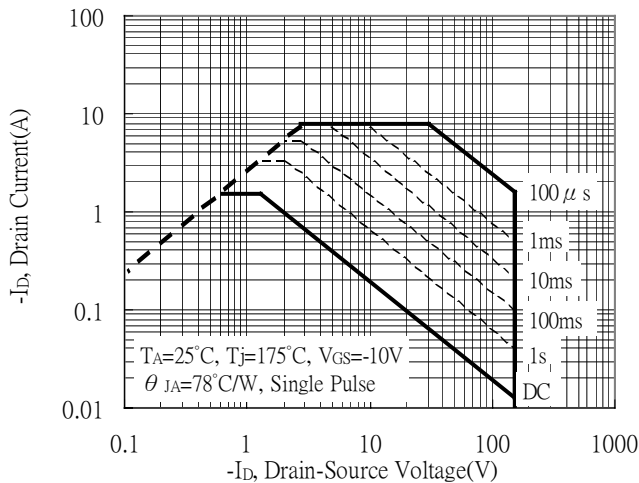

Maximum Drain Current vs Junction Temperature

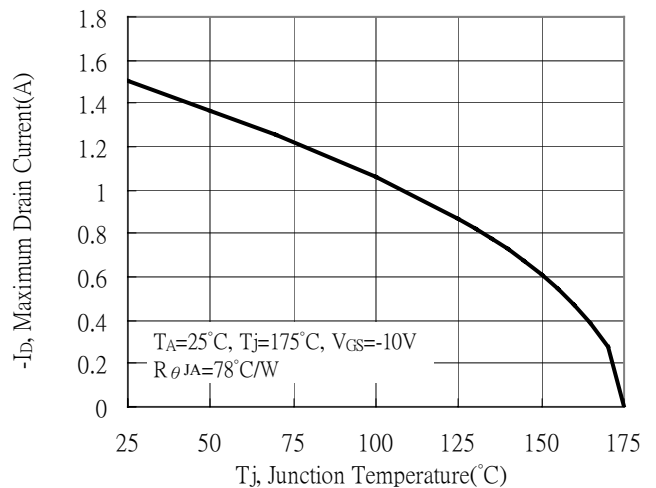

Typical Characteristics(Cont.) : Q2(P-channel)

Single Pulse Power Rating, Junction to Ambient
 (Note on page 2)

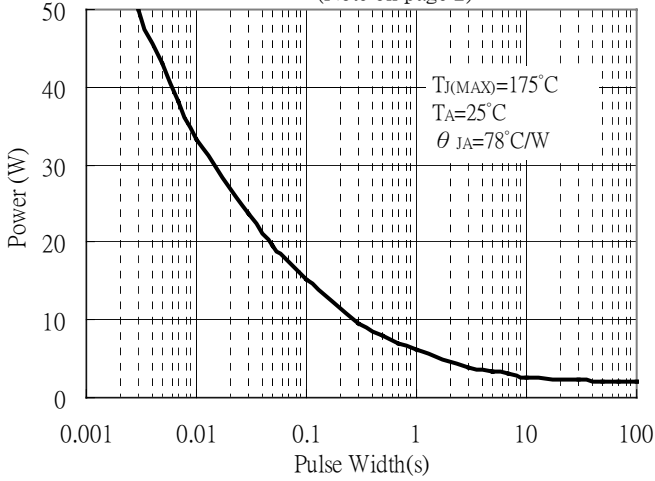

Transient Thermal Response Curves

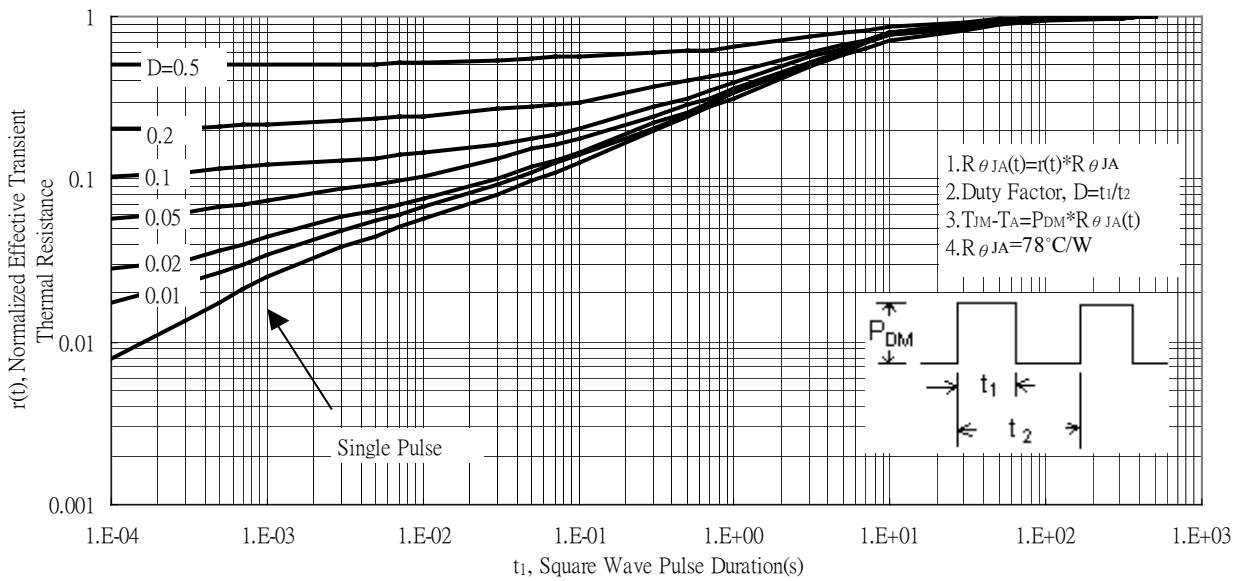

Recommended Soldering Footprint

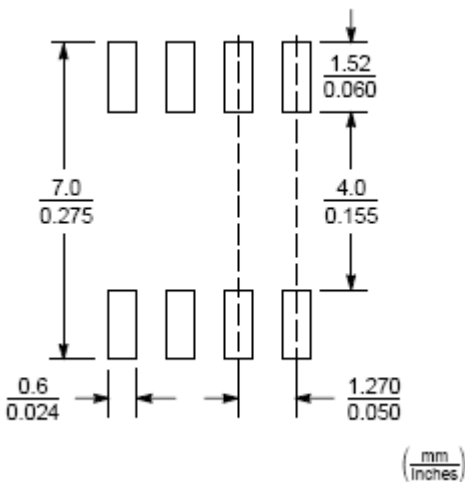

Reel Dimension

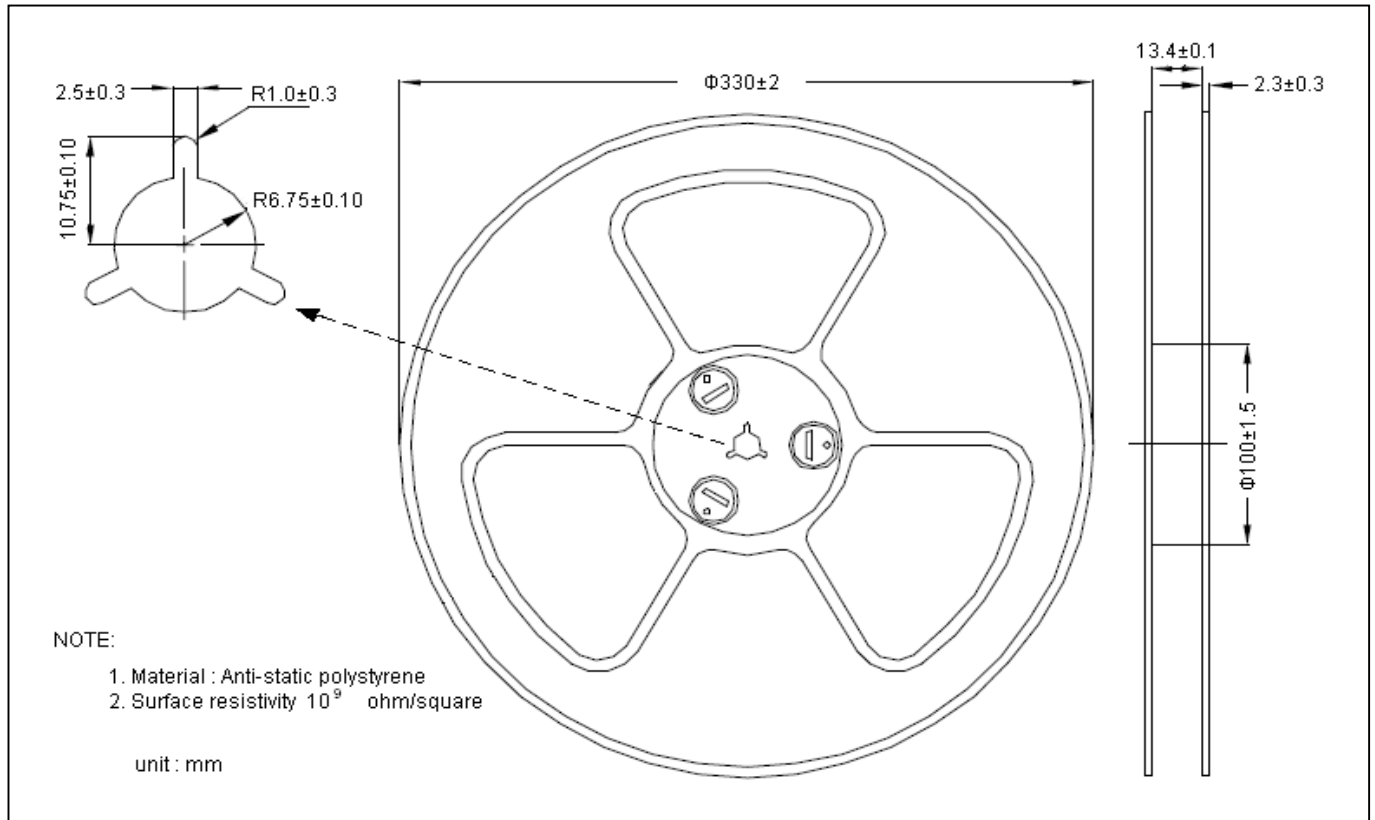

Carrier Tape Dimension

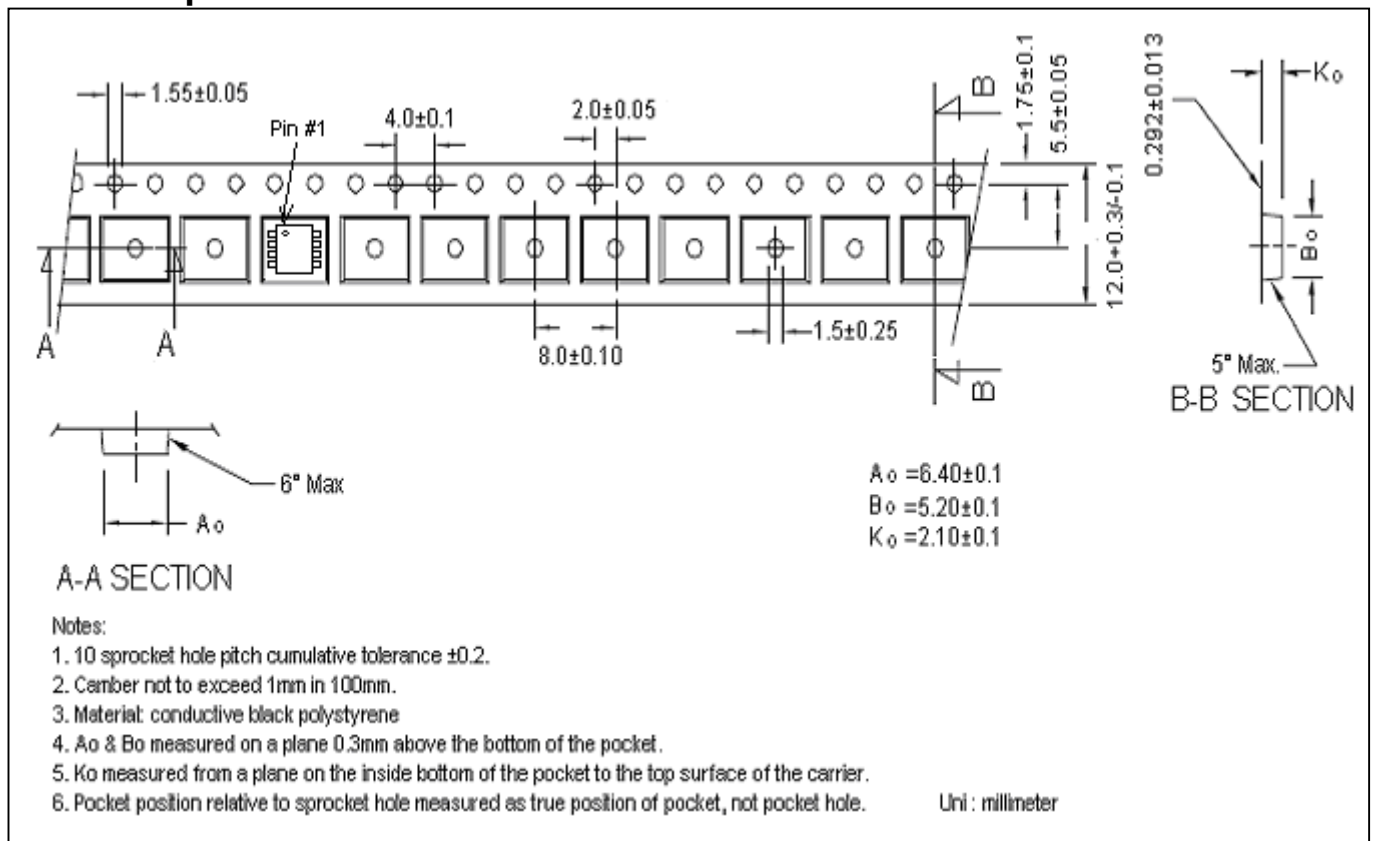

Recommended wave soldering condition

Product	Peak Temperature	Soldering Time
Pb-free devices	260 +0/-5 °C	5 +1/-1 seconds

Recommended temperature profile for IR reflow

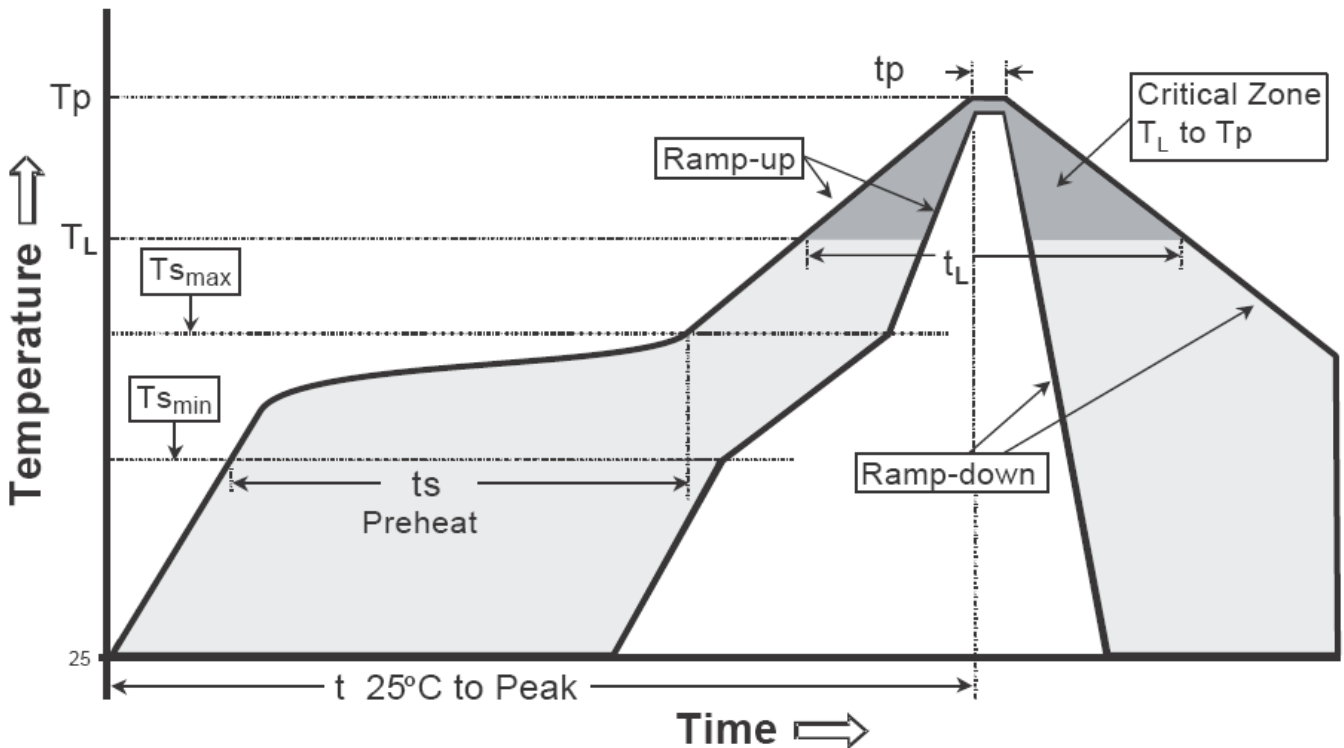

Profile feature	Sn-Pb eutectic Assembly	Pb-free Assembly
Average ramp-up rate (Tsmax to Tp)	3°C/second max.	3°C/second max.
Preheat		
-Temperature Min(Ts min)	100°C	150°C
-Temperature Max(Ts max)	150°C	200°C
-Time(ts min to ts max)	60-120 seconds	60-180 seconds
Time maintained above:		
-Temperature (TL)	183°C	217°C
- Time (tL)	60-150 seconds	60-150 seconds
Peak Temperature(TP)	240 +0/-5 °C	260 +0/-5 °C
Time within 5°C of actual peak temperature(tp)	10-30 seconds	20-40 seconds
Ramp down rate	6°C/second max.	6°C/second max.
Time 25 °C to peak temperature	6 minutes max.	8 minutes max.

Note : All temperatures refer to topside of the package, measured on the package body surface.

SOP-8 Dimension

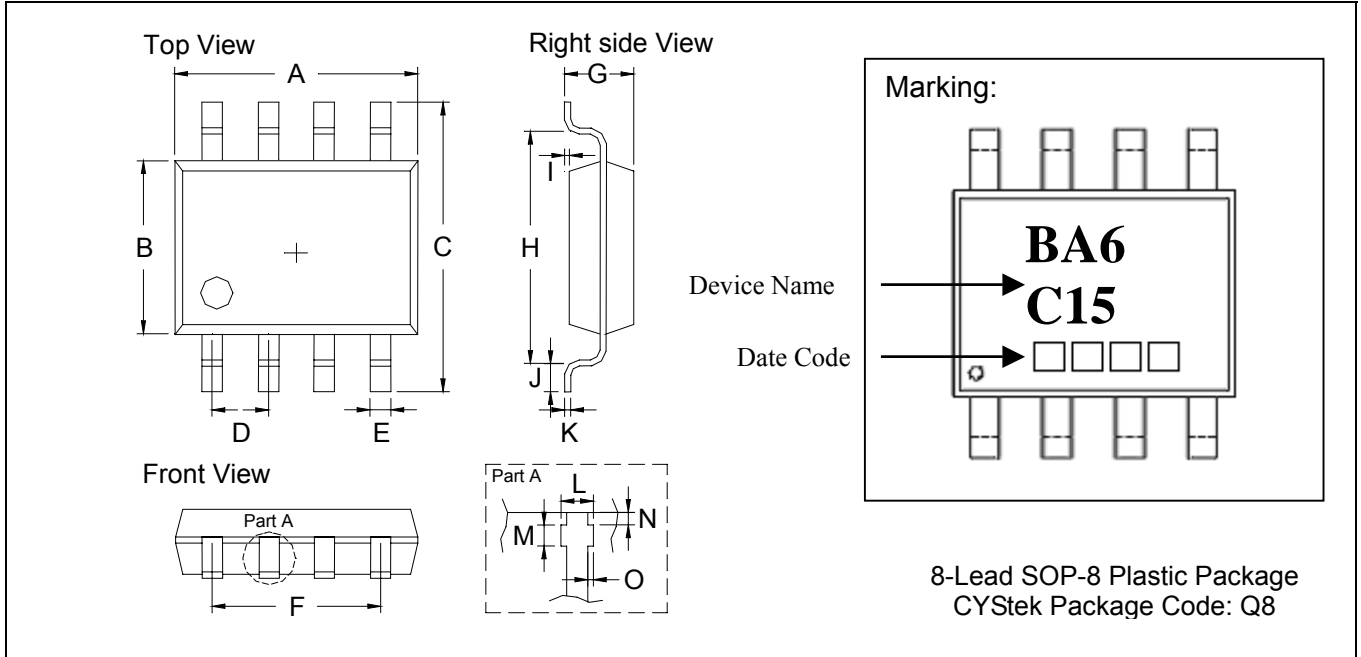

*: Typical

DIM	Inches		Millimeters		DIM	Inches		Millimeters	
	Min.	Max.	Min.	Max.		Min.	Max.	Min.	Max.
A	0.1909	0.2007	4.85	5.10	I	0.0019	0.0078	0.05	0.20
B	0.1515	0.1555	3.85	3.95	J	0.0118	0.0275	0.30	0.70
C	0.2283	0.2441	5.80	6.20	K	0.0074	0.0098	0.19	0.25
D	0.0480	0.0519	1.22	1.32	L	0.0145	0.0204	0.37	0.52
E	0.0145	0.0185	0.37	0.47	M	0.0118	0.0197	0.30	0.50
F	0.1472	0.1527	3.74	3.88	N	0.0031	0.0051	0.08	0.13
G	0.0570	0.0649	1.45	1.65	O	0.0000	0.0059	0.00	0.15
H	0.1889	0.2007	4.80	5.10					

Notes: 1. Controlling dimension: millimeters.
 2. Maximum lead thickness includes lead finish thickness, and minimum lead thickness is the minimum thickness of base material.
 3. If there is any question with packing specification or packing method, please contact your local CYStek sales office.

Material:

- Lead: Pure tin plated.
- Mold Compound: Epoxy resin family, flammability solid burning class: UL94V-0.

Important Notice:

- All rights are reserved. Reproduction in whole or in part is prohibited without the prior written approval of CYStek.
- CYStek reserves the right to make changes to its products without notice.
- CYStek **semiconductor products are not warranted to be suitable for use in Life-Support Applications, or systems.**
- CYStek assumes no liability for any consequence of customer product design, infringement of patents, or application assistance.