

AN7109S

2-channel Recording/Playback Pre-/Power Amplifier IC for Headphone Stereo

Overview

The AN7109S is a single chip IC integrating rec./playback/power amp. so far constituted by 3 ICs. And this IC allows low-end and process simplification of a switching, etc.

Features

- Available for head fixed type auto reverse deck
- AGC circuit built-in
- Amp. switching built-in
- Rec./playback power amp. 2ch built-in
- With radio input pin

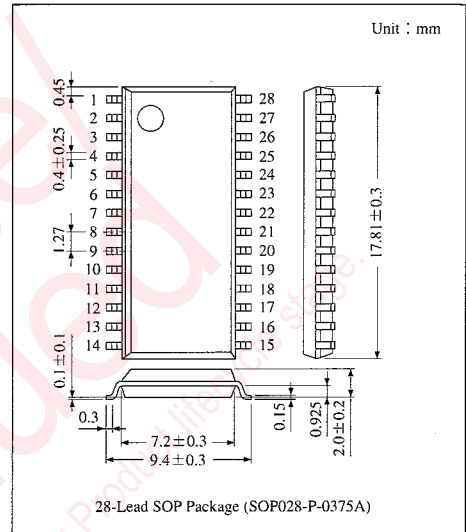

Block Diagram

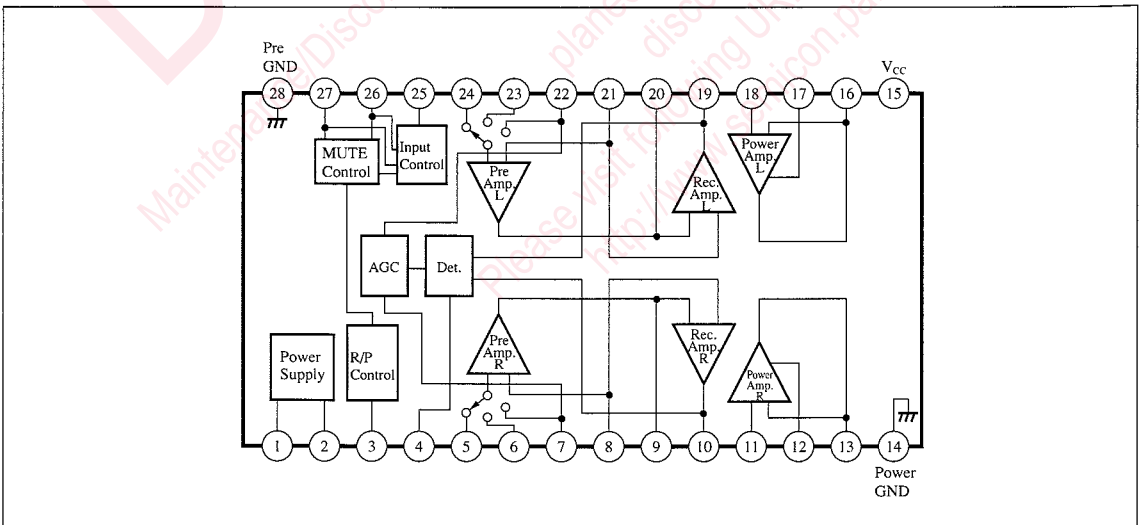

■ Absolute Maximum Ratings (Ta=25°C)

Parameter	Symbol	Rating	Unit
Supply Voltage	V _{CC}	6	V
Supply Current	I _{CC}	200	mA
Power Dissipation	P _D	562	mW
Operating Ambient Temperature	T _{opr}	-20 ~ +75	°C
Storage Temperature	T _{stg}	-55 ~ +125	°C

■ Recommended Operating Range (Ta=25°C)

Parameter	Symbol	Range
Operating Supply Voltage Range	V _{CC}	1.8V ~ 4.5V

■ Electrical Characteristics (V_{CC}=3V, f=1kHz, Ta=25°C)

Parameter	Symbol	Condition	min.	typ.	max.	Unit
Supply Current at No Signal	I _{CQ}	V _{in} =0mV, H ₁ Input, Play	6	15	25	mA

<Pre. Amp. Section>

H ₁ , H ₂ Closed Circuit Gain	G _{V1}	V _{in} =-60dBV, R _L =10kΩ	29	31	33	dB
Tu Closed Circuit Gain	G _{V2}	V _{in} =2mVrms, R _L =10kΩ	18	20	22	dB
Output Voltage	V _{op}	THD=3%, R _L =10kΩ, H ₁ Input	300	430	—	mVrms
H ₁ , H ₂ Noise Voltage Referred to Input	V _{ni}	DIN/AUDIO Filter, R _g =2.2kΩ, H ₁ Input	—	1	2	μVrms
Total Harmonic Distortion	THD ₁	H ₁ Input V _O =-20dBV, R _L =10kΩ	—	0.04	1	%

<Pre. Amp. Section>

Closed Circuit Gain	G _{Vr}	Tu Input V _{in} =3.5mVrms, R _L =10kΩ	45.5	49	52.5	dB
Output Voltage	V _{OR}	Tu Input THD=3%, R _L =10kΩ	0.8	1.05	—	Vrms
Total Harmonic Distortion	THDR	Tu Input V _{in} =3.5mVrms, R _L =10kΩ	—	0.2	1	%
Output Noise Voltage	V _{nR}	Tu Input R _g =0Ω, DIN/AUDIO, R _L =10kΩ	—	-69	-60	dBV

<AGC Section>

Effective Width	W	Effective time ~ THD=3%	35	40	—	dBV
Effective Voltage	V _S	Tu Input = 13mV	0.43	0.57	0.76	Vrms

<Power Amp. Section>

Closed Circuit Gain	G _{Vpo}	V _O =-15dBV, R _L =32Ω	33	35	37	dB
Output Voltage	V _{Opo}	THD=10%, R _L =32Ω	0.75	1	—	Vrms
Total Harmonic Distortion	THD _{po}	V _O =0.2V, R _L =32Ω	—	0.2	1	%
Output Noise Voltage	V _{npo}	R _g =0Ω, R _L =32Ω, DIN/AUDIO	—	-80	-70	dBV

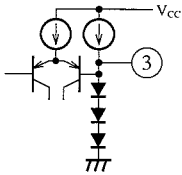
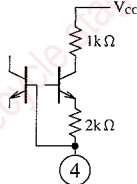
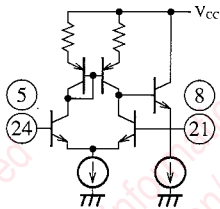
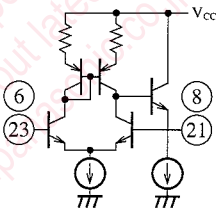
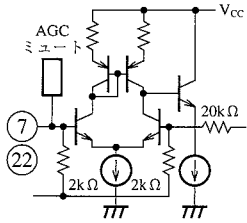
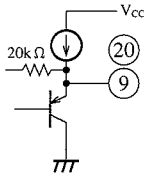

Pin Descriptions

Pin No.	Pin Name	Pin Description	Pin Voltage	Equivalent Circuit
1	Filter	—————	2.6V	—————
2	V _{REF}	—————	2.7V	—————
3	REC./PB Cont.	REC/PB switching OPEN at 2.1V in REC mode GND at 4.7kΩ 0.1V in PB mode	2.1V	
4	AGC	AGC filter connection pin. Connect the RC filter between the GND. The attack time is determined by the internal 2kΩ resistor and the externally connected C, and the recovery time is determined by the externally connected RC.	0.9V	
5 24	R-ch. H ₁ Input L-ch. H ₂ Input	H ₁ input pin	1.5V	
8 21	R-ch. PB/REC. NF Input L-ch. PB/REC. NF Input	PB (H ₁ , H ₂), REC. NF input pin		
6 23	R-ch. H ₁ Input L-ch. H ₂ Input	H ₂ input pin	1.5V	
7 22	R-ch. Tu Input L-ch. Tu Input	Tu input pin. This pin also serves as the MIC input pin. Connection of an external MIC Amp. is required as the gain is insufficient in case of direct input of the MIC signal. The gain of the Tu Amp. is 20dB.	1.5V	
9 20	R-ch. Pre-OUT L-ch. Pre-OUT	Pre-amplifier output pin. All the H ₁ input, H ₂ input, and Tu input are output from this pin.	1.5V	

ICs for
Cassette
Deck

Pin Descriptions (Cont.)

Pin No.	Pin Name	Pin Description	Pin Voltage	Equivalent Circuit
10 19	R-ch. REC. OUT L-ch. REC. OUT	<p>Rec. amp. output pin.</p> <p>The Rec Amp. input is directly connected inside, and the gain is determined by the $12k\Omega$ internal feedback resistance and the 390Ω resistor of Pin⑧. (29dB)</p> <p>The resistor of Pin⑧ is also purposed to determine the gain of the respective pre-amplifier of H_1 and H_2 So, when changing the gain, take this fact duly into account.</p>	1.5V	
11 18 12 17	R-ch. Power Input L-ch. Power Input R-ch. Phase Cont. L-ch. Phase Cont.	<p>Power Amp. input pin.</p> <p>The gain (35dB) of the power Amp. has been internally decided, and cannot be changed.</p> <p>Pin⑫ and Pin⑰ are phase compensation pins for prevention of the power amp. oscillation trouble.</p>	1.5V	
13 16	R-ch. Power OUT L-ch. Power OUT	<p>Power output pin.</p> <p>These pins are push-pull output pins, and a $3k\Omega$ resistance is respectively connected as the internal load.</p> <p>The recommended load impedance value is 32Ω.</p>	1.5V	
14	Power GND	Ground this pin near the power source because electric currents flow through the ground of the power block.	0V	
15	Vcc	Power supply pin	3V	
26	τ_2	<p>These pins are time constant setting pins for smooth switching of three pre-amplifier inputs.</p> <p>The two capacitors efficiently determine the time constants for switching control of the three input states.</p>	0.7V	
27	τ_1	<p>The charging current is a constant current of $10\mu A$. The charging current mentioned above and the $20\mu A$ discharging current are simultaneously made to flow.</p>	0.7V	

Pin Descriptions (Cont.)

Pin No.	Pin Name	Pin Description	Pin Voltage	Equivalent Circuit
25	Input Cont.	Input switching pin H ₁ Open 2V H ₂ Filter at 5.6kΩ 2.6V T _u GND at 100Ω 0.1V	2V	
28	Pre-GND	Pre-section ground	0V	—

Maintenance/Discontinued

Maintenance/Discontinued includes following four Product lifecycle stage:
 planned maintenance type
 maintenance type
 planned discontinued type
 discontinued type
 Please visit following URL about latest information.
<http://www.semicon.panasonic.co.jp/en/>

ICs for
Cassette
Deck

Request for your special attention and precautions in using the technical information and semiconductors described in this book

- (1) If any of the products or technical information described in this book is to be exported or provided to non-residents, the laws and regulations of the exporting country, especially, those with regard to security export control, must be observed.
- (2) The technical information described in this book is intended only to show the main characteristics and application circuit examples of the products. No license is granted in and to any intellectual property right or other right owned by Panasonic Corporation or any other company. Therefore, no responsibility is assumed by our company as to the infringement upon any such right owned by any other company which may arise as a result of the use of technical information described in this book.
- (3) The products described in this book are intended to be used for standard applications or general electronic equipment (such as office equipment, communications equipment, measuring instruments and household appliances).
Consult our sales staff in advance for information on the following applications:
 - Special applications (such as for airplanes, aerospace, automobiles, traffic control equipment, combustion equipment, life support systems and safety devices) in which exceptional quality and reliability are required, or if the failure or malfunction of the products may directly jeopardize life or harm the human body.
 - Any applications other than the standard applications intended.
- (4) The products and product specifications described in this book are subject to change without notice for modification and/or improvement. At the final stage of your design, purchasing, or use of the products, therefore, ask for the most up-to-date Product Standards in advance to make sure that the latest specifications satisfy your requirements.
- (5) When designing your equipment, comply with the range of absolute maximum rating and the guaranteed operating conditions (operating power supply voltage and operating environment etc.). Especially, please be careful not to exceed the range of absolute maximum rating on the transient state, such as power-on, power-off and mode-switching. Otherwise, we will not be liable for any defect which may arise later in your equipment.
 - Even when the products are used within the guaranteed values, take into the consideration of incidence of break down and failure mode, possible to occur to semiconductor products. Measures on the systems such as redundant design, arresting the spread of fire or preventing glitch are recommended in order to prevent physical injury, fire, social damages, for example, by using the products.
- (6) Comply with the instructions for use in order to prevent breakdown and characteristics change due to external factors (ESD, EOS, thermal stress and mechanical stress) at the time of handling, mounting or at customer's process. When using products for which damp-proof packing is required, satisfy the conditions, such as shelf life and the elapsed time since first opening the packages.
- (7) This book may be not reprinted or reproduced whether wholly or partially, without the prior written permission of our company.