

300mA HIGH SPEED, EXTREMELY LOW NOISE CMOS LDO REGULATOR AP2129

General Description

The AP2129 is a 300mA, positive Voltage regulator ICs fabricated by CMOS process. The AP2129 provides two kinds of output voltage operation modes for setting the output voltage. Fixed output voltage mode senses the output voltage on V_{OUT} , adjustable output voltage mode needs two resistors as a voltage divider

The AP2129 series have features of low dropout voltage, low noise, high output voltage accuracy, and low current consumption which make them ideal for use in various battery-powered devices.

AP2129 has 1.0V, 1.2V, 1.8V, 2.6V, 2.8V, 3.0V and 3.3V fixed voltage version and 0.8V to 4.5V adjustable voltage version.

The AP2129 series are available in DFN-1.5x2-6 (1.0V, 1.2V, 1.8V, 2.6V, 2.8V, 3.0V, 3.3V) and SOT-23-5 (1.0V, 1.2V, 3.3V, ADJ) packages.

Features

- Wide Operating Voltage: 1.8V to 6V
- High Output Voltage Accuracy: $\pm 2\%$
- High Ripple Rejection:
65dB@ $f=1\text{kHz}$, 45dB@ $f=10\text{kHz}$
- Low Standby Current: 0.1 μA
- Low Quiescent Current: 60 μA Typical
- Low Output Noise: 60 μV_{rms}
- Short Current Limit: 50mA
- Over Temperature Protection
- Compatible with Low ESR Ceramic Capacitor: 1 μF for C_{IN} and C_{OUT}
- Excellent Line/Load Regulation
- Soft Start Time: 50 μs
- Auto Discharge Resistance: $R_{\text{DS(ON)}}=60\Omega$

Applications

- Datacom
- Notebook Computers
- Mother Board

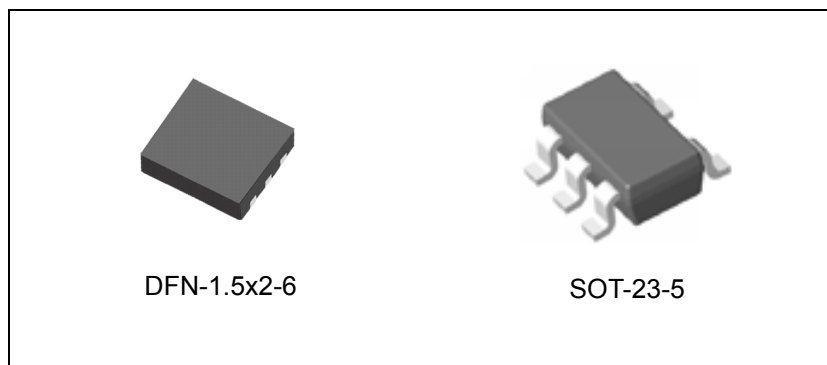

Figure 1. Package Type of AP2129

Pin Configuration

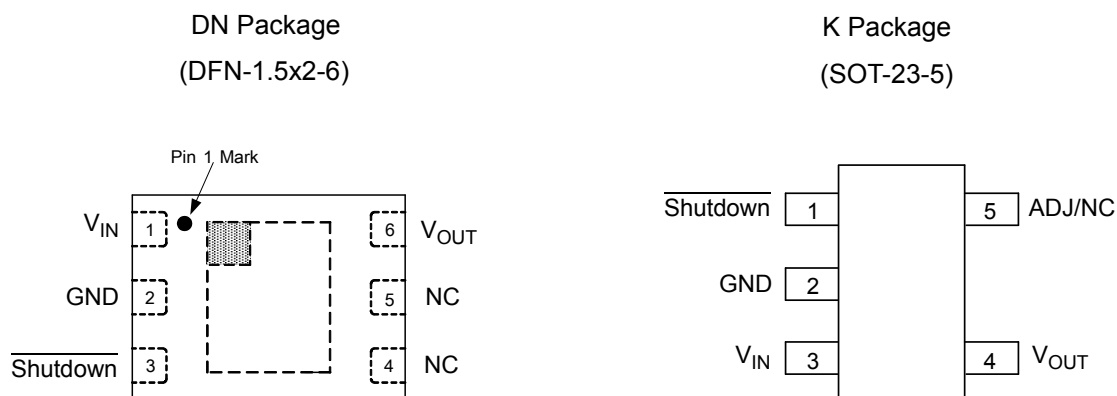

Figure 2. Pin Configuration of AP2129 (Top View)

Pin Description

Pin Number		Pin Name	Function
DFN-1.5x2-6	SOT-23-5		
1	3	V_{IN}	Input Voltage
2	2	GND	Ground
3	1	$\overline{\text{Shutdown}}$	Active High Enable Input Pin. Logic high=enable, logic low=shut-down
4, 5		NC	No Connection
	5	ADJ/NC	Adjust Output for ADJ version/No Connection for Fixed Version
6	4	V_{OUT}	Regulated Output Voltage

Functional Block Diagram

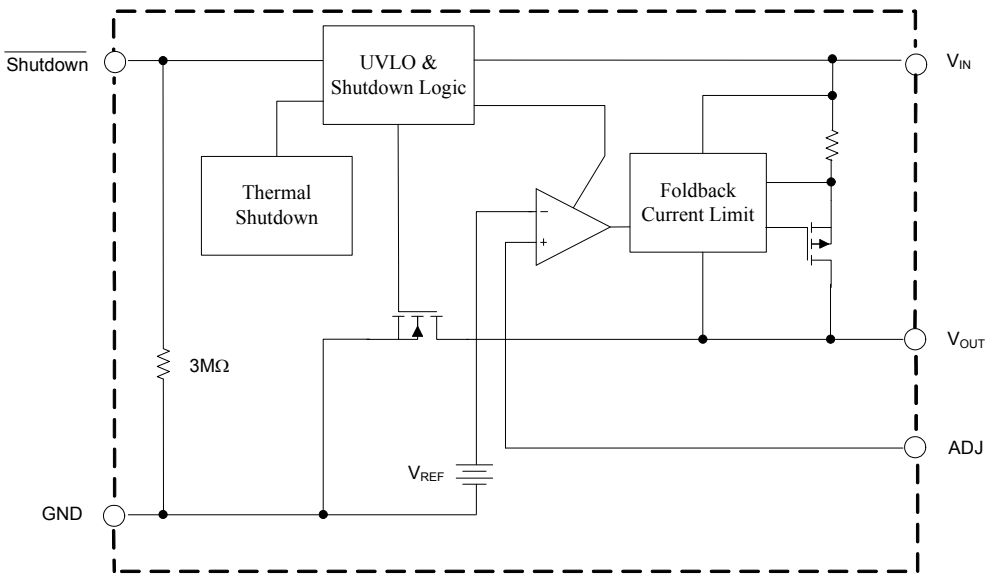
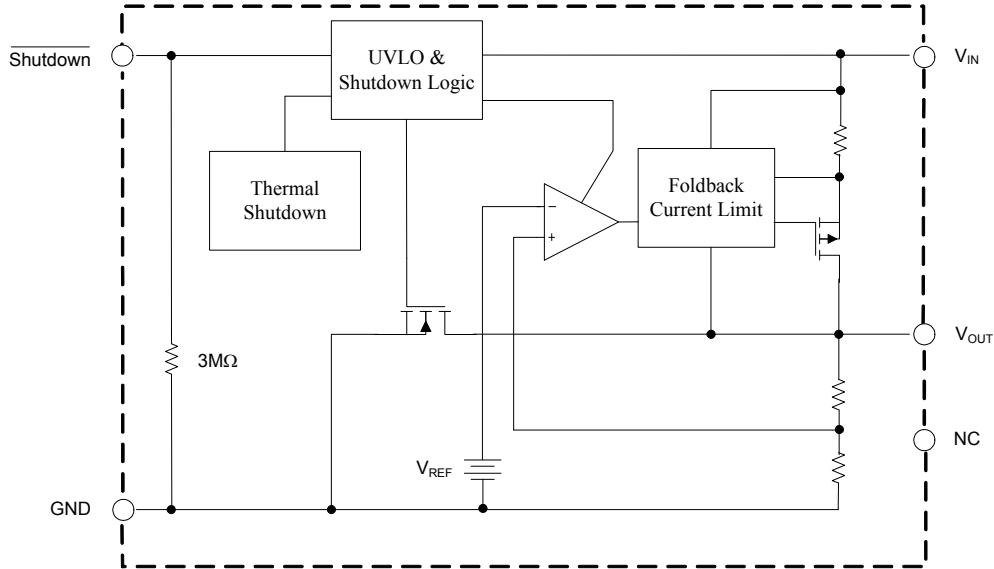
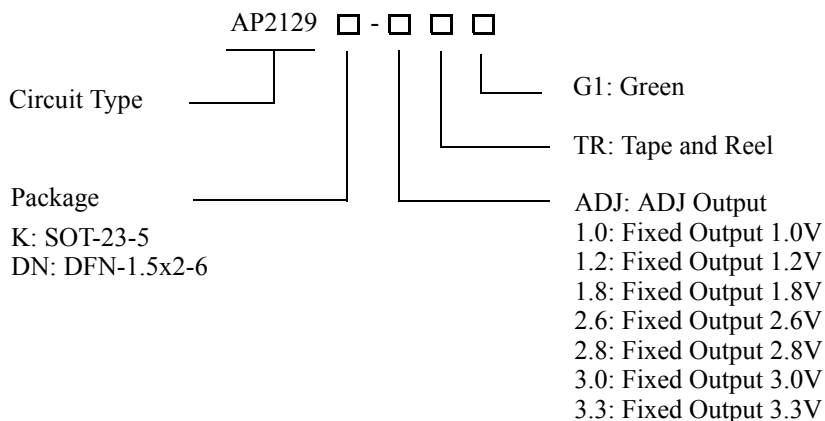

Figure 3. Functional Block Diagram of AP2129



300mA HIGH SPEED, EXTREMELY LOW NOISE CMOS LDO REGULATOR AP2129

Ordering Information



Package	Temperature Range	Part Number	Marking ID	Packing Type
SOT-23-5	-40 to 85°C	AP2129K- ADJTRG1	GEJ	Tape & Reel
		AP2129K-1.0TRG1	GEK	Tape & Reel
		AP2129K-1.2TRG1	GEL	Tape & Reel
		AP2129K-3.3TRG1	GEM	Tape & Reel
DFN-1.5x2-6	-40 to 85°C	AP2129DN-1.0TRG1	LA	Tape & Reel
		AP2129DN-1.2TRG1	MA	Tape & Reel
		AP2129DN-1.8TRG1	LB	Tape & Reel
		AP2129DN-2.6TRG1	MB	Tape & Reel
		AP2129DN-2.8TRG1	LC	Tape & Reel
		AP2129DN-3.0TRG1	MC	Tape & Reel
		AP2129DN-3.3TRG1	LD	Tape & Reel

BCD Semiconductor's products, as designated with "G1" suffix in the part number, are RoHS compliant and Green.

**300mA HIGH SPEED, EXTREMELY LOW NOISE CMOS LDO REGULATOR****AP2129****Absolute Maximum Ratings (Note 1)**

Parameter	Symbol	Value		Unit
Input Voltage	V_{IN}	6.5		V
Shutdown Input Voltage	V_{CE}	-0.3 to $V_{IN}+0.3$		V
Output Current	I_{OUT}	450		mA
Junction Temperature	T_J	150		°C
Storage Temperature Range	T_{STG}	-65 to 150		°C
Lead Temperature (Soldering, 10sec)	T_{LEAD}	260		°C
Thermal Resistance (Junction to Ambient)	θ_{JA}	DFN-1.5x2-6	100	°C/W
		SOT-23-5	250	
ESD (Human Body Model)	ESD	6000		V
ESD (Machine Model)	ESD	200		V

Note 1: Stresses greater than those listed under "Absolute Maximum Ratings" may cause permanent damage to the device. These are stress ratings only, and functional operation of the device at these or any other conditions beyond those indicated under "Recommended Operating Conditions" is not implied. Exposure to "Absolute Maximum Ratings" for extended periods may affect device reliability.

Recommended Operating Conditions

Parameter	Symbol	Min	Max	Unit
Input Voltage	V_{IN}	1.8	6	V
Operating Ambient Temperature Range	T_A	-40	85	°C



300mA HIGH SPEED, EXTREMELY LOW NOISE CMOS LDO REGULATOR AP2129

Electrical Characteristics

AP2129-1.0/1.2/1.8/2.6/2.8/3.0/3.3 Electrical Characteristics

(C_{IN}=1μF, C_{OUT}=1μF, Bold typeface applies over -40°C≤T_J≤85°C, unless otherwise specified.)

Parameter	Symbol	Conditions	Min	Typ	Max	Unit	
Output Voltage	V _{OUT}	V _{IN} =V _{OUT} +1V, (Note 2) 1mA≤I _{OUT} ≤300mA	98%* V _{OUT}		102%* V _{OUT}	V	
Input Voltage	V _{IN}		1.8		6	V	
Maximum Output Current	I _{OUT(MAX)}			450		mA	
Load Regulation	$\frac{\Delta V_{OUT}}{(\Delta I_{OUT} \cdot V_{OUT})}$	V _{IN} -V _{OUT} =1V, (Note 2) 1mA≤I _{OUT} ≤300mA			1.5	%/A	
Line Regulation	$\frac{\Delta V_{OUT}}{(\Delta V_{IN} \cdot V_{OUT})}$	V _{OUT} +0.5V≤V _{IN} ≤6V, (Note 2) I _{OUT} =30mA			0.06	%/V	
Dropout Voltage	V _{DROP}	V _{OUT} =1.0V, I _{OUT} =300mA		800		mV	
		V _{OUT} =1.2V, I _{OUT} =300mA		600			
		V _{OUT} =1.8V, I _{OUT} =300mA		600	700		
		V _{OUT} =2.6V/2.8V/3.0V/3.3V, I _{OUT} =300mA		170	300		
Quiescent Current	I _Q	V _{IN} =V _{OUT} +1V, I _{OUT} =0mA		60	90	μA	
Standby Current	I _{STD}	V _{IN} =V _{OUT} +1V, V _{SHUTDOWN} in off mode		0.1	1.0	μA	
Power Supply Rejection Ratio	PSRR	Ripple 1Vp-p V _{IN} =V _{OUT} +1V	f=100Hz		65		dB
			f=1KHz		65		dB
			f=10KHz		45		dB
Output Voltage Temperature Coefficient	$\frac{(\Delta V_{OUT}/V_{OUT})}{\Delta T}$	I _{OUT} =30mA, -40°C≤T _J ≤85°C		±100		ppm/°C	
Output Current Limit	I _{LIMIT}	V _{IN} -V _{OUT} =1V, V _{OUT} =0.98*V _{OUT}		400		mA	
Short Current Limit	I _{SHORT}	V _{OUT} =0V		50		mA	
Soft Start Time	t _{UP}			50		μs	
RMS Output Noise	V _{NOISE}	T _A =25°C, 10Hz ≤f≤100kHz		60		μVrms	
Shutdown "High" Voltage		Shutdown input voltage "High"	1.5		6	V	
Shutdown "Low" Voltage		Shutdown input voltage "Low"	0		0.4	V	
V _{OUT} Discharge MOSFET R _{DS(ON)}		Shutdown input voltage "Low"		60		Ω	
Shutdown Pull Down Resistance				3		MΩ	
Thermal Shutdown				165		°C	
Thermal Shutdown Hysteresis				30		°C	
Thermal Resistance	θ _{JC}	DFN-1.5x2-6		20		°C/W	
		SOT-23-5		150			

Note 2: V_{IN}=2.8V for 1.0 and 1.2 version



300mA HIGH SPEED, EXTREMELY LOW NOISE CMOS LDO REGULATOR AP2129

Electrical Characteristics (Continued)
AP2129-ADJ Electrical Characteristics

($C_{IN}=1\mu F$, $C_{OUT}=1\mu F$, Bold typeface applies over $-40^{\circ}C \leq T_J \leq 85^{\circ}C$, unless otherwise specified.)

Parameter	Symbol	Conditions	Min	Typ	Max	Unit
Reference Voltage	V_{REF}	$V_{IN}=1.8V$ $1mA \leq I_{OUT} \leq 300mA$	0.748	0.8	0.816	V
Input Voltage	V_{IN}		1.8		6	V
Maximum Output Current	$I_{OUT(MAX)}$			450		mA
Load Regulation	$\frac{\Delta V_{OUT}}{(\Delta I_{OUT} * V_{OUT})}$	$V_{IN}-V_{OUT}=1V$, $1mA \leq I_{OUT} \leq 300mA$			1.5	%/A
Line Regulation	$\frac{\Delta V_{OUT}}{(\Delta V_{IN} * V_{OUT})}$	$V_{OUT}+0.5V \leq V_{IN} \leq 6V$ $I_{OUT}=30mA$			0.06	%/V
Quiescent Current	I_Q	$V_{IN}=V_{OUT}+1V$, $I_{OUT}=0mA$		60	90	μA
Standby Current	I_{STD}	$V_{IN}=V_{OUT}+1V$, $V_{SHUTDOWN}$ in off mode		0.1	1.0	μA
Power Supply Rejection Ratio	PSRR	Ripple 1Vp-p $V_{IN}=V_{OUT}+1V$	$f=100Hz$		65	dB
			$f=1KHz$		65	dB
			$f=10KHz$		45	dB
Output Voltage Temperature Coefficient	$\frac{(\Delta V_{OUT}/V_{OUT})}{\Delta T}$	$I_{OUT}=30mA$, $-40^{\circ}C \leq T_J \leq 85^{\circ}C$		± 100		ppm/ $^{\circ}C$
Output Current Limit	I_{LIMIT}			400		mA
Short Current Limit	I_{SHORT}	$V_{OUT}=0V$		50		mA
Soft Start Time	t_{UP}			50		μs
RMS Output Noise	V_{NOISE}	$T_A=25^{\circ}C$, $10Hz \leq f \leq 100kHz$		60		μV_{rms}
Shutdown "High" Voltage		Shutdown input voltage "High"	1.5		6	V
Shutdown "Low" Voltage		Shutdown input voltage "Low"	0		0.4	V
V_{OUT} Discharge MOSFET $R_{DS(ON)}$		Shutdown input voltage "Low"		60		Ω
Shutdown Pull Down Resistance				3		M Ω
Thermal Shutdown				165		$^{\circ}C$
Thermal Shutdown Hysteresis				30		$^{\circ}C$
Thermal Resistance	θ_{JC}	DFN-1.5x2-6		20		$^{\circ}C/W$
		SOT-23-5		150		



300mA HIGH SPEED, EXTREMELY LOW NOISE CMOS LDO REGULATOR AP2129

Typical Performance Characteristics

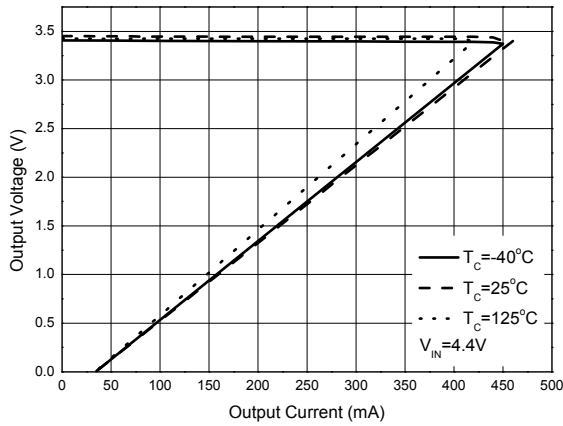

Figure 4. Output Voltage vs. Output Current

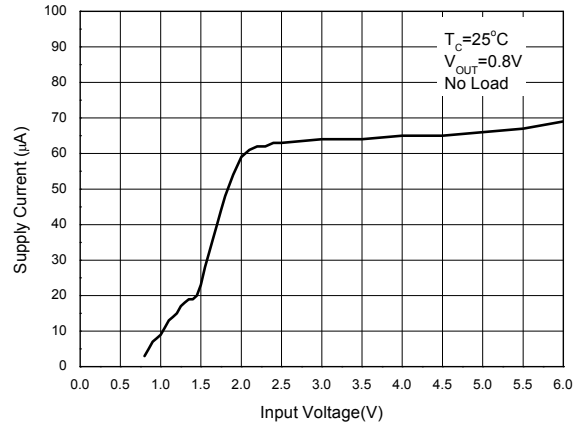

Figure 5. Supply Current vs. Input Voltage

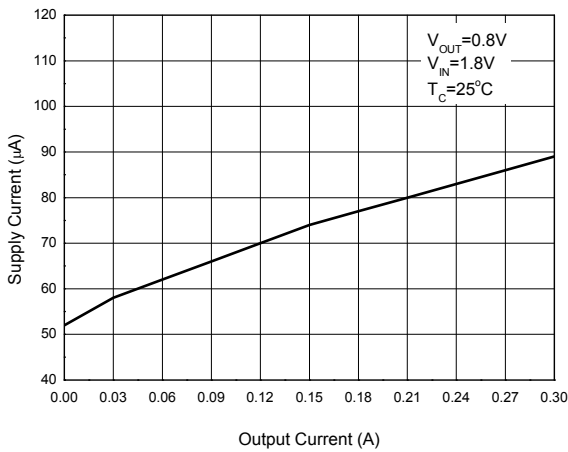

Figure 6. Supply Current vs. Output Current

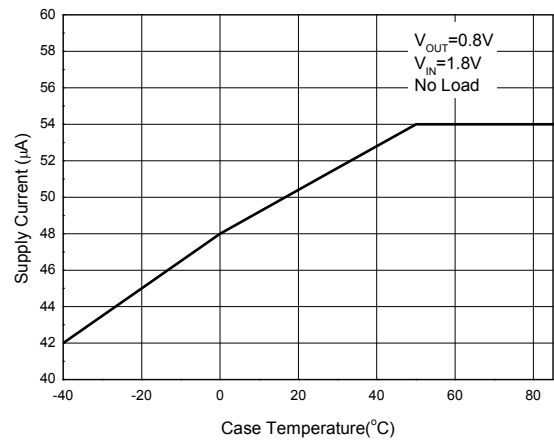

Figure 7. Supply Current vs. Case Temperature



300mA HIGH SPEED, EXTREMELY LOW NOISE CMOS LDO REGULATOR AP2129

Typical Performance Characteristics (Continued)

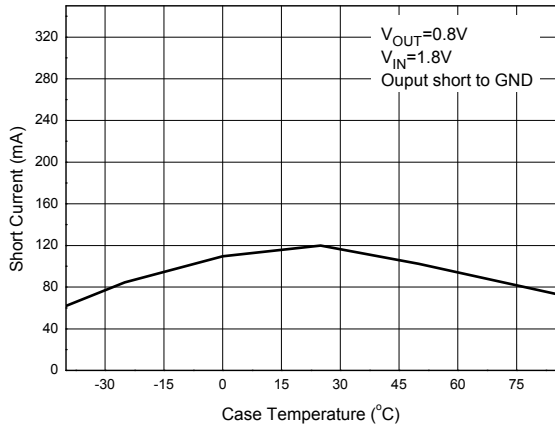

Figure 8. Short Current vs. Case Temperature

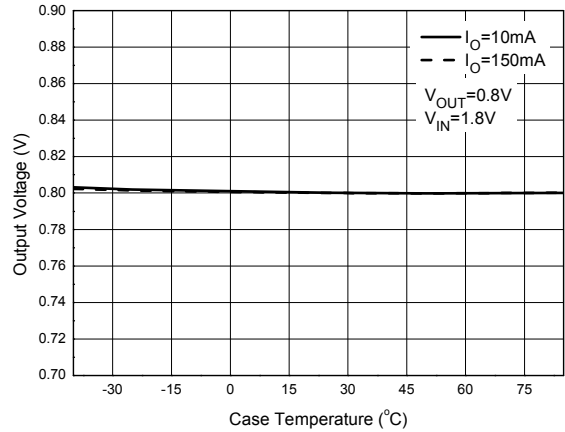

Figure 9. Output Voltage vs. Case Temperature

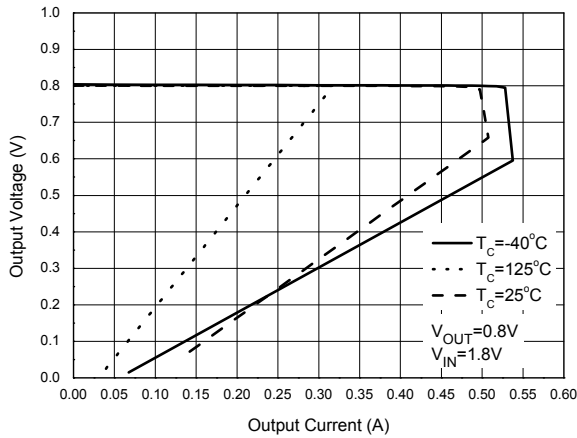

Figure 10. Output Voltage vs. Output Current

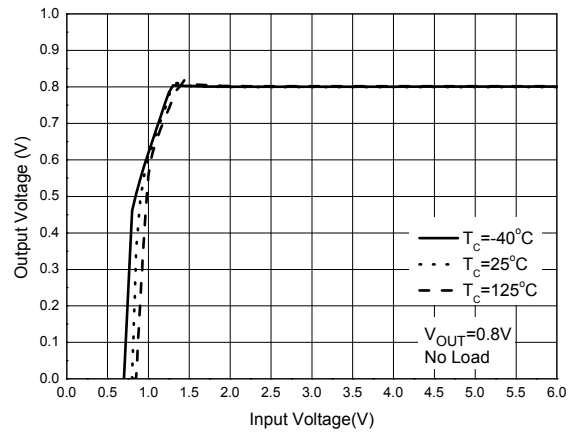

Figure 11. Output Voltage vs. Input Voltage



300mA HIGH SPEED, EXTREMELY LOW NOISE CMOS LDO REGULATOR AP2129

Typical Performance Characteristics (Continued)

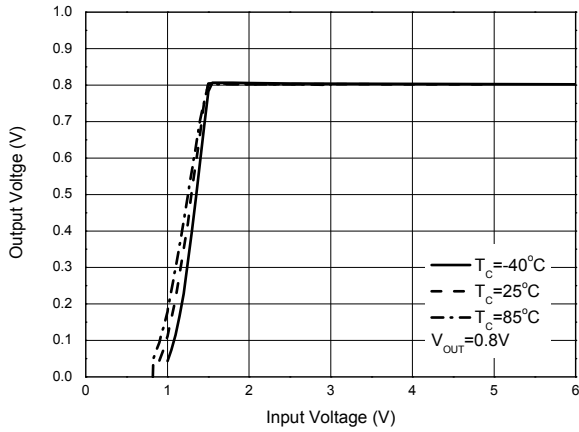

Figure 12. Output Voltage vs. Input Voltage ($I_{OUT}=300\text{mA}$)

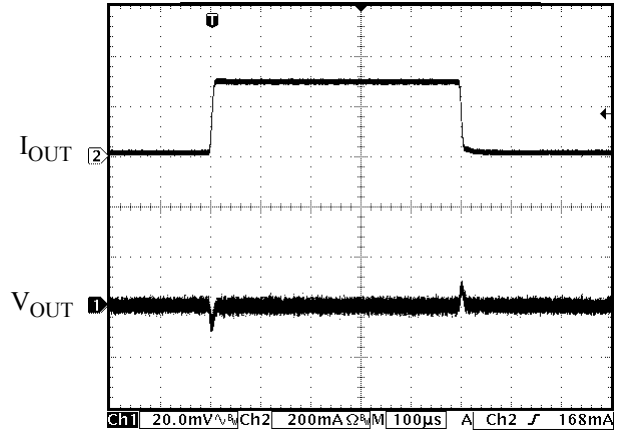

Figure 13. Load Transient (Conditions: $C_{IN}=C_{OUT}=1\mu\text{F}$, $V_{IN}=2.5\text{V}$, $V_{OUT}=0.8\text{V}$)

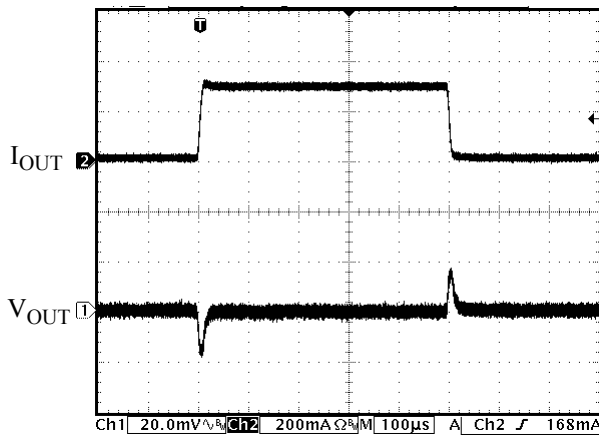

Figure 14. Load Transient (Conditions: $C_{IN}=C_{OUT}=1\mu\text{F}$, $V_{IN}=4.4\text{V}$, $V_{OUT}=3.3\text{V}$)

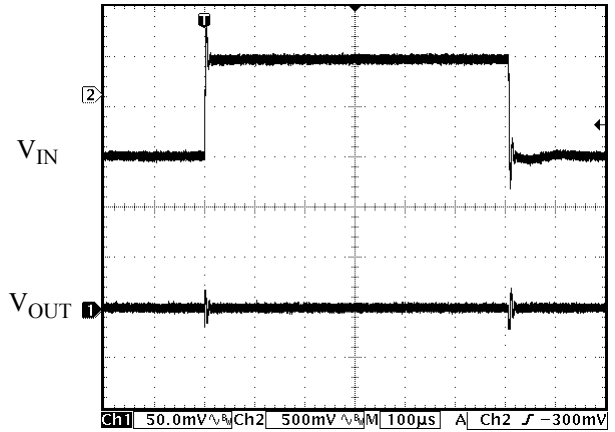

Figure 15. Line Transient (Conditions: $I_{OUT}=30\text{mA}$, $C_{IN}=C_{OUT}=1\mu\text{F}$, $V_{IN}=2.5$ to 3.5V , $V_{OUT}=0.8\text{V}$)



300mA HIGH SPEED, EXTREMELY LOW NOISE CMOS LDO REGULATOR AP2129

Typical Performance Characteristics (Continued)

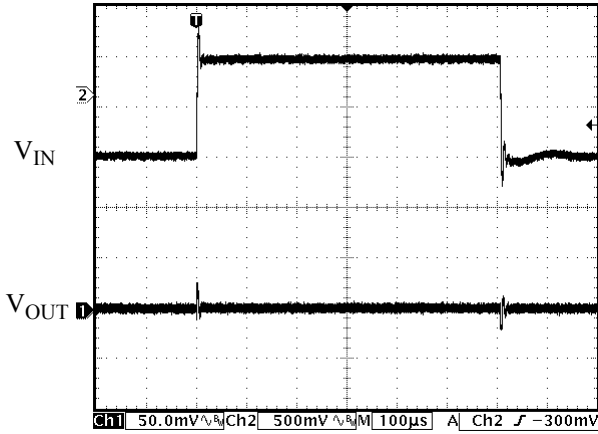

Figure 16. Line Transient
(Conditions: $I_{OUT}=30\text{mA}$, $C_{IN}=C_{OUT}=1\mu\text{F}$,
 $V_{IN}=4$ to 5V , $V_{OUT}=3.3\text{V}$)

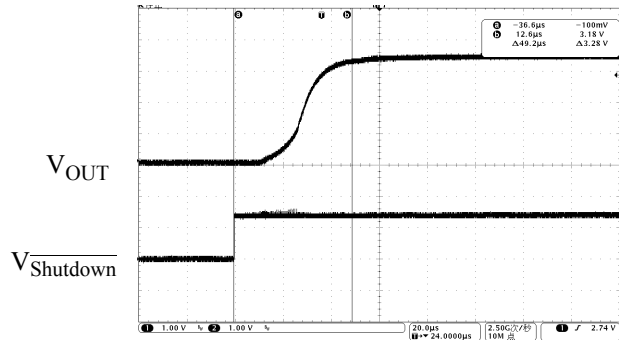

Figure 17. Soft Start Time
(Conditions: $I_{OUT}=0\text{mA}$, $C_{IN}=C_{OUT}=1\mu\text{F}$,
 $V_{Shutdown}=0$ to 2V , $V_{OUT}=3.3\text{V}$)

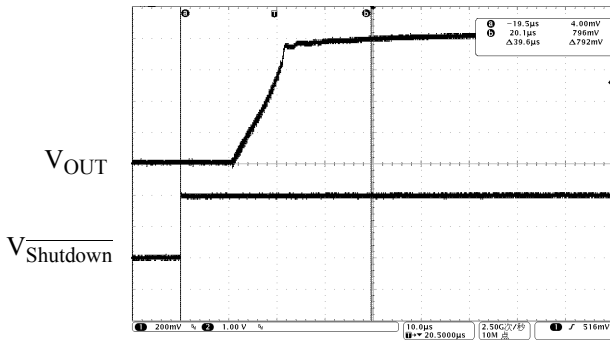

Figure 18. Soft Start Time
(Conditions: $I_{OUT}=0\text{mA}$, $C_{IN}=C_{OUT}=1\mu\text{F}$,
 $V_{Shutdown}=0$ to 2V , $V_{OUT}=0.8\text{V}$)

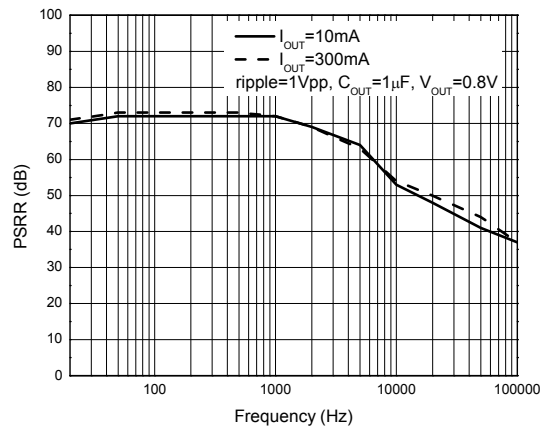

Figure 19. PSRR vs. Frequency



300mA HIGH SPEED, EXTREMELY LOW NOISE CMOS LDO REGULATOR AP2129

Typical Performance Characteristics (Continued)

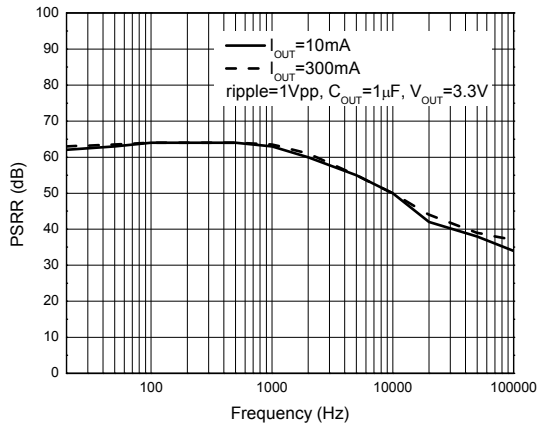

Figure 20. PSRR vs. Frequency

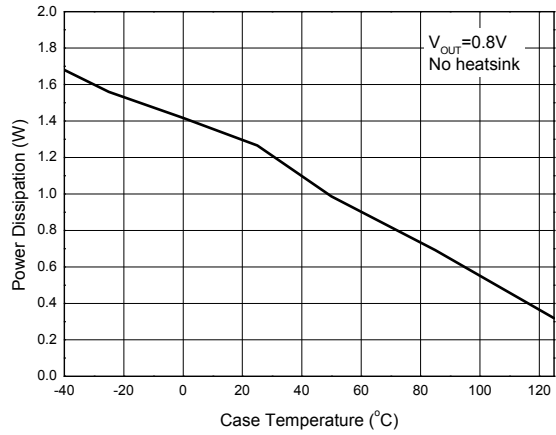
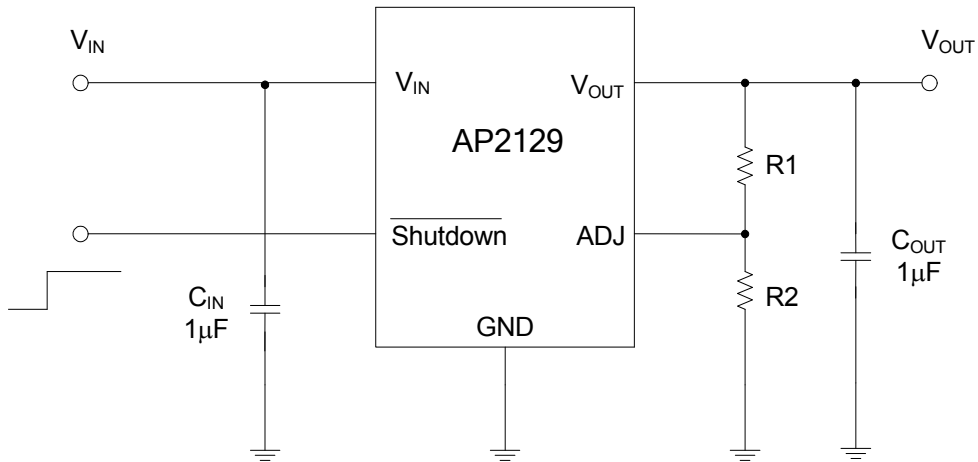

Figure 21. Power Dissipation vs. Case Temperature

300mA HIGH SPEED, EXTREMELY LOW NOISE CMOS LDO REGULATOR AP2129

Typical Application



$$V_{OUT} = 0.8 * (1 + R1/R2) V$$

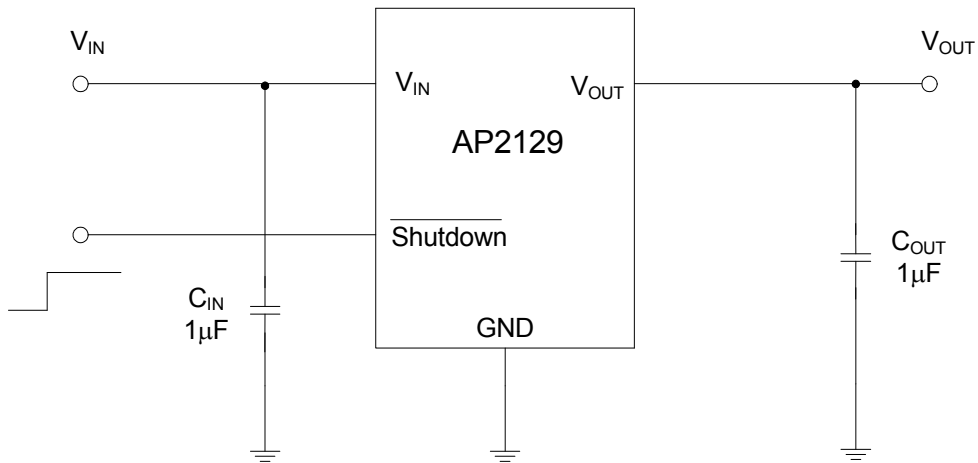

$$V_{OUT} = 1.0V, 1.2V, 1.8V, 2.6V, 2.8V, 3.0V, 3.3V$$

Figure 22. Typical Application of AP2129



300mA HIGH SPEED, EXTREMELY LOW NOISE CMOS LDO REGULATOR AP2129

Mechanical Dimensions

DFN-1.5x2-6

Unit: mm(inch)

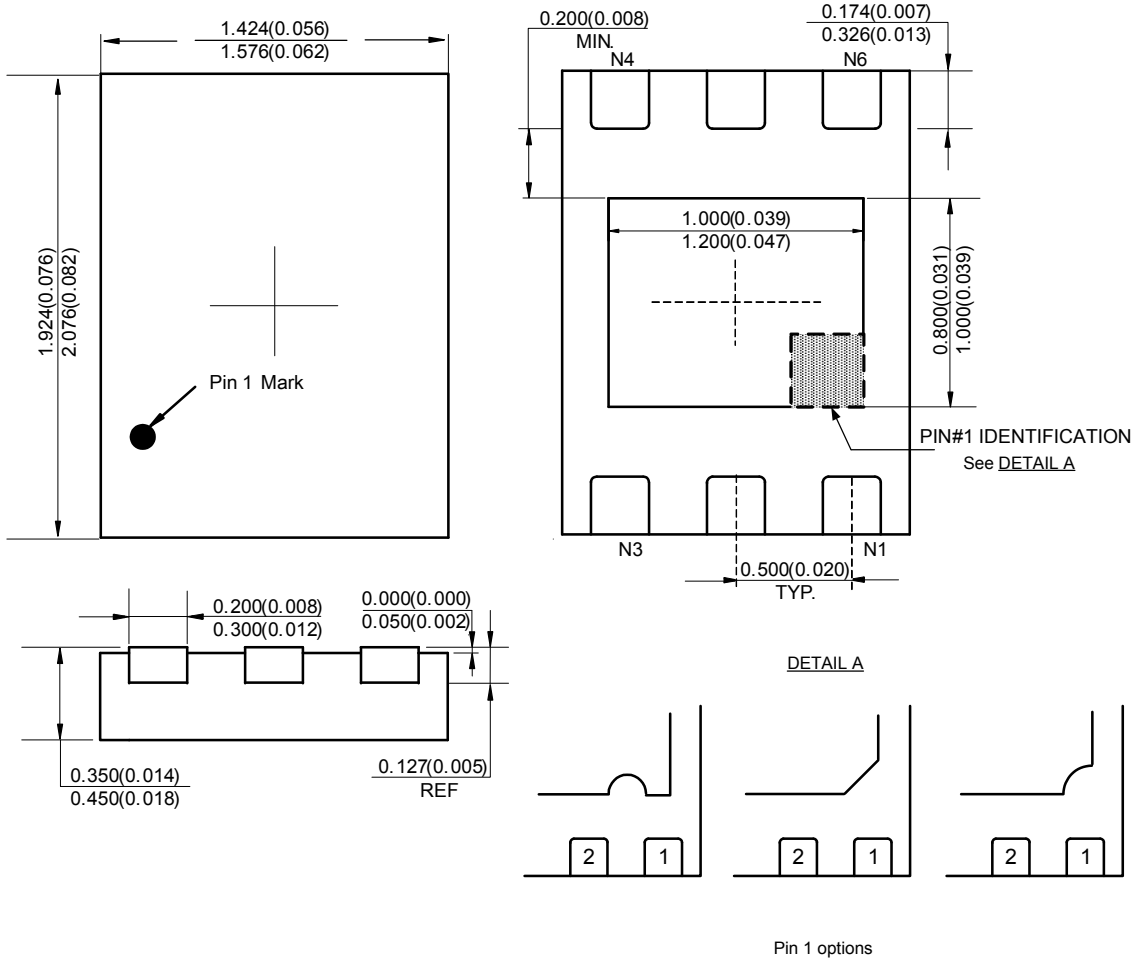



300mA HIGH SPEED, EXTREMELY LOW NOISE CMOS LDO REGULATOR AP2129

Mechanical Dimensions (Continued)

SOT-23-5

Unit: mm(inch)

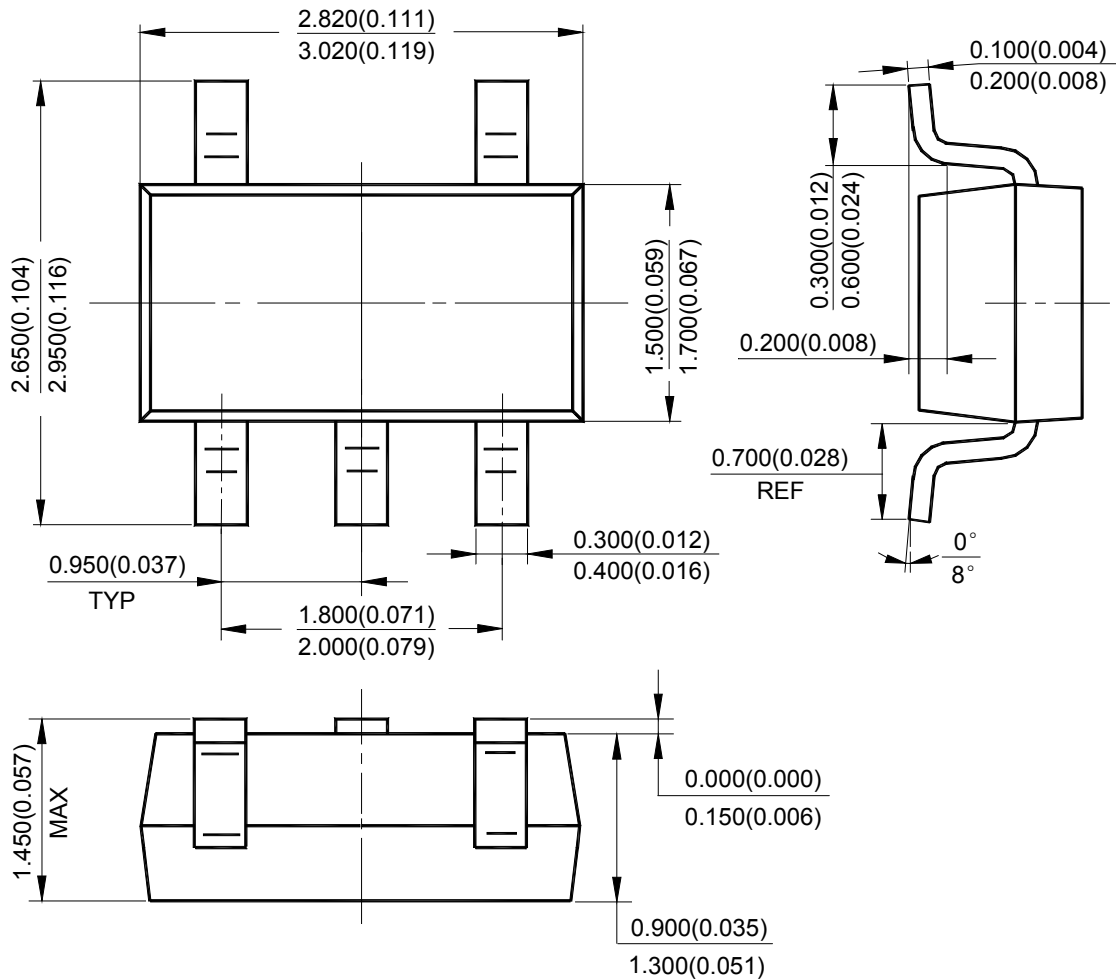



BCD Semiconductor Manufacturing Limited

<http://www.bcdsemi.com>

IMPORTANT NOTICE

BCD Semiconductor Manufacturing Limited reserves the right to make changes without further notice to any products or specifications herein. BCD Semiconductor Manufacturing Limited does not assume any responsibility for use of any its products for any particular purpose, nor does BCD Semiconductor Manufacturing Limited assume any liability arising out of the application or use of any its products or circuits. BCD Semiconductor Manufacturing Limited does not convey any license under its patent rights or other rights nor the rights of others.

MAIN SITE

- Headquarters

BCD Semiconductor Manufacturing Limited

No. 1600, Zi Xing Road, Shanghai Zizhu Science-based Industrial Park, 200241, China
Tel: +86-21-24162266, Fax: +86-21-24162277

- Wafer Fab

Shanghai SIM-BCD Semiconductor Manufacturing Co., Ltd.

800 Yi Shan Road, Shanghai 200233, China
Tel: +86-21-6485 1491, Fax: +86-21-5450 0008

REGIONAL SALES OFFICE

Shenzhen Office

Shanghai SIM-BCD Semiconductor Manufacturing Co., Ltd., Shenzhen Office

Unit A Room 1203, Skyworth Bldg., Gaoxin Ave. 1.S., Nanshan District, Shenzhen, China
Tel: +86-755-8826 7951
Fax: +86-755-8826 7865

Taiwan Office

BCD Semiconductor (Taiwan) Company Limited

4F, 298-1, Rui Guang Road, Nei-Hu District, Taipei, Taiwan
Tel: +886-2-2656 2808
Fax: +886-2-2656 2806

USA Office

BCD Semiconductor Corp.

30920 Huntwood Ave. Hayward, CA 94544, USA
Tel : +1-510-324-2988
Fax: +1-510-324-2788