

NPN Silicon Epitaxial Planar Transistor
for switching and AF amplifier applications.

The transistor is subdivided into four groups O, Y, G and L, according to its DC current gain. As complementary type the PNP transistor

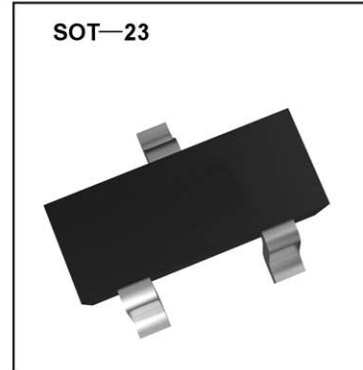

● **Absolute Maximum Ratings ($T_a = 25\text{ }^\circ\text{C}$)**

Parameter	Symbol	Value	Unit
Collector Base Voltage	V_{CBO}	60	V
Collector Emitter Voltage	V_{CEO}	50	V
Emitter Base Voltage	V_{EBO}	5	V
Collector Current	I_C	150	mA
Base Current	I_B	50	mA
Power Dissipation	P_{tot}	200	mW
Junction Temperature	T_j	150	$^\circ\text{C}$
Storage Temperature Range	T_S	-55 to +150	$^\circ\text{C}$

● **Characteristics at $T_{amb}=25\text{ }^\circ\text{C}$**

Parameter	Symbol	Min.	Typ.	Max.	Unit	
DC Current Gain at $V_{CE}=6\text{V}$, $I_C=2\text{mA}$ Current Gain Group	O	h_{FE}	70	-	140	-
	Y	h_{FE}	120	-	240	-
	G	h_{FE}	200	-	400	-
	L	h_{FE}	350	-	700	-
		h_{FE}	25	-	-	-
at $V_{CE}=6\text{V}$, $I_C=150\text{mA}$						
Collector Saturation Voltage at $I_C=100\text{mA}$, $I_B=10\text{mA}$	$V_{CE(sat)}$	-	-	0.25	V	
Base Saturation Voltage at $I_C=100\text{mA}$, $I_B=10\text{mA}$	$V_{BE(sat)}$	-	-	1	V	
Collector Cutoff Current at $V_{CB}=60\text{V}$ at $V_{EB}=5\text{V}$	I_{CBO}	-	-	0.1	μA	
	I_{EBO}	-	-	0.1	μA	
Gain Bandwidth Product at $V_{CE}=10\text{V}$, $I_C=1\text{mA}$	f_T	80	-	-	MHz	
Output Capacitance at $V_{CB}=10\text{V}$, $f=1\text{MHz}$	C_{OB}	-	2	3	pF	
Noise Figure at $V_{CE}=6\text{V}$, $I_C=0.1\text{mA}$, $f=1\text{KHz}$, $R_G=10\text{K}\Omega$	NF	-	1	1	dB	

SK MAKE CONSCIOUS PRODUCT

CONSCIOUS PRODUCTS BEGIN WITH CONSCIOUS PEOPLE



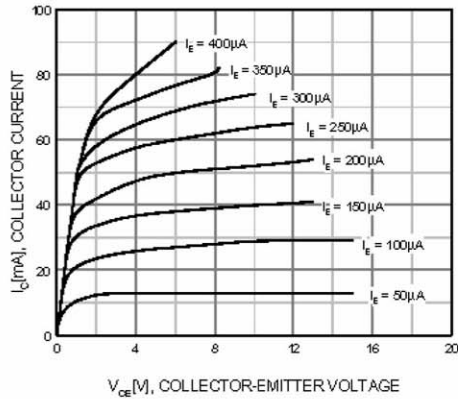

Figure 1. Static Characteristic

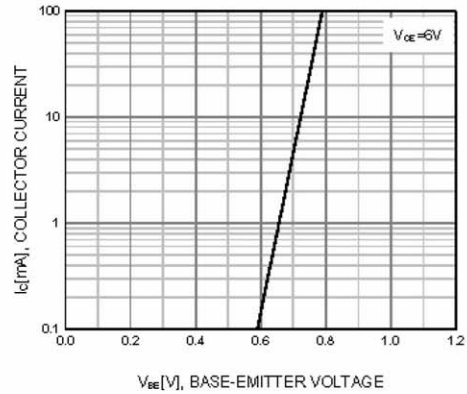

Figure 2. Transfer Characteristic

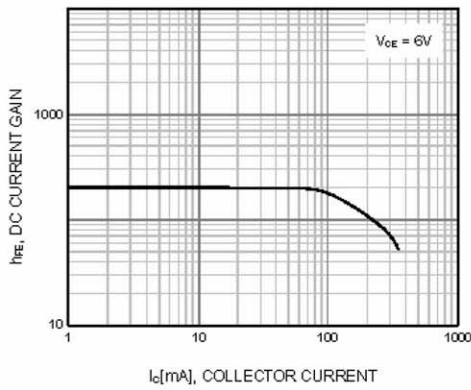

Figure 3. DC current Gain

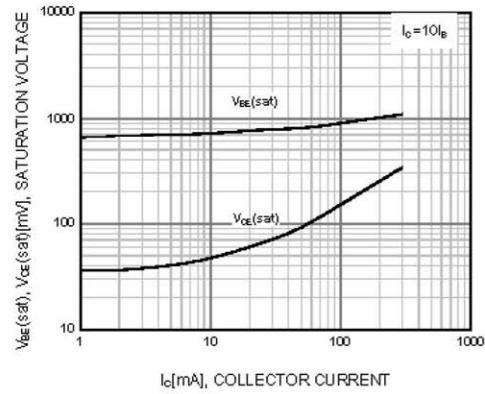

Figure 4. Base-Emitter Saturation Voltage
Collector-Emitter Saturation Voltage

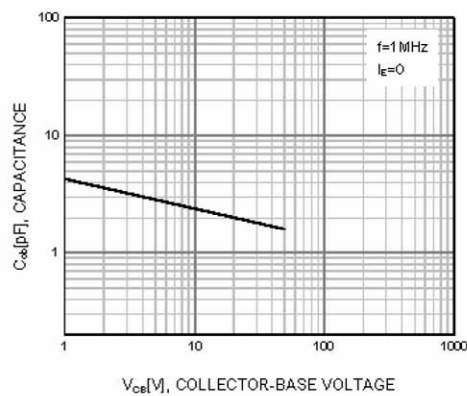

Figure 5. Output Capacitance

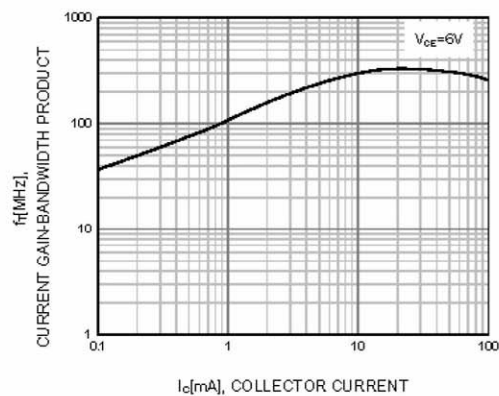

Figure 6. Current Gain Bandwidth Product

SK MAKE CONSCIOUS PRODUCT
CONSCIOUS PRODUCTS BEGIN WITH CONSCIOUS PEOPLE

