

**Feature:**

- Water clear lens
- Package in tape and reel
- Ultra bright 0606 LED package
- GaAsP technology for Yellow
- GaP technology for Yellow-Green

**Description:**

These ultra bright 0606 YYG LEDs have a height profile of 0.80mm. Combination of high brightness output and small footprint, these LEDs are ideal for keypad backlighting, status indication, and color mixing applications.

**Application:**

- Status indication
- Back lighting application

**Certification & Compliance:**

- TS16949
- ISO9001
- RoHS Compliant



**Dimension:**

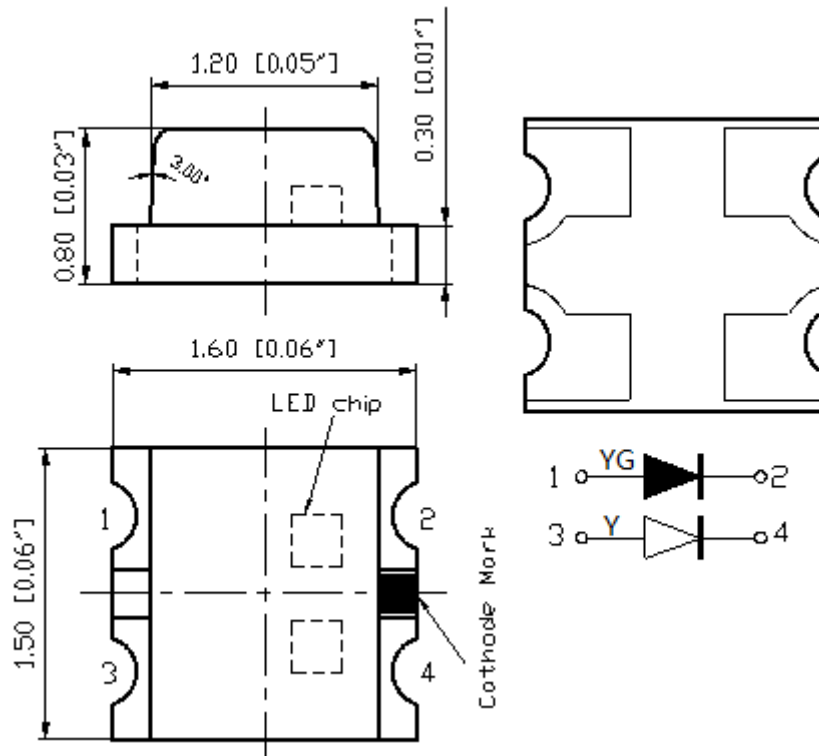

Units: mm / tolerance = +/-0.1mm

**Electrical / Optical Characteristic** (T=25 °C)

Product	Color	I <sub>F</sub> (mA)	V <sub>F</sub> (V)		λ <sub>D</sub> (nm)			I <sub>V</sub> (mcd)	
			Typ.	Max.	Min.	Typ.	Max.	min	typ.
QBLP600-YYG	Yellow	20	2.1	2.6	--	590	--	7	10
	Yellow-Green	20	2.1	2.6	--	573	--	9	12

**Absolute Maximum Rating**

Part #	P <sub>d</sub> (mW)	I <sub>F</sub> (mA)	I <sub>FP</sub> (mA)*	V <sub>R</sub> (V)	T <sub>OP</sub> (°C)	T <sub>ST</sub> (°C)	T <sub>SOL</sub> (°C)**
GaAsP	80	30	125	5	-40 - 85	-40 - 100	260
GaP	85	30	125	5	-40 - 85	-40 - 100	260

\*Duty 1/10 @ 10KHz

\*\* IR Reflow for no more than 10 sec @ 260 °C

**Characteristic Curves:**

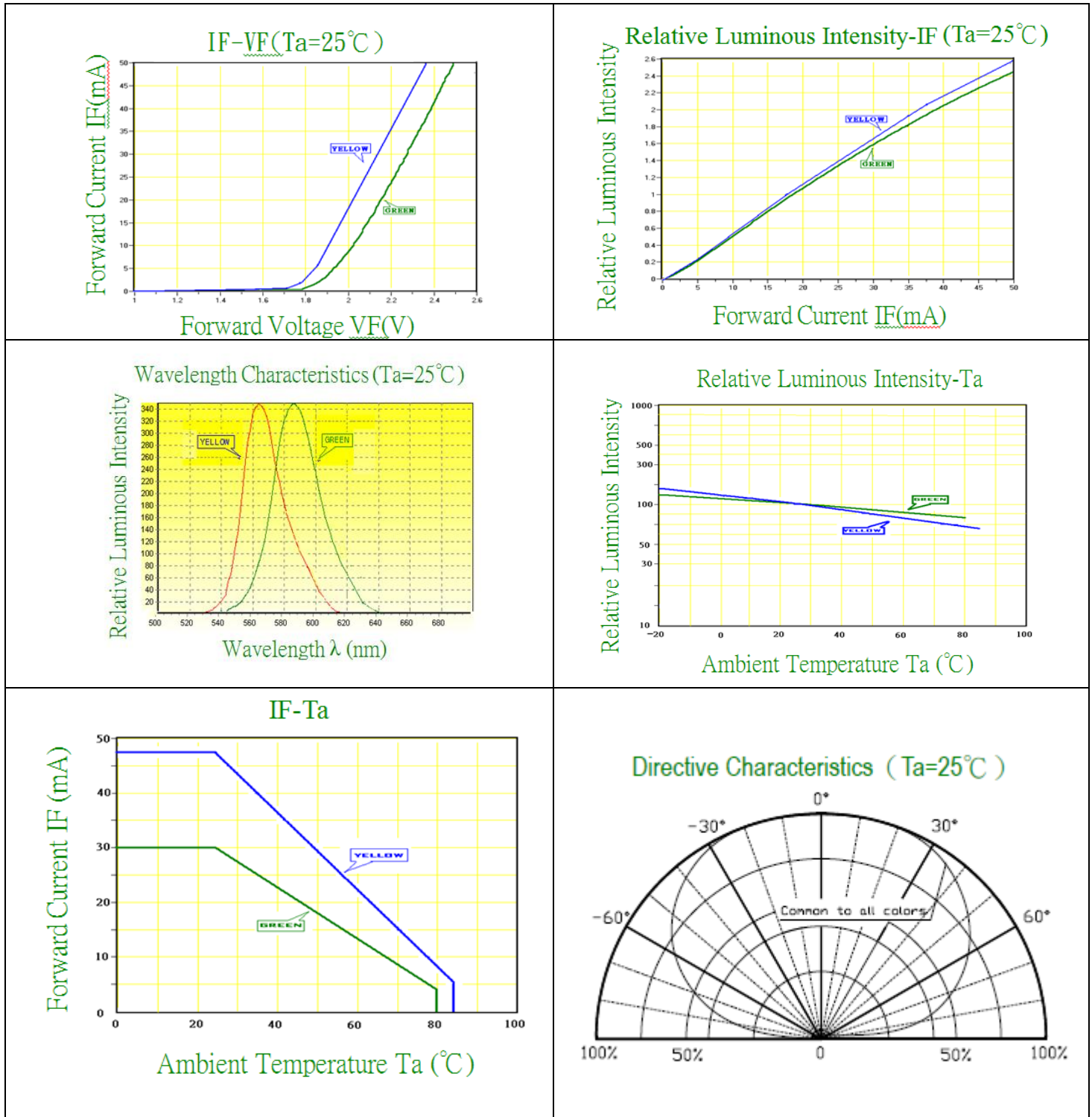

**Solder Profile & Footprint:**

- Recommended tin glue specifications: melting temperature in the range of 178~192 °C
- The recommended reflow soldering profile is as follows (temperatures indicated are as measured on the surface of the LED resin):

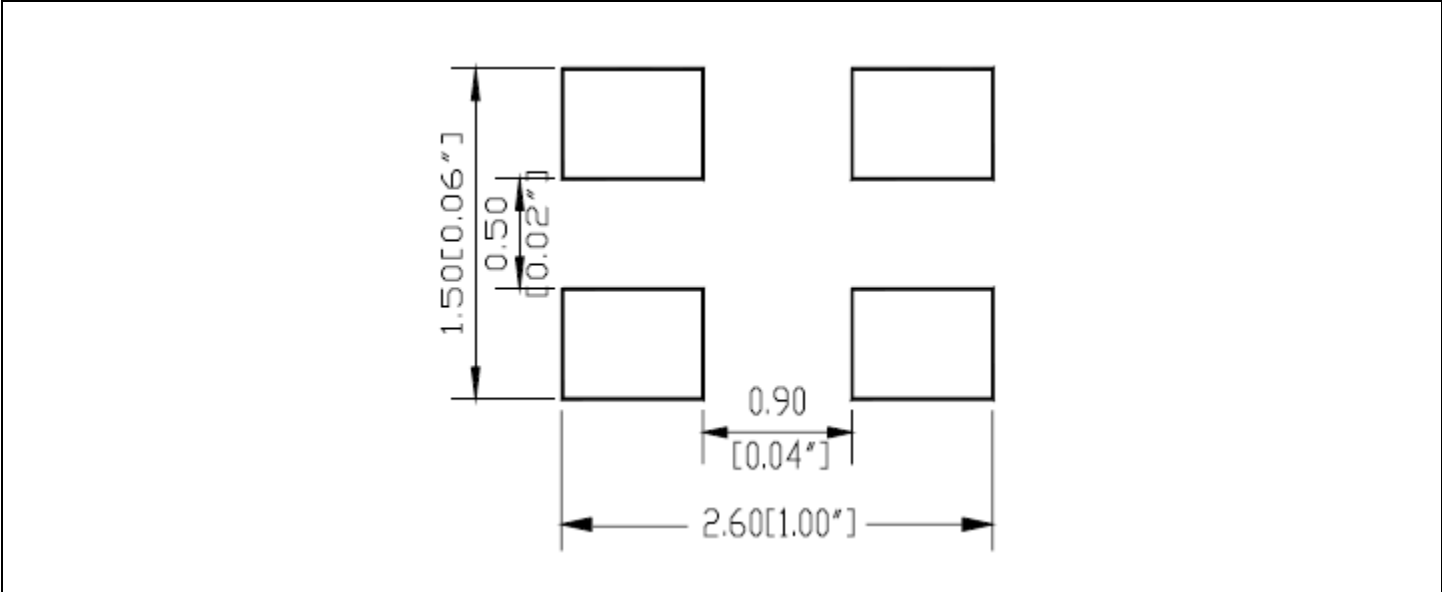
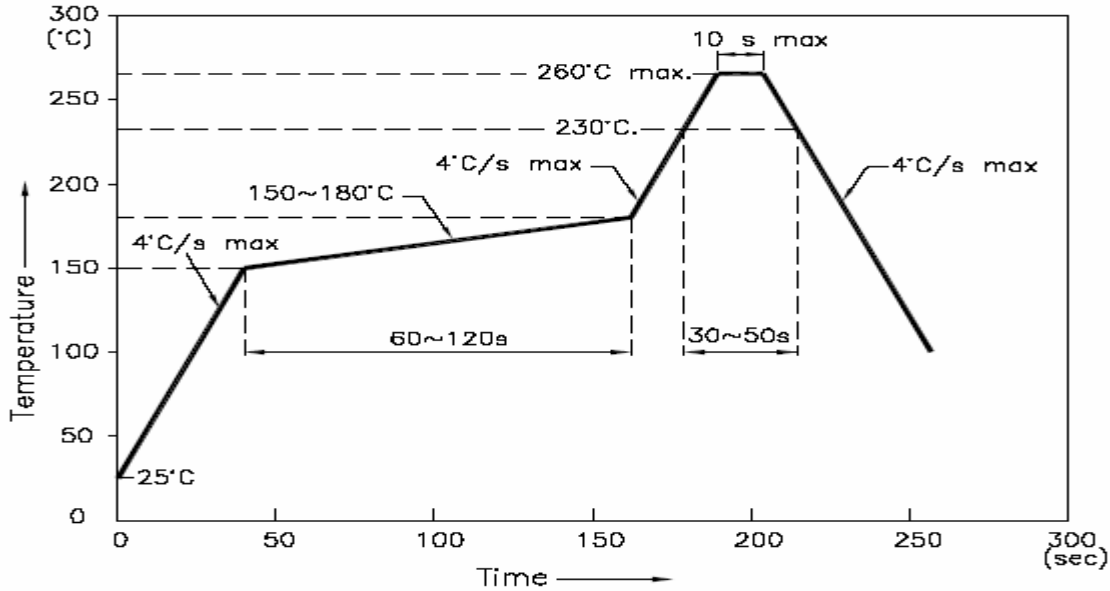

Units: mm

tolerance: +/- 0.1mm

**Packing:**

**Reel Dimension:**

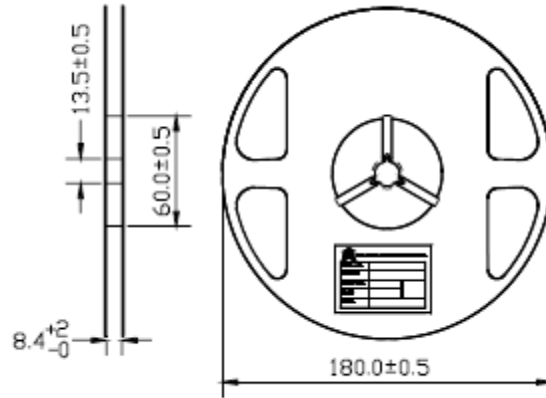

**Tape Dimension:**

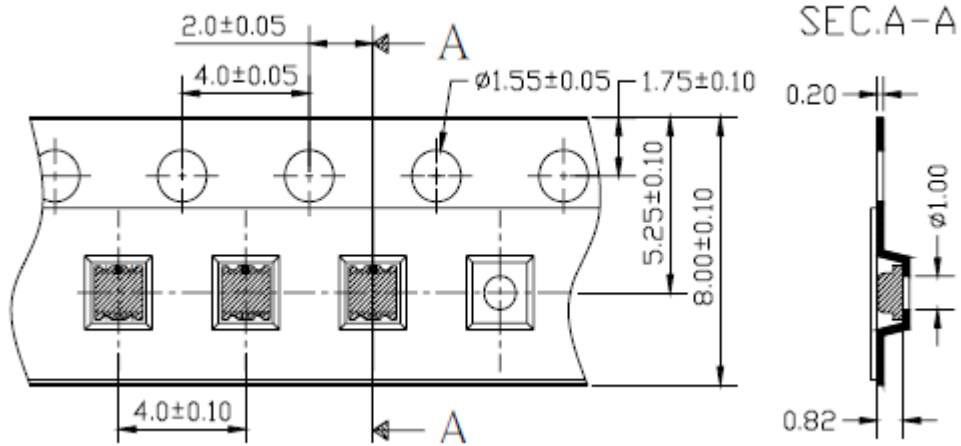

(Unit in mm)

Product: QBLP600-YYG	Date: June 25, 2011	Page 5 of 7
	Version# 1.0	

**Labeling:**

<span style="font-size: 1.2em; font-weight: bold; margin: 0 10px;">QT-Brightek</span>
Part No: _____
Customer P/N: _____
Item: _____
Q'ty: _____
Vf: _____
Iv: _____
WI: _____
Date: _____
<b>Made in China</b>

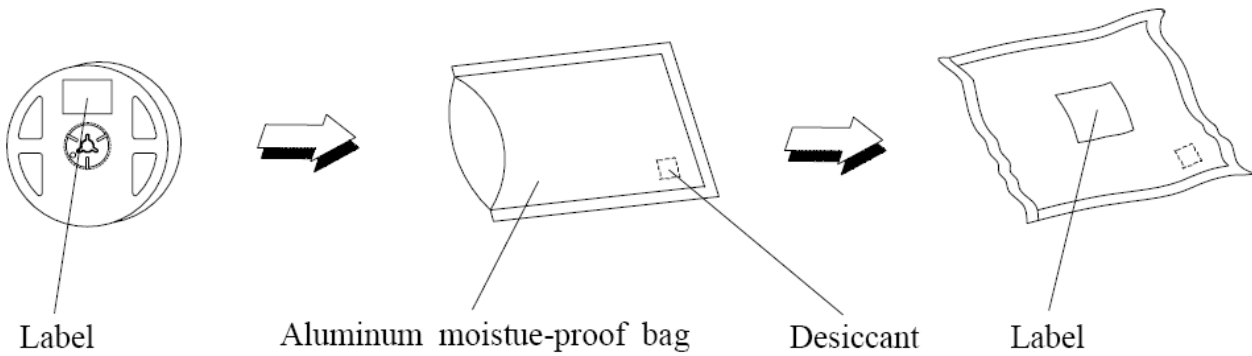

**Ordering Information:**

Part #	Orderable Part #	Spec Range	Quantity per reel
QBLP600-YYG	QBLP600-YYG	Standard Spec	4,000 units

**Revision History:**

Description:	Revision #	Revision Date
New Release of QBLP600-YYG	V1.0	06/25/2011